

ComColor GL Series

9730/9730R
7430/7430R

Please start by reading this guide.
It describes basic operations.

Quick Guide



CAUTION

The "Safety Precautions" are provided in the User's Guide.
Be sure to read through them prior to use.
After reading this guide, keep it in handy for future reference.

Preface

Thank you for your purchase of a ComColor GL series product.

This ComColor GL series product is a network-compatible high-speed color printer that uses inkjet technology. The machine comes with oil-based ink excellent in color performance. Five colors of ink, cyan, magenta, yellow, black, and gray are used to reproduce smooth expression of gradations.

Besides, the machine provides various functions such as output of data and management of the printer from a computer, copying and scanning paper originals*, post-processing (staple, punch, etc.)*, and high capacity feeding or stacking*.

* Available when the machine is in combination with the relevant type of optional equipment.

About the Guides

The following manuals are included with this machine.



Quick Guide (this guide)

This guide describes basic machine operations and how to replace consumables. Keep this guide handy, such as near the machine, for easy reference. For a detailed explanation of each function, see the "User's Guide".



User's Guide

This guide describes handling precautions and specifications, as well as the operations and settings of each function. Read this guide for a more detailed understanding of the machine.



Administrator's Guide

This guide describes the machine settings and optional equipment to be configured by the administrator.

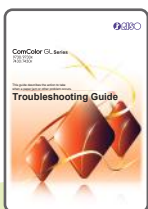

Troubleshooting Guide

This guide describes the actions to take when a paper jam or other problem occurs.

About This Guide

- (1) This guide may not be reproduced in whole or in part without the permission of RISO KAGAKU CORPORATION.
- (2) The contents of this manual may be changed without prior notice due to product improvements.
- (3) RISO KAGAKU CORPORATION shall not be liable for any consequence of using this guide or the machine.

Symbols, Notations, and Screenshots Used in This Guide

Symbols Used in This Guide



Indicates cautions that should be noted for safe use of this machine.



Indicates important items that should be noted or are prohibited.



Indicates useful or additional information.

Names of Keys and Buttons

The names of the following are indicated with square brackets []:

- Hard keys on the operation panel
- Buttons and items displayed on the touch panel screen
- Buttons and items displayed on a computer window

Example: Press the [Stop] key.

Illustrations and Operating Procedures in This Guide

- The operating procedures, screenshots, and illustrations in this guide are for the ComColor GL9730/GL9730R with the optional scanner connected. This guide also assumes that each function is set to the factory setting, and that [Login Setting] is set to [ON].
- The screenshots and illustrations in this guide may vary depending on the machine model and usage environment, including the connected optional equipment.



Selecting jobs and documents

To select a job or document on the touch panel screen, touch the job or document.

You can select all jobs and documents by touching [Select All].

You can deselect the selected items by touching the jobs and documents again.

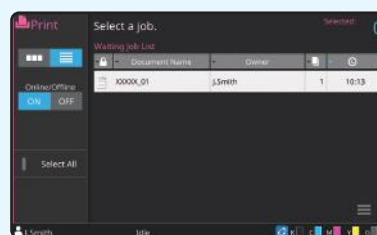
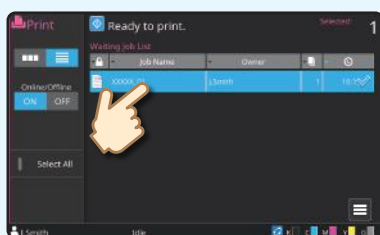

Contents

Preparation

■ About This Machine	4
■ Turning On the Power	6
■ Using the Touch Panel	7
■ Logging In	8
■ Loading Originals	9

Getting Started

■ Copying	10
Loading Orientation of Originals and Paper	11
■ About the Various Copying Functions	12
■ Scanning.....	14
What is the [Favorites] Function?	15
■ Printing	16
How to Print on Envelopes?	18
■ About the Various Printing Functions.....	20
■ Using Storage	22
■ Using a USB Flash Drive.....	24

Routine Care

■ When Paper Runs Out.....	28
■ When Ink Runs Out	30
■ Scanner Care.....	32
Useful Tips	33

About This Machine

This section describes the main parts of the machine.

This Machine

● Scanner (optional)

Use the scanner to copy or scan documents that are read from the platen glass or the ADF.

Copying ▶▶ p.10

Scanning ▶▶ p.14

● Operation panel

Use to perform operations or configure settings.

The viewing angle can be adjusted for improved visibility.

The USB port is located on the left side.

Operation Panel ▶▶ p.5

Using a USB Flash Drive ▶▶ p.24

● Face down tray

Printouts are output face down.

● Front cover

Open when paper is jammed or when replacing an ink cartridge.

When Ink Runs Out ▶▶ p.30

● Standard tray

Load special paper (thick paper, envelopes, etc.) here. You can also load plain paper.

When Paper Runs Out ▶▶ p.28

● Feed trays

Load the paper to be used for printing here. Special paper (thick paper, envelopes, etc.) cannot be loaded.

When Paper Runs Out ▶▶ p.28

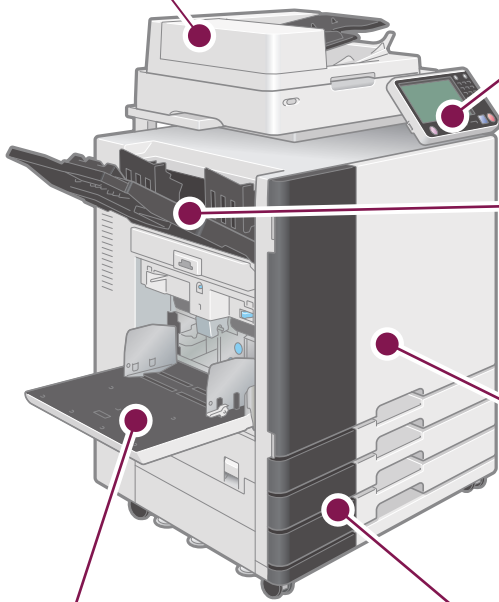

This section describes the main parts used with the operation panel.

Operation Panel

① Touch panel

Use to perform operations or configure settings.

[Using the Touch Panel ▶▶ p.7](#)

④ Numeric keys

Use these keys to enter numbers.

② Wake Up key

This key lights up when this machine is in power saving mode. Pressing this key when it is lit makes the machine ready for operation. Pressing this key when it is not lit puts the machine into sleep state.

[Turning On the Power ▶▶ p.6](#)

⑤ Start key

Press this key to start an operation.

⑥ Login / Logout key

Press this key to log in or log out.

[Logging In ▶▶ p.8](#)

③ Power key

When pressed, the power turns on and the key lights up. To turn off the power, press and hold the key.

[Turning On the Power ▶▶ p.6](#)

⑦ Home key

Press this key to return to the [Home1] screen (initial screen) from the screen for each function.

Turning On the Power

1. Press the [Power] key on the operation panel.

The [Home1] screen is displayed after the startup screen.

-  The machine automatically enters power saving mode if you leave it unattended for some time. Press the [Wake Up] key to operate the machine.

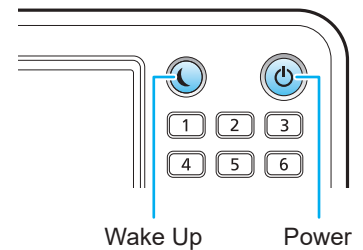

Reducing power consumption

You can reduce the machine's level of power consumption by using the power saving mode. There are two types of states for the power saving mode.

- Backlight OFF
- Sleep (power consumption in the sleep state: [Standard] or [Low])

The amount of time that elapses before the machine enters each state, as well as the power consumption value, are set by the administrator.

When [Low] is selected for [Power Consumption (in Sleep)], the machine consumes lower power than when [Standard] is selected. However, there are some restrictions described below.

- The RISO Console cannot be displayed during sleep state.
- If you print on a network where Wake On LAN does not work, the printer does not wake up automatically. Be sure to specify [MAC Address of the Printer] under the [Environment] tab of the printer driver.

It takes longer for the machine to resume operations after sleep [Low] state than backlight OFF state, but power consumption is lower.

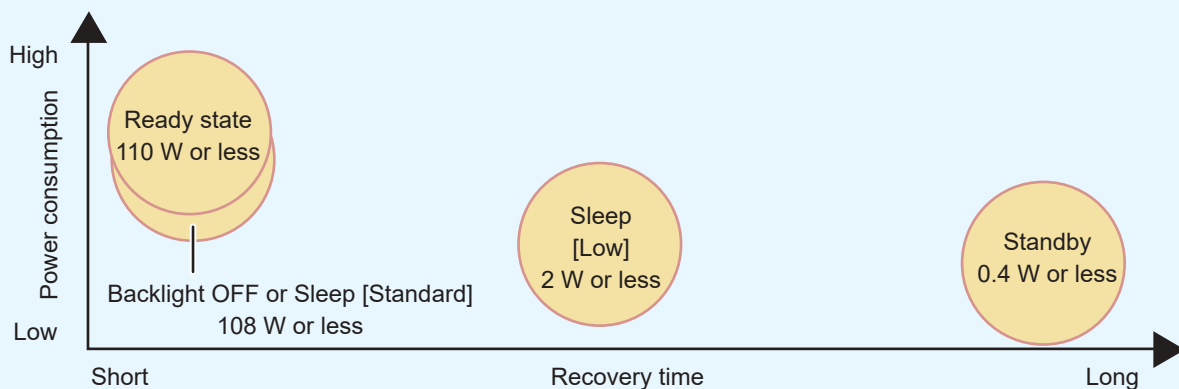

Using the Touch Panel

Touch

Touch a button to select an item.

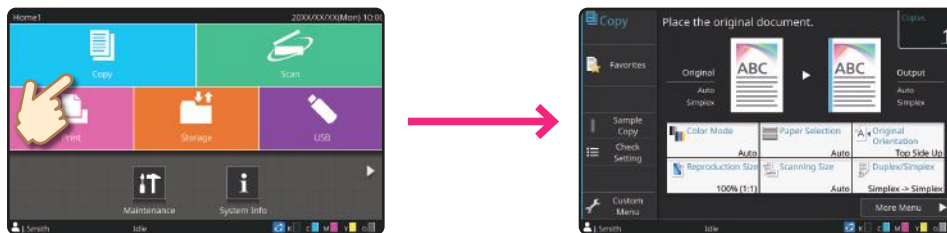

Flick

Flick your finger in any directions on the touch panel.
On the [Home1] screen, flick to switch to the [Home2] screen.

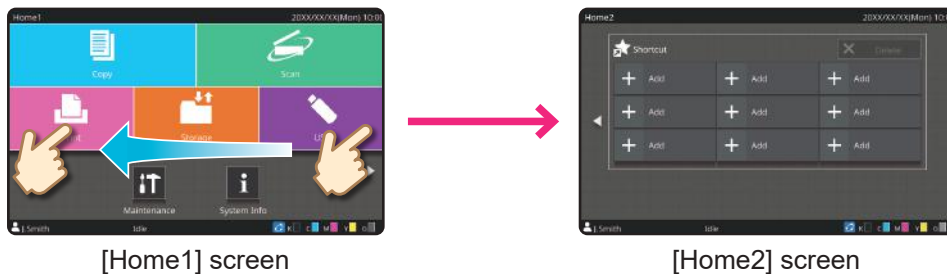

On other screens, flick to scroll the setting items or lists.

Drag

Slide your finger in any directions without lifting from the touch panel.
Drag to scroll through setting items and lists. The scrolling will stop when you remove your finger from the touch panel.

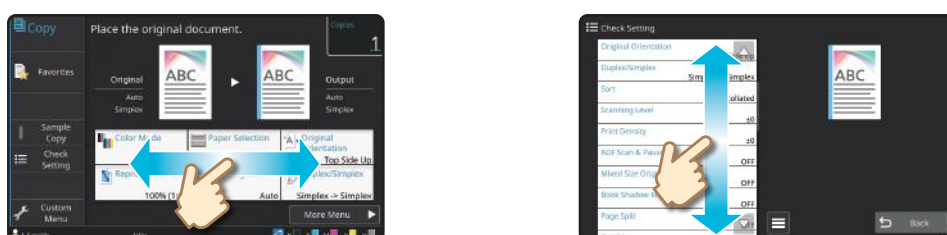

Logging In

Login is required when using functions indicated with the  (lock icon).

1. Press the [Login/Logout] key.

The [Login] screen is displayed.

 The [Login] screen can also be displayed by touching each mode button.

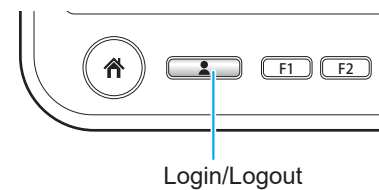

2. Select the user name.

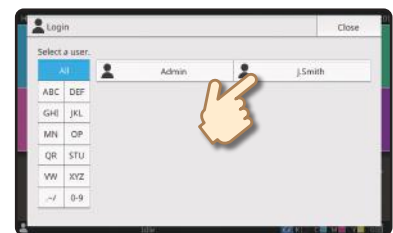

3. Enter your password and touch [Login].

To log out, press the [Login/Logout] key.

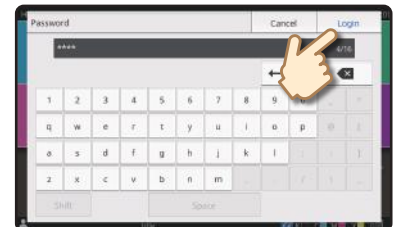

When Logging In for the First Time

Change the temporary password provided by the administrator to a password of your own choosing.

1. Enter the temporary password on the [Password] screen, and touch [Login].
The [Change Password] screen is displayed.
2. Enter the new password and touch [Next].
3. Enter the new password again and touch [OK].

Loading Originals

If you used ink or correction fluid on the original, make sure that it has fully dried before loading it.

Loading in the ADF

1. Load the original so that the side that you want to scan is facing up.

Slide the ADF original guides to match the width of the original.

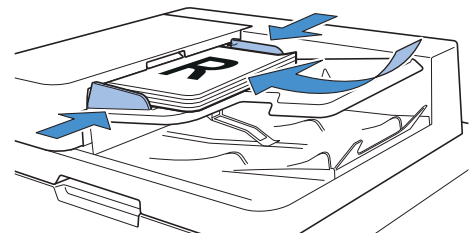

Loading on the Platen Glass

1. Place the original so that the side that you want to scan is facing down.

Align the corner of the original with the arrow at the top left corner of the glass.



If the original is extremely thin, the rear surface may be visible in the image. You can prevent this by placing black paper behind the original.

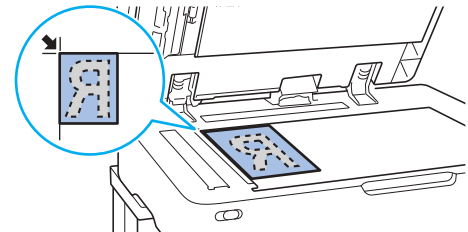

2. Close the original cover.



Types of Originals That Cannot Be Loaded in the ADF

The originals listed below cannot be scanned using the ADF. Set them on the platen glass.

- Originals that have been cut and pasted
- Originals with significant wrinkling or curling
- Bent originals
- Glued originals
- Originals with holes
- Torn originals or originals with jagged edges
- Highly transparent originals such as transparencies or tracing paper (Place a white piece of paper on the back side of the original.)
- Originals with a coating on the front or rear, such as art paper or coated paper
- Thermal paper used in facsimiles or word processors
- Originals with significant bumps on the surface

Copying

1. Load the original.

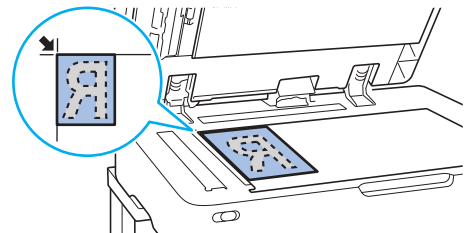
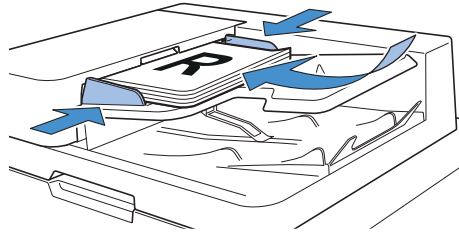

2. Touch [Copy] on the [Home1] screen.



3. Change the settings as needed.

Enter the number of copies using the numeric keys.

About the Various Copying Functions ▶▶ p.12

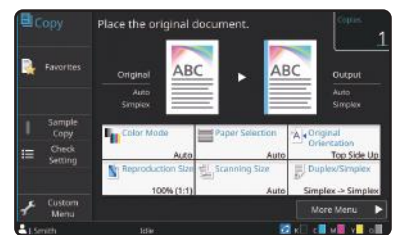

4. Press the [Start] key.

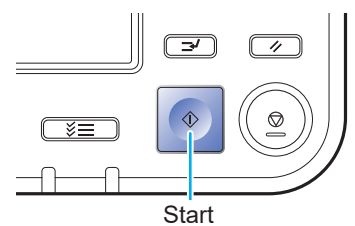



Loading Orientation of Originals and Paper

When you are copying on letterhead paper, envelopes, or other paper with a pre-printed logo, the orientation of the original and paper is important.

The orientation of the original and paper is described below, using an example of copying a single-sided original.

• Example of Loading Envelopes

On the touch panel, set [Original Orientation] to [Top Side Left].

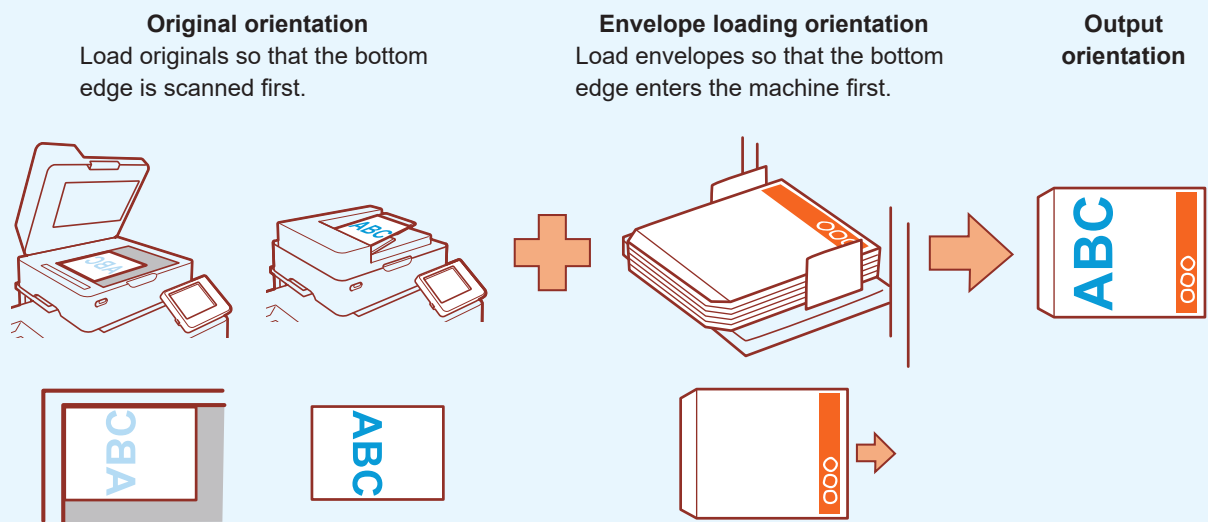

• Example of Loading Letterhead Paper

On the touch panel, set [Original Orientation] to [Top Side Up].

 If the optional stacking tray is connected, outputting printouts face up will become available.

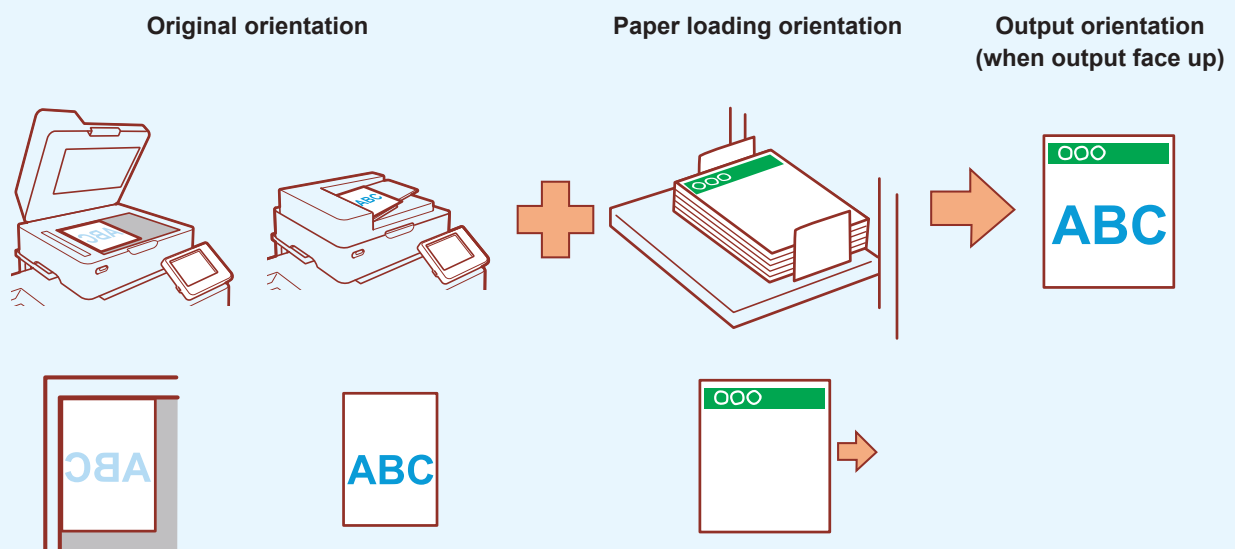

About the Various Copying Functions

Sample Copy

Output one sample before making a large number of copies.
This enables you to check the results and settings.



Scan Job Build

Collectively copy multiple data scanned with different settings as one job.



Mixed Size Original

Scan originals that consist of pages that vary in size.

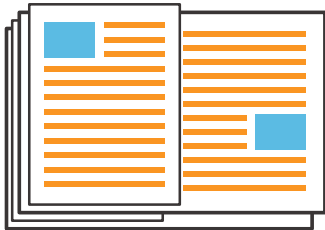

Page Split

When copying double-spread pages of documents such as booklets, split the pages into two parts (left and right) and copy them separately.



Page Border

Add a border line in the margins of the paper.
This enables you to make posters and signs stand out.

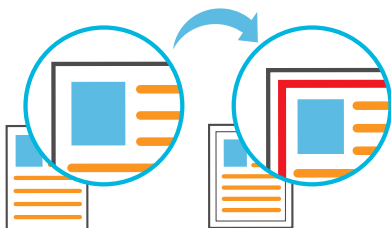
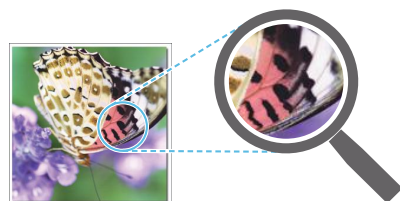

Image Quality

Specify the resolution when scanning originals.
Higher resolution allows you to copy photos and illustrations in high quality.



Original Type

Copy a document with image processing to suit the type of original such as photos and pencil drawings.

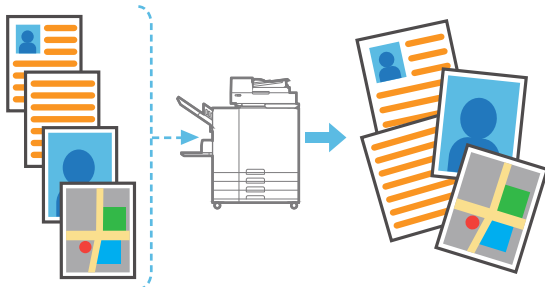

Gamma Correction

Correct the balance of colors the original contains to create more natural colors.

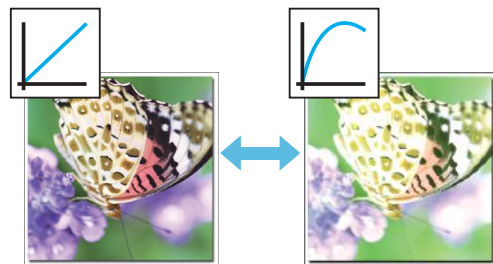

Base Color Level

Make the background color (base color) lighter when scanning an original with a background color.

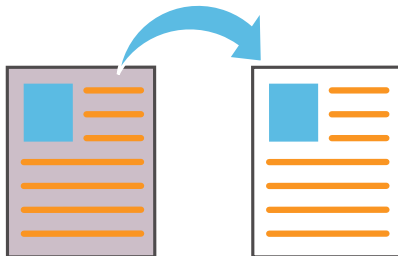

Add Cover

Attach a front or back cover to the document that has been copied.

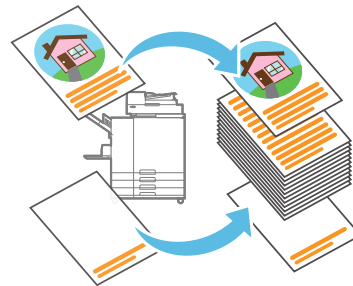

Slip Sheet

Insert a slip sheet between sets of copies. This enables you to quickly separate a large amount of meeting documents or handouts.

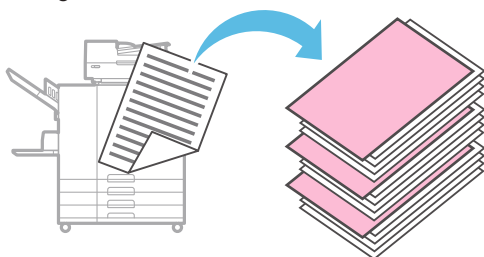

Auto Image Rotation

Automatically rotate the image by 90 degrees so that the original data matches the orientation of the paper.

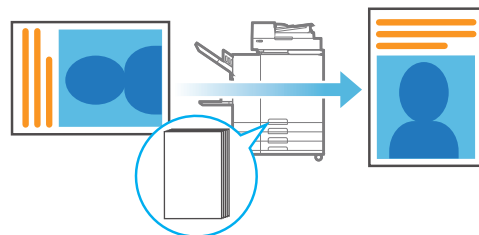

Scanning

You can select either [Mail], [PC], or [Console] as the destination for sending or storing the data. In this section, the procedure for sending the data to a computer is described as an example.

1. Load the original.

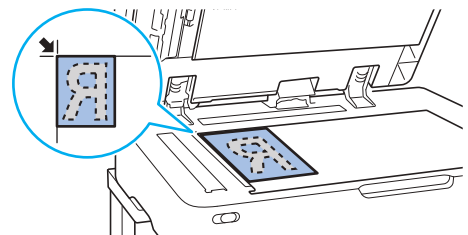
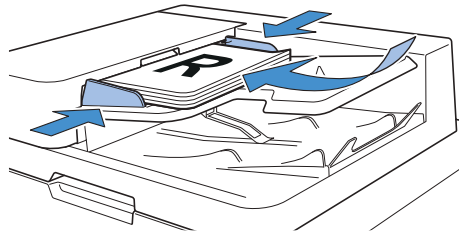

2. Touch [Scan] - [PC] on the [Home] screen.

- Select [Mail] to send the scanned data by e-mail, or select [Console] to save the scanned data to the internal solid state drive (SSD) of this machine.



3. Touch [Destination], and select the destination.

Change the settings as needed.

- For [Mail], touch [Address] to configure the address. For [Console], it is not necessary to configure the destination.

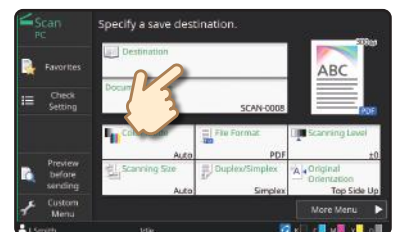

4. Press the [Start] key.

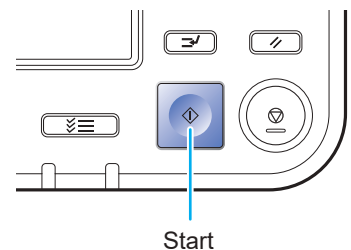



What is the [Favorites] Function?

The details configured in the [Copy] screen and the [Scan] screen can be registered as [Favorites]. If you register the settings you frequently use, you can eliminate the need to configure the same settings each time. Add shortcuts of registered [Favorites] to the [Home2] screen to bring these up at any time.

Registering the current settings for future use

1 Touch [Custom Menu].

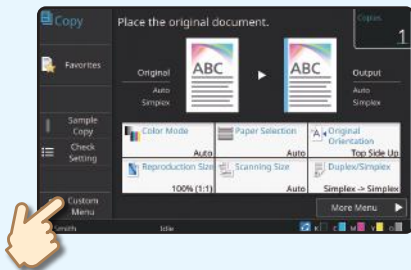

2 Touch [Create].

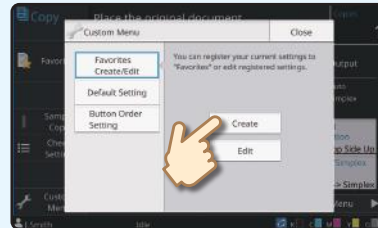

Perform registration by following the instructions provided on the screen.

Creating a shortcut of [Favorites]

Shortcuts of [Favorites] can be created on the [Home2] screen.

1 Touch [Add] on the [Home2] screen.

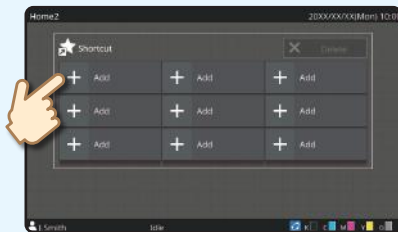

2 Pick a favorite from the list and touch [OK].

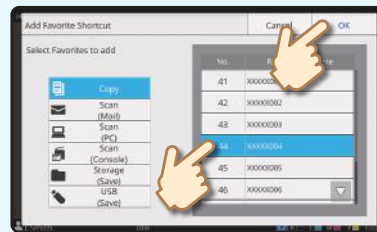

Once a shortcut has been created

Touch the registered shortcut to bring up the settings registered with the favorites.

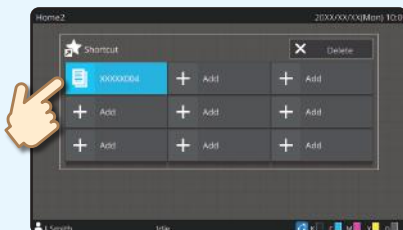

Press the [Start] key to start copying or scanning with the settings that have been loaded.

Printing

In this section, the procedure for printing from the Microsoft® Windows® 10 Notepad application is described as an example.

Sending Data to This Machine

1. Click [Print...] in the [File] menu.

 The menu and button names are different depending on the application that you use.

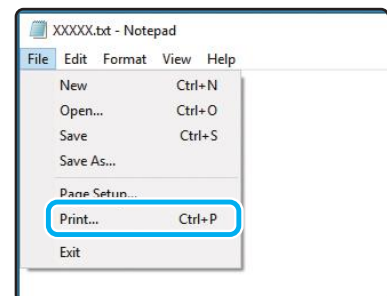

2. Click [Preferences], and check the settings.

After confirming the settings, click [OK] and close the printer driver screen.

About the Various Printing Functions ▶▶ p.20

 Registering frequently used settings can be useful. You can call up the specified values* just by clicking [Restore user settings]. For more information, see the "User's Guide".

* The specified value is indicated as a value that has been changed from [Printer properties].

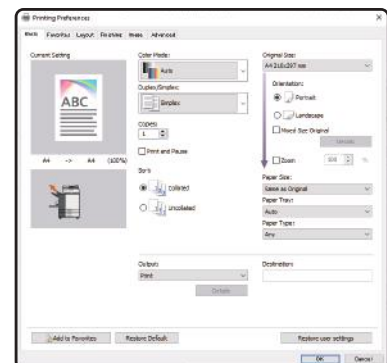

3. Click [Print].

The print data is sent to this machine.

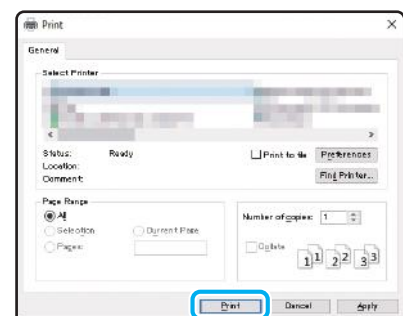

At the factory settings, the machine starts printing automatically when you log in.
 If printing does not start automatically when you log in, perform the procedure below.

Printing From This Machine

1. Touch [Print] on the [Home1] screen.



2. Select the job.

You can touch [Thumbnail] to view the waiting jobs as thumbnails.

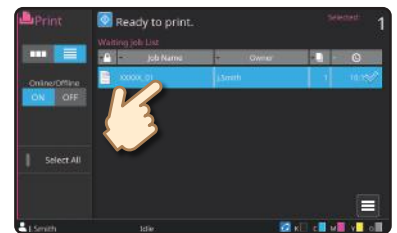

3. Press the [Start] key.

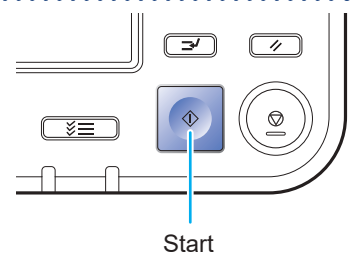

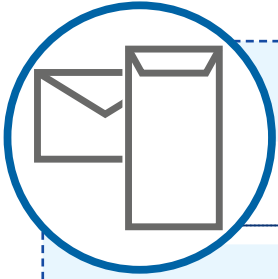

How to Print on Envelopes?

The following describes how to print on No.10 Envelope size envelopes as an example. The document data used here is set to the same size as the envelope and its orientation is set to Portrait.

When printing on envelopes, it is recommended that you connect the optional stacking tray and envelope feeder.

Loading the Envelope

Slide the guides and load the envelope.

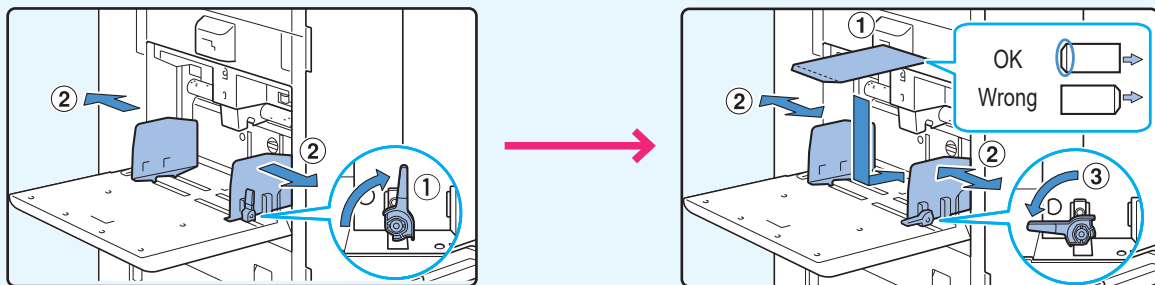

- Load the envelope so that the bottom edge (without the flap) enters the machine first.
- Set the paper feed pressure adjustment lever to "≠(CARD)" depending on the thickness (paper weight) of the envelope. For more information, see the "User's Guide".

Specifying the Paper Size for the Standard Tray Using the Operation Panel

Touch [Home1] screen - [System Info] - [Paper Tray Setting] - [Std Tray].

Consumables ►► p.33

1 Touch [OFF] in [Double-feed Check].

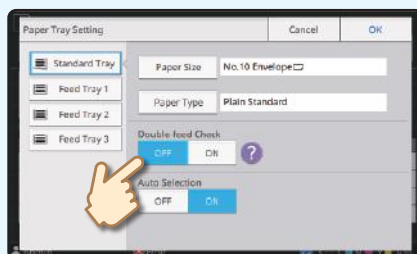

2 Confirm the envelope size in [Paper Size].

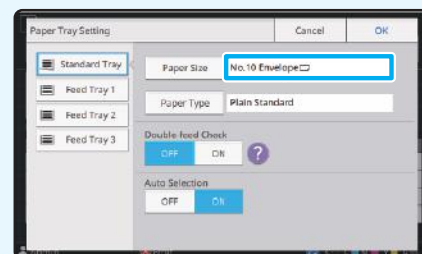

The paper size is set automatically when [Paper Size] is set to [Auto] and an envelope of a size that the machine can detect is loaded in the standard tray. To change the setting, touch [Paper Size] - [Standard], select the envelope size, and then touch [OK].

 If you load an envelope the paper size of which cannot be selected from [Standard], register your envelope size in [Custom Paper Entry] on the administrator menu.

3 Touch [Paper Type].

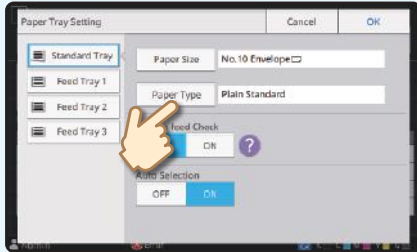

Touch [OK] to finish the setting.

-  • [Type]: Touch [Plain] or [IJ Paper].
- [Thickness]: Touch [Envelope]*.

* [Envelope] is selected automatically when you perform either of the following with the standard tray:

- Loading an envelope of a size that the machine can detect in the standard tray when [Paper Size] is set to [Auto]
- Selecting an envelope size in [Standard] of [Paper Size]

Configuring Settings Using the Printer Driver

Configure the settings in the [Basic] tab.

1 Select the No.10 Envelope for [Original Size] and select [Portrait] for [Orientation].

2 Select [Same as Original] for [Paper Size].

3 Select [Standard Tray] for [Paper Tray].

 Specify the output tray in [Output Tray] in the [Finishing] tab.

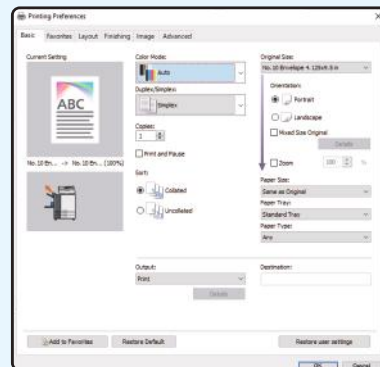

Configure the settings in the [Layout] tab.

4 Select [180 deg] for [Rotation].
The print orientation is rotated 180 degrees.

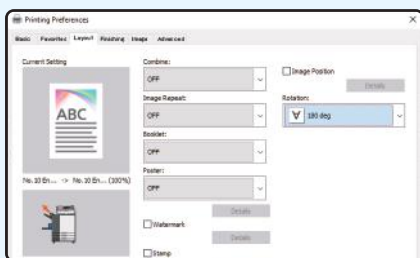

Click [OK] to finish the setting.

Finally Completed Image

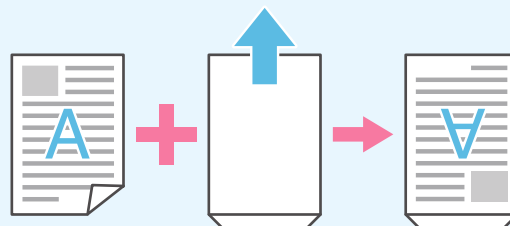

About the Various Printing Functions

Print and Pause

Print one sample before printing a large number of pages. This enables you to check the results and settings.



Paper Type

Print using the optimal colors for the type of paper that is selected.

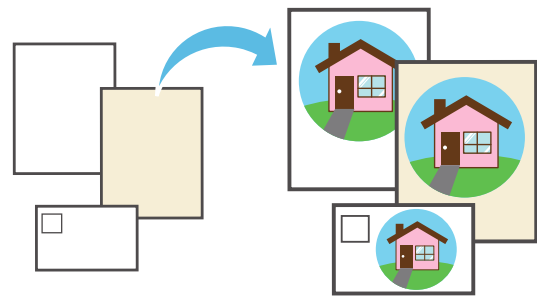

Storage

Save documents in a folder on the machine. You can print the data when needed.

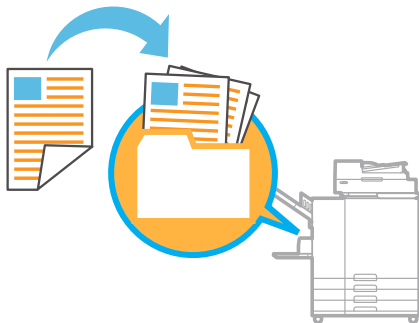

Combine

Print continuous pages together on one sheet. You can use this setting to save paper.

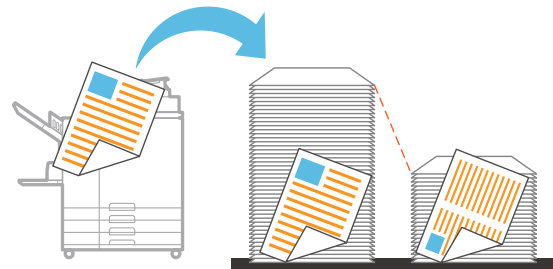

Booklet

Print reordering the pages to be in the correct order when folded in half.



Binding Edge

Configure the position at which the paper will be bound. The binding margin can also be adjusted.



Processing Speed Priority

The printout is made at 300 x 300 dpi resolution without using gray ink. This option reduces the image processing load.

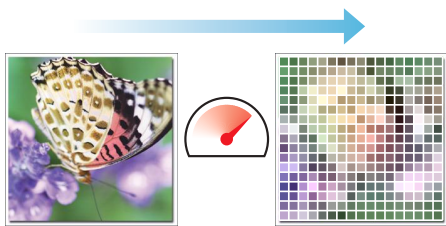

Screening

Configure whether to express continuous gradations with the density of dots or with the size of dots.

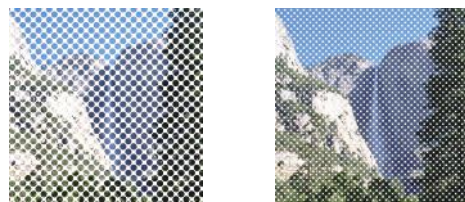

Envelope Imaging

Minimize blurring and smudging when printing on envelopes.

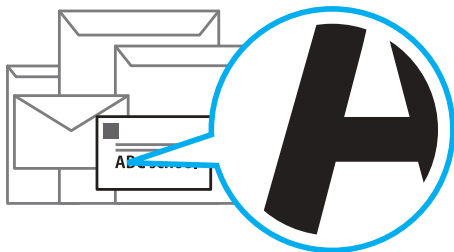

Program

Print according to a preconfigured program for the number of copies or number of sets. The slip sheet function can also be configured.

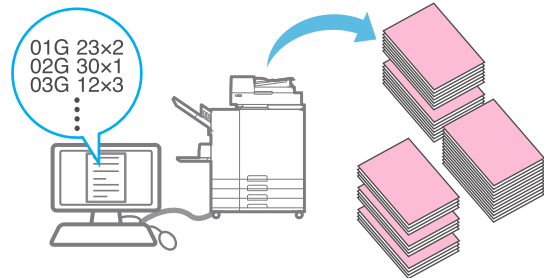

Poster Printing

Enlarge one page of image data and divide it onto multiple sheets of paper for printing.

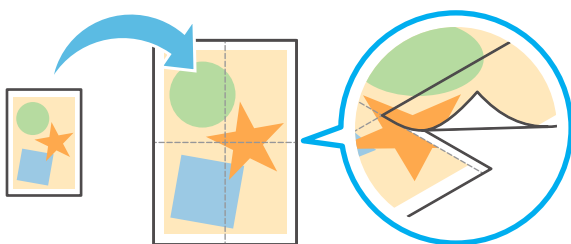

Blank Page Detection

Specify this to prevent blank pages of the original from being printed.

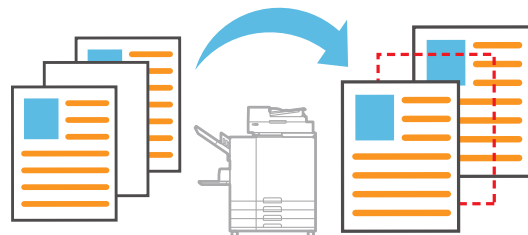

Using Storage

The scanned data is saved along with the print settings.

Saving Scanned Data to Storage

1. Load the original.

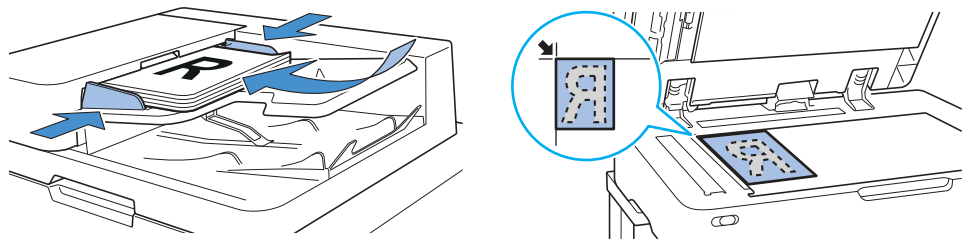

2. Touch [Storage] - [Save] on the [Home1] screen.

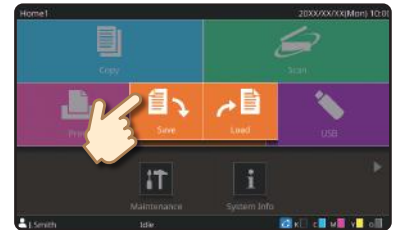

3. Select the destination folder and touch [Save Document].

You can change the settings.

You can touch [Add Folder] to create a new folder to use as the destination.

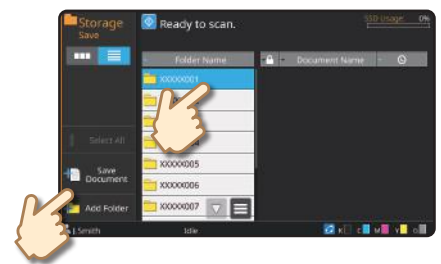

4. Press the [Start] key.

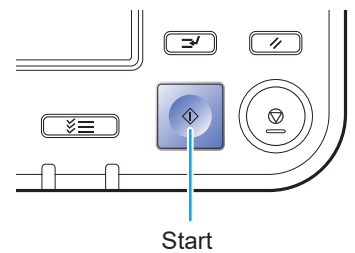

The data is printed with the settings saved along with the data.

Printing Saved Data from Storage

1. Touch [Storage] - [Load] on the [Home1] screen.



2. Select the folder that you want to load, and select the document.

-  You can touch [Search] to search for documents.
Enter the number of copies using the numeric keys.

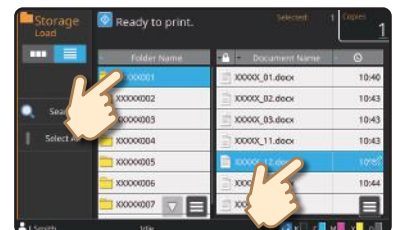

3. Press the [Start] key.

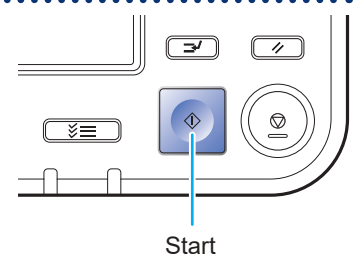

Using a USB Flash Drive

Scanned data will be saved in one of the following file formats: PDF, TIFF, or JPEG

Saving Scanned Data to a USB Flash Drive

1. Load the original and connect a USB flash drive to the machine.

 You can use a USB flash drive compatible with Mass Storage Class and file system format (FAT16, FAT32, exFAT).

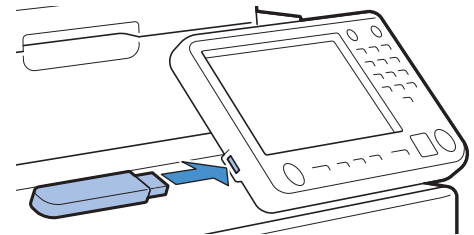

2. Touch [USB] - [Save] on the [Home1] screen.

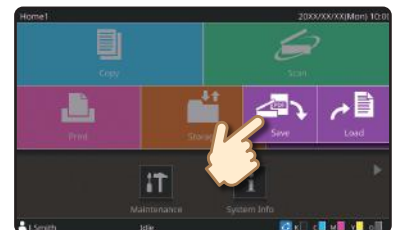

3. Select the destination folder and touch [Save Document].

You can change the settings.

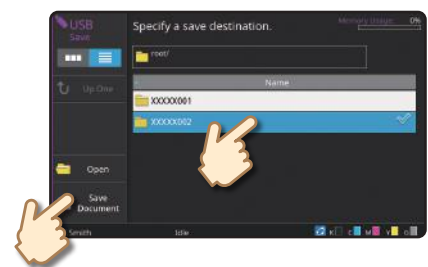

4. Press the [Start] key.

The data is saved to the USB flash drive.

 Do not remove the USB flash drive until saving is finished.

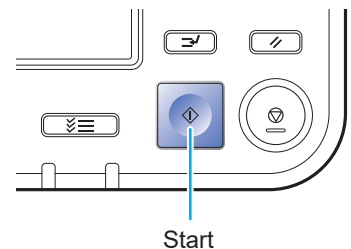

Print PRN files saved to a USB flash drive from the printer driver.

Printing Data from a USB Flash Drive

1. Connect a USB flash drive to your computer.

- Only PRN-format files saved from the printer driver of the machine to the USB flash drive can be printed.
- If you are using the optional PS kit, you can also use PDF files. For more information, see the "User's Guide".

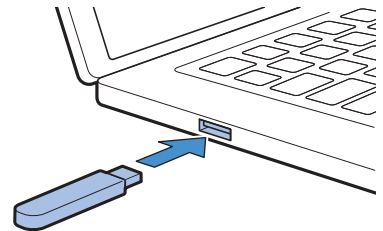

2. Select the print option from the application.

Open the file that you want to save to the USB flash drive from the application.

3. Check the printer name and click [Properties].



4. Select [Save to USB Drive] for [Output].

- Configure the settings in [Basic] tab on the printer driver screen.
- Touch [Details] to select the destination folder in the USB flash drive.

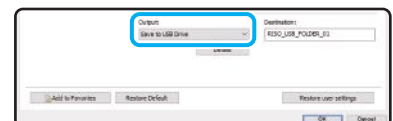

➔ Continued on next page

Using a USB Flash Drive (Continued)

5. Change the other items as needed.

6. Click [OK].

-  If the USB flash drive does not have the RISO folder structure, a message asking you to create a new folder is displayed. Click [OK] to create a folder required for printing on the USB flash drive. When the folder is already created, the message is not displayed.

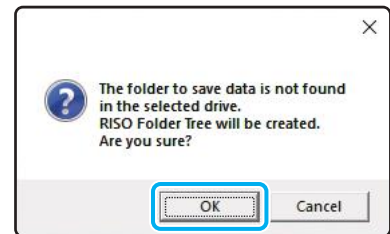

7. Click [Print] in the print dialog box.

-  Do not remove the USB flash drive until saving is finished. During data saving, a printer icon appears in the taskbar shown on the computer. When saving is completed, the printer icon disappears. Make sure that the icon has disappeared.

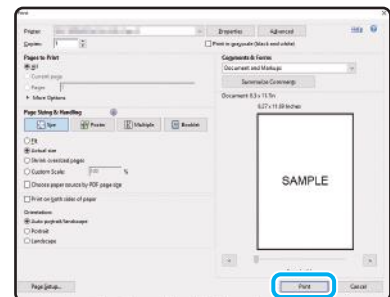

8. Remove the USB flash drive.

-  Make sure that a PRN file has been generated in the specified folder on the USB flash drive, and then remove the USB flash drive.

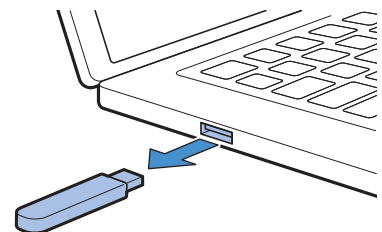

9. Connect a USB flash drive to the machine.

 PRN files saved to the USB flash drive from the printer driver can be printed.

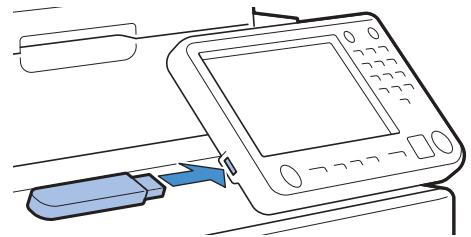

10. Touch [USB] - [Load] on the [Home1] screen.

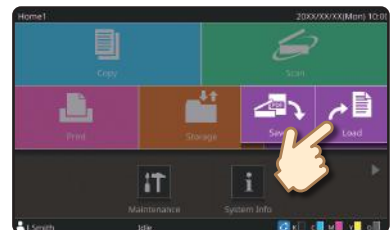

11. Open the folder that you want to load, and select the document.

Enter the number of copies using the numeric keys.

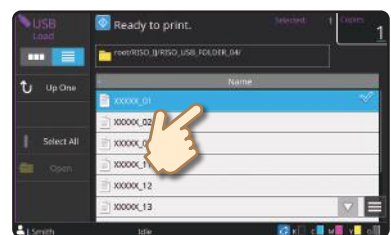

12. Press the [Start] key.

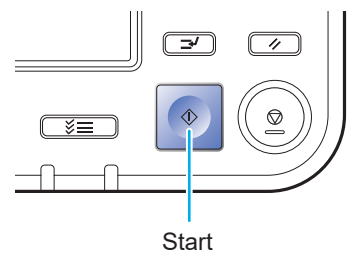

When Paper Runs Out

We recommend loading plain paper in the feed trays.

Loading Paper in the Feed Tray

1

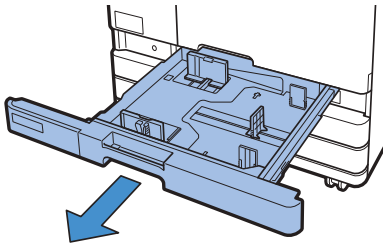

2

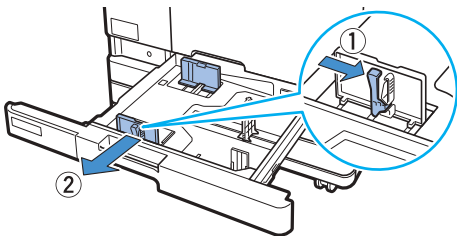

3

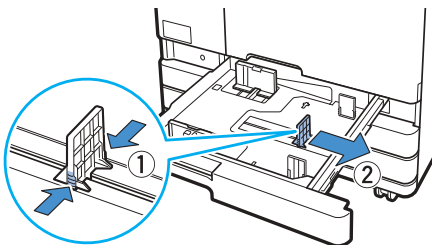

4

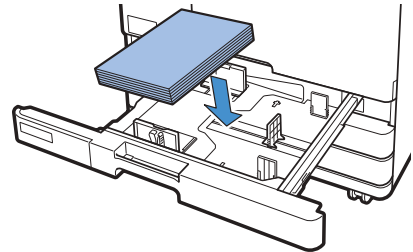

When using A4 paper

5

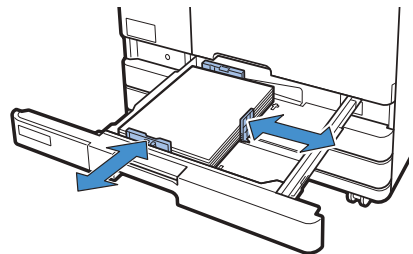

! The machine detects the size of the paper based on the stopper position. Make sure to position the stopper against the edge of the paper.

6

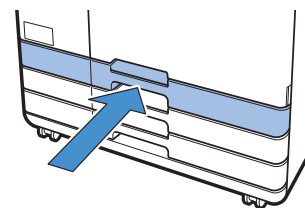

! When you have switched to a different type or size of paper, update the feed tray settings from [Home1] screen - [System Info] - [Paper Tray Setting].

Load the standard tray with special paper such as thick paper, postcards, or envelopes.

Loading Paper in the Standard Tray

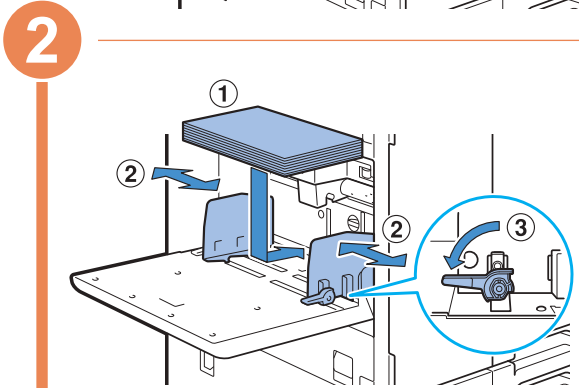
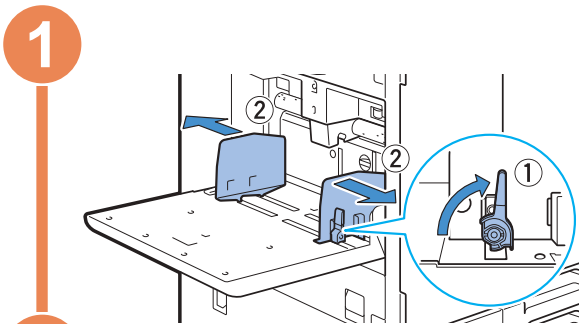

! The machine detects the paper size based on the guide position. Make sure to position the guides against the edges of the paper.

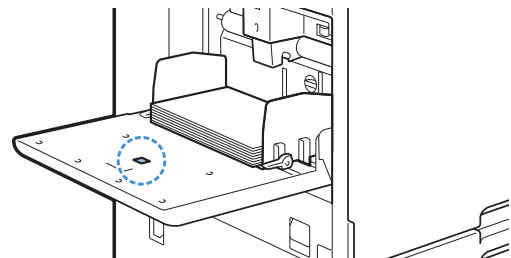

- !** Do not place spare paper on the paper size detection sensor when loading A4 or A5 size paper. If the sensor is blocked, the machine cannot detect the paper size correctly.
- When you have switched to a different type or size of paper, update the standard tray settings from [Home1] screen - [System Info] - [Paper Tray Setting].

Do Not Use These Paper Types

Using these paper types may cause problems such as paper jams.

- Paper that does not comply with the conditions in the basic specifications*
- Paper with a processed surface, such as thermal paper or carbon paper
- Curled paper (3 mm (1/8") or more)
- Paper with wrinkles
- Bent paper
- Torn paper
- Paper with ripples
- Coated paper such as art paper
- Paper with jagged edges
- Glued paper
- Paper with holes
- Gloss paper for photographs
- Transparencies
- Synthesized paper (Yupo)

* For more information on basic specifications, see the "User's Guide".

When Ink Runs Out

When ink runs out, the ink replacement message is displayed and printing stops. You cannot print if the message shows that even one color needs to be replaced.

Replacing the Ink Cartridge

1

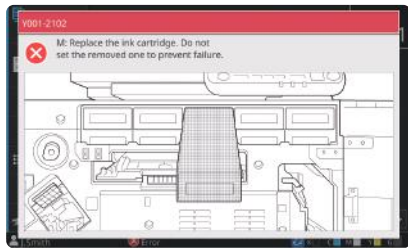

Replace the cartridge of the color shown.

2

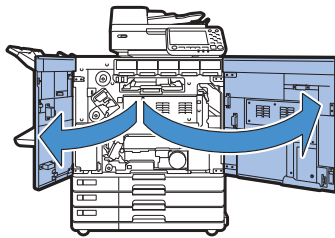

3

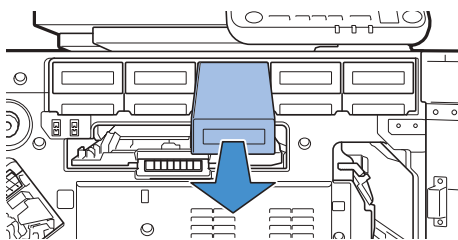

4

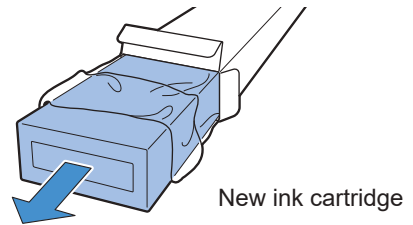

5

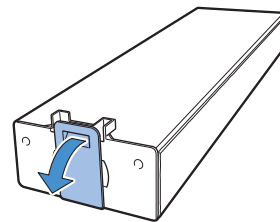

6

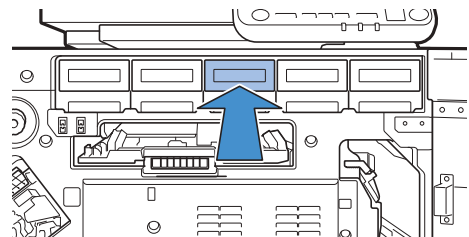

7

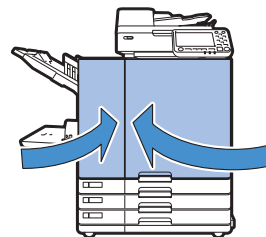

Handling the Ink Cartridge

Pay attention to the following when handling the ink cartridge.

CAUTION

- Avoid getting ink on your skin or in your eyes.
 - Ensure adequate ventilation during printing.
 - If you start to feel ill when using the machine, consult a physician immediately.
-  • We recommend using genuine RISO ink.
- Using ink other than RISO ink may prevent optimal printer performance. Malfunctions and reduced performance resulting from the use of non-RISO ink are not covered by the product warranty or service contract.
 - Use the ink cartridge within approximately 24 months from the date of manufacture (when preserved under room temperature). To maintain good printing quality, check the manufacture date and use soon after purchase.
You can find the date of manufacture on the ink cartridge.
 - In order to maintain optimal printing quality, take note of the date of manufacture and consume as soon as possible after purchase.
 - Do not remove the ink cartridge until the ink replacement message is displayed.
 - Do not shake the ink cartridge. Shaking will create air bubbles, which may prevent the ink from discharging properly and result in blurred printing.
 - The ink cartridge is made from paper and plastic. Do not drop or damage it.
 - Remove the ink cartridge from its plastic bag immediately before inserting it into the machine.
 - Do not remove the ink cartridge cap until immediately before using the cartridge.
 - After removing the ink cartridge cap, keep the ink supply outlet facing up. If the outlet faces down, ink may leak out.
 - There may be ink on the area where you removed the protective cap. Do not touch it.
Ink coming in contact with clothes will result in permanent stains.
 - Do not attempt to refill the ink cartridge.

For additional precautions related to the ink cartridges, also see the "User's Guide".

Scanner Care

Periodically clean the scanner to ensure optimal image quality for copies and scans.

Foreign matter such as dust, dirt, ink, glue or correction fluid on the platen glass or white sheet of the ADF may reduce the quality of copies or scans. Gently wipe the areas indicated below several times with a soft cloth.

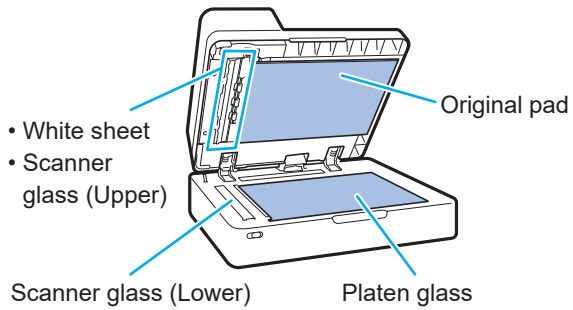

- ❗ Do not perform operations other than those described in this guide. To adjust or repair this machine, make sure to contact your dealer or authorized service representative.
- The platen glass is fragile. Never touch it with hard objects or expose it to impact.

Scanner Glass

If the scanner glass is dirty, black streaks may appear on copies and scans.

Wipe the scanner glass with a soft cloth. Follow the procedure below when wiping the scanner glass on the top part of the scanner.

1

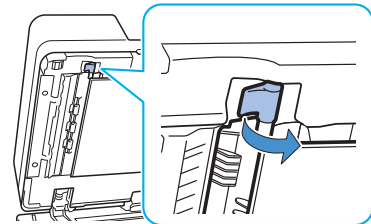

2

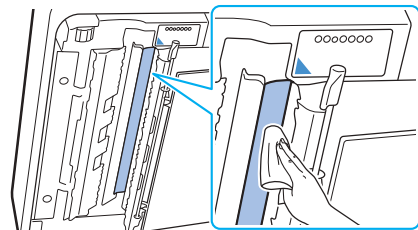

3

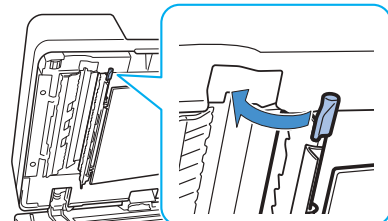



Useful Tips

Consumables

By touching [System Info] on the [Home1] screen, you can check the status of consumables such as remaining ink and the amount of paper left in the standard tray and paper tray.



RISO Console

The RISO Console provides remote access to the machine via your computer's web browser, enabling you to check the machine's status and settings, as well as handle data, from a different location.

You can also check the status of consumables such as the ink and paper.

To use the RISO Console, make sure the machine has been connected to the network.

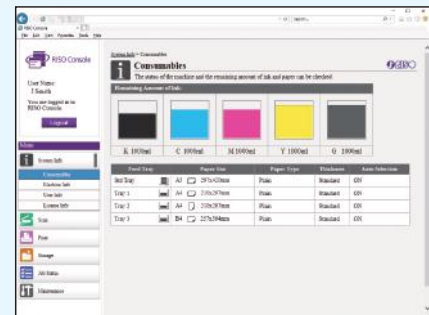

Cleaning the Print Head

The printed paper may have white streaks or appear blurry due to the clogged print head. Touch [Maintenance] – [Print Head Cleaning] on the [Home1] screen to unclog the print head. Normally, set [Normal Cleaning]. If this does not fix the problem, perform [Strong Cleaning].



Printer Configuration

When adding optional equipment to the machine, configure the printer configuration in the [Environment] tab of the printer. Click [Get Printer Info] to obtain the optional equipment configuration information from the printer.

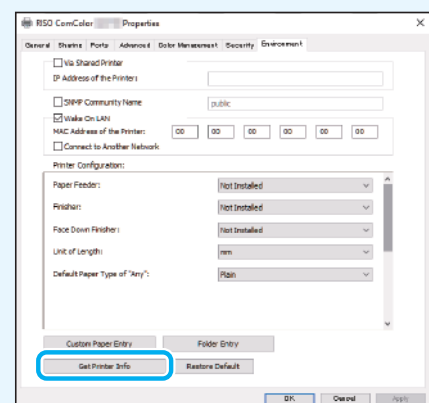

What You Can Do With This Machine

This section describes some printouts that you can create with the machine.

• Examples of Use Patterns and Printouts

For more information on how to print, see the "User's Guide".

Normal Printing

You can print with the machine for various purposes.

Signboard

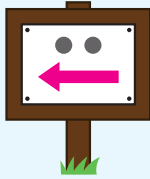

Sign (such as a garland sign)



Notice heading



Leaflet

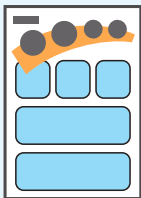

Study note



Weekly schedule

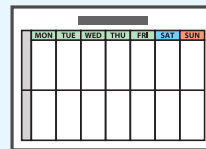

Attendance card

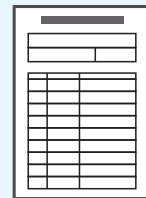

DM



Catalog

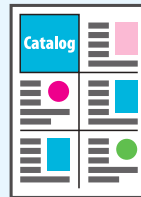

Letter of acknowledgement



Notice frame



News



Teaching material

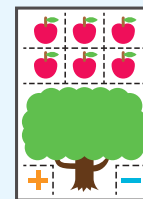

Poster Printing

You can create a large printout by using the poster function.

Poster

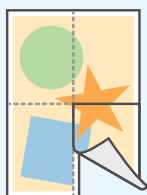

Envelop Printing (Envelope Imaging)

You can directly print on envelopes.

Envelope



Transactional Printing

The data which varies every time when it is output (variable data) can also be printed at a high speed.

Transaction form

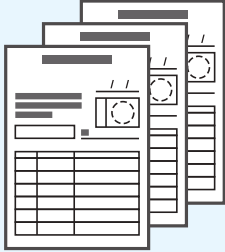

Transaction form with a payment sheet



Printouts Made With Optional Equipment

If optional equipment is connected with the machine, you can also use additional functions.

Staple

Either the face down finisher or multifunction finisher is required.

Booklet with saddle stitch stapling

The multifunction finisher is required.

Reference materials

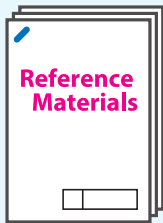

Exam questions

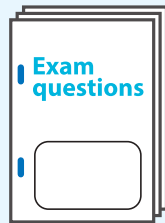

Report



Tri-fold

The multifunction finisher with the folder unit installed is required.

Bi-fold

The multifunction finisher is required.

Punch

The multifunction finisher with the punch unit installed is required.

Booklet



Program



Works

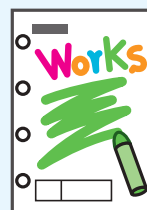

Books (quotation, invoice)

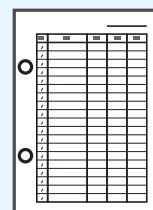



Storing Consumables

• Paper Storage and Handling

- Always use paper from a sealed package.
- After you finish printing, remove the unused paper from the standard tray, place it back in the original package, and store it until you need it again. If you leave the paper in the standard tray, the paper may curl, causing a paper jam.

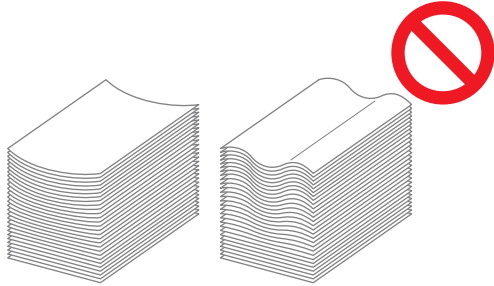

- If the paper is not cut very well or if the paper has a textured surface (such as drawing paper), fan the paper before use.
- Store the paper flat in a location that is not hot, humid, or exposed to direct sunlight.

• Storing Ink Cartridges

Because the ink cartridges are partially made of paper, they may become deformed and unusable if stored incorrectly or in an unsuitable environment. Store the ink cartridges correctly following the guidelines below.

- Store the ink cartridges in their original package, and make sure to keep them level with the "this side up" mark oriented properly.
- Avoid freezing and direct sunlight. Store in a location with a temperature between 5°C and 35°C (41°F and 95°F). Do not store in a location subject to extreme changes in temperature.
- When storing ink after removing it from the plastic bag, keep it in the orientation indicated on the cartridge and load it in the machine promptly.



Originals That May Not Be Copied

- **Do not use the equipment in any manner that violates the law or infringes on established copyrights, even when making copies for personal use. Consult your dealer or authorized service representative for further details. In general, use discretion and common sense.**

- **Do not use the machine to make copies of the following items.**

- Copies of business-related documents, such as publicly issued stock certificates, drafts, and checks, other than copies required for business use
- Copies of government-issued passports; motor vehicle licenses, permits, and personal identification documents issued by public or private organizations; and pass tickets, food tickets, and other tickets
- Copies of copyrighted items, such as publications, music, works of art, prints, drawings, and photographs, other than for personal or household use

Trademark Credits

Microsoft, Windows, Windows Server, Internet Explorer, and Microsoft Edge are either registered trademarks or trademarks of Microsoft Corporation in the United States and/or other countries.

Mac, macOS, OS X, and Safari are trademarks of Apple Inc.

Adobe, the Adobe logo, PostScript, and PostScript 3 are either registered trademarks or trademarks of Adobe in the United States and/or other countries.

Linux® is the registered trademark of Linus Torvalds in the U.S. and other countries.

ColorSet is a trademark of Monotype Imaging Inc. registered in the U.S. Patent & Trademark Office and may be registered in certain jurisdictions.

FeliCa is a registered trademark of Sony Corporation.

MIFARE is a registered trademark of NXP B.V.

 RISO, ComColor and FORCEJET are trademarks or registered trademarks of RISO KAGAKU CORPORATION in the United States and other countries.

Other corporate names and/or trademarks are either registered trademarks or trademarks of each company, respectively.



In the United States, Canada, and Taiwan

As an ENERGY STAR® Partner, RISO KAGAKU CORPORATION has determined that this product meets the ENERGY STAR® guidelines for energy efficiency.



Please contact the following for supplies and service: