



# *Speed Forward*

A new standard of performance that exceeds your expectations

Digital duplicator

# RISO

# SF9450

Ledger/150 ppm/600 × 600 dpi/Full-color LCD touch panel/  
Versatile connectivity

## **Introducing the SF series, the all-new global brand that meets all kinds of user needs**

Employed in over 180 countries and regions, RISO has been successfully meeting all user needs by constantly listening to the feedback from our customers in order to continually improve our products. The SF series is an important milestone and a masterpiece of our ceaseless innovation. With the fastest speed in its class plus the superior operability and print quality, the SF series ushers you into a higher dimension of printing.





*High Productivity*  
**150** ppm *High-speed printing*



*Simple Operation*  
**New control panel design**

*High Definition*  
**600 x 600** dpi *High-resolution*



**RISO SF 9450**

“Since print volume is normally very large, time and costs are major concerns.”



## RISO offers outstanding productivity through high speed and low cost.

### High-speed 150 ppm printing

Achieving 1000 pages printed in approx. 7 minutes, this is the world’s fastest printing speed in this range. This surprisingly rapid rate will efficiently support your heavy paperwork requirements.



### Quick Master Making mode **NEW**

A new function, speed priority mode, shortens the master-making time while still maintaining high image quality.

### Heavy-load paper feeding

The paper trays have a capacity of 1000 sheets\* for both feeding and receiving, which ensures uninterrupted printing over a longer period.



\*When using the following weight of paper: 17-lb bond to 21lb-bond

### Overwhelmingly economical print costs

The SF series makes prints from a master. As a result, the more pages generated from each master the lower the cost per print, making it highly economical for medium- to high-volume printing.

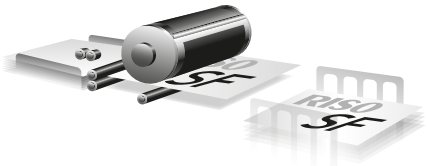

Print quantity and cost per print

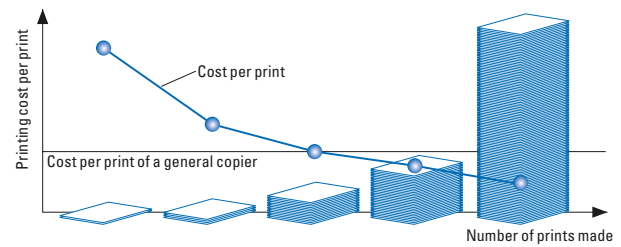

### Paper saving

Page layout printing combines multiple copies of the same page, or copies of multiple pages onto a single printed page to save paper. Conveniently condense bulky multiple-page documents in an easy-to-read format. These functions are available when using the printer driver.

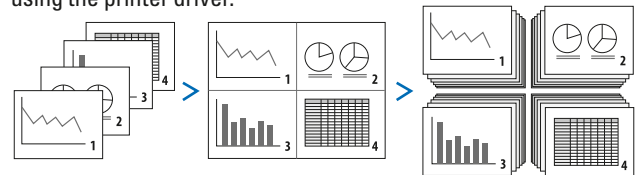

### Versatile paper handling capability

The SF series plays multiple roles, accepting a wide range of paper types such as recycled paper, coarse paper, cards and envelopes.

### Easily adjustable receiving tray **Improved**

The receiving tray can be adjusted easily with a click feeling for each standard paper size. Improved design allows printed papers to settle in an orderly way for smooth pickup.



“Aren’t digital printers difficult to operate?”

No need to worry.  
Operation is easy for everyone.



**Redesigned control panel** Improved

New, easy-to-use control panel provides intuitive operation.

**7-inch color touch panel display** NEW

Functions for printing, copying, scanning and managing data are all at your fingertips, logically arranged for intuitive operation on a large 7-inch color LCD touch screen.

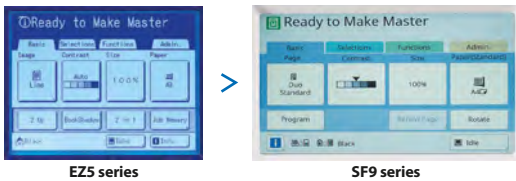

**RISO console** NEW

The total management system improves convenience by integrating applications in one place. Product, consumables and system information can all be checked easily on your PC.

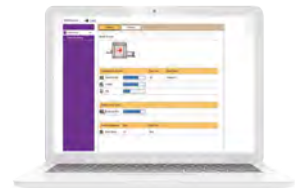

**Versatile program print**

For example, you can print question papers for three different classes, A, B and C, that contain different numbers of students. Simply set up the program, place the three original tests in the Auto Document Feeder and press “print” — you’ll automatically receive the required numbers of each individual test.

**Various printing approaches**

The SF series offers various ways of printing, depending on your specific requirements.

- Standard equipment of PC-I/F
- Direct printing from a USB flash drive
- General SD card compatible for data storage Improved

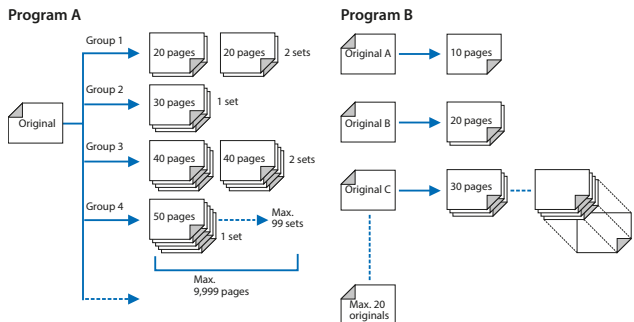

“We don’t want to compromise the beauty of the finish.”



## Images and text can be printed with outstanding quality.

### High image quality 600 × 600 dpi printing **Improved**

Improved resolution for both scanning and printing. This achieves sharp and clear output with the highest image quality.

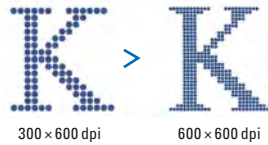

### Enhanced features for clearer output

#### High scanning quality **NEW**

The newly designed scanner attains smooth tonal gradation even with photo images.

- Reduced blown-out highlights via equalized dot description

#### Improved image-processing function **Improved**

Decreases image deterioration through improved image processing, delivering clearer output.

- Minimizes blocked-up shadows through enhanced gamma correction
- Sharp outlines with contour enhancement achieved

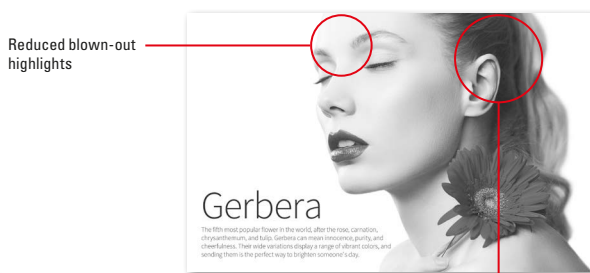

Minimizes blocked-up shadows

### Ink color variations

21 standard colors plus 50 custom colors are available. A wide range of printing colors can meet the needs of a variety of print jobs.

Red	Bright Red	RISO-Marine Red	Burgundy	Brown	Yellow	Green
Teal	Blue	Medium Blue	RISO-Fed. Blue	Purple	Flat Gold	Orange
Crimson	Hunter Green	Gray	Light Gray	Fluorescent Pink	Fluores. Orange	Gold

[Custom colors]

### Other various functions for optimum output

- Auto base control
- Tone smooth function
- Four image-processing modes: Line, Photo, Duo, and Pencil

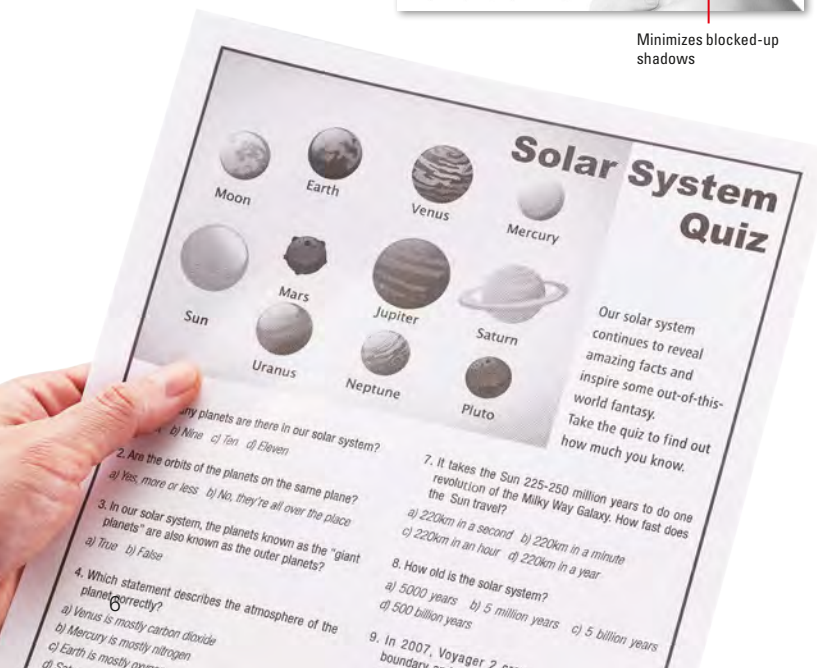

“How can we manage the information and consumables.”

## We support information and consumables management.



### IC card security

Enhanced security by an optional IC card activation kit. Only an authorized user can perform printing, effective to prevent divulging information from secret documents.



### Usage report

The SF series provides RISO Copy Count Viewer for counting users' printouts, useful for understanding expenses and usage restriction. The aggregate results are available via printout, USB flash drive or email.

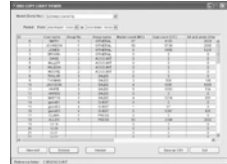

“Ecology is an important concern to us all.”

## We strongly care about global environmental issues as well.



### Eco-friendly

The SF series consumes 1/10th the energy, compared with energy star guidelines.

- ENERGY STAR® qualified and RoHS certified
- Complies with the ErP directive in Europe
- Consumes less power and produces less heat
- Energy-saving system



### Rice bran oil ink **NEW**

The rice bran oil ink contributes to environment sustainability. Rice bran, which would be otherwise wasted, is a raw material with no VOCs, so after the oil is extracted for the ink. It can subsequently be used as fertilizer or animal feed.

### Dimensions

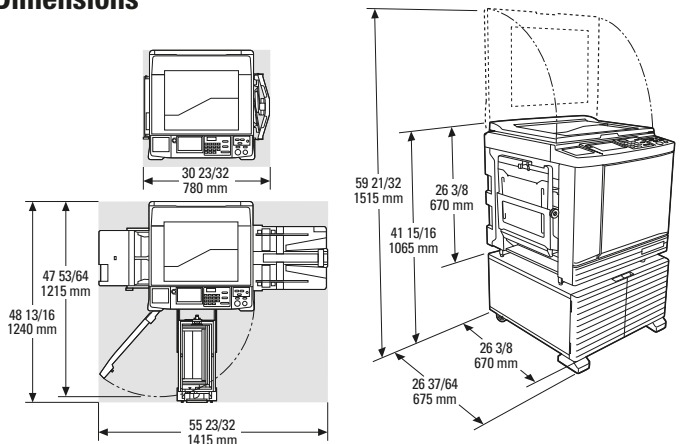

## Optional Accessories

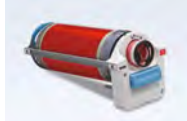

RISO SF Drum



RISO Auto Document Feeder VII



Job Separator IV; NIII



Card Feed Kit



RISO Key Card Counter IV; N



RISO Controller IS300



RISO Stand D Type III  
Deluxe and with doors for convenient storage with a neat appearance.



RISO Stand N Type III  
Sturdy open-front stand also offers convenient storage of consumables.

- IC Card Reader Activation Kit RG
- Wide Stacking Tray  
Allows use of paper up to 555 mm in long edge.
- RISO Printer driver for Macintosh

## Specifications

<b>Master Making/Printing Methods</b>		High-speed digital master-making/Fully automatic printing
<b>Original Type</b>		Book or sheet
<b>Master Making Time*1</b>	<b>Quick Master Making mode</b>	- Approx. 15 seconds (Letter, long-edge feed) - Approx. 17 seconds (Letter, short-edge feed)
	<b>Normal master making mode</b>	- Approx. 17 seconds (Letter, long-edge feed) - Approx. 19 seconds (Letter, short-edge feed)
<b>Resolution</b>	<b>Scanning</b>	600 dpi × 600 dpi
	<b>Printing</b>	600 dpi × 600 dpi, Quick Master Making mode: 600 dpi × 400 dpi
<b>Maximum Scanning Area</b>		11 11/16 inches × 17 inches (297 mm × 432 mm)
<b>Print Paper Weight</b>		12-lb bond to 116-lb index (46 gsm to 210 gsm)
<b>Print Paper Size*2</b>		3 15/16 inches × 5 13/16 inches to 12 7/32 inches × 17 inches (100 mm × 148 mm to 310 mm × 432 mm)
<b>Maximum Printing Area</b>		11 15/32 inches × 16 23/32 inches (291 mm × 425 mm)
<b>Paper Feed Tray Stacking Capacity</b>		1000 sheets*3, stacking height of 4 11/32 inches (110 mm) or lower
<b>Paper Receiving Tray Stacking Capacity</b>		1000 sheets*3, stacking height of 4 11/32 inches (110 mm) or lower
<b>Print Speed</b>		6 levels: 60, 80, 100, 120, 130, and 150 ppm*4
<b>Print Position Adjustment</b>		Horizontal: ±19/32 inches, Vertical: ±13/32 inches (Horizontal: ±15 mm, Vertical: ±10 mm)
<b>Image Processing Mode</b>		Line, Photo (Standard/Portrait), Duo (Standard/Line/Photo), Pencil (Darker/Lighter)
<b>Print Reproduction Ratio</b>		Type: inch Zoom (50% to 200%), Free, 100% reduction ratio, Margin+ (90% to 99%), 4 levels of enlargement (200%, 154%, 129%, 121%), 4 levels of reduction (78%, 65%, 61%, 50%) Type: mm Zoom (50% to 200%), Free, 100% reduction ratio, Margin+ (90% to 99%), 4 levels of enlargement (163%, 141%, 122%, 116%), 4 levels of reduction (87%, 82%, 71%, 61%)
<b>User Interface</b>		Color touch panel
<b>Functions</b>		Image, Contrast, Size, Paper Size Detection, Dot Process, Contrast Adj., Tone Curve, Multi-up Print, Book Shadow, Top Margin Adj., Binding Margin Adj., Max. Scan, Ink Saving, Quick Master Making, Preview, ADF-Semi-Auto*5, Storage, Overlay, Print Speed Adj., Print Density Adj., Print Position Adj., Interval, Renew Page, Auto Page Renewal, Rotate, Special Paper Ctrl, Program, Job Separation*5, Job Memory, Reservation, Editor, Idling Action, Confidential, My Direct Access, Meter Display, ID Counter Report, Proof Copy, Direct Printing, USB Job List, Scanning mode, Admin., Auto Sleep, Auto Power-OFF, Power-OFF Schedule, ECO mode, Protect, RISO iQuality System
<b>Ink Supply</b>		Full automatic (1000 ml/cartridge)
<b>Master Supply/Disposal</b>		Full automatic (Ledger: approx. 215 sheets per roll)/Disposal capacity: approx. 100 sheets
<b>Power Source</b>		AC 100-240 V, 50-60 Hz <3.4-1.6 A>
<b>Power Consumption</b>	<b>Standard</b>	Max.: 300 W, Ready: 20 W or lower, Sleep: 5 W or lower, Power-OFF: 0.5 W or lower
	<b>Optional Accessories Connected*6</b>	Max.: 315 W, Ready: 30 W or lower, Sleep: 10 W or lower, Power-OFF: 0.5 W or lower
<b>Dimensions (W×D×H)</b>	<b>In use</b>	55 23/32 inches × 26 3/8 inches*7 × 41 15/16 inches*8 (1415 mm × 670 mm*7 × 1065 mm*8)
	<b>In storage</b>	30 23/32 inches × 26 3/8 inches*7 × 41 15/16 inches*8 (780 mm × 670 mm*7 × 1065 mm*8)
<b>Required Space (W×D×H)</b>		55 23/32 inches × 48 13/16 inches × 59 21/32 inches*8 (1415 mm × 1240 mm × 1515 mm*8)
<b>Weight</b>		225 lb (102 kg)*9
<b>Safety Information</b>		IEC-60950-1 compliant, indoor, pollution degree 2*10, at altitudes of 2000 m or lower

\*1 Measurement value when set to 100% reproduction ratio.

\*2 When the optional Wide Stacking Tray is installed, you can use paper up to a size of 12 7/32 inches × 21 27/32 inches (310 mm × 555 mm) by setting [Custom Paper Entry].

\*3 When using the following weight of paper: 17-lb bond to 21-lb bond (64 gsm to 80 gsm)

\*4 If the temperature of the inside of the print drum (cylinder) is less than 59°F (15°C), [150 ppm] is not usable.

\*5 Optional accessories required.

\*6 When all the following optional accessories are installed, Auto Document Feeder, Job Separator, Key/Card Counter.

\*7 The depth does not include the stabilizers for the stand.

\*8 The height includes the stand.

\*9 The weight does not include the ink, master roll, and stand.

\*10 The pollution degree of the usage environment due to dirt and dust in the air. Degree "2" corresponds to a general indoor environment.

Notes: The specifications are subject to change without prior notice.

and RISO are trademarks or registered trademarks of RISO KAGAKU CORPORATION in the United States and other countries.

RISO iQualitySystem™ and i are the trademarks of RISO KAGAKU CORPORATION.

Other corporate names and/or trademarks are either registered trademarks or trademarks of each company, respectively.

Copyright ©2016 RISO KAGAKU CORPORATION. All rights reserved.



RISO, Inc.  
800 District Ave, Suite 390 Burlington, MA 01803  
<http://us.riso.com/>

For more details please contact: