

# RISO *SE* Series

## *User's Guide*

**9480/9380**

RISO *SE* Series

*User's Guide*

9480/9380



Please contact following for supplies and service:





As an **ENERGY STAR**® Partner, RISO KAGAKU CORP. has determined that this product meets the **ENERGY STAR**® guidelines for energy efficiency.

**For SE9480U Model Only**

**Duplicator**  
**Model: SE9480U**  
**RFID System**  
**Model: 050-34901**

**Contains FCC ID: RPARFR6**

This device complies with Part 15 of the FCC Rules. Operation is subject to the following two conditions: (1) this device may not cause harmful interference, and (2) this device must accept any interference received, including interference that may cause undesired operation.

The user is cautioned that unauthorized changes or modifications not approved could the user's authority to operate the equipment.

NOTE: This equipment has been tested and found to comply with the limits for a Class B digital device, pursuant to part 15 of the FCC Rules. These limits are designed to provide reasonable protection against harmful interference in a residential installation. This equipment generates, uses and can radiate radio frequency energy and, if not installed and used in accordance with the instructions, may cause harmful interference to radio communications. However, there is no guarantee that interference will not occur in a particular installation. If this equipment does cause harmful interference to radio or television reception, which can be determined by turning the equipment off and on, the user is encouraged to try to correct the interference by one or more of the following measures:

- Reorient or relocate the receiving antenna.
- Increase the separation between the equipment and receiver.
- Connect the equipment into an outlet on a circuit different from that to which the receiver is connected.
- Consult the dealer or an experienced radio/TV technician for help.

**Contains IC: 4819A-RFR6**

Operation is subject to the following two conditions: (1) this device may not cause interference, and (2) this device must accept any interference, including interference that may cause undesired operation of the device.

CAN ICES-3(B)/NMB-3(B)

Perchlorate Material-special handling may apply, See [www.dtsc.ca.gov/hazardouswaste/perchlorate](http://www.dtsc.ca.gov/hazardouswaste/perchlorate)

This product may contain certain substances which are restricted when disposed.

Therefore, be sure to consult your contracted service dealer.

**Warning**

**For SE9380A Model Only**

This is a Class A product. In a domestic environment this product may cause radio interference in which case the user may be required to take adequate measures.

**For SE9380E Model Only**



**R&TTE directive Class1 device**

- This product contains RFID (Radio Frequency Identification) System.

## Notice for European Union Member States

### RISO, the environment and the Waste Electrical and Electronic Equipment Directive "WEEE Directive"

#### What is the WEEE Directive?

The purpose of the WEEE Directive is to reduce waste and ensure Electrical and Electronic Equipment is recycled at the end of its useful life.



#### What does the crossed out wheeled bin symbol mean?

The crossed out wheeled bin symbol indicates this product must be disposed of separately to normal waste.

Please contact your RISO service agent for information about disposal.

#### What does the solid bar symbol mean?

The solid bar under the crossed out wheeled bin indicates this product was put on the market after the 13th August 2005.

#### Who should I contact if I want more information about the WEEE Directive?

You should contact your local RISO service agent for more information.

**Riso shall not be responsible for any damage or expense that might result from the use of this manual.**

**As we are constantly improving our products, the machine may differ in some respects from the illustrations used in this manual.**

**Riso shall not be liable for any direct, incidental, or consequential damages of any nature, or losses or expenses resulting from the use of this product or included manuals.**

** Caution:**

- Make sure to read the important operational safety information.
- Store this manual close-by, and fully acquaint yourself with the printing machine.

**RISO** is a registered trademark of RISO KAGAKU CORPORATION in Japan and other countries.

**riso iQualitySystem™** is a trademark of RISO KAGAKU CORPORATION.



is a trademark of RISO KAGAKU CORPORATION.

**Adobe® Reader® and Adobe® Acrobat® Reader® are either registered trademarks or trademarks of Adobe Systems Incorporated in the United States and/or other countries.**



**Acquisition of Color Universal Design Certification**

The RISO SE9480/9380 (machine, printer driver\*) is recognized by the incorporated non-profit organization Color Universal Design Organization (CUDO) in achieving Color Universal Design.

\*Windows version

**- The information contained in this document is subject to change without notice.**

# Contents

Welcome to the SE Series Model.....	7
About This User's Guide.....	7
Icons Used in This Manual.....	8

## **Before Starting to Use** **10**

---

Safety Guide - Installation.....	10
Installation.....	10
Power connection.....	10
Grounding.....	11
Safety Guide - Handling and Operation.....	12
Operation Environment.....	12
Machine Handling.....	12
USB Flash Drive.....	13
Consumables.....	13
Ink Handling.....	13
Location of Caution Label.....	13
Connection with a Computer.....	14
Connection Method.....	14
Software Installation.....	15
Paper Recommendations.....	16
Size and Weight Restrictions.....	16
Tips for Better Paper Feeding.....	17
Storing Environment.....	17
Originals.....	18
Size and Weight Restrictions.....	18
Maximum Printing Areas and Margins.....	19
Materials Not to Be Printed.....	19

## **Getting Acquainted** **20**

---

Function and Name of Each Part.....	20
Optional Devices.....	23
Control Panel.....	24
Display.....	26
The Screens and their Various Stages.....	26
About Modes.....	28
Basic Screen Layout.....	31
Basic Process.....	33
Printing from a Paper Document.....	33
Printing from a Computer Data.....	33

<b>Basic Operations</b>	<b>34</b>
Preparing to Print.....	34
Setting up the Paper Feed Tray and Loading Paper .....	34
Setting up the Paper Receiving Tray .....	37
Setting up the Auto-control Stacking Tray (Optional) .....	39
Placing the original .....	41
When placing on the Glass Platen .....	41
When placing in the ADF unit (Option).....	41
Printing from a Paper Document or Book.....	43
Printing from a Computer Data [Direct Print] [USB Job List] .....	48
Printing Computer Data [Direct Print] .....	50
Printing USB Data [USB Job List].....	53
Changing Output Directions .....	55
Changing Stop Timing .....	57
<b>Functions for Master-Making</b>	<b>58</b>
Selecting Image Processing Mode [Image] .....	58
Selecting Scanning Contrast for the Original [Contrast] .....	60
Enlarging/Reducing Originals [Standard Ratio] [Margin+] [Auto] [Free] [Zoom] .....	61
Enlargement and Reduction by Standard Ratio	
[Standard Ratio] [Margin+] [Auto] .....	62
Enlargement/Reduction of a Changed Aspect Ration [Free].....	63
Enlarging and Reducing with the Zoom Function [Zoom] .....	64
Using Custom-Sized Paper [Paper] .....	65
Automatic Printing [Auto-Process] .....	66
Processing Photos with Dot Screen [Dot Process] .....	67
Adjusting Photo Contrast [Contrast Adj].....	68
Adjusting Photo Gradation [Tone Curve].....	69
Saving Ink [Ink Saving] .....	70
Printing Multiple Originals on One Sheet [2 Up] [Multi-Up Print] .....	71
Original Orientation and Print Results .....	72
Margin.....	74
Orientation of Print Paper .....	74
Multi-Up Interval .....	74
2 Up Operation .....	75
Operation for Multi-Up Printing .....	76
Operation for Multi-Up Tickets.....	78
Laying out continuous originals on one sheet of paper [Layout] .....	80
Printing from Bound Documents [Book Shadow] .....	84
Erasing Shadows when Printing.....	85
Splitting Facing Pages of a Bound Original when Printing [Page split] .....	86
Cutting the Top Margin of the Original and Printing [Top Margin] .....	87
Adjusting the Master-Making position [Binding Margin].....	88
Making a Master that Utilizes the Maximum Printing Area [Max. Scan] .....	90
Rotating the Original 180 Degrees to Make a Master [Rotate].....	91

Checking the Print Image Prior to Making Master [Preview] .....	92
Actions Available on the Preview Screen .....	93
Checking and Printing the Preview Display .....	93

## **Functions for Printing 96**

Changing the Print Speed [Print Speed Adjustment] .....	96
Printing at High Speed [High Speed].....	97
Printing More Quietly [Silent] .....	98
Adjusting the Print Density [Print Density Adjustment] .....	99
Adjusting the Print Position [Print Position Adjustment] .....	100
Printing Proof Copies [Proof] .....	102
Prevent Paper Jams When Using Special Paper [D-Feed Check].....	103
Extending the drying time [Interval] .....	104
Paper Feed/Output Settings for Special Paper and Printing Types [Jump Wing Control] [Special Paper Ctrl].....	105
Setting the Jump Wing Control [Jump Wing Control] .....	106
Saving Settings and Renaming the Parameter Names in the Parameter List.....	107
Retrieving Settings from the Parameter List.....	109
Making changes to Special Paper Ctrl Setting .....	110
Clearing Special Paper Ctrl Settings .....	111
Adjusting the Auto-control Stacking Tray (when using the optional Auto-control Stacking Tray) [Receive Tray] .....	112

## **Advanced Features 114**

Setting Up User Management [User Management].....	114
Functions of User Management .....	114
Operation flow of User Management.....	116
Selecting Recognition and Identification System.....	117
Setting Up the Management Level .....	119
Registering Administrator/Users .....	120
Changing Administrator/User Registration .....	125
Clearing User Registration .....	126
Renaming Groups .....	127
Reset All User Counters .....	128
Automatic Sorting Into Groups [Program] .....	129
How to Program Print .....	131
Setting Up for Programed Printing.....	132
Saving Programs .....	134
Renaming a Program .....	135
Retrieving a Program.....	137
Clearing Programs.....	138
Making changes to Stored Programs .....	139
Using Job Memory Functions [Job Memory] .....	140
Storing Job Memory .....	141
Renaming a Job Memory .....	142
Retrieving a Job Memory and Printing .....	144
Clearing Job Memory .....	146
Protecting Confidential Documents [Confidential] .....	147

Extending the Reserve Period [Reservation] .....	148
Idling Action [Idling Action] .....	149
Reproducing the Master [Renew Page][Auto Page Renewal].....	150
Using Page Renewal .....	151
Using Auto Page Renewal.....	152
Print the original from the last page [Output reversal] .....	153
Proof and Print (only when the ADF unit is installed) [ADF Semi-Auto] .....	155
Selecting Scanning Sides When Using the Auto Document Feeder DX-1 [Scanning Side -ADF] .....	156
Specifying the Scanning Side.....	158
Checking User Counters [ID Counter Report] .....	160
Outputting the Counter Report .....	161
Setting Up the Monthly Reminder.....	162
Showing Usage Status [Meter Display] .....	163
Customizing the Direct Access Area [My Direct Access] .....	164
Changing Default Settings [Admin.] .....	166
Configurable Functions.....	166
Customizing the Default Settings .....	173
Setting Up Direct Access Area and Selections Tab [DirectAccess Entry] [Selections Entry] .....	176
Registering a Custom Paper Size [Custom Paper Entry].....	178
Entering sizes and changing names.....	178
Deleting a Custom Paper Size .....	181
Keeping Masters Secure After Printing [Protect].....	182
Preventing Leaks of Masters After Creation or Disposal .....	183

## **Storing Original Data and Use Method 186**

Converting Hard-copies to Stored Data [Scan Mode] .....	188
Scanning a Hard-copy Original.....	189
Setting Data Information.....	190
Specifying Stored Size .....	192
Retrieving Stored Data and Printing [Storage Memory][USB Job List].....	193
Retrieving Stored Data .....	193
Changing the Data Order .....	195
Using the Storage Retrieve/USB Job List Screen .....	196
Overlaying Storage Data onto a Print Job [Overlay].....	197
Copying/Moving Stored Data.....	199

---

<b>Replacing Consumables</b>	<b>202</b>
------------------------------	------------

---

Check for Remaining Amount of Consumables.....	202
Replacing the Master Roll .....	204
Replacing the Ink Cartridge .....	207
Emptying the Master Disposal Box .....	209
Replacing the Print Drum (Cylinder).....	211
Removing the Print Drum (Cylinder).....	211
Installing the Print Drum (Cylinder).....	213
Disposal of Depleted Consumables .....	214

<b>Maintenance</b>	<b>216</b>
--------------------	------------

---

Cleaning .....	216
Thermal Print Head .....	217
Glass Platen and Platen Cover Pad .....	217
Scanner Glass and White Sheet of ADF unit (Option) .....	218
Pressure Roller .....	219
The Exterior .....	220

<b>Troubleshooting</b>	<b>222</b>
------------------------	------------

---

When a Message Displays .....	222
Error Message Layout .....	222
Pop-Up Message Layout .....	232
Consumable Information Screen .....	241
Troubleshooting.....	244

<b>Appendix</b>	<b>256</b>
-----------------	------------

---

Optional Accessories.....	256
Specifications .....	257
Index.....	262



---

# Welcome to the SE Series Model

Thank you for your purchase of this printing machine.

This machine is a digital printer-duplicator with the following functions.

- This machine is equipped with an easy-to-use Touch Screen LCD display and features.
- With an interactive guidance system, highly-sophisticated printer settings can be made with ease.
- 180ppm/185ppm ultra high speed printing gets the job done faster than ever before.
- 600dpi resolution High Quality printing will give you clear and crisp documents.

## About This User's Guide

This machine comes with the following four user's guides.

### ◆ RISO SE9480/SE9380 User's Guide (this manual)

This user's guide explains basic printer operations, handy tips, and how to set up the high-speed print function. It also contains user cautions, information on storing and changing consumables, and troubleshooting procedures.

### ◆ RISO Editor User's Guide

This user's guide explains the RISO Editor functions.

### ◆ RISO Printer Driver User's Guide (included as a PDF file in the attached CD-ROM)

This user's guide explains the procedures for printing from a computer.

### ◆ RISO Utility Software User's Guide (CD-ROM)

This user's guide explains how to use the "RISO COPY COUNT VIEWER" and "RISO USB PRINT MANAGER".

This manual shows you the machine's basic and advanced operations using various functions. It also contains cautionary notes, usage and replacement information on consumable supplies and troubleshooting tips.

Please read this manual carefully before using this machine. Reference at any time as needed for more tips and ideas.







---

# Icons Used in This Manual

The following icons are used in this manual.

## About the notation

The following icons are used throughout the document.

 <b>WARNING:</b>	Ignoring this warning could cause death or serious injury.
 <b>Caution:</b>	Ignoring this caution could cause injury or damage to property.
<b>Important!:</b>	Indicates items that require special attention or that are prohibited actions. Read carefully and follow the directions as instructed.
<b>Note:</b>	Gives you useful information.
<b>Tip:</b>	Gives you additional hints for more convenience.
	Indicates a reference page.
[ ]	Indicates a button or an item name on the LCD display.
	Indicates which button to touch on the LCD display.
	Indicates the original document.
	Indicates printed copies.

# The notation for Operational Instructions and Function Descriptions

The following conventions are used to explain functions and operations.

1

Functions for Master-Making

## Functions for Master-Making

### Selecting Image Processing Mode [Image]

In order to make a master best suited for the original document, select an appropriate mode depending on what original contains only text (Line), photo, or both of them.

**Note:**

- Default Image Processing mode can be set on the Admin. Screen. (p.168)

2 Touch [Page] on the Master Making Basic Screen.

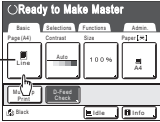

3 Select the appropriate Image Processing mode for the original.



• [Line] Only text contained; e.g., text document, newspaper

• [Photo] Only photos contained

• [Duo] Both text and photos contained

• [Pencil] pencil drawings or tightly printed documents

Touch [Photo], [Duo] or [Pencil] to see detailed settings.

Image (Detailed settings)	Description
[Photo]	Select for photos other than or [Group].
Standard	Select for photos other than or [Group].
Portrait	Use this setting for pictures of two individuals from the bust type of image processing is good for printing photos of
Group	This setting is for group photos over-exposed. This process for restoring facial features become washed out by a bit. The Group setting is not for faces that are overly dark. It is more effective to select [Standard] such photos.
[Duo]	
Line	Select to print small text clearly
Photo	Select to print photos more brightly.
Shadow off	Select to clear the background of the dark-color originals (such as newspapers). [Shadow off] is selectable [Line] and [Photo].
[Pencil]	
Darken	Select to print faint originals
Lighten	Select to print cut-and-paste drawings with shadows.

3 Touch [OK].

Returns to the Master Making Basic Screen. Image Processing mode is updated.

**Note:**

- Some functions are not available in certain Image Processing mode settings.

	Line	Photo	Duo	Pencil
Dot Process	—	✓	✓	—
Contrast (Auto)	✓	—	—	—
Contrast (1-5)	✓	✓	✓	✓
Contrast Adj.	—	—	—	—
Tone Curve	—	✓	✓	✓

✓ : available    — : not available

- In the [Line] mode, when [Contrast] is set to [Auto], the background color of the original is automatically deleted. (p.82)

60 Selecting Image Processing Mode [Image] 61 Selecting Image Processing Mode [Image]

## 1) Chapter Title

## 2) Operation Procedure

The operational procedures are outlined in steps. Follow these steps.

## 3) Display

Shows the screen as seen at each step.

## About the content of this manual and the illustrations

- The illustrations included in this document depict the SE9380A model in most cases.
- Displays are illustrated as if currently activated. Some buttons mentioned in this manual may not be available in default setting, or when the optional device is not installed.
- The optional Auto Document Feeder AF-VI:II and Auto Document Feeder DX-1 are collectively described as the "ADF unit".
- In this manual, the optional memory card DM128-CF and memory card DM512-CF are collectively described as the "memory card".

### Important!:

- Measurements in the text body will be shown in both metric and inch (imperial) formats, but diagrams will show only metric measurements.

# Before Starting to Use

## Safety Guide - Installation

This section describes the precautions to be observed when installing the machine. Read this section before installing the machine.

### Note:

- Your dealer (or authorized service representative) will help you to determine a proper location for the machine at the time of delivery.

## Installation

---

### ⚠ WARNING:

- Place the machine on the dedicated stand for this model or on a flat and stable surface (maximum of 10 mm ( $25/64$  inches) differential allowed). Injury might occur if the machine falls.

### ⚠ Caution:

- Install the machine near the electrical outlet to avoid using an extension cord between the machine and the electrical outlet.
- Allow at least 10 cm (4 inches) or more of clearance behind the machine so that you can unplug the machine in case of technical difficulties.
- Keep the machine away from dusty environments. Failure to do so may result in fire.
- Install the machine in a well-ventilated area.

### Important!:

- Avoid installing the machine in the locations listed below. Failure to observe this precaution may lead to machine failure.
  - Locations with exposure to direct sunlight, such as locations close to windows (Curtain all windows that might expose the machine to direct sunlight)
  - Locations that are subject to sudden changes in temperature
  - Extremely hot and humid locations or cold and dry locations
  - Heated locations
  - Locations exposed to direct cold air, direct hot air, or direct radiant heat
  - Poorly ventilated locations

## Power connection

---

### ⚠ WARNING:

- Use with the machine's rated voltage value. Also, plug into an electrical outlet with a capacity larger than the rated current value.  
For the rated voltage value and rated current value, check the "Power Source" entry of the Specifications at the end of this manual.
- Do not overload the electrical outlet or extension cord, nor damage the power cord by placing heavy objects on it or pulling or bending it. This can result in fire or electric shock.
- Do not pull the power cord but hold the plug itself when unplugging it. This can damage the cord and result in fire or electric shock.
- Do not plug or unplug the power cord if your hands are wet. This can result in electric shock.

**⚠ Caution:**

- Pull out the power cord plug from the electrical outlet more than once a year and clean the prongs of the plug and their surroundings. Dust collected on these areas can result in fire.

**Important!:**

- Check the power cord and plug for poor connections. Plug the power cord securely into a nearby electrical outlet.
- Be sure to turn off the POWER switch when connecting or disconnecting a cable.

## Grounding

---

**⚠ Caution:**

- Ensure a power plug with a ground conductor is inserted into the wall outlet for proper grounding.
- When the machine is not grounded, a short circuit may occur, resulting in fire or electric shock.

# Safety Guide - Handling and Operation

This section describes the precautions to be observed when handling the machine. Read this section before operating the machine.

## Operation Environment

---

### Important!:

- Operate the machine under the following appropriate environment conditions.  
Temperature range: 15°C to 30°C (59°F to 86°F)  
Humidity range: 40% to 70% (noncondensing)

## Machine Handling

---

### WARNING:

- Do not place water containers or metallic objects on the machine. Fire or electric shock may occur if water or metallic objects fall into the machine.
- Do not use combustible spray and flammable solvent near the machine.  
If sprayed gas and flammable solvent contact electronic components inside the machine, fire or electric shock might occur.
- Do not insert any metallic material or flammable substance into the machine through any opening. This can result in fire or electric shock.
- Do not remove machine covers. Exposing internal parts may result in electric shock.
- Do not disassemble or rebuild the machine by yourself. This can result in fire or electric shock.
- If the machine emits excessive heat, smoke or foul odor, immediately turn off the POWER, unplug the power cord and contact your dealer (or authorized service representative). Failure to do so can result in fire or electric shock.
- If something drops inside the machine, immediately turn off the POWER, unplug the power cord and contact your dealer (or authorized service representative). Failure to do so can result in fire or electric shock.
- Never stick your hands or fingers in the openings of the machine during operation.
- Keep loose clothing or long hair away from moving parts to avoid becoming entangled.
- Do not place heavy objects on the machine. The objects might fall and cause injury.
- Contact your dealer (or authorized service representative) before moving the machine.

### Caution:

- Never insert fingers, etc. into the openings around Paper Feed Tray and Paper Receiving Tray. This can result in injury.
- Do not touch the moving parts of the machine. This may cause injury.
- When you insert a hand inside the machine to remove paper, etc., be careful not to touch protruding objects or the edges of the plates. This may cause injury.
- Be careful not to touch the areas around the Print Drum (Cylinder) or inside the machine when the Print Drum (Cylinder) is removed, as Ink may be present on those areas.  
When Ink has stuck to your hands, etc., wash it off with detergent as soon as possible.
- The tips of the paper separation hook and master removal hook are sharp. When you insert a hand inside the machine to remove paper, be careful not to touch the paper separation hook or master removal hook. This may cause injury.
- Do not open any covers or move the machine during operation.
- Unplug the power cord, if you do not use the machine for a long time.
- The machine has precision parts and driving parts inside. Do not handle the machine in other ways than described in this manual.
- Do not subject the machine to physical shock.
- Do not stand the Print Drum (Cylinder) vertically. Doing so may pollute the floor, etc.
- Allow plenty of ventilation during printing.

### Important!:

- Do not unplug the power cord or turn off the power during operation.
- Be sure to open and close all machine covers gently.

## USB Flash Drive

### Important!:

- Use a USB Flash Drive that is compatible with the Mass Storage Class. Depending on the types of USB Flash Drive, the machine may not work properly.
- When connecting or disconnecting the USB Flash Drive, follow the proper procedures.
- We cannot guarantee data saved in the USB Flash Drive against loss caused by accidents or unforeseen events. We recommend that you use your computer to make back-up copies of any important documents.

## Consumables

### Important!:

- For Ink and Master Roll, it is recommended to use the products specified by Riso.
- Genuine RISO Inks and Master Roll are engineered for maximum performance and maximum life. However, all supplies can and do deteriorate over time. We recommend that you use Ink and Master Roll as soon as possible after purchase, and within 18 months from the date of manufacturing. You can find the date of manufacturing on the Ink Cartridge or the inside of Master Core.
- Store consumables such as Master Roll and Ink properly.  
Do not store the consumables in the following places:
  - Locations that are subject to direct sunlight or bright locations that are close to windows (If there is no other choice, curtain the window.)
  - Locations that are subject to rapid changes in temperature
  - Extremely hot and humid locations or extremely cold and dry locations

For more details, please read the packaging of the consumables.

## Ink Handling

### ⚠ Caution:

- If Ink gets into your eyes, flush it out immediately with plenty of water. If irritation continues, seek medical attention.
- If Ink comes into contact with your skin, wash it off thoroughly using soap.
- If someone swallows Ink by mistake, force large quantities of water (or milk) without inducing vomiting, and watch his/her condition.
- Allow plenty of ventilation during printing.
- If you feel unwell during use, seek medical advice.
- Only use the Ink for printing purposes.
- Keep the Ink out of the reach of children.

## Location of ⚠ Caution Label

This machine has a ⚠ caution label meant to ensure safe operation. Follow the indication of the label and use the machine safely.

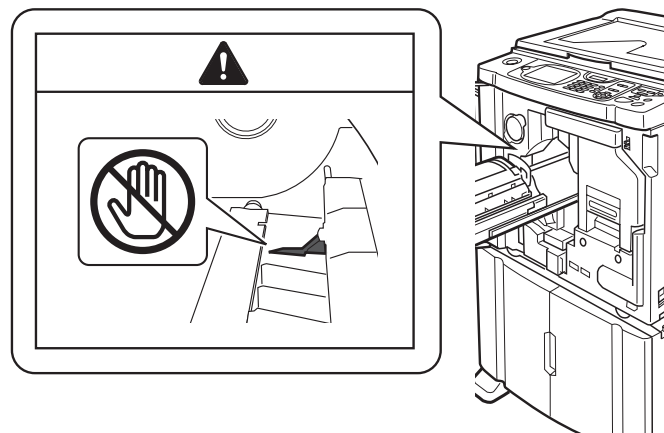

# Connection with a Computer

You can directly send original printing data from a connected computer to the machine. The machine produces outstanding prints as a result of using digital data to make a master.

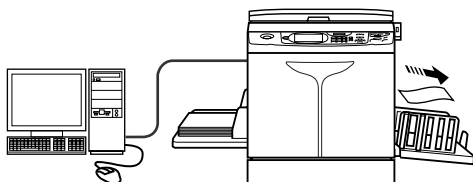

## Connection Method

### ◆ One-to-one connection with a Windows PC

- Cable:  
USB cable  
Less than 3m (10 feet) Hi-Speed USB

#### Important!:

- Before connecting the USB, turn on the machine and computer, and wait until the initial screen is displayed.
- The maximum allowable voltage for USB connector input and output is 5 V.
- For the USB connections, use a commercially available USB cable (that conforms to the USB 2.0 standard).

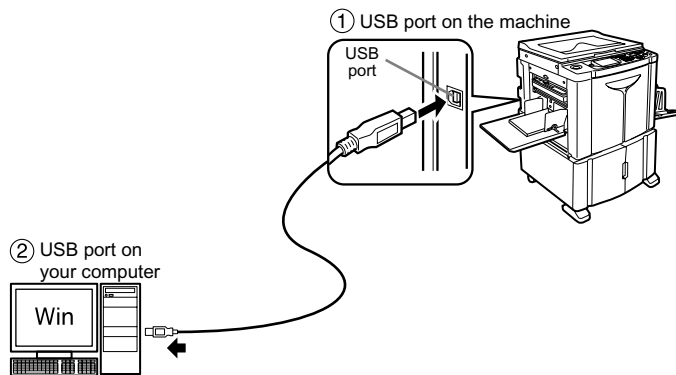

### ◆ Network connections

- Cable:  
Ethernet cable  
Shielded cable that supports 10BASE-T or 100BASE-TX

#### Important!:

- Before making the Ethernet connections, turn off the machine and computer.

#### Note:

- The RISO Network Card is required.

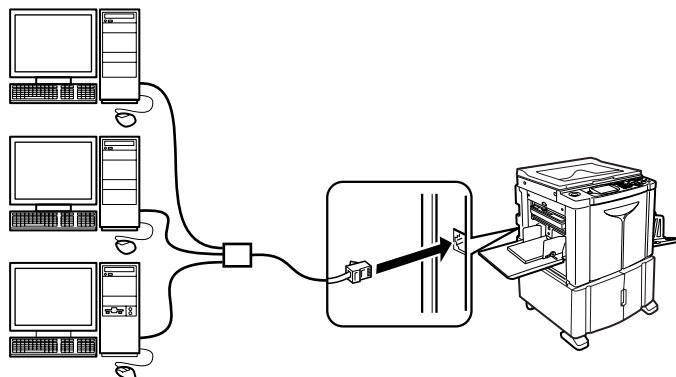



---

## Software Installation

---

Before printing from a computer connected to the machine via a USB cable, the RISO Printer Driver must be installed. Before printing from a computer connected to the machine via a network, both the RISO Printer Driver and RISO Network Card must be installed. Refer to the Printer Driver User's Guide and RISO Network Card User's Guide for instructions on installation.

The software supplied with this machine is as follows:

### ◆ RISO Printer Driver

RISO Printer Drivers are for use with RISO Printers only.

Before setup, be sure to read the User's Guide carefully.

The User's Guide can be found as a PDF file\* in the CD-ROM which came with the RISO Printer.

\*To be able to view PDF format files, it is necessary for either Adobe Reader or Adobe Acrobat Reader to be installed.

Adobe Reader or Adobe Acrobat Reader software can be freely downloaded from the Adobe website (<http://www.adobe.com/>).

### ◆ RISO Utility Software

The software package includes the "RISO USB PRINT MANAGER" and "RISO COPY COUNT VIEWER".

- "RISO USB PRINT MANAGER"  
Application that manages the original data stored in the USB Flash Drive on the computer.
- "RISO COPY COUNT VIEWER"  
Application that manages the counter data (number of prints, masters, etc.) output to the USB Flash Drive on the computer.

# Paper Recommendations

## Size and Weight Restrictions

The table shows the specifications of the usable print paper.

Usable Printing Paper	
Size	Weight
Minimum Size 100 mm × 148 mm (3 <sup>15</sup> / <sub>16</sub> " × 5 <sup>13</sup> / <sub>16</sub> " ) Maximum Size 320 mm × 432 mm (12 <sup>19</sup> / <sub>32</sub> " × 17")*	46 g/m <sup>2</sup> to 210 g/m <sup>2</sup> (12-lb bond to 110-lb index)

\*Up to 555 mm (21<sup>27</sup>/<sub>32</sub>" ) of vertical paper dimension may be used when the machine is on "Extended Paper" mode  
 ↗ p.178, ↗ p.180

### Important!:

- Even when using paper whose sizes and weight are supported by the machine, it may not pass through the machine depending on factors such as the paper quality, ambient conditions, and storage conditions. For more information, consult your dealer (or authorized service representative).

Do not use the following types of paper, as they can cause jams or misfeeds:

- Extremely thin paper  
 Using the Paper Feed Tray: less than 46 g/m<sup>2</sup> (12-lb bond)
- Extremely thick or heavy paper  
 Using the Paper Feed Tray: greater than 210 g/m<sup>2</sup> (110-lb index)
- Wrinkled, curled, folded, or torn paper
- Chemically treated or coated paper (such as thermal or carbon paper)
- Paper having a sticky section or holes (such as an envelope and label paper)

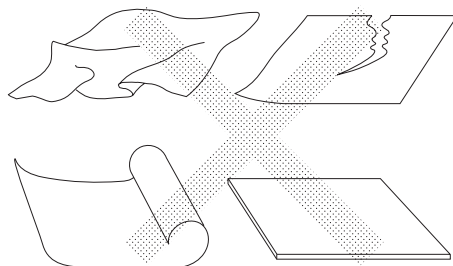

### Note:

- Paper with a horizontal grain direction can cause problems with paper supply. Use paper with a vertical grain direction.
- Images are not output onto the entire area of usable print paper. The maximum printing areas differ among models.  
 ↗ p.19
- When using poorly cut paper or coarse surfaced paper (drawing paper, etc.), arrange the paper neatly before use.
- Depending on the type of paper used, paper dust may be generated when using the machine. Please clean and ventilate the area adequately.

Riso does not assure that paper outside the above specifications can pass through the machine and can be used for printing.

---

## Tips for Better Paper Feeding

---

To prevent paper jams and misfeeds, follow the directions below:

- When using standard or light-weight paper, set the Paper Feed Pressure Adjustment Lever to “NORMAL” (✕). Then open all four Paper Arrangers. [p.35](#), [p.36](#)
- When using thick paper (such as card stock), set the Paper Feed Pressure Adjustment Lever to “CARD” (✕), and open the two inner Paper Arrangers. [p.35](#), [p.36](#)
- When using slippery paper, set the Paper Feed Pressure Adjustment Lever to “CARD” (✕). [p.35](#), [p.36](#)
- Use flat printing paper that is free of folds. If curled paper is unavoidable, place the printing paper so that the curl faces down.
- Paper may stick to the Print Drum (Cylinder) surface if the top margin is too narrow on the original or if the upper portion of the original uses a large amount of ink. To solve this problem, lower the print position to provide a wider top margin or reverse the top and bottom of the original. Then restart printing from the beginning.

---

## Storing Environment

---

Store the printing paper in a level, dry area. Storing the paper in an excessively humid area can result in paper jams or poor print quality.

After unpacking the printing paper, keep the remaining paper wrapped and store it in a moisture-proof box. It is highly recommended to put silica gel in the paper storage box.

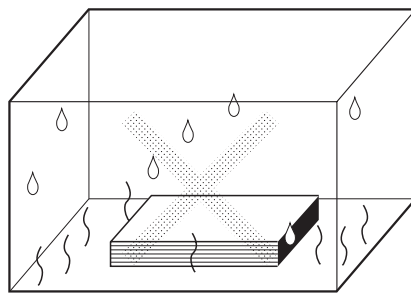

# Originals

## Size and Weight Restrictions

Usable originals are as follows.

Used Device Name	Size	Weight
Glass Platen	50 mm × 90 mm to 310 mm × 432 mm (1 <sup>31</sup> / <sub>32</sub> " × 3 <sup>17</sup> / <sub>32</sub> " to 12 <sup>7</sup> / <sub>32</sub> " × 17")	Max. 10 kg (22 lb)
Document Feeder AF-VI:II (Option)	100 mm × 148 mm to 310 mm × 432 mm (3 <sup>15</sup> / <sub>16</sub> " × 5 <sup>13</sup> / <sub>16</sub> " to 12 <sup>7</sup> / <sub>32</sub> " × 17")	50 g/m <sup>2</sup> to 128 g/m <sup>2</sup> (13-lb bond to 34-lb bond)
Document Feeder DX-1 (Option)	105 mm × 128 mm to 297 mm × 432 mm (4 <sup>1</sup> / <sub>8</sub> " × 5 <sup>1</sup> / <sub>32</sub> " to 11 <sup>11</sup> / <sub>16</sub> " × 17")	The weight differs depending on the setting on the scanning side. <Front Side -> <b>Simplex</b> > 40 g/m <sup>2</sup> to 128 g/m <sup>2</sup> (11-lb bond to 34-lb bond) <Back Side -> <b>Simplex or Duplex -&gt; Simplex</b> > 52 g/m <sup>2</sup> to 105 g/m <sup>2</sup> (14-lb bond to 28-lb bond)

\* The paper weight limit differs depending on which sides of the original are scanned. Scanning sides can be specified using "Scanning Side -ADF". [p.156](#)

- Originals are scanned according to the size of paper placed on the Paper Feed Tray when masters are made. Position the Feed Tray Paper Guides to the same width as the original.  
When the paper placed is smaller than the original, the entire original will not be scanned.  
When the placed paper is larger than an original, dirt on the glass or shade of the original, may result in unexpected dirt in the area beyond the size of the original.
- Bound originals can also be used on the Glass Platen.
- You can automatically feed up to 50 original sheets 80 g/m<sup>2</sup> (21-lb bond) when using the optional ADF (Auto Document Feeder) unit.

### Note:

- Use the Glass Platen when printing the following originals:
  - Patched or worn originals
  - Wrinkled, curled, folded, or torn originals
  - Transparent originals (such as tracing paper or OHP transparencies)
  - Chemically treated originals (such as thermal or carbon paper)
  - Originals with correction fluid or glue
  - Extremely thin originals  
Using the optional Auto Document Feeder AF-VI:II: less than 50 g/m<sup>2</sup> (13-lb bond)  
Using the optional Auto Document Feeder DX-1:  
less than 40 g/m<sup>2</sup> (11-lb bond) (Front Side -> Simplex) / less than 52 g/m<sup>2</sup> (14-lb bond) (Duplex -> Simplex)
  - Extremely thick originals  
Using the optional Auto Document Feeder AF-VI:II: greater than 128 g/m<sup>2</sup> (34-lb bond)  
Using the optional Auto Document Feeder DX-1:  
greater than 128 g/m<sup>2</sup> (34-lb bond) (Front Side -> Simplex) / greater than 105 g/m<sup>2</sup> (28-lb bond) (Duplex -> Simplex)
  - Heavy drawing paper
  - Originals with staples or clips
- If an original is wrinkled, curled, or creased flatten it thoroughly so that the originals can be pressed directly onto the Glass Platen during processing.

- If correction fluid or glue is used on an original, thoroughly dry it before placement.
- If an original is patched with a thick paper, the shade of the patched paper may also be printed.

## Maximum Printing Areas and Margins

The maximum printing areas are as follows.

Model	Maximum Printing Area	Usable Maximum Print Paper Size
SE9480	291 mm × 425 mm (11 <sup>15</sup> / <sub>32</sub> " × 16 <sup>23</sup> / <sub>32</sub> " )	320 mm × 432 mm (12 <sup>19</sup> / <sub>32</sub> " × 17" )
SE9380	291 mm × 413 mm (11 <sup>15</sup> / <sub>32</sub> " × 16 <sup>1</sup> / <sub>4</sub> " )	

### Important!:

- Even when paper of maximum size (320 mm × 432 mm (12<sup>19</sup>/<sub>32</sub>" × 17" )) or Ext.Paper (top-bottom length up to 555 mm (21<sup>27</sup>/<sub>32</sub>" )) is used, printing is performed within the maximum printing areas mentioned above.
- Regardless of the size of the original, the printing area is decided by the paper size set in the Paper Feed Tray. The printing area is the printing paper size excluding the margins shown in the figure below. The original needs to be prepared with advanced consideration for the margins.

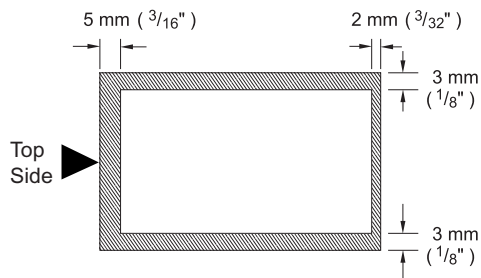

## Materials Not to Be Printed

Do not use the machine in any manner which violates the laws or infringes on established copyrights, even when making copies for personal use. Consult your local authorities for further details. In general, use discretion and common sense.

# Getting Acquainted

## Function and Name of Each Part

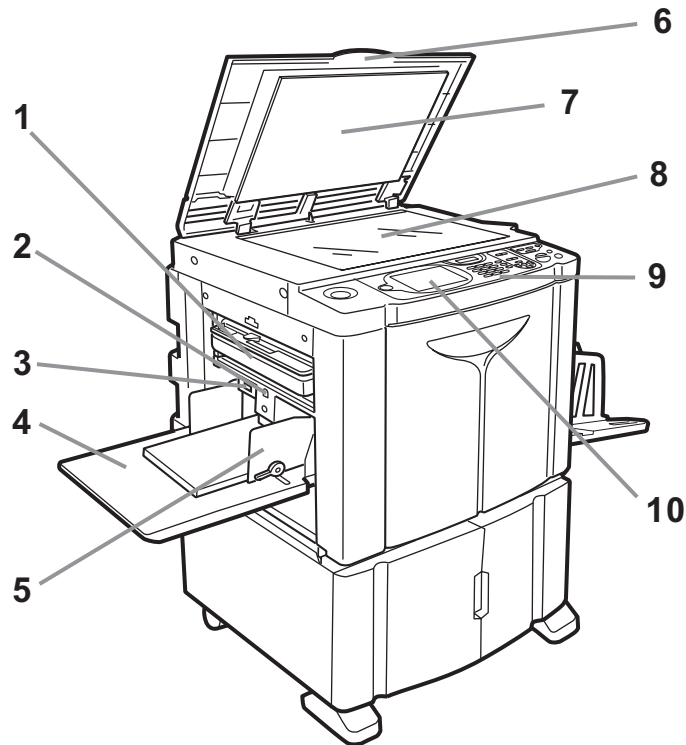

**1) Master Disposal Box (☞p.209)**

Holds discarded masters.

**2) Feed Tray Ascent / Descent Button (☞p.36)**

Lowers the Paper Feed Tray when changing or adding paper.

**3) Paper Feed Pressure Adjustment Lever (☞p.35)**

Adjusts the paper feed pressure according to the paper in use.

**4) Paper Feed Tray (☞p.34)**

Load print paper on this tray.

**5) Feed Tray Paper Guides (☞p.34)**

Hold and guide paper.  
Slide to fit to the sides of paper.

**6) Platen Cover**

Opened and closed when placing the original.

**7) Platen Cover Pad (☞p.217)**

**8) Glass Platen (☞p.41, ☞p.217)**

Place the original face-down.

**9) Control Panel (☞p.24, ☞p.25)**

Press the keys to perform various print operations.

**10) Display (☞p.26)**

Displays various screens needed for print operations.  
Touch the buttons on the screen to execute various print operations.

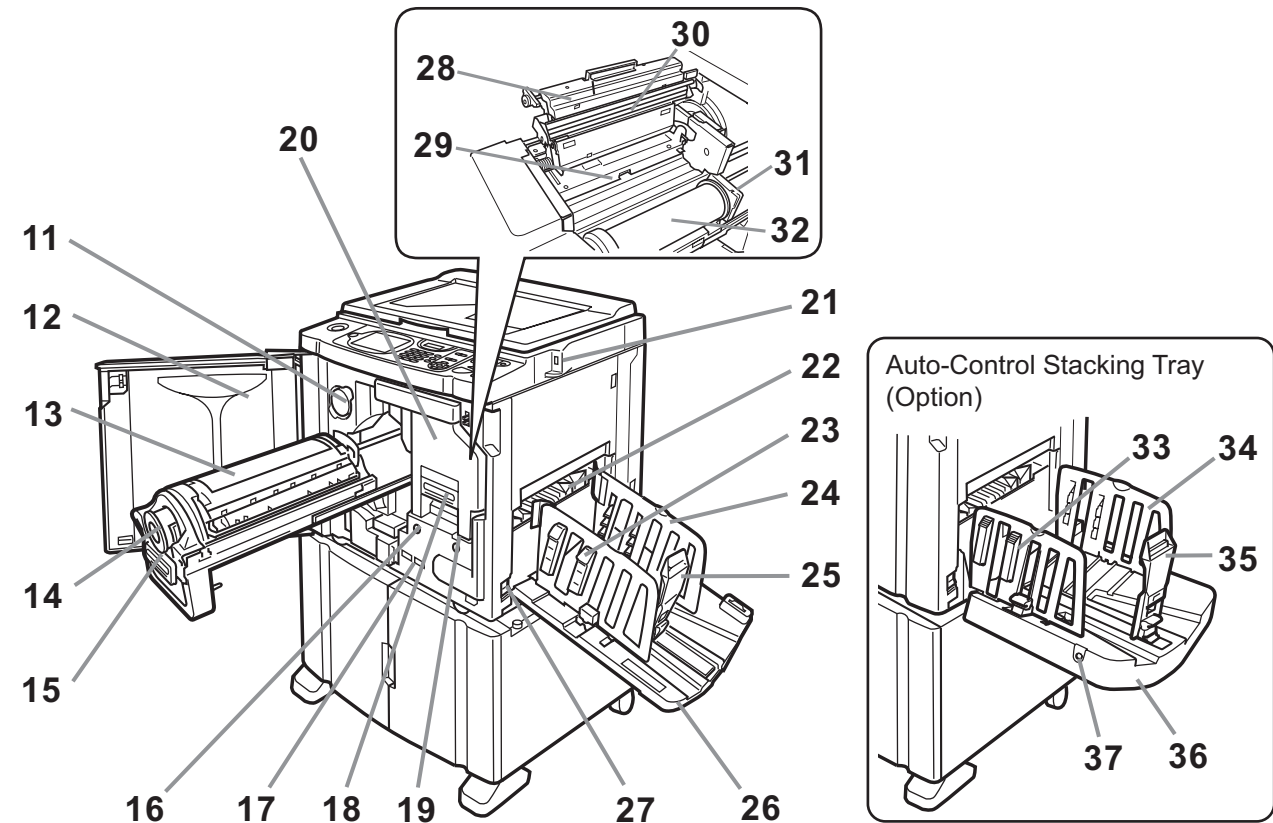

- 11) Ink Cartridge Cap Holder** (☞p.207)  
Secure the Ink Cartridge cap.
- 12) Front Cover**
- 13) Print Drum (Cylinder)** (☞p.211)
- 14) Ink Cartridge** (☞p.207)
- 15) Print Drum (Cylinder) Handle** (☞p.211)
- 16) Print Drum (Cylinder) Release Button** (☞p.211)  
Unlocks the Print Drum (Cylinder) for removal.
- 17) Counter**  
Counts the number of rotations of the Print Drum (Cylinder) (total Drum (Cylinder) rotation counter) and the number of masters made (master counter).
- 18) Master Making Unit Handle** (☞p.204)
- 19) Master Making Unit Release Button** (☞p.204)  
Unlocks the Master Making Unit for removal.
- 20) Master Making Unit** (☞p.204)
- 21) USB Slot** (☞p.46)  
Connect the USB Flash Drive.
- 22) Paper Jumping Wing** (☞p.106)  
Automatically adjusts to keep the printed paper neatly stacked.
- 23) Paper Arranger** (☞p.37)  
Press to open for aligning the printed paper.
- 24) Receiving Tray Paper Guides** (☞p.37)  
Aligns the printed paper neatly.  
Slide according to the width of paper to be printed.
- 25) Paper Stopper** (☞p.37)  
Slide to adjust to the length of print paper size.
- 26) Paper Receiving Tray** (☞p.37)  
Printed copies are output to this tray.
- 27) Power Switch** (☞p.34)
- 28) Master Making Unit Cover** (☞p.204)  
Open and close to install the Master Roll.
- 29) Master Guide Flap** (☞p.204)
- 30) Thermal Print Head** (☞p.217)
- 31) Master Roll Holder** (☞p.204)
- 32) Master Roll** (☞p.204)
- 33) Paper Arranger** (☞p.39)  
Press to open for aligning printed paper.
- 34) Receiving Tray Paper Guides** (☞p.39)  
Aligns printed paper neatly.  
Automatically adjusted to the width of paper to be printed.
- 35) Paper Stopper** (☞p.39)  
Automatically adjusted to the length of print paper size.
- 36) Auto-control Stacking Tray** (☞p.39)  
Printed copies are output to this tray.
- 37) Receiving Tray Paper Guides' Opening Button** (☞p.22, ☞p.40)  
For details, refer to the next page.

**Tip:****Using the Receiving Tray Paper Guides' Opening Button**

The Opening Button for the Receiving Tray Paper Guides on the Auto-control Stacking Tray is used as follows, depending on machine status:

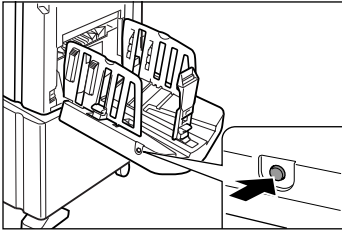

- **During standby:** when paper is discharged onto the Auto-control Stacking Tray
  - Press the Opening Button to open the Receiving Tray Paper Guides/Stopper so that paper can be removed.
- **During standby:** when the Auto-control Stacking Tray is empty
  - Press the Opening Button to move the Receiving Tray Paper Guides/Stopper to the storage position so that the Auto-control Stacking Tray can be closed.
- **During printing**
  - Press the Opening Button to move the Receiving Tray Paper Guides 1 mm ( $\frac{3}{64}$ " ) outwards each time. The Opening Button can be used in this way to jog paper on the receiving tray, etc.



## Optional Devices

### Auto Document Feeder AF-VI:II

The Feeder can hold approximately 50 original sheets (80 g/m<sup>2</sup> (21-lb bond)). Place the original face-down. (☞p.41)

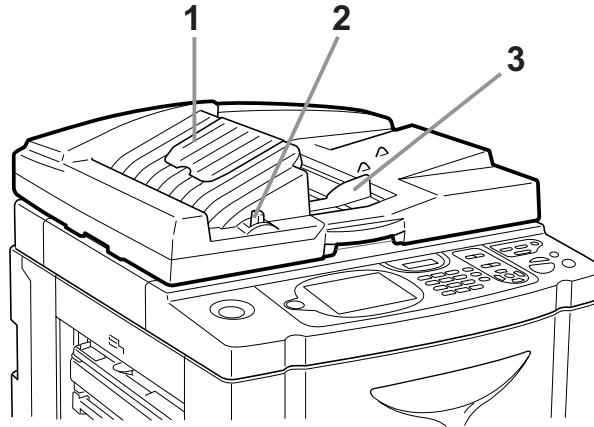

**1) ADF Original Receiving Tray**

Scanned originals are ejected into this tray.

**2) ADF Original Release Lever (☞p.228)**

If an original is jammed, pull this lever to the right to eject it from the ADF unit.

**3) ADF Original Guides**

Slide and adjust to the width of the originals to hold them together.

### Auto Document Feeder DX-1

The Feeder can hold approximately 50 original sheets (80 g/m<sup>2</sup> (21-lb bond)). (☞p.41)

Both sides of the original can be scanned automatically. Select the side (front or reverse) to be scanned. (☞p.158)

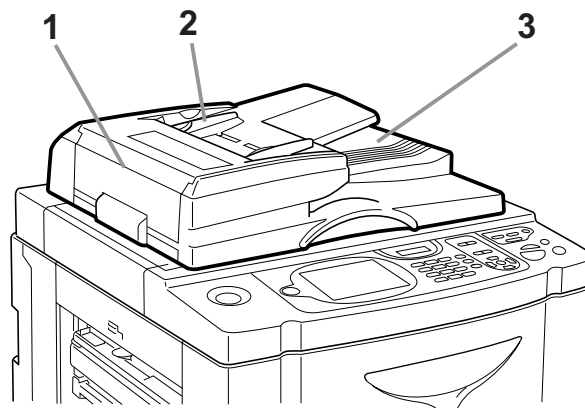

**1) ADF Cover (☞p.229)**

Jammed or misfed originals can be removed from the ADF unit by opening this cover.

**2) ADF Original Guides**

Slide and adjust to the width of the originals to hold them together.

**3) ADF Original Receiving Tray**

Scanned originals are ejected into this tray.

# Control Panel

The Control Panel features permanent keys such as  and . It also has a large-size display that shows various messages and function buttons.

This section describes hardware key names and functions, as well as the display window and its functions.

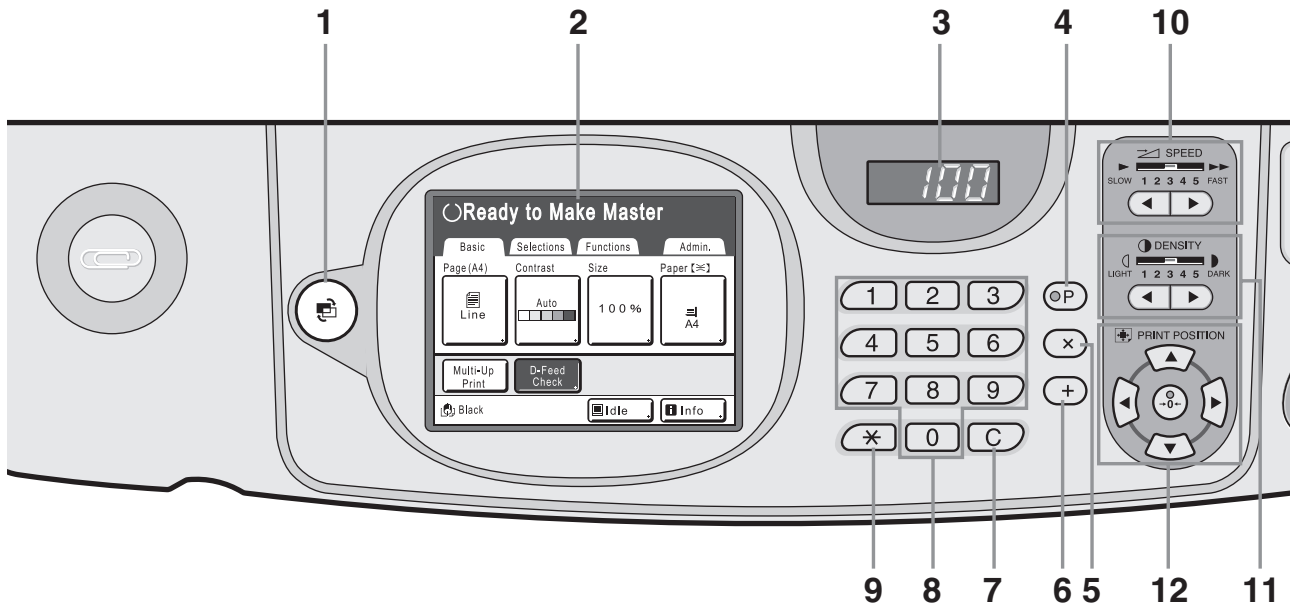

## 1) MODE Key (p.26, p.30, p.166)

Use to change modes.

## 2) Display (p.26 ~p.32)

## 3) Print Quantity Display

Displays the number of copies, or numeric values entered for various settings.

## 4) P Key (p.132)

Use to retrieve stored programs. The indicator on the key lights up when set.

## 5) × Key (p.132)

Use to move between the fields on Setup Screens, or set up programmed printing.

## 6) + Key (p.132)

Use to move between the fields on Setup Screens, or set up programmed printing.

## 7) C Key

Cancels the entered numerical values, or resets the counter to 0.

## 8) Print Quantity Keys (0 to 9 Keys)

Use to enter the number of copies, or the numerical values for various settings.

## 9) ✕ Key (p.129, p.140)

Use to move between the items on a Setup Screen, or retrieve the stored memory.

## 10) Print Speed Adjustment Keys / Indicator (p.96)

Select the print speed from five levels.

The indicator above the keys shows the current speed level.

## 11) Print Density Adjustment Keys / Indicator (p.99)

Select the print density from five levels.

The indicator above the keys shows the current density level.

## 12) Print Position Adjustment Keys / Indicator (p.100)

Adjust the print position in the horizon direction (within  $\pm 15$  mm ( $\pm 19/32$ ")) and in the vertical direction (within  $\pm 10$  mm ( $\pm 25/64$ )) after making a master.

The indicator above the keys shows the offset amount from the center.

To clear the offset amount, press .

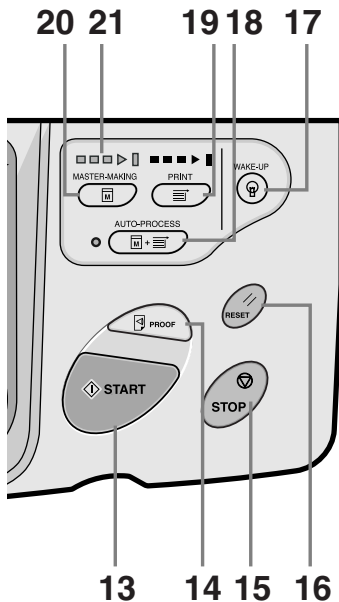
**13) Start Key**

Starts master-making, print processing, or executes specified operations.  
The key lights up only when the key is active.

**14) Proof Key (p.102)**

Use when you want to check the print result after adjusting the print position, for example.  
This allows you to print proof copies without affecting the value on the Print Quantity Display.

**15) Stop Key**

Stops current operation in progress. During the master-making procedure, the machine will not stop until the master-making process is completed.

**16) Reset Key**

Returns all settings to the initial settings, and clears the error screen on the display after a system error has been resolved.

**17) Wake-Up Key**

Wakes up the printer in Energy Saving mode.  
Also use this key to log out from the machine.

**18) Auto-Process Key (p.66)**

Performs non-stop operation from master-making through printing. When activated, the indicator besides the key lights up.

**19) Print Key**

Makes the printer ready for printing.

**20) Master-Making Key**

Makes the printer ready for making masters.

**21) Progress Arrows**

Indicates master-making and printing progress status.

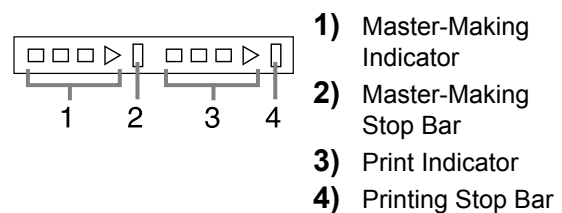

Ready to make a master (Auto ON): when 1 is lightening

Ready to make a master: when 1,2 are lightening

Ready to print: when 3,4 are lightening

The indicator increases one bar at a time from the left, indicating the progress of the current master-making or printing job.

- Indicator 1 or 3 blinks during the master-making/printing operation.
- If a master-making or printing job is halted, the progress bar stays lit at that position. (Ready to resume)



# Display

## The Screens and their Various Stages

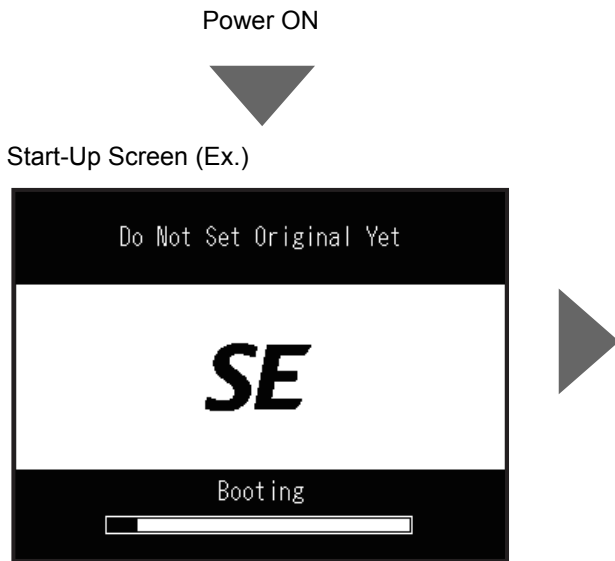
When the power is turned on, after a brief display of the Start-up Screen, the initial screen appears.



**Note:**

- Start-Up Screen settings  
Select **[Start-Up Screen]** on the Admin. Screen.
- Initial screen settings  
You can select **[Mode Screen]**, **[RISO Print]** or **[Scanning]** as the initial screen to best suit your needs.  
Select **[Display Priority]** on the Admin. Screen.  
Refer to the following pages for more information about the different types of initial screen.
- About the  key  
By pressing the  key, you can switch between the **[Mode Screen]** and **[Basic Screen]**. [p.30](#)

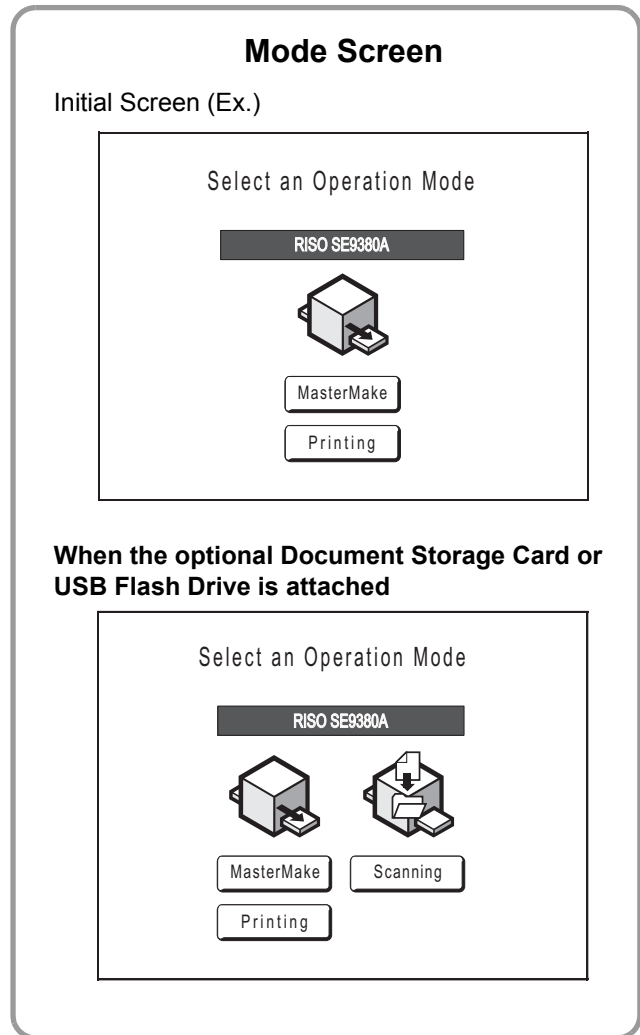

### Basic Screen

- Touch **[MasterMake]** to display the Master Making Basic Screen.

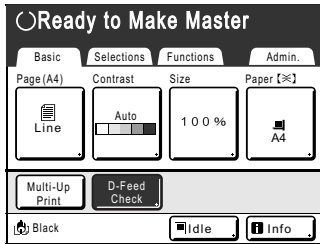

- Touch **[Printing]** to display the Print Basic Screen.

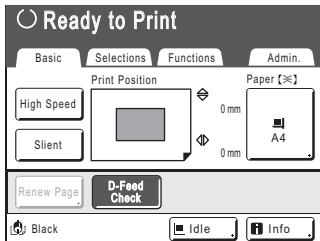

- Touch **[Scanning]** to display the Scan Basic Screen.

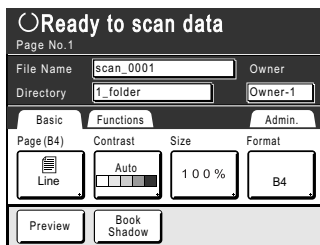

### Other Screens

#### ◆ Selections Screen

Quickly change the settings for a function or open its screen.

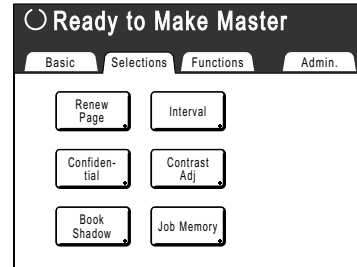

#### ◆ Functions Screen

Access to a variety of functions.

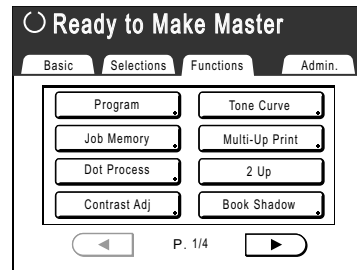

#### ◆ Admin. Screen

Changes the default values of various functions.

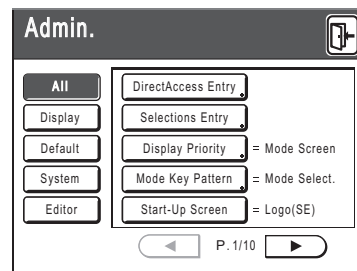
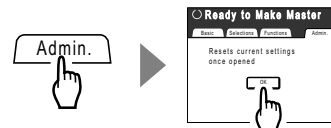

#### Note:

- Depending upon the usage environment, some of the "Admin." features may not be available ("Admin." tab may not be displayed). Consult your dealer (or authorized service representative) for details.

## About Modes

Touch the Mode button on the Mode Screen to view the Basic Screens of the various modes.

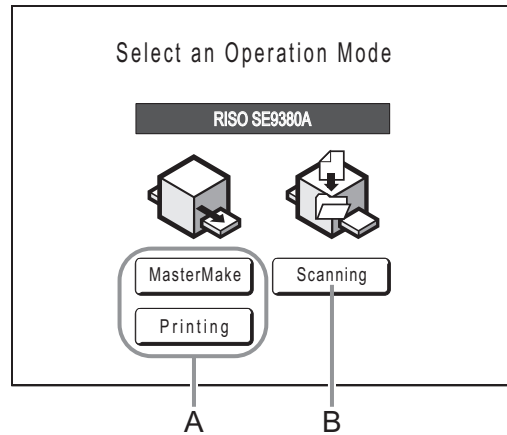

### A) RISO Print

On the Operation Screen displayed after selecting the Print Mode, you can select the operation of the machine (the operation that you are going to perform).

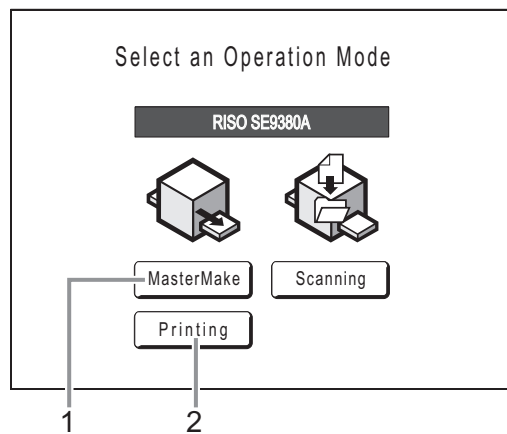

#### 1) Master Make

Scan the original set on the Glass Platen and make a master.

#### 2) Printing

Print with the master currently on the Print Drum (Cylinder). Select **[Printing]** when the master-making operation is not required further after the completion of master-making.

**B) Scan Mode**

This mode scans the original set on the Glass Platen and stores the scanned data in Storage Memory.

○ Ready to scan data

Page No.1

File Name  Owner

Directory

Basic Functions Admin.



Page(B4) Contrast Size Format

Line Auto 100% B4

Preview Book Shadow

This setting is available when the optional Document Storage Card or USB Flash Drive is attached.  
The data in Storage Memory can be edited using Editor functions.  
See "Converting Hard-copies into Stored Data (Scan Mode)" (p.188) for information on the Scan Mode.

**Note:**

-  key  
 key can be set to function as “Mode Selection” or “Loop”.  
Select “Mode Key Pattern” on the Admin. Screen.

Touch the Mode button on the Mode Screen to view the Basic Screens of various modes.

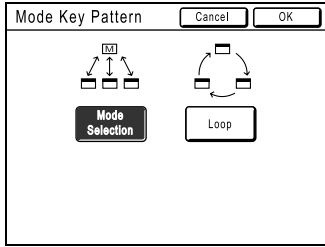

**[Mode Selection]** Pressing the  key will open the Mode Screen no matter which screen you are currently on.

**[Loop]** The screen changes as shown below when the  key is pressed.

- Normally: “Master Making BasicScreen” ↔ “PrintBasic Screen”
- When the optional Document Storage Card is installed: “Scan Basic Screen” ↔ “Master Making/Print Basic Screen”

**Tip:**

**About the Recognition Screen**

This machine is equipped with a User Management function. (p.114, p.166 “Admin.”). If “User Management” is set, the Recognition Screen is displayed. If one of the screens shown below is displayed, input the PIN Code or connect the registered USB Flash Drive. Consult your administrator for the PIN Code and the registered USB Flash Drive.

**PIN Code Input Screen**

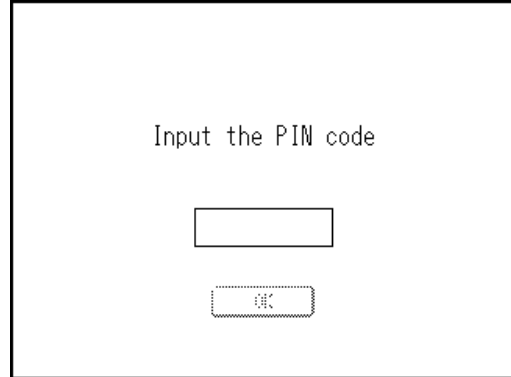

**Registered USB Flash Drive Screen**

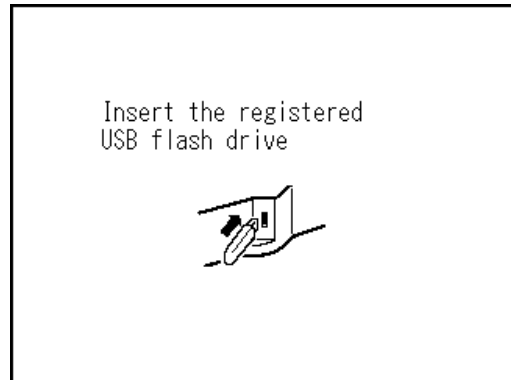



## Basic Screen Layout

The name and function of each area of all Basic Screens are described below. The display of the Basic Screen differs depending on whether you are scanning a paper document or printing from a computer.

### Printing from a Paper Document



#### 1) Message Area

Displays operation guidance and the status of the machine. Also displays program information and function icons when printing using functions such as Program, ECO mode, and Ink Saving.

#### 2) Tab Area

Touch a tab to display its screen.

#### 3) Functions Area

Displays the main functions for master-making/printing steps.

Each button shows the current setting.

Touch the relevant button to make the necessary changes.

#### 4) Direct Access Area

Up to four buttons can be selected in advance. Use this area to store most frequently-used functions.

You can make selections on the Admin. Screen.

☞ p.176

#### 5) Status Area

Displays the current status of the machine.

: Color of the currently installed Print Drum (Cylinder).

: Displays the status of data sent from a computer.

Touch to display the list of data being received.

- **[Idle]**: Ready to receive data
- **[Data-Map]**: Processing data for printing.
- **[Pause]**: Ready for output.
- **[Error]**: Error in data transmission.
- **[Blocked]**: Cannot receive data

: Touch to display **I** information (consumables information, Disposable Box Space, Print Drum (Cylinder) information, date/time, My Counter.

☞ p.203

## Printing from computer data

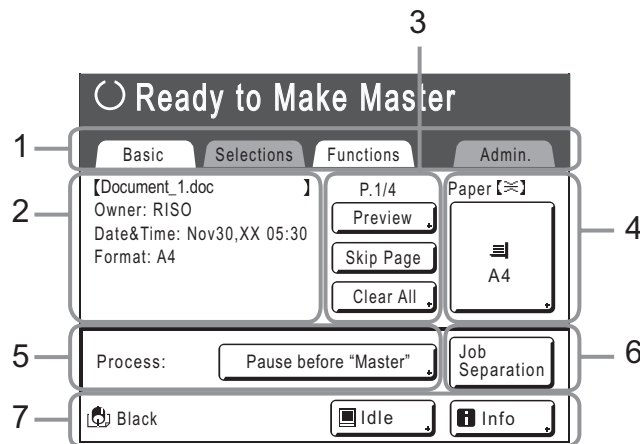

**1) Tab Area**  
 ("Selections" and "Admin." tabs are disabled)

Touch a tab to display its screen.

**2) Job Properties Area**

Properties of the current print job are displayed.  
 Refers to the computer data ready for print output.

**3) Job Operation Area**

- **[Preview]:** Displays the master making image of the page currently awaiting creation. (Available only in the Master Making Basic Screen.)
- **[Renew Page]:** Create another master when current one is damaged or compromised, without having to download data from the computer.
- **[Skip Page]:** Stops processing the current page and moves on to process the next page.
- **[Clear All]:** Stops the current process altogether.

**4) Paper Button**

**5) Process**

A printing operation can be set to stop at certain points. (overrides driver settings)

**6) Optional Device Area**

Displays when an optional device is attached.  
 Touch to activate.

**Note:**

- When no optional device is attached, "High Speed" button is displayed.

**7) Status Area**

Displays the current status of the machine.  
 This area shows the same information as that on the "Printing from a paper Document" Screen. (p.31)

## Buttons on Touch Screen

Select buttons by lightly touching with a finger.

Touch again to cancel the selection. Avoid pressing the buttons with excessive force.

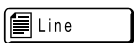

Not Selected.



Selected.



Grayed out buttons cannot be selected.

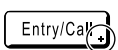

Press the button with a + on the right side to expand the options or display Setup Screens.

### Frequently Used Buttons

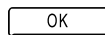

Activates/Executes a setting.

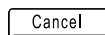

Cancels a setting.

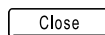

Closes the current window.



Switches between the pages.



Increases/decreases selected values (numbers, location, etc.).  
 Scrolls through the screens.

# Basic Process

## Printing from a Paper Document

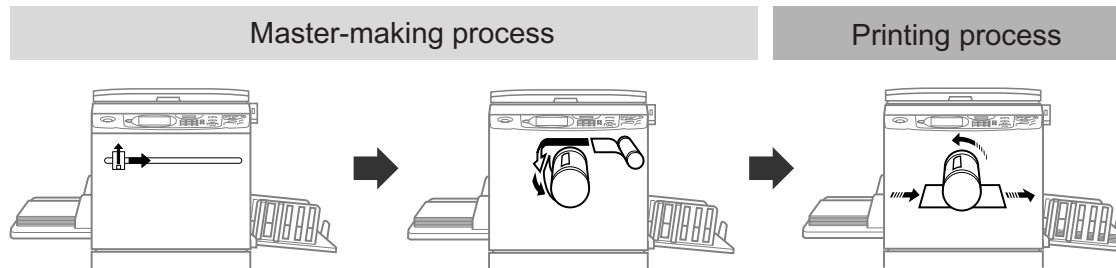

A placed original is scanned by the scanner, and a generated master is rolled around the Print Drum (Cylinder). After a while a proof copy is performed. After checking the print result, enter the number of copies to be printed and start printing.

## Printing from a Computer Data

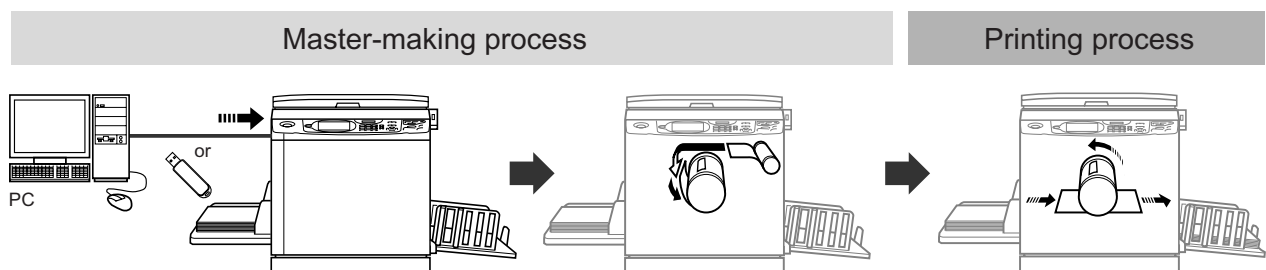

Transfer the original data created using a computer to the machine via a network or USB Flash Drive. The generated master is rolled around the Print Drum (Cylinder). After a while, a proof copy is performed. After checking the print result, enter the number of copies to be printed and start printing.

# Basic Operations

## Preparing to Print

First set up the Paper Feed Tray and Paper Receiving Tray of the machine.

### Important!:

- Do not use unsuitable paper, or mix papers of different sizes. Doing so can cause paper jams and damage the machine.  
☞ p.16

## Setting up the Paper Feed Tray and Loading The Paper

### 1 Turn the power ON.

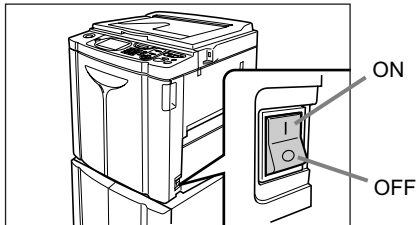

### 2 Open the Paper Feed Tray.

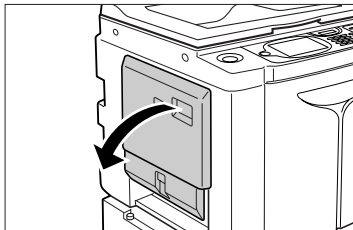

Pull the Paper Feed Tray to open it, until it comes to a rest.

### 3 Load paper.

- 1) Place paper in the printing orientation.
- 2) Slide the Feed Tray Paper Guides to fit to the sides of the paper. Then turn the right and left Feed Tray Paper Guide Levers to lock the guides.

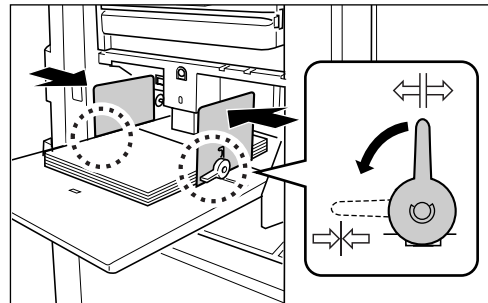

⇄ : Unlock  
⊞ : Lock

### Important!:

- Make sure that the Feed Tray Paper Guides fit tight up against the paper. Failure to do so can produce undesired results.

### Note:

- Custom size paper must be registered on the Admin. Screen before use.  
☞ p.178  
Failure to do so may create an incomplete master.

## 4 Select the paper feed pressure.

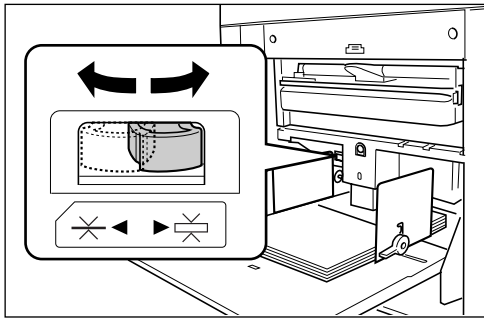

NORMAL (✕): For standard or thin paper

CARD (⊞): For thick or smooth-surface paper

### Note:

- The setting condition of the paper feed pressure is displayed at the top of the **[Paper]** button on the Basic Screen.

## 5 Check the Basic Screen.

- Select a mode.
- Touch **[MasterMake]** on the Operation Selection Screen.  
The Master Making Basic Screen appears.

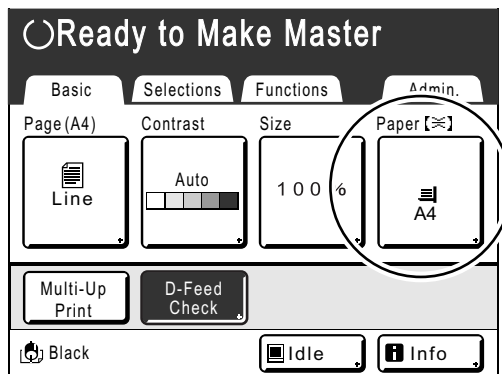

### Note:

- The paper size is automatically detected. When the size display shows “Custom” even if standard-sized paper has been set, the Feed Tray Paper Guides are not properly set against the paper.

Make sure that the Feed Tray Paper Guides fit tightly against the paper.

☞ p.65

## Adding or Replacing Paper

When you add paper or replace with paper of a different size at the time of printing, press the Feed Tray Ascent / Descent Button to lower the Paper Feed Tray.

- The Paper Feed Tray is lowered while you press and hold the button, and when you release the button, the tray stops at that position.
- When the tray runs out of paper or you remove all papers, the tray is automatically lowered to the bottom.
- After paper has been replenished, the Paper Feed Tray automatically rises when you press the  Key on the Control Panel.

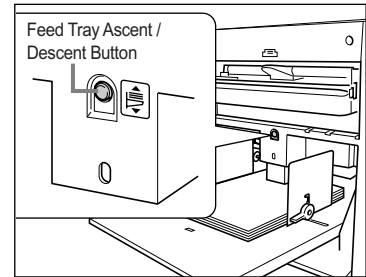

### Important!:

- When changing to a different paper size, remember to readjust the Receiving Tray Paper Guides and Paper Stopper.
- When changing to a different quality paper, remember to adjust the Paper Feed Pressure Adjustment Lever.

### Note:

- When the Paper Feed Tray has been lowered to the bottom, if you press this button after paper has been replenished, the Paper Feed Tray rises.

## Closing the Paper Feed Tray

Before closing the Paper Feed Tray, remove the paper and widen the Feed Tray Paper Guides to the limits. Then close the Paper Feed Tray.

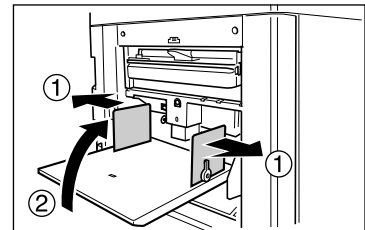

## Setting up the Paper Receiving Tray

### 1 Open the Paper Receiving Tray.

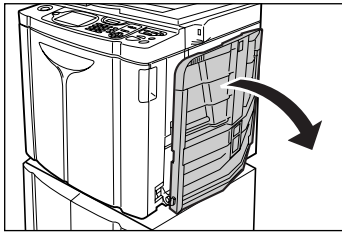

Pull the Paper Receiving Tray down until it comes to a rest.

### 2 Position the Receiving Tray Paper Guides.

- 1) Raise the Receiving Tray Paper Guides.
- 2) Hold their lower part and slide them to fit to the paper width.

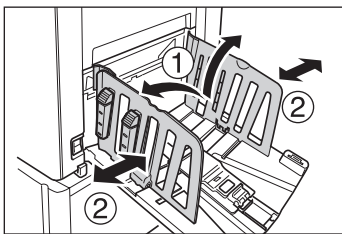

#### Important!:

- For thick paper such as drawing paper, position the Receiving Tray Paper Guides a little wider than the actual paper width.

### 3 Set the Paper Stopper.

- 1) Raise the Paper Stopper.
- 2) Slide to fit the length of the paper.

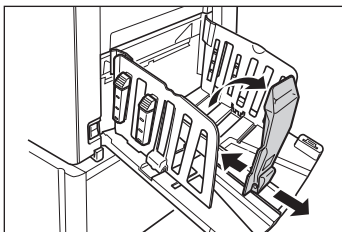

### 4 Adjust the Paper Arrangers.

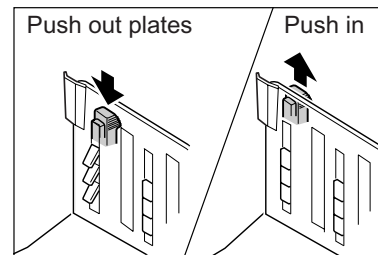

Alignment of paper is affected by sizes and strength of paper. Adjust the Paper Arrangers so that printed paper is aligned.

Press the Paper Arranger to push the plates out, pull the plates up to pull them in.

#### ◆ For plain paper

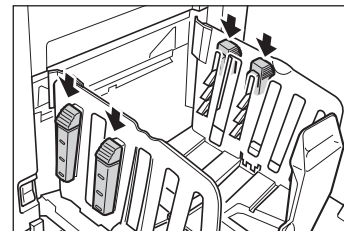

Press to open all four Paper Arrangers.

#### ◆ For plain paper with images lopsided on page

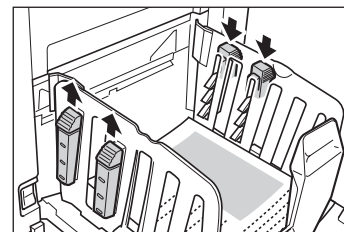

Press to open the two Paper Arrangers on the more heavily printed side.

#### ◆ For thick paper

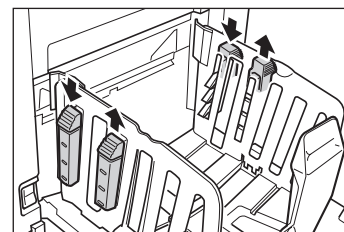

Press to open the two Paper Arrangers (right and left) closer to the machine.

## Closing the Paper Receiving Tray

Remove all the printed copies and follow the steps below.

- 1) Slide the Paper Stopper to the edge of the Paper Receiving Tray and fold in.

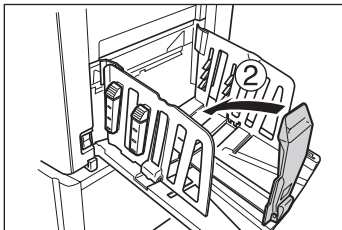
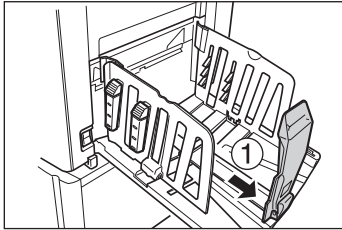

- 2) Pull up the Paper Arrangers, slide the Receiving Tray Paper Guides to the left and right as far as they will move and fold in.

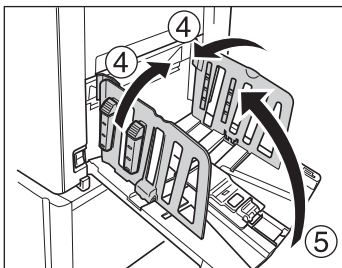
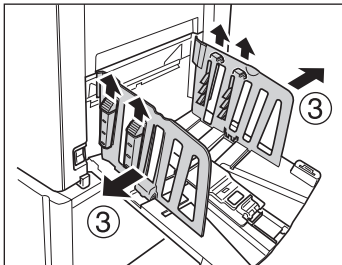

- 3) Close the Paper Receiving Tray.



## Setting up the Auto-control Stacking Tray (Optional)

### 1 Open the Auto-control Stacking Tray.

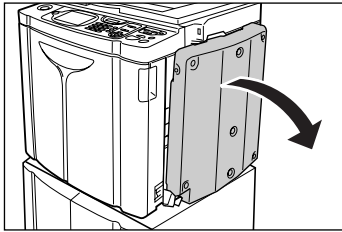

Pull the Auto-control Stacking Tray down until it comes to a rest.

### 2 Raise the Receiving Tray Paper Guides.

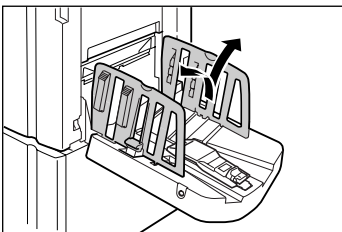

### 3 Raise the Paper Stopper.

The Receiving Tray Paper Guides/Stopper positions are automatically adjusted for paper size used.

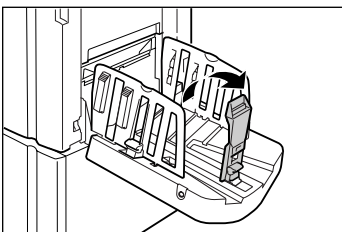

#### Note:

- The Receiving Tray Paper Guides/Stopper positions can be adjusted on the Touch Panel. [p.112](#)
- Pressing the Receiving Tray Paper Guides' Opening Button during printing moves the Receiving Tray Paper Guides for about 1 mm ( $\frac{3}{64}$ " ) outward each time.

### 4 Adjust the Paper Arrangers.

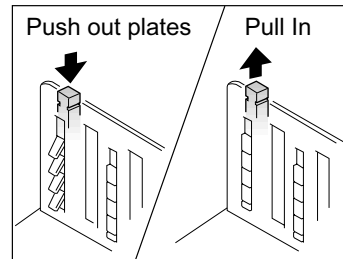

Alignment of paper is affected by sizes and strength of paper. Adjust the Paper Arrangers so that printed paper is aligned.

Press the Paper Arranger to push the plates out, pull up to pull them in.

#### ◆ For plain paper

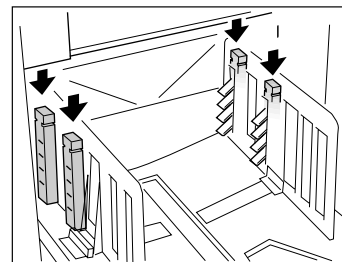

Press to open all of the four Paper Arrangers.

#### ◆ For plain paper with images lopsided on page

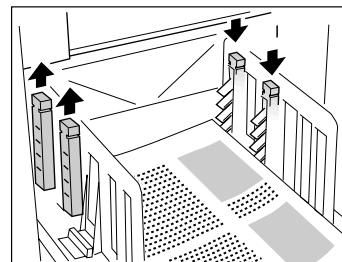

Press to open the two Paper Arrangers on the more heavily printed side.

◆ For thick paper

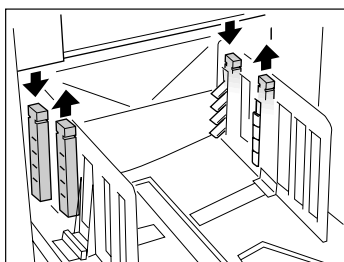

Press to open the two Paper Arrangers (right and left) closer to the machine.

### Closing the Auto-control Stacking Tray

Follow the steps below to close the Auto-control Stacking Tray.

**Important!:**

- If any printed copies remain on the Auto-control Stacking Tray, press the Receiving Tray Paper Guides' Opening Button to remove them.

- 1) Make sure there is no paper on the Auto-control Stacking Tray, then press the Receiving Tray Paper Guides' Opening Button.

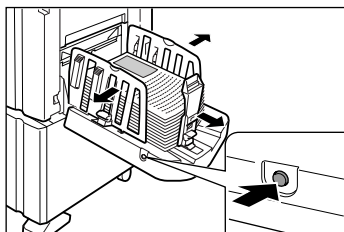

- 2) Fold in the Paper Stopper.
- 3) Pull up the Paper Arrangers.

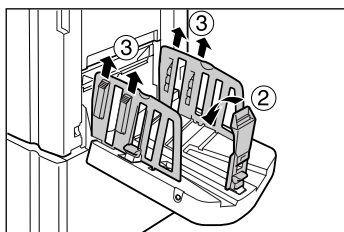

- 4) Fold in the Receiving Tray Paper Guides.

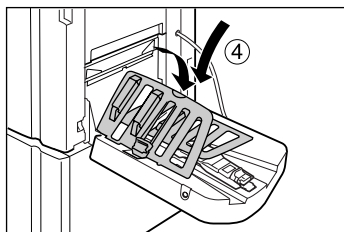

- 5) Close the Auto-control Stacking Tray.

# Placing the original

## When placing on the Glass Platen

Open the Platen Cover and place the original face-down. Align the center of the original with the mark on the left-hand side of the glass. After placing the original, slowly close the Platen Cover.

Magazines, books, scrap books, etc. should be placed on the Glass Platen.

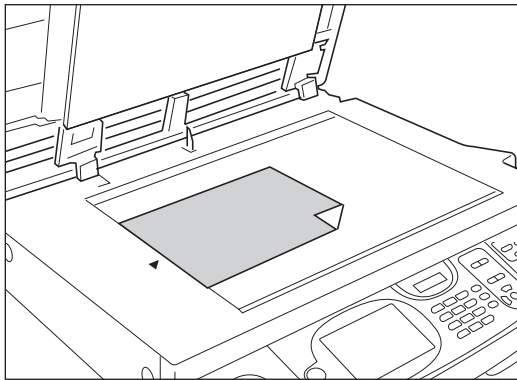

### Note:

- If the Gauge Cover is installed, place the original underneath.

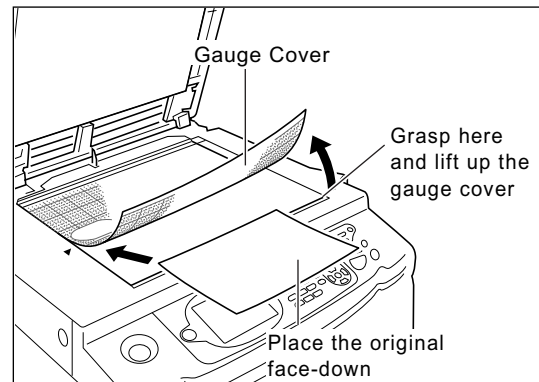

## When placing in the ADF unit (Option)

Use the ADF unit if you are printing multiple originals in succession.

Place originals so that the one to be scanned first is on the top. Afterwards, align the ADF Original Guides with the page width and set originals fully to the rear of the ADF.

### Important!:

- If the original is smaller than the paper size that can be set in the ADF unit, place the original on the Glass Platen.
- Do not place multiple originals of differing sizes or otherwise unsuitable originals into the ADF unit. It might cause paper jams and damage the machine.  
☞ p.18
- Once the originals are placed into the ADF unit, "Auto Process" setting is turned ON. Press the  key to turn it OFF. Default "Auto Process" setting for the ADF unit can be changed on the Admin. Screen.  
☞ p.167, ☞ p.168

### Note:

- Up to 50 sheets of 80 g/m<sup>2</sup> (21-lb bond) paper can be placed in the ADF unit.
- To print a proof copy after each master-making process, select **[ADF Semi-Auto]**.  
☞ p.155

## When using the ADF AF-VI:II

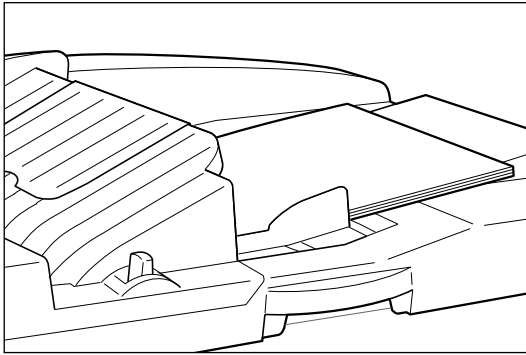

Set the original face-down.

### Important!:

- The placeable original size of 100 mm × 148 mm (3<sup>15</sup>/<sub>16</sub>" × 5<sup>13</sup>/<sub>16</sub>" ) and above.

## When using the ADF DX-1

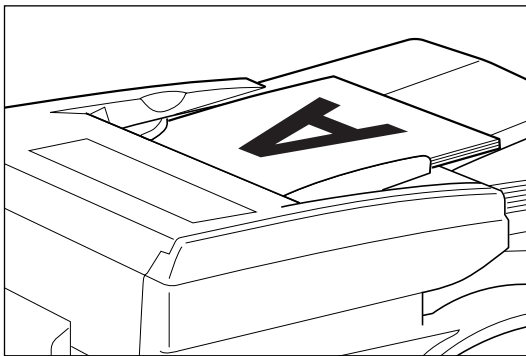

Set the original face-up.

The side of the original that is read can be specified. For details about the settings, refer to [p.156](#).

### Important!:

- The placeable original size of 105 mm × 128 mm (4<sup>1</sup>/<sub>8</sub>" × 5<sup>1</sup>/<sub>32</sub>" ) and above.

### Tip:

#### Setting Direction (direction of text on the original)

The original setting direction is decided by the number of pages set when using "Multi-Up Print" and "Layout" functions.

Set the original according to the direction of text on the original seen from the touch panel side.

### Align Top

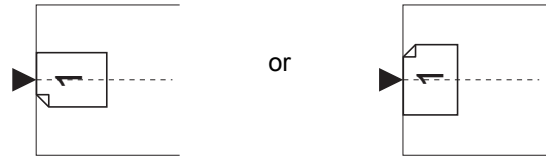

### Align Side

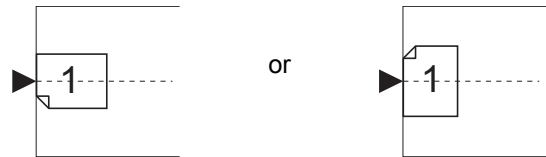



# Printing from a Paper Document or Book

The steps for scanning an original for printing is explained below.

## 1 Make sure the machine is ON.

Check the Control Panel.

### Note:

- When the power is OFF, both the Display and the  key are off. Turn the power ON.
- If the  key is lit, the machine is in Energy Saving mode. Press the  key to cancel Energy Saving mode.

## 2 Check for printing paper.

Make sure the paper is loaded.

To load or to change the paper, see the following page:  
[p.37](#)

After replacing with paper of a different size, adjust the position of the Receiving Tray Paper Guides and Paper Stopper.

[p.36](#)

## 3 Check the Display.

### ◆ When the Recognition Screen is displayed.

Follow the message on the screen.

For details, see [p.114](#).

The initial screen will be displayed after the user has been identified.

### ◆ When the initial screen is displayed

Proceed to step 4.

The initial screen differs depending on the setting of “Display Priority” of “Admin.”.

## 4 Touch [MasterMake] on the Operation Selection Screen.

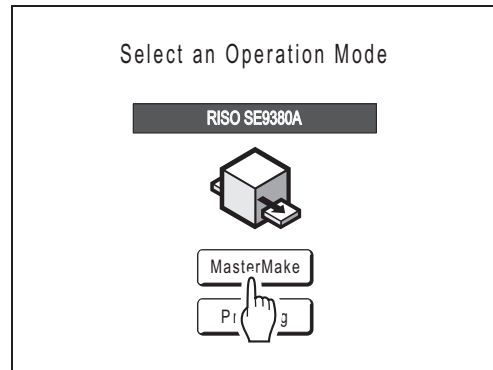

The Master Making Basic Screen appears.

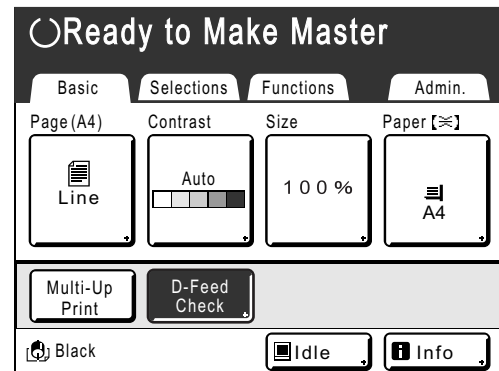

### Note:

- When you see **[Data-Map]** in the Status Area, the machine is busy receiving electronic data from the computer. Please wait a moment.

## 5 Place the original.

Place the original on the Glass Platen or in the optional ADF (Auto Document Feeder) unit. To place the original, see [p.41](#).

## 6 Configure print functions.

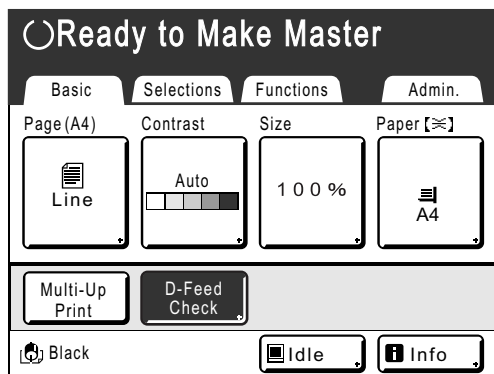

In the Master Making Basic Screen, select functions as needed.

### Note:

The following selections are available:

- Auto Process (☞ p.66)
- Image (Image Processing mode) (☞ p.58)
- Scanning Contrast (☞ p.60)
- Size (Enlargement/Reduction) (☞ p.61)
- Paper (☞ p.65)
- Program (☞ p.129)
- Job Memory (☞ p.140)
- Dot Process (☞ p.67)
- Contrast Adj (☞ p.68)
- Tone Curve (☞ p.69)
- Ink Saving (☞ p.70)
- 2 Up/Multi-Up Print (☞ p.71)
- Layout (☞ p.80)
- Book Shadow (☞ p.84)
- Top Margin (☞ p.87)
- Binding margin (☞ p.88)
- Preview (☞ p.92)
- D-Feed Check (☞ p.103)
- Interval (☞ p.104)
- Jump Wing Control (☞ p.106)
- Receive Tray<sup>\*1</sup> (☞ p.112)
- Special Paper Ctrl (☞ p.105)
- Max. Scan (☞ p.90)
- Output reversal (☞ p.153)
- ADF Semi-Auto<sup>\*3</sup> (☞ p.155)  
This setting is available when the ADF unit (option) is installed.
- Idling Action (☞ p.149)
- Renew Page (☞ p.150)
- Scanning Side -ADF<sup>\*2</sup> (☞ p.156)  
This setting is available when the Auto Document Feeder DX-1 (option) is installed.

- Overlay<sup>\*5</sup> (☞ p.197)  
This setting is available when the Document Storage Card (option) is attached.
- Job Separation<sup>\*4</sup>  
This setting is available when the Job Separator (option) is installed.
- Storage Memory<sup>\*5</sup> (☞ p.193)

- \*1 This setting is available only when the Auto-control Stacking Tray (optional) is installed.
- \*2 This setting is available only when the Auto Document Feeder DX-1 (optional) is installed.
- \*3 This setting is available when the optional ADF unit is installed.
- \*4 This setting is available when the optional Job Separator is installed.
- \*5 This setting is available only when a memory card (optional) is attached.

## 7 Check the Paper Receiving Tray.

Adjust the position of the Receiving Tray Paper Guides and Paper Stopper to match the size of the paper used.

## 8 Press the key.

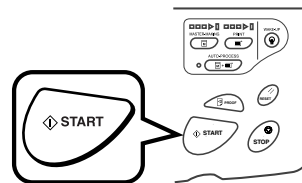

Starts scanning the original. A master is made once the scanning is completed, and a proof copy will be printed.

### Note:

- When “Auto Process” is selected, the process will be different.  
☞ p.66
- You can change the settings of “Auto Idling”.  
☞ p.171

## 9 Check the proof copy result.

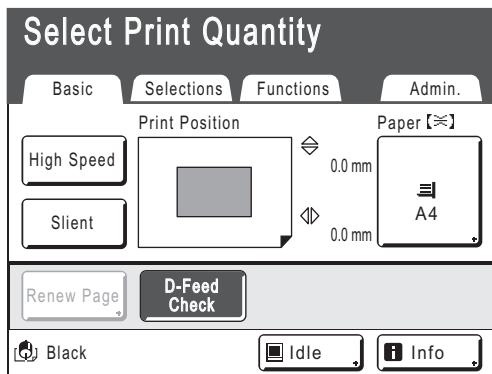

When a proof copy is printed, the Print Basic Screen will be displayed automatically. Check the proof copy; e.g., print position and density.

If necessary, change the print position and density.

- Print Position (☞ p.100)
- Print Density (☞ p.99)
- Interval (☞ p.104)
- Jump Wing Control (☞ p.105)

After adjustment, press the  key to print a proof copy.

### Important!:

- When the machine has not been used for a long period of time, the print quality may suffer due to dry Ink on the Print Drum (Cylinder). Press the  key to print proof copies several times.

### Note:

- You can also adjust the print position, the density, and the speed while the print process is in progress.

## 10 Enter the number of copies using the Print Quantity Keys.

The specified number is displayed on the Print Quantity Display.

### Note:

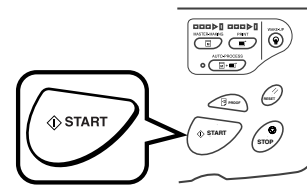

- To change the number, press the  key, then re-enter the correct number.

## 11 Press the key.



The specified number of copies will be printed.

### Note:

- Press the  key to interrupt printing operation currently underway.
- When printing from a computer, if the machine is inactive for a certain period of time, it determines that the current job is completed, even if the actual printing is still under way. If another person accidentally initiates another job from the computer, this will cause a new master to be made, discarding the current one. To prevent this, you may set a "Reserve Period". We recommend that you activate the "Reservation" setting when printing leaflets, etc. to prevent interruption. ☞ p.148
- Easily restore the current settings by saving them into memory. Saved settings can be retrieved even when the  key is pressed, or after turning the power off. ☞ p.140

## 12 Press the key when print job is complete.

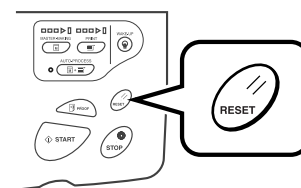

The setting returns to its default value.

### Note:

- After printing is completed, the master remains on the Print Drum (Cylinder). To protect confidential documents from unauthorized duplication, use the "Confidential" feature to discard the master after printing. ☞ p.147
- Even if you do not press the  key, with the passage of a certain amount of time (factory default settings: 5 minutes), the settings will be automatically reset. ☞ p.140

### 13 Remove the printed paper.

Open the Receiving Tray Paper Guides and remove the paper.

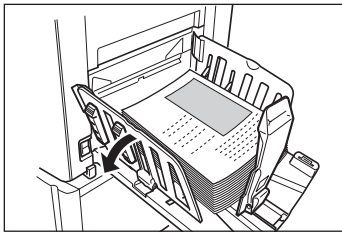

For the machine equipped with the Auto-control Stacking Tray, press the Receiving Tray Paper Guides' Opening Button and remove the paper.

**Tip:**

**Auto Idling**

When "Auto Idling" is set to ON, idling operations may be activated when master-making process is initiated.

Factory default is set to idle automatically at the beginning of the master-making when the machine is inactive for over 12 hours.

To toggle "Auto Idling" ON/OFF, or to modify the number of hours before activating next idling, go to the Admin. Screen.

☞ p.171

Idling can also be manually initiated when making a master.

☞ p.149

**Tip:**

**Operations on the Recognition Screen**

When "User Management" is set by the administrator, the users will be asked to identify themselves ("User identification access": if he/she is registered or not) during operations.

The user identification procedures will differ according to the Recognition and Identification System decided by the administrator.

**Note:**

- A PIN Code and USB Flash Drive are used in the Recognition and Identification System. Contact your administrator for the PIN Code and the USB Flash Drive you have to use.

**When the PIN Code Input Screen is displayed**

Enter the PIN Code using the Print Quantity Keys and touch [OK].

The initial screen will be displayed after the user has been identified.

**Note:**

- If an incorrect PIN Code is entered, an error message will be displayed. Re-enter the correct PIN Code.

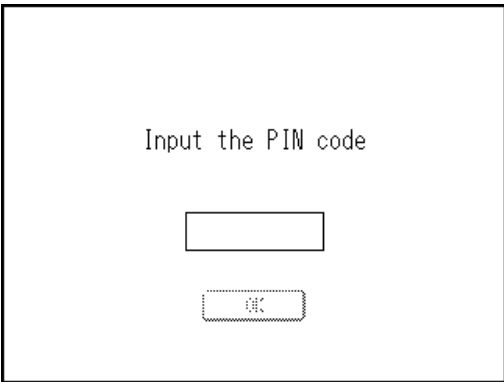

**When registered USB Flash Drive Screen is displayed**

Connect the registered USB Flash Drive to the USB slot.

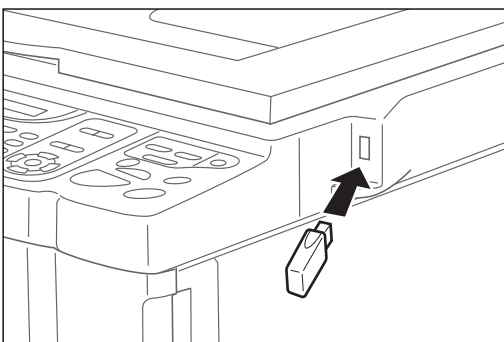
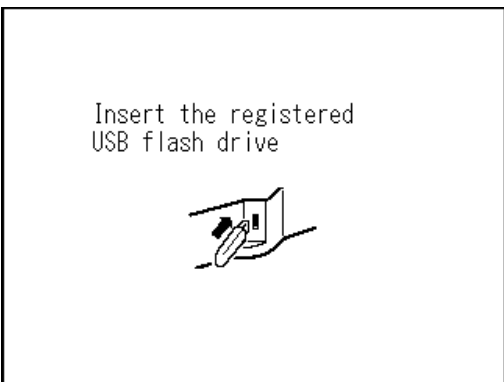

The initial screen will be displayed after the user has been identified.



**Note:**

- If an unregistered or unusable USB Flash Drive is connected to the machine, an error message will be displayed. Connect a registered USB Flash Drive.

**Important!:**

- After printing is completed, press the  key to log out before leaving the machine. If you do not log out, the logged-in state will remain until "Auto Clear" is activated. During this time, anyone can use the machine (as you) without logging in.

 p.170

# Printing from a Computer Data

## [Direct Print] [USB Job List]

This machine can directly print the original created on the computer by connecting the computer and machine by a cable. The data will be digitally processed into a master, thus achieving higher quality prints than the master-making of scanned originals.

Furthermore, a USB slot for connecting a USB Flash Drive is supplied with this machine so that you can print by connecting a USB Flash Drive that stores the data of originals to the machine even if the computer and machine are not connected by a cable.

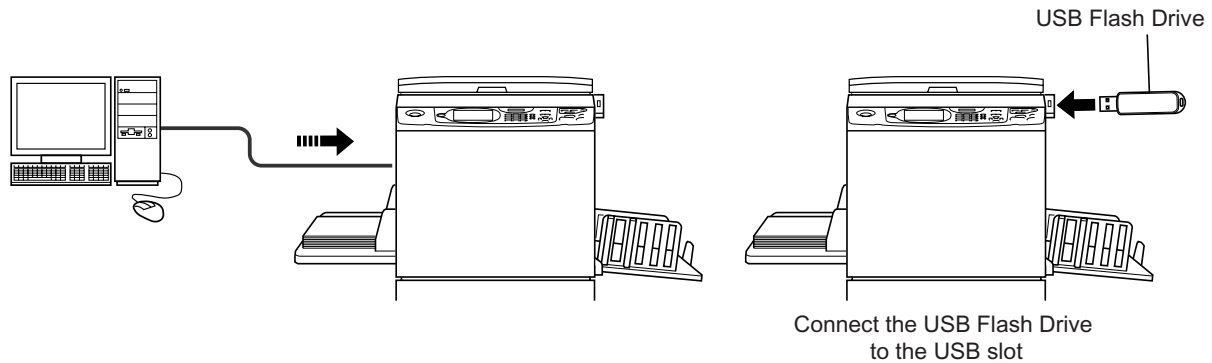

**Note:**

- First, install a proper printer driver on your computer. See the RISO Printer Driver User's Guide for installation details.
- Document data created on your PC can be stored in the optional Document Storage Card attached to the machine.
- This manual provides only a summary of functions available when printing from a computer. See RISO Printer Driver User's Guide for further details about sending data and other settings.

## Auto Process and Stop Timing

Auto Process is a combined automated steps of receiving data from the computer, making a master, and printing. To activate "Process", open the printer properties dialog box on the computer and select "Auto-process". (A proof copy will not be printed.)

During each process, in order to adjust settings or to change paper, you can stop the operation.

To temporarily halt an operation during the creation of a master or during print process, select one of the following three options for "Process" in the printer properties dialog box.

- Pause before "Master"  
Halts the operation before master-making:  
To change settings, to change paper and to change Print Drum (Cylinder)
- Pause before "Print"  
Halts the operation before printing:  
To print proof, to adjust Ink density, to adjust positioning and to change printing speed
- Auto-process "OFF"  
Stops twice; before making a master, and again before printing.

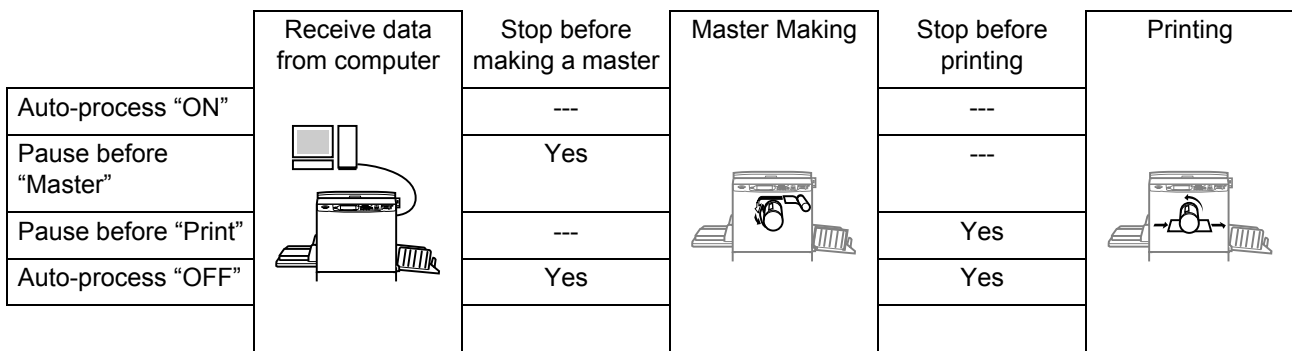

**Note:**

- The timing for stopping printing can also be changed from the display of the machine.  
p.57

## Printing Computer Data [Direct Print]

The computer and printer must be connected by a cable.

**Note:**

- When “User Management” is set by the administrator, the users will be asked to identify themselves during operations.  
 ↗ p.46

### 1 Make sure the machine is ON.

Check the Control Panel.

**Note:**

- When the power is OFF, both the Display and the  key are off. Turn the power ON.  
 ↗ p.34
- The machine automatically wakes up from Energy Saving mode when data is sent from a computer, and it starts processing the data.

### 2 Check for printing paper.

Make sure the paper is loaded.

To load or to change the paper, see the following page.

↗ p.37

After replacing with paper of a different size, adjust the position of the Receiving Tray Paper Guides and Paper Stopper.

↗ p.36

### 3 Set printing options from your computer screen.

Use the printer driver.

**Important!:**

- Make sure to remove the checkmark from the “Collate” option in the Print dialog box.

**Note:**

- If you are using RISO Network Card, you can check the machine status (power ON/OFF, paper settings, etc.) remotely from your computer monitor.

### 4 Click [OK] on the print dialog box.

Data is sent from the computer.

When the machine receives data, a print job automatically starts in accordance with the printer driver settings.

Skip to step 6 if you are printing in Full Auto.

### 5 Perform printing from the control panel.

The displayed screen and operation procedure differ depending on the “Auto-Process” (Basic tab) setting of the printer driver.

◆ **Printing with Pause before “Master”**

The Master Making Basic Screen in step 2) is paused depending on the use of the machine or Admin. settings. In this case, press the  key.

1) Touch [Pause].

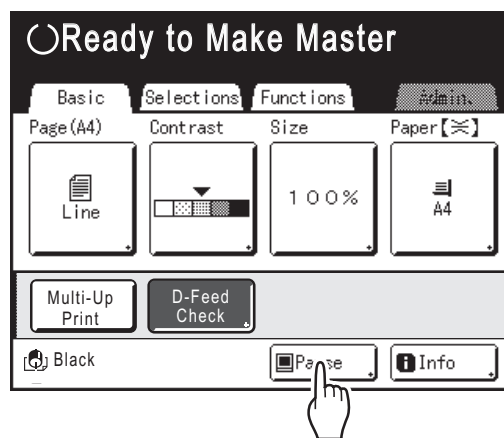

The Job List Screen is displayed.

- 2) Touch **[Output]**.  
 If you want to operate the ID print, touch **[ID Print Job]**.  
 ☞ p.52  
 ☞ p.193

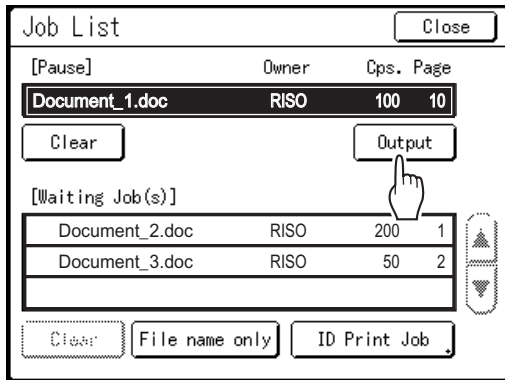

The following screen appears.

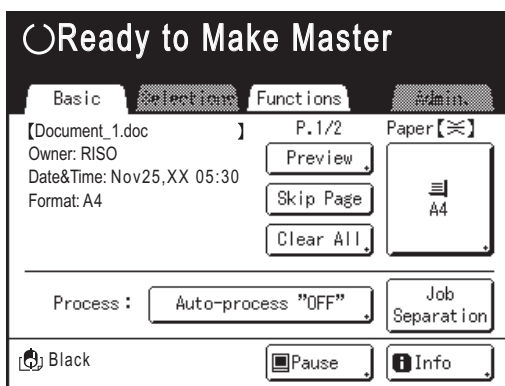

- 3) Press the **[START]** key.  
 After making a master, start printing.

#### ◆ Printing with Pause before “Print”

A master is made after receiving the data. The machine stops after printing a proof copy.

- 1) Check the proof copy and adjust the settings as needed.
- 2) Press the **[START]** key.  
 Printing starts.

#### ◆ Printing with Auto-process “OFF”

- 1) Follow steps 1 to 3 in “Pause before “Master””.  
 Stop after making a master and printing a proof copy.
- 2) Check the proof copy and adjust the settings as needed.
- 3) Press the **[START]** key.  
 Printing starts.

#### Note:

- If the data contains multiple pages, repeat the same steps for each page.
- Entering the number of copies from the Print Quantity Keys will override the number specified in the Print dialog box.
- For “ID Print”, printing starts with specified Auto Process mode after recognition.
- To manually stop a job during master-making or printing operation, press the **[STOP]** key. In master-making process, the machine will stop after the master is made. In printing process, the machine will stop printing.  
 Press the **[START]** key to resume the job.

## 6 Remove the printed paper.

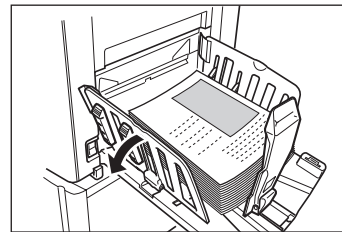

Open the Receiving Tray Paper Guides and remove the paper.

#### Note:

- After printing is completed, the master remains on the Print Drum (Cylinder). To protect confidential documents from unauthorized duplication, use the Confidential feature to discard the master after printing.  
 ☞ p.147

**Tip:**  
**Job List Screen**

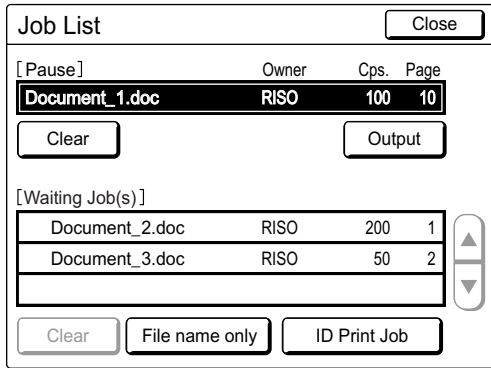

Once the data is received, touch on the Basic Screen to review current Job List. From the Job List Screen, you can initiate output for jobs pausing for output, or cancel jobs that are “Paused/Data-Mapping/Waiting”.

**Tip:**  
**ID Print**

The data sent from the printer driver as the “ID Print” is retrieved from the ID Print Job Screen and printed.

Touch **[ID Print Job]** to display the Recognition Screen, and follow the message on the screen. The timing of the Recognition Screen differs depending on the “User Management” settings done by the administrator. [p.171](#)

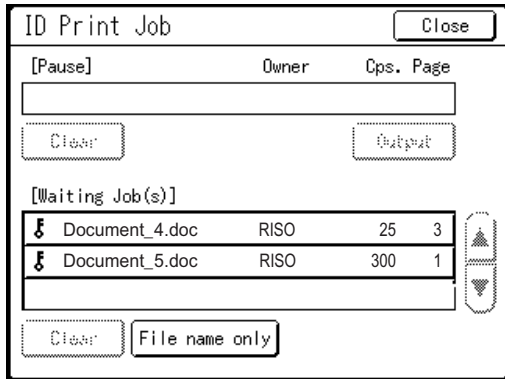

**Note:**

- To set the “ID Print” in the printer driver, a user registration number (ID) is required (one or two digits). Contact your administrator for the PIN Code or registered USB Flash Drive, and the user registration number (ID).

## Printing USB Data [USB Job List]

Even if the computer and machine are not connected by cable, you can print original data via a USB Flash Drive. It is useful when the computer and printer are placed in different places or printing with SE 9 Series in outside location.

### Note:

- When “User Management” is set by the administrator, the users will be asked to identify themselves during operations. For details, see [p.114](#).

### 1 Connect the USB Flash Drive to the computer.

#### Note:

- If the Recognition and Identification System (“Recognized by”) is set to “USB Flash Drive” in the “User Management”, it is also convenient for you to use the registered USB Flash Drive to output the data.

### 2 Set printing options from your computer screen.

Use the USB flash-via-Printer Driver.

#### Note:

- Make sure to remove the checkmark from the “Collate” option in the Print dialog box.



### 3 Click [OK] in the print dialog box.

The data created on the computer is stored in the USB Flash Drive.

### 4 Make sure the machine is ON.

Check the Control Panel.

#### Note:

- When the power is OFF, both the Display and the  key are off. Turn the power ON. [p.34](#)
- If the  key is lit, the machine is in the Energy Saving mode. Press the  key to cancel the Energy Saving mode.

### 5 Check for printing paper.

Make sure paper is loaded.

To load or to change the loaded paper, see following page.

[p.37](#)

After replacing with paper of a different size, adjust the position of the Receiving Tray Paper Guides and Paper Stopper.

[p.36](#)

### 6 Connect the USB Flash Drive that contains the original data to print to the USB slot.

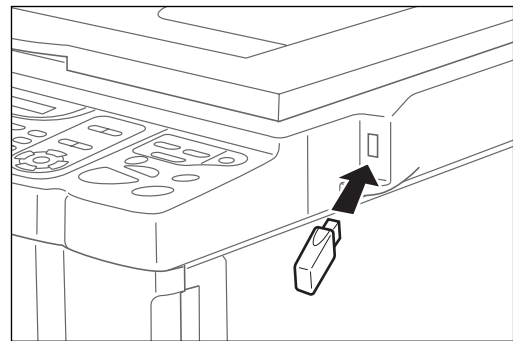

#### Important!:

- While processing the data, do not remove the USB Flash Drive. This will cause data to disappear and the USB to malfunction.

#### Note:

- If the “USB print (Auto Process)” has been set as the output method (Basic tab), connecting the USB Flash Drive starts master-making/printing process as per the “Process” setting. For detailed settings, refer to the “RISO Printer Driver User’s Guide”.

### 7 Touch [Functions] on the Master Making Basic Screen.

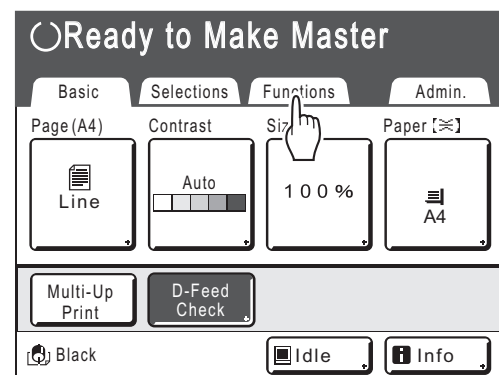

## 8 Touch [USB Job List].

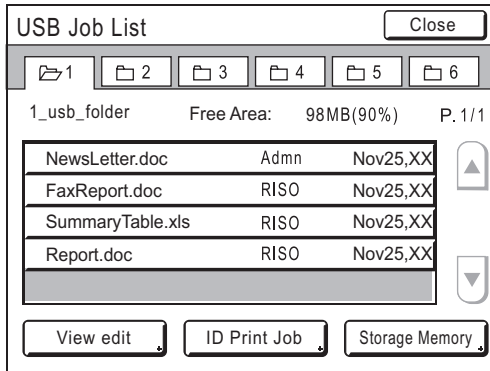
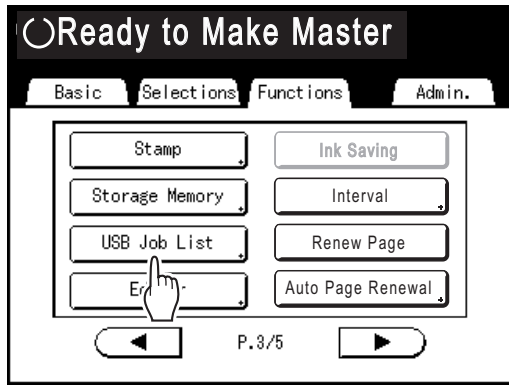



The USB Job List Screen (with “Non-ID Print”) is displayed.  
(The “ID Print Job” button is displayed on the screen.)

## 9 Touch the data to print.

The “USB Job List” Retrieve Screen is displayed. If you are selecting data stored in a different folder, touch “Cancel”, and touch that folder’s tab.

### Note:

- To retrieve the ID print, touch **[ID Print Job]**.
- When “Management Level” is set to “Low/Admin tab only” in the “User Management”, **[ID Print Job]** will not be displayed.
- If the stored data is not shown on the screen, touch  or  to display it.

## 10 Confirm the retrieved data.

Use the thumbnail to check whether the specified data is the desired data or not.

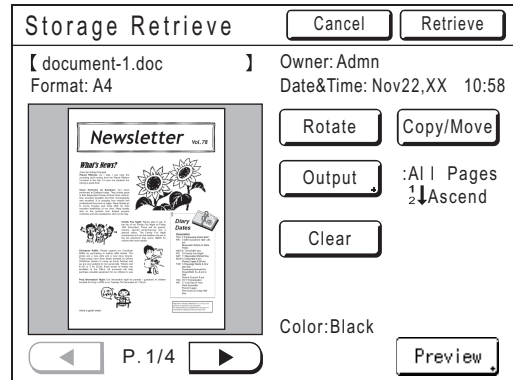

From the “USB Job List” Retrieve Screen, you can confirm retrieved data and specify output settings. See [p.196](#) for operational details.

## 11 Touch [Retrieve].

The data is retrieved and the following screen appears:

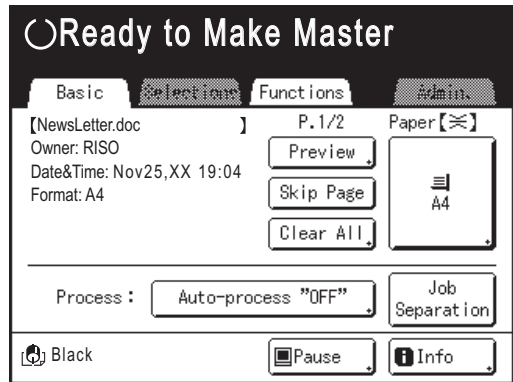

### Note:

- You can change the output directions and stop timing settings on the Master Making Basic Screen.  
For details, see [p.26](#) and [p.55](#).

## 12 Enter the number of copies using the Print Quantity Keys.

The entered number is displayed on the Print Quantity Display.

## 13 Press the key.

Data is printed.

After this, follow the same operations for paper documents.



## Changing Output Directions

Output can be controlled from the Master Making/Print Basic Screens.

### ◆ Master Making Basic Screen

- **[Preview]**

You can check the master making image of the page currently awaiting creation.

**Note:**

- In “Preview”, all received original data is displayed as a master making image. Portions outside the print area do not actually print.
- **[Skip Page]**  
Cancels a pending page, and starts processing the next page. Use this button when current file has extra, unwanted pages.
- **[Clear All]**  
Deletes all jobs currently in the queue. Use this button to delete a job sent by a mistake, or pending jobs no longer needed.

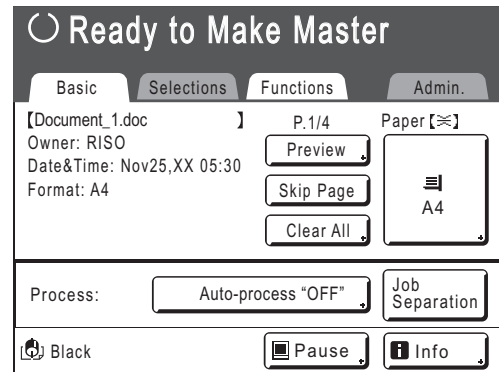

### ◆ Print Basic Screen

- **[Renew Page]:**

You can recreate another master when the current one is damaged without having to receive original data from the computer.



**Note:**

- If multiple pages exist, only the last page will be processed.
- “Rotate” can also be specified.
- The confirmation screen for each respective button appears when touched. Touch **[OK]** to implement the instructions.

### Important!:

- **[Skip Page]** and **[Clear All]** are disabled during master-making or printing processes. Press the  key to modify directions while master-making or printing is in progress. (In master-making process, the operation will stop after the master is made. In print process, the print job is halted.)

**Note:**

- Pressing either the  key or the  key while waiting for a command (under Ready to Make Master/Ready to Print screens) will delete the pending job.

### When selecting [Skip Page]

1 Touch [Skip Page].

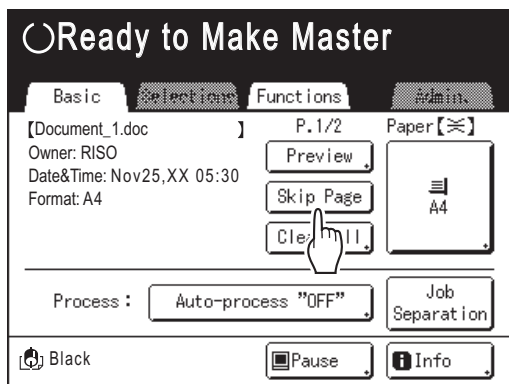

2 Touch [OK].

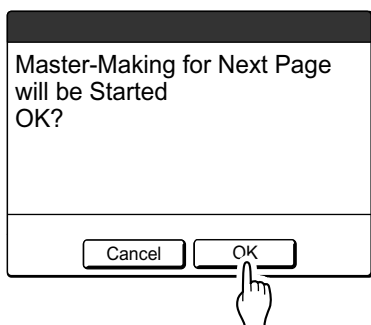

Stops processing current page and moves on to process the next page.

### When selecting [Clear All]

1 Touch [Clear All].

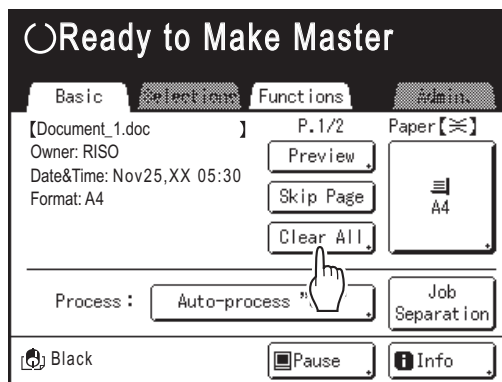

2 Touch [OK].

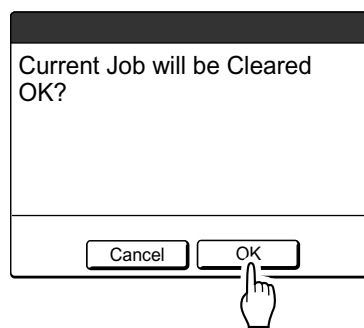

Clears current job.  
Starts processing next data in queue.

## Changing Stop Timing

Stop timing as set on the printer driver takes priority by default. However, the settings can be changed on the machine while the machine is halted.

### Note:

- If [Auto-process] is set to "ON" in the Printing Property of the printer driver, press the  key to stop the operation and make the changes.

### 1 Touch the "Process" function button.

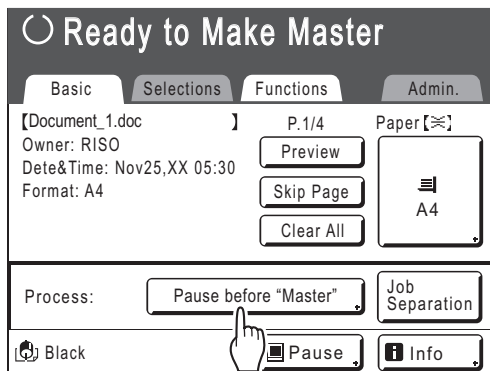

The Process Screen appears.

### 2 Select the desired function.

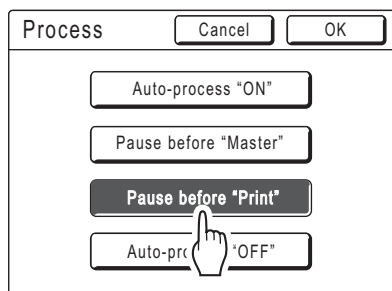

- **[Auto-process "ON"]:** Makes a master then automatically prints.
- **[Pause before "Master"]:** The operation stops before making a master.
- **[Pause before "Print"]:** After a master is made and a proof copy is printed, the operation stops.
- **[Auto-process "OFF"]:** Stops before making a master, and again stops before printing.

### Note:

- See [p.50](#) for details regarding operations after each stop.

### 3 Touch [OK].

Returns to Basic Screen. Auto Print setting is updated.

# Functions for Master-Making

## Selecting Image Processing Mode [Image]

In order to make a master best suited for the original document, select an appropriate mode depending on whether original contains only text (Line), photo, or both of them.

**Note:**

- Default Image Processing mode can be set on the Admin. Screen.  
 ↪ p.167

### 1 Touch [Page] on the Master Making Basic Screen.

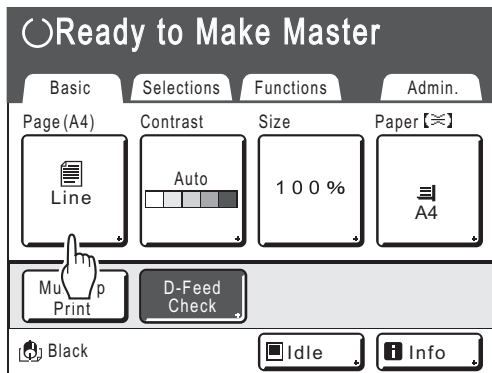

### 2 Select the appropriate Image Processing mode for the original.

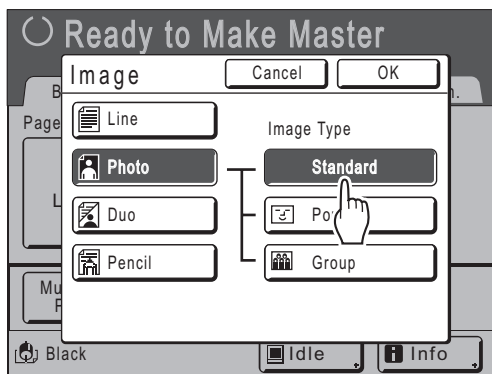

- **[Line]:** Only text contained; e.g., text document, newspaper
- **[Photo]:** Only photos contained
- **[Duo]:** Both text and photos contained
- **[Pencil]:** pencil drawings or lightly printed documents

Touch **[Photo]**, **[Duo]**, or **[Pencil]** to select more detailed settings.

Image (Detailed settings)	Description
<b>[Photo]</b>	
Standard	Select this setting for photos other than <b>[Portrait]</b> or <b>[Group]</b> .
Portrait	Select this setting for pictures of one or two individuals from the bust up. This type of image processing is particularly good for printing photos of faces.
Group	Select this setting for group photos that are over-exposed. This process is effective for restoring facial features that have got washed out because of flash. The Group setting is not for photos with faces that are overly dark. It may be more effective to select <b>[Standard]</b> for such photos.
<b>[Duo]</b>	
Line	Select this setting for printing small text clearly.
Photo	Select this setting for printing more clearly (brightly).
Shadow off	Select this setting for clearing the background color of the dark-colored originals (such as newspapers). <b>[Shadow off]</b> is selectable aside from <b>[Line]</b> and <b>[Photo]</b> .
<b>[Pencil]</b>	
Darker	Select this setting for printing faint originals clearly.
Lighter	Select this setting for printing cut-and-pasted pencil drawings with shadows.

### 3 Touch [OK].

Returns to the Master Making Basic Screen.  
Image Processing mode is updated.

**Note:**

- Some functions are not available in certain Image Processing mode settings.

	Line	Photo	Duo	Pencil
Dot Process	—	✓	✓	—
Contrast (Auto)	✓	—	—	—
Contrast (1-5)	✓	✓	✓	✓
Contrast Adj	—	✓	—	—
Tone Curve	—	✓	✓	✓

✓ : available    — : not available

- In **[Line]** mode, when **[Contrast]** is set to **[Auto]**, the background color of the original is automatically deleted.  
☞ p.60

# Selecting Scanning Contrast for the Original [Contrast]

Scanning contrast can be adjusted to accommodate background color or Ink density of the original. Specify by selecting Auto or numeric levels (1-5). In the Auto mode, "Contrast" is automatically adjusted to the background color of the original for printing.

**Important!:**

- "Auto" is available only when Image Processing mode has been set to "Line".  
 ↪ p.58

**Note:**

- Default Scanning Contrast can be set on the Admin. Screen.  
 ↪ p.167

**1 Touch [Contrast] on the Master Making Basic Screen.**

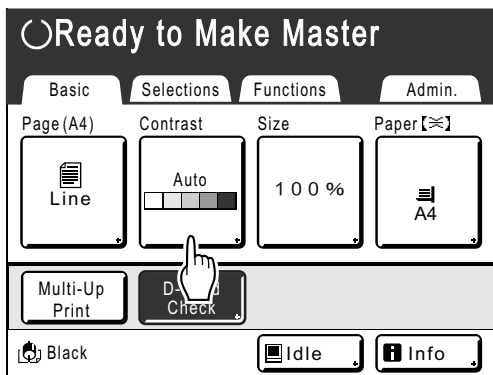

**2 Touch the desired contrast or [Auto].**

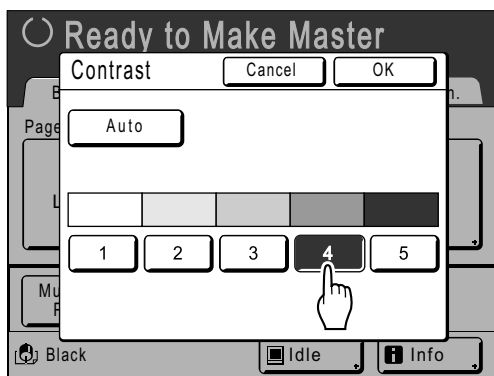

Levels of scanning contrast

- 1) : Very Light
- 2) : Light
- 3) : Standard
- 4) : Dark
- 5) : Very Dark

**3 Touch [OK].**

Returns to the Master Making Basic Screen. "Contrast" is updated.

# Enlarging/Reducing Originals

## [Standard Ratio] [Margin+] [Auto] [Free] [Zoom]

The document can be printed enlarged or reduced. The following methods can be used to enlarge/reduce the original:

### ◆ Standard Ratio

Enlarging or reducing a standard-sized original (A4, B5, Letter, Legal etc.) to print in another standard size.

### ◆ Margin+

Reducing the original slightly. This feature is useful when allowing binding margins, or when text or diagram extends beyond the printing area.

☞ p.19

Specify reduction rate of 90%-99% on the Admin. Screen.

☞ p.169

#### Note:

- “Margin+” and “Standard Ratio” can be selected at the same time.

### ◆ Auto

The original can be automatically enlarged or reduced to according to the paper size in the Paper Feed Tray.

### ◆ Free

The top/bottom and left/right of the original can be magnified or reduced and printed as desired.

Specify the zoom ratio between 50% and 200% in increments of 1%.

### ◆ Zoom

Allows you to specify numerical resize ratio.

Specify the zoom ratio between 50% and 200% in increments of 1%.

#### Note:

- To avoid paper jam, flipping or Ink smudges on the back side by design the machine does not print too close to the edge. The top edge in particular needs 5 mm ( $\frac{3}{16}$ " ) of margin space.

☞ p.19

5 mm ( $\frac{3}{16}$ " ) wide area on the top edge (marked ▲) of the Glass Platen (or the ADF unit) cannot be scanned, regardless of enlargement or reduction settings.

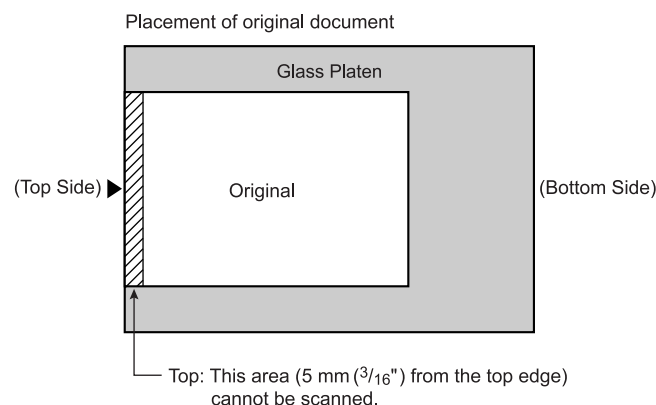

- Do not position the original within 5 mm ( $\frac{3}{16}$ " ) of the top edge, or the top edge of its printed image will be cut off. This 5 mm ( $\frac{3}{16}$ " ) margin will remain even in the “Max. Scan” setting.

☞ p.90

- If the original document has no margin on its top edge, the top 5 mm ( $\frac{3}{16}$ " ) of its print will be cut off even when “Margin+” is selected. Move the original about 5 mm ( $\frac{3}{16}$ " ) inwards from the top edge of the Glass Platen and reduce the size.

# Enlargement and Reduction by Standard Ratio

[Standard Ratio] [Margin+] [Auto]

## 1 Touch [Size] on the Master Making Basic Screen.

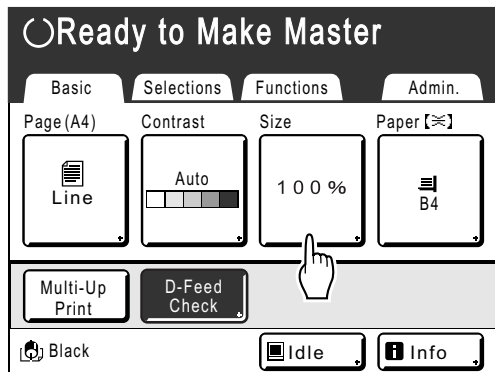

## 2 Touch the button corresponding to the desired size.

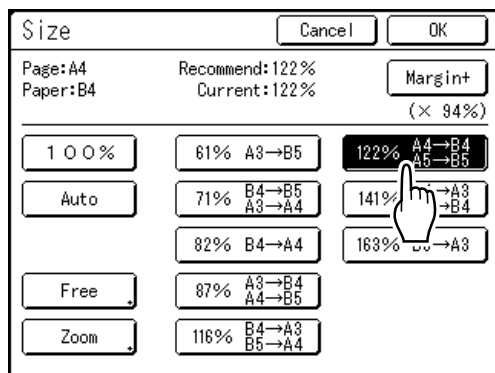

Touch **[100%]** to restore the original size.  
For original with no margins, touch **[Margin+]** before printing.

### Important!:

- The “Margin+” setting is not available when “Auto”, “Zoom” or “Free” is selected.

### Note:

- “Standard Ratio” and “Margin+” can be selected at the same time. The “Current” field will indicate the combined result of “Standard Ratio” × “Margin-Plus Rate” when both are selected.
- When the page size (original size) is not detected, “---” is displayed.

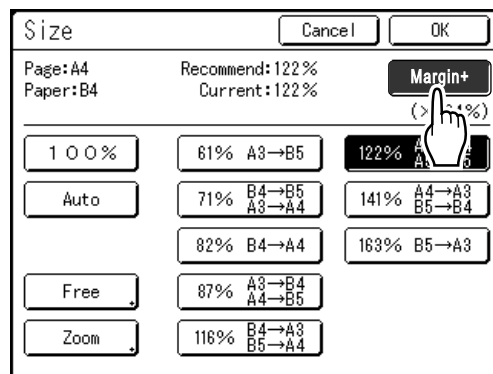

## 3 Touch [OK].

Returns to the Master Making Basic Screen.  
“Size” is updated.



# Enlargement/Reduction of a Changed Aspect Ration [Free]

## 1 Touch [Size] on the Master Making Basic Screen.

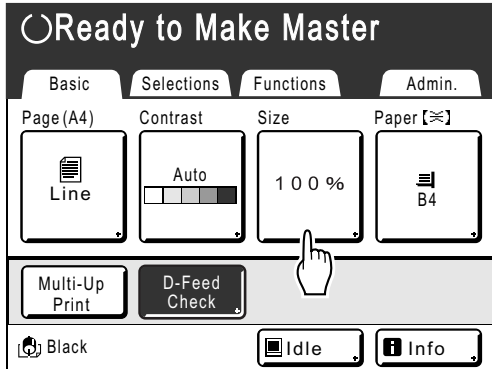

### Note:

- Print Quantity Keys can also be used to enter numbers.
- Press the **C** key to restore the original size (100%).

## 4 Touch [OK].

Returns to the Master Making Basic Screen. "Size" is updated.

## 2 Touch [Free].

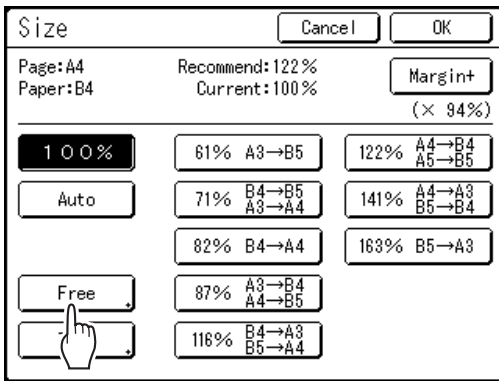

## 3 Touch or to adjust zoom ratio in horizontal or vertical directions.

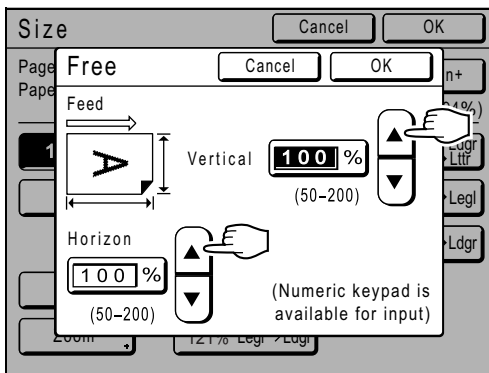

The reproduction size can be increased/decreased in increments of 1%.

## Enlarging and Reducing with the Zoom Function [Zoom]

### 1 Touch [Size] on the Master Making Basic Screen.

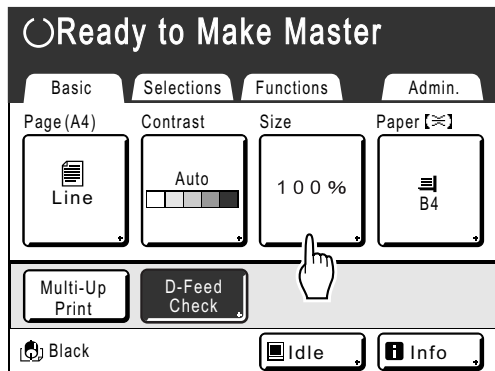

### 2 Touch [Zoom].

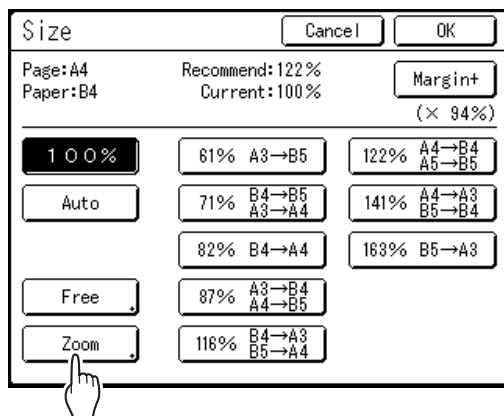

### 3 Touch ▲ or ▼ to change ratio.

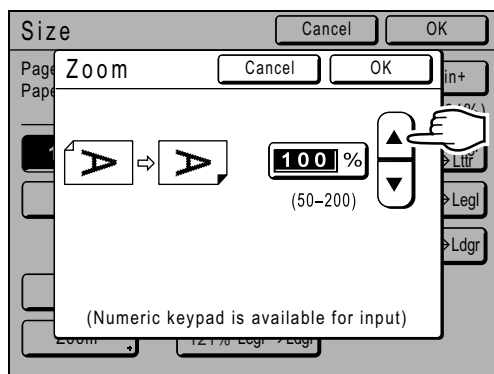

The reproduction size can be increased/ decreased in increments of 1%.

#### Note:

- Print Quantity Keys can also be used to enter numbers.
- Press the **C** key to restore the original size (100%).

### 4 Touch [OK].

Returns to the Master Making Basic Screen. "Size" is updated.

# Using Custom-Sized Paper [Paper]

The machine automatically detects standard-sized paper in the Paper Feed Tray to create master of correct size for printing. However, because non-standard paper sizes cannot be detected, they must be manually specified before a master is made.

## Important!:

- Custom paper size must be registered on the Admin. Screen. Failure to do so may make an incomplete master.  
☞ p.178

## 1 Touch [Paper] on the Master Making Basic Screen.

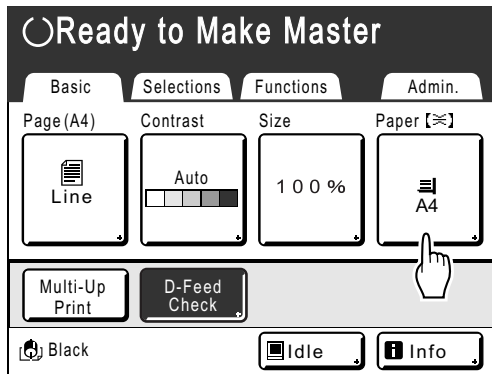

## 2 Touch the desired paper size.

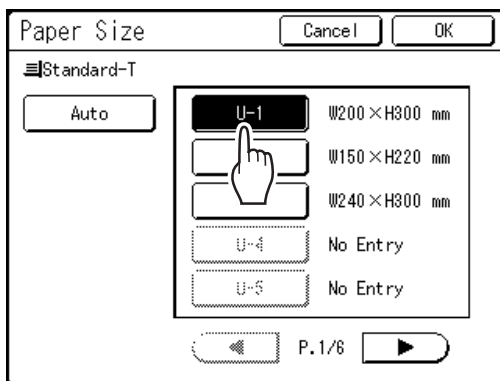

## Important!:

- Previously recorded custom paper sizes are displayed on this screen. Make sure to register any custom sizes not displayed here prior to use.  
☞ p.178

## Note:

- Touch [Auto] to use standard-size paper.

## 3 Touch [OK].

Returns to the Master Making Basic Screen. "Paper Size" is updated.

# Automatic Printing [Auto-Process]

Master-making and printing can be performed automatically in sequence.

When “Auto-Process” is selected, simply enter number of copies to print, then press the  key.

**Note:**

- When printing is completed, Print Quantity will restore the number originally entered.
- On the Admin. Screen, you can make such a setting that “Auto-Process” is always set to ON when you reset or start the machine.

 p.168

Press the  key.

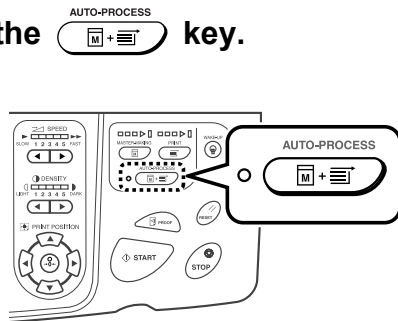

The Auto-Process indicator turns on.

**Note:**

- To cancel “Auto-Process”, press the  key again. The indicator turns off.
- With factory default settings, if multiple originals are placed in the optional ADF unit and “Auto-Process” is set to ON, all originals will be printed automatically.

# Processing Photos with Dot Screen

## [Dot Process]

“Dot Process” function processes photo originals with dot screening in order to print more clearly. Select from four types of dot patterns.

**Important!:**

- If an "Image" is set to "Line" or "Pencil", "Dot Process" cannot be used.

**1 Touch [Dot Process] on the Functions Screen.**

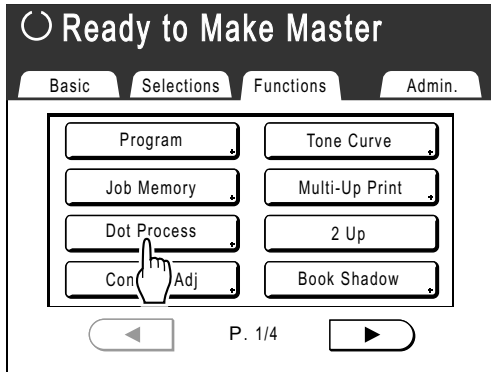



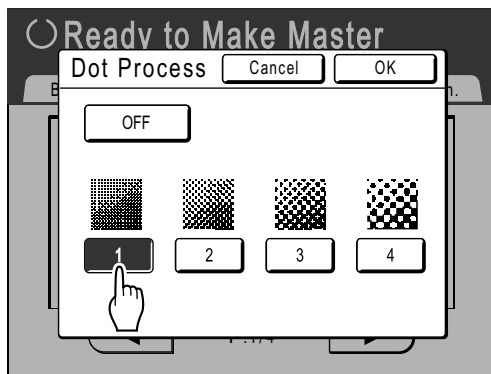

**3 Touch [OK].**

Returns to the Functions Screen. “Dot Process” setting is updated.

**2 Select a dot pattern.**



				
Number	1	2	3	4
Equivalent Lpi	212	106	71	53

**Note:**

- Touch **[OFF]** to cancel the “Dot Process”.

# Adjusting Photo Contrast [Contrast Adj]

For originals that have ill-defined photos, adjust the contrast to print more clearly. There are two ways to adjust the contrast.

**Important!:**

- If an “Image” is set to “Line”, “Duo”, or “Pencil”, “Contrast Adj” cannot be used.

**1 Touch [Contrast Adj] on the Functions Screen.**

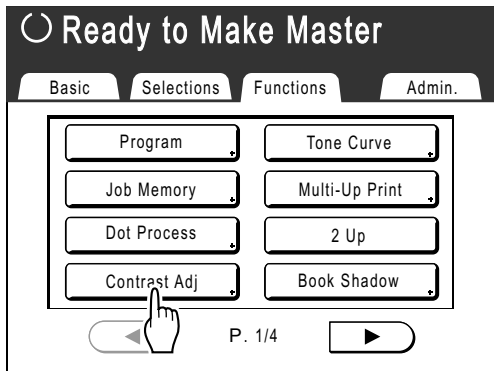

**2 Touch the button of the contrast to use.**

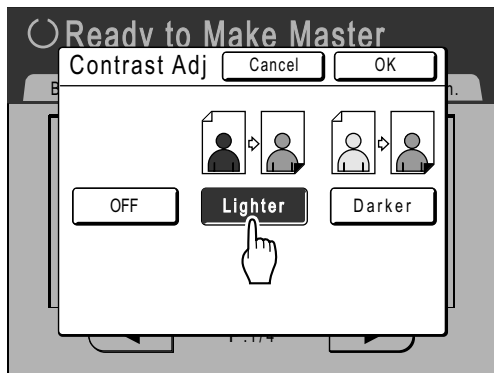

- **[Lighter]:** Lightens dark sections. Use this setting if the entire photo is underexposed and the target subject of the photo is ill-defined.
- **[Darker]:** Clarifies lighter portions. Use this setting if the entire photo is overexposed and the target subject of the photo is ill-defined.

**3 Touch [OK].**

Returns to the Functions Screen. “Contrast Adj” setting is updated.

# Adjusting Photo Gradation [Tone Curve]

You can adjust the light and shadow portions of a photo by 3 tones respectively.

## Important!:

- If an “Image” is set to “Line”, “Tone Curve” cannot be used.

## 1 Touch [Tone Curve] on the Functions Screen.

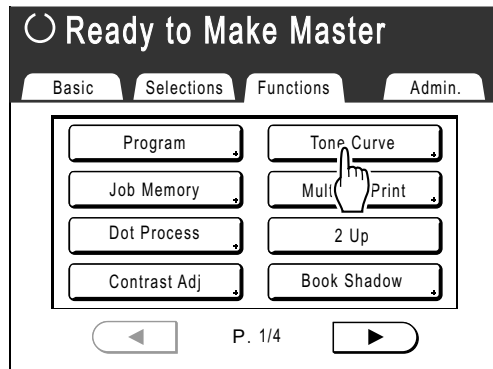

## 2 Touch the “Lights” and “Shadows” adjustment buttons.

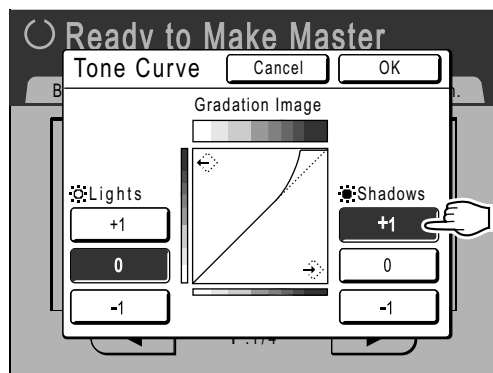

- **Lights:** Adjusts the portion of the picture most exposed to light.
- **Shadows:** Adjusts the portion of the picture least exposed to light.

Use [+1] or [-1] to strengthen or weaken each respectively.

## 3 Touch [OK].

Returns to the Functions Screen. “Tone Curve” setting is updated.

# Saving Ink [Ink Saving]

Selecting “Ink Saving” makes a master that requires less Ink when printing.

**Important!:**

- The Ink consumption saving process may result in lighter prints than usual.
- This function is not available at the time of printing. It must be selected before the master-making process is started.
- “Contrast” and “Print Density Adjustment” functions are not available when “Ink Saving” is selected.
  - ☞ p.60
  - ☞ p.99

## Touch [Ink Saving] on the Functions Screen.

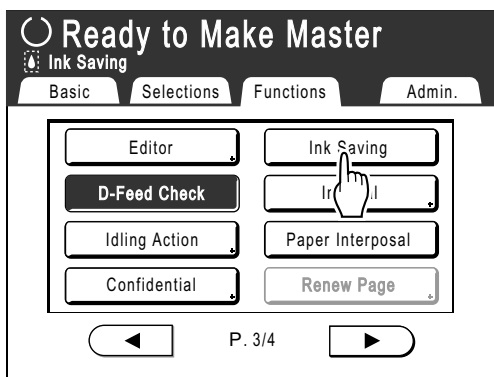

“Ink Saving” is set.

☞ Ink Saving” will appear in the message area.

**Note:**

- “Ink Saving” is a useful function for master-making. Even if this function is set or canceled during printing, it doesn't reflect on the master that is currently rolled around the Print Drum (Cylinder). The setting will be reflected on the next master.
- The ☞ icon is preferentially displayed in the message area even when [ECO mode] is set.



---

# Printing Multiple Originals on One Sheet

## [2 Up] [Multi-Up Print]

“Multi-Up” function prints multiple originals on one sheet.

### ◆ 2 Up

Prints two copies of the same original side-by-side on one sheet of paper.

### ◆ Multi-Up Print

One or multiple originals (up to 4) can be printed on a single sheet of paper.

“Multi-Up Print” has the following three types:

- Single-Original: A single original is printed multiple times.
- Multiple-Original: Multiple originals are printed multiple times.
- Multi-Up Tickets: You can print multiple long, thin custom originals such as tickets.

Single-Original and Multiple-Original can print in quantities of 2, 4, 8 and 16 respectively.

### Important!:

- Use standard-sized paper when using the “Multi-Up” function. With custom size paper placed, you cannot perform “Multi-Up” printing even when the size is stored on the Admin. Screen.

### Note:

- These functions cannot be used with the following functions:
  - Auto 90°Rotation
  - Top Margin
  - Book Shadow
  - Binding margin
  - Size (Auto)
  - Layout
  - Format (Auto) (in Scanning Mode)
  - Ink Saving (If you change the “Image” settings between originals in Multiple-Original)

## Original Orientation and Print Results

---

The orientation of the original differs depending upon the number of images. The orientation and print results for each possibility are shown below.

### 2 Up

Prints two copies of the same original side-by-side on one sheet of paper.

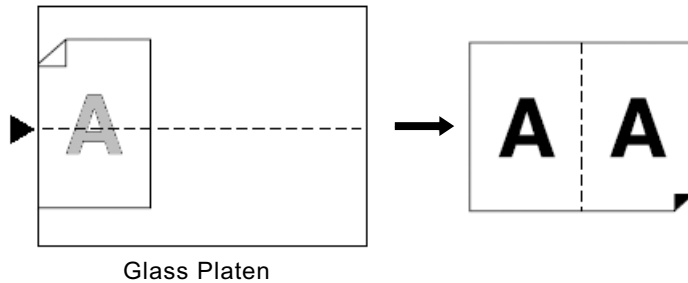

### Multi-Up Print

For Single-Original and Multiple-Original:

**Note:**

- When “Multiple-Original” is used in Multi-Up Print, the actual number of pages to be scanned is specified. In the case that the actual number of pages in the document is less than the number of pages specified in the mode settings, set equivalent number of blank pages in the machine to make up for the specified number. (For example, if you want to make eight pages and there are only three originals, add a blank page to the originals and set the four sheets for scanning.)

### ◆ 2 Up (2 on 1)

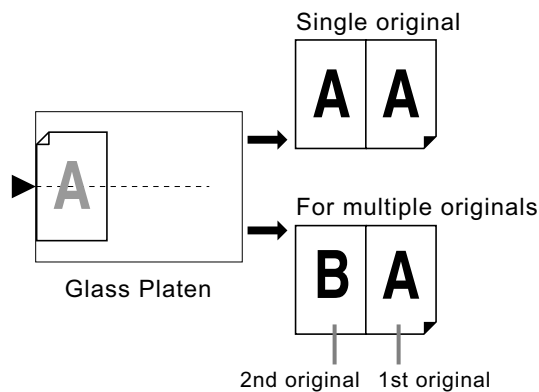

Up to 2 originals can be scanned.

◆ **4 Up (4 on 1)**

Prints four images of the original on one sheet of paper.

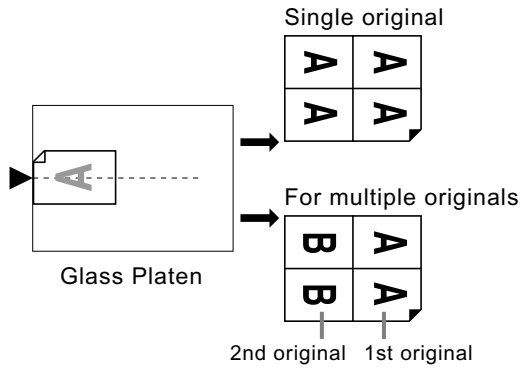

Up to 2 originals can be scanned.

◆ **8 Up (8 on 1)**

Prints eight images of the original on one sheet of paper.

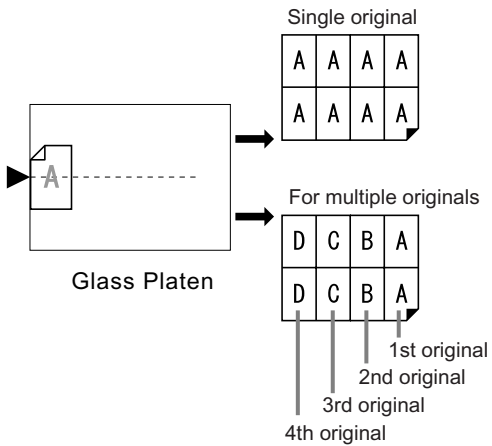

Up to 4 originals can be scanned.

◆ **16 Up (16 on 1)**

Prints 16 images of the original on one sheet of paper.

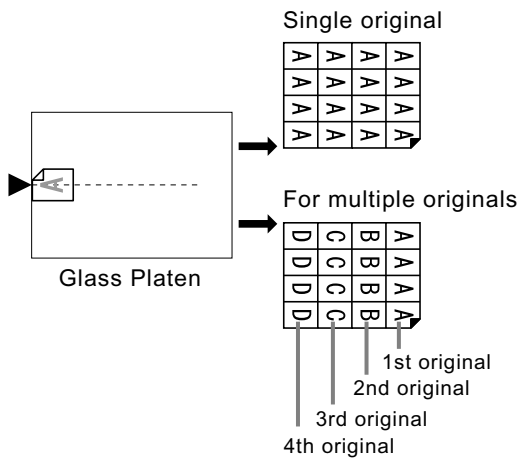

Up to 4 originals can be scanned.

◆ **For Multi-Up Tickets:**

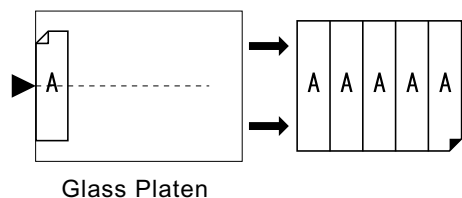

“Multi-Up Tickets” cannot be used with multiple originals.  
The number of images printed is determined by the width of the ticket.

## Margin

---

Leave a margin of at least 5 mm ( $3/16$ "") on the top edge of the Glass Platen. Allowing a proper margin is critical in well-balanced Multi-Up positioning.

☞ p.19

**Note:**

- A margin on the top edge will remain regardless of the enlargement or reduction settings.

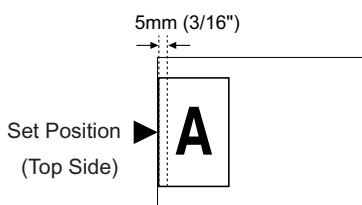

## Orientation of Print Paper

---

Always place paper in the Feed Tray as shown below.

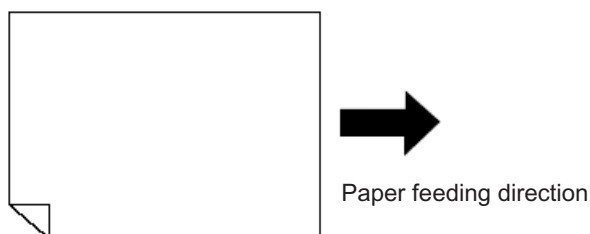

## Multi-Up Interval

---

"Multi-Up" scans a number of sheets of the original.

The interval between the first scan and the second scan is called "Multi-Up Interval".

Replace originals or change settings for the second scan during the "Multi-Up Interval".

**Note:**

- Default "Multi-Up Interval" can be set on the Admin. Screen. The factory default is 15 seconds. ☞ p.169

## 2 Up Operation

### 1 Set the original and print paper.

**Important!:**

- Pay attention to the orientation of the original. For “2 Up”, make sure to place the original as the diagram demonstrates. The same is true when using the ADF unit.

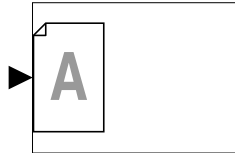

- Make sure to load paper as shown below (Portrait direction).

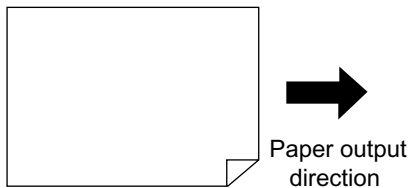

**Note:**

- With the optional ADF unit you can print two different originals side by side on a single sheet of paper (2 in 1 printing). Set the two originals one above the other.
- To print two copies of the same original side by side on a single sheet of paper (2 Up printing), set the original on the Glass Platen.

### 2 Touch [2 Up] on the Functions Screen.

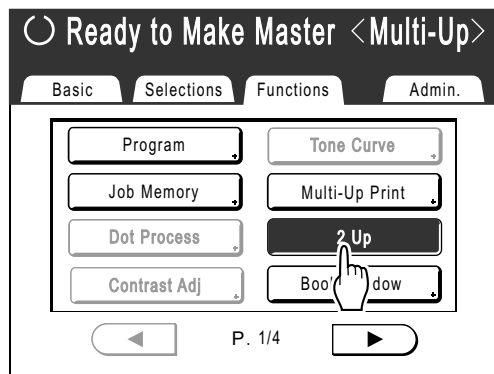

### 3 Make necessary settings.

Afterwards, perform the same operation as the normal master-making and printing process. The reproduction size needs to be set according to the combination of the original size and printing paper size. Set the reproduction size by referring to the following tables:

		Original			
		A4	B5	A5	B6
Printing Paper	A3	100%	116%	141%	163%
	B4	87%	100%	123%	142%
	A4	71%	82%	100%	116%
	B5	61%	71%	87%	100%

		Original			
		A6	B7	A7	B8
Printing Paper	A3	200%	---	---	---
	B4	173%	200%	---	---
	A4	138%	163%	200%	---
	B5	122%	141%	173%	200%

		Original	
		Letter	Statement
Printing Paper	Ledger	100%	127%
	Legal	77%	100%
	Letter	66%	100%
	Statement	50%	66%

### 4 Press the key.

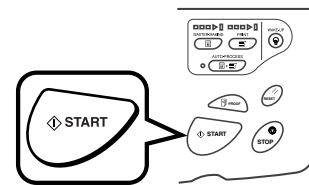

Starts scanning the original.

# Operation for Multi-Up Printing

## 1 Set the original and print paper.

**Important!:**

- Pay attention to the orientation of the original. [p.72](#)
- Make sure to load paper as shown below (Portrait direction).

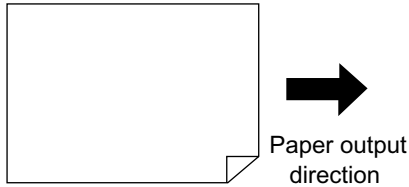

**Note:**

- It is convenient to place all originals in the optional ADF unit when using the “Multiple-Original” mode. [p.41](#)

## 2 Touch [Multi-Up Print] on the Functions Screen.

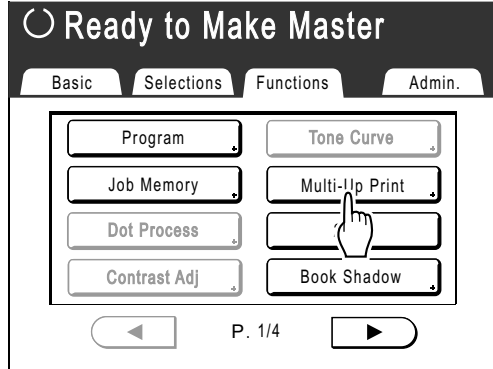

## 3 Select the Page Size to use.

Touch the Page Size same as the original and touch **[Next]**.

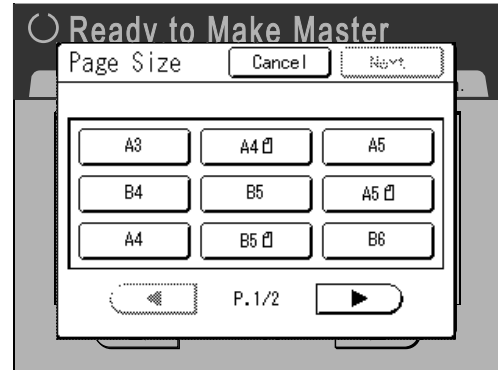

Reproduction Size is set automatically and Multi-Up Print screen is displayed.

## 4 Touch [Single] for Single-Original, touch [Multiple] for Multiple-Original.

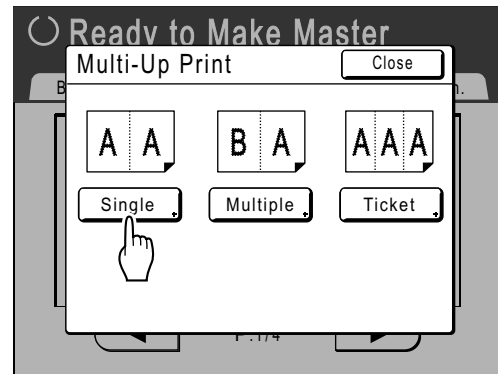

## 5 Touch the button of the number of images to use.

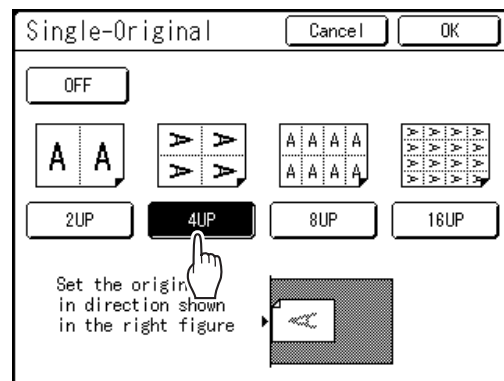

To cancel the “Multi-Up Print” settings or return to the previous screen, touch **[Cancel]**.

## 6 Touch [OK].

Returns to the Functions Screen. “Multi-Up Print” setting is updated.

The reproduction size is automatically set according to the selected number of images based on the paper size and original size to use.

## 7 Make necessary settings.

Make various settings as needed.

- When the reproduction size is set before setting Multi-Up Print, the reproduction size is invalidated and changes to the size setting suitable for the selected number of images.
- The image of the 2nd original and subsequent originals can be changed to something different from the image of the 1st original.

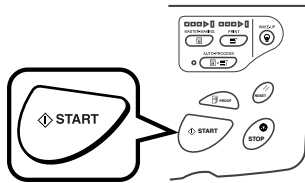

## 8 Press the key.



Scanning the original starts.

After scanning has finished, follow the usual steps to print.

### Important!:

- After displaying the message, “Place Another Original and Press Start Key. To Cancel, Press Stop Key” the machine waits for the next original to be loaded. Set the next original and press . Press  to cancel the “Multi-Up Print” mode.
- The Glass Platen and the optional ADF unit cannot be used at the same time. If using the Glass Platen to scan the first sheet of the original, you must continue to use the Glass Platen to scan the rest of the document.
- To scan the original with the optional ADF unit and use the “Single-Original”, you need to set the original twice.

### Note:

- When “Multiple-Original” is used in Multi-Up Print, the actual number of pages to be scanned is specified. In the case that the actual number of pages in the document is less than the number of pages specified in the mode settings, set an equivalent number of blank pages in the machine to make up for the specified number or press the  key in the status of waiting for the next original. Master-making starts.   
→ p.72 “Original Orientation and Print Results”
- When using the “Auto Process” setting, printing will continue automatically when an original is set on the ADF unit.
- To cancel a “Multi-Up Print” setting once it has been confirmed, follow step 2, touch [OFF] and then [ON] on the screen.

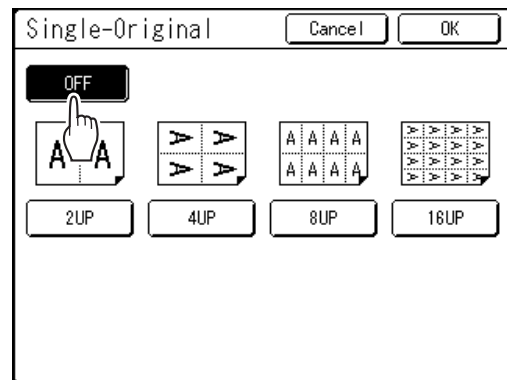

# Operation for Multi-Up Tickets

For "Multi-Up Tickets", the specification of the short edge size of the original (the width) is used to calculate the number of images that can be printed on one sheet of paper (print paper size divided by short edge size of the original). A ticket width of between 50 mm (2") and 210 mm (8<sup>1</sup>/<sub>16</sub>" ) can be specified.

Ex.)

Short edge of the original 50 mm (2")

Long edge of the print paper 297 mm (11<sup>11</sup>/<sub>16</sub>" ) (A4 size)

$297 \div 50 = 5$  (  $11^{11}/_{16} \div 2 = 5$  ) with a remainder of 47 mm (1<sup>11</sup>/<sub>16</sub>" )

In this example, 5 images print on one sheet of paper.

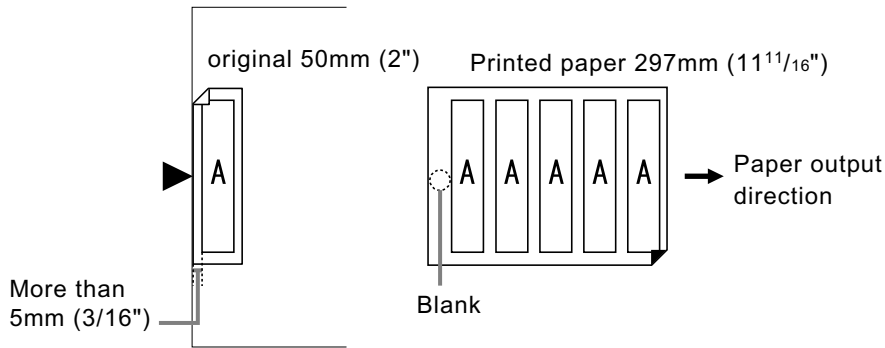

## 1 Set the original and print paper.

Place the original on the Glass Platen.

### Important!:

- Pay attention to the orientation of the original.
- Make sure to load paper as shown below.

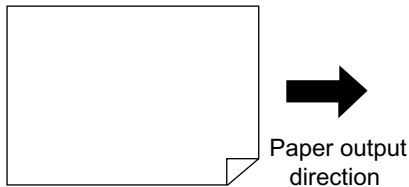

## 2 Touch [Multi-Up Print] on the Functions Screen.

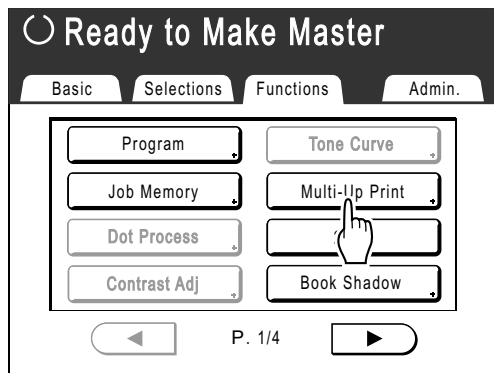

## 3 Select the Page Size.

Touch the Page Size same as the original and touch **[Next]**.

(In "Multi-Up Tickets", the Page Size selection will not affect the rest of the procedures.)

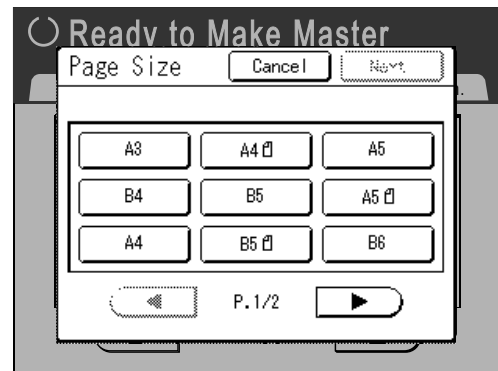

Reproduction Size is set automatically and Multi-Up Print screen is displayed.



#### 4 Touch [Ticket].

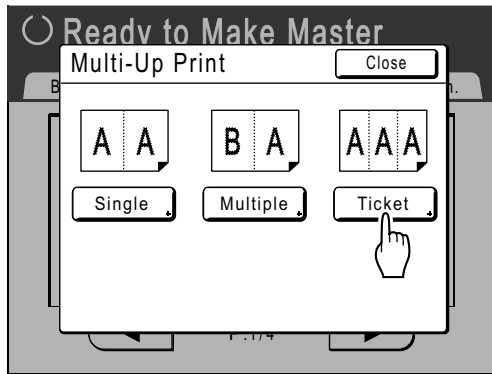

#### 5 Touch [ON].

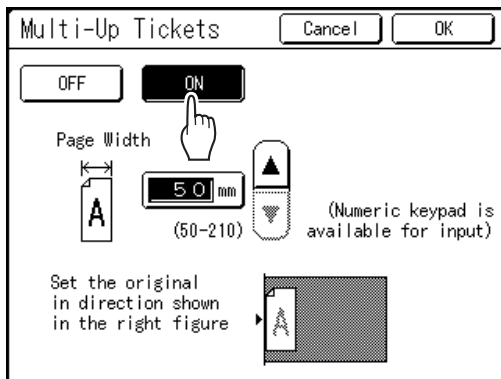

You can specify the "Page Width".

#### 6 Touch ▲ or ▼ to specify the short edge size of the original (the width).

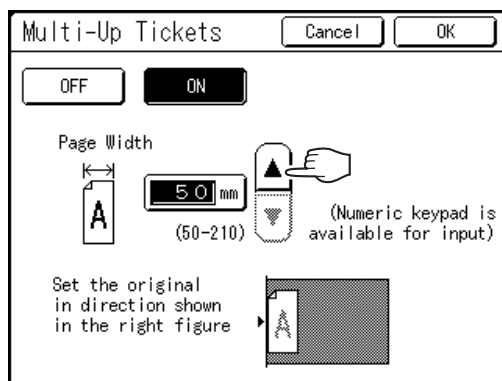

#### Important!:

- If you have enlarged/reduced size in step 8 (setting print functions), be careful about the following points:
  - Specify the ticket width after enlarging/reducing.
  - If you magnified the size, make sure that the bigger size does not exceed the specified "Page Width" or the short edges of the print paper.
  - When magnifying, make sure to prepare paper that fits the enlarged size.

#### 7 Touch [OK].

Returns to the Functions Screen. "Multi-Up Tickets" setting is updated.

#### 8 Make necessary settings.

Make various settings as needed.

#### 9 Press the key.

Starts scanning the original. After this, please follow the same operations for normally printing.

#### Note:

- To cancel a "Multi-Up Print" setting once it has been confirmed, follow step 2, touch [OFF] and then [OK] on the screen.

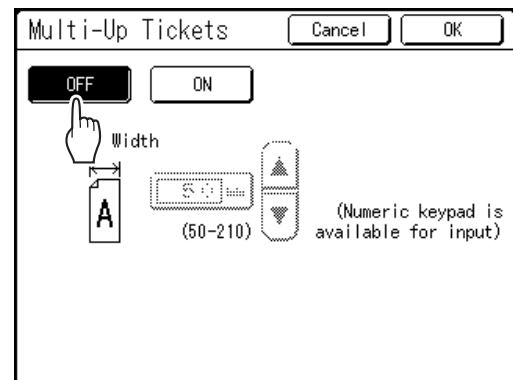

# Laying out continuous originals on one sheet of paper [Layout]

Continuously arranging several originals on one sheet of paper is called “Layout”. This function is convenient when you want to save paper and make stapled documents.

## Important!:

- “Layout” function cannot be used with “Auto 90°Rotation”.

## Setting items

### ◆ Page Size setting

Set the size of original to use.

#### Important!:

- The reproduction size is determined from the page size and printing paper size. When the reproduction size is not appropriate, an error message is displayed. In such case, use a printing paper of different size or change the size of the original.

### ◆ Number of images

Set the quantity of originals to be laid out on one sheet of paper.

- 2UP
- 4UP
- 8UP
- 16UP

### ◆ Original orientation (direction of text on the original)

The original orientation is determined by the set number of images. Set the original according to the orientation of characters on the original seen from the front side.

#### Align Top

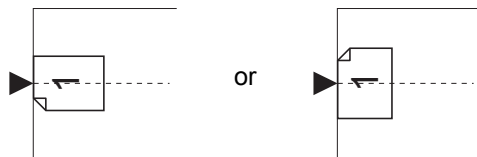

#### Align Side

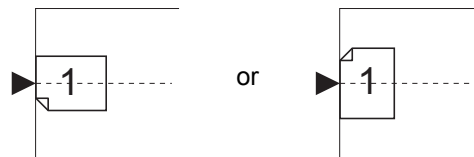

◆ **Layout order**

Set the order of the images when the printed paper is placed in the orientation that allows the characters on the original to be read.

Ex.) Number of images: 8UP, Original orientation (orientation of characters on the original): Align Side

**L-top to R**

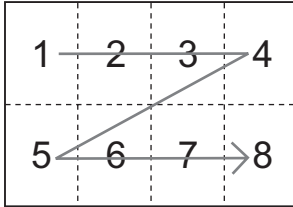

**R-top to L**

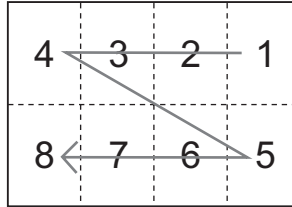

**L-top to B**

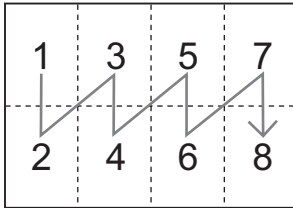

**R-top to B**

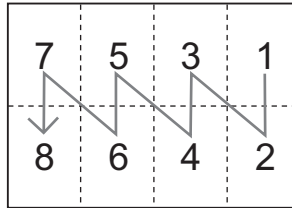

**Note:**

- Depending on the “Number of images” and “Original orientation” settings, the possible settings for “Layout order” differ.

### 1 Set the original and print paper.

Place the original on the Glass Platen or in the optional ADF unit.  
To place the original, see p.41.

**Important!:**

- Be careful with the orientation of the original.
- Make sure to set the printing paper in the orientation shown in the figure below (the long side points in the direction of transfer).

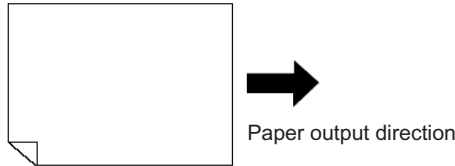

### 2 Touch [Layout] on the Functions Screen.

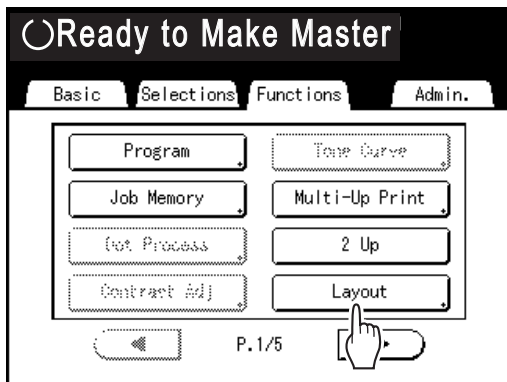

### 3 Select the page size to use.

Touch the button corresponding to the size of the original and touch [Next>].



The reproduction size is automatically set and the Layout Screen is displayed.

### 4 Touch the button for the number of images to set.

Touch the button for the number of images to be laid out and touch [Next>].

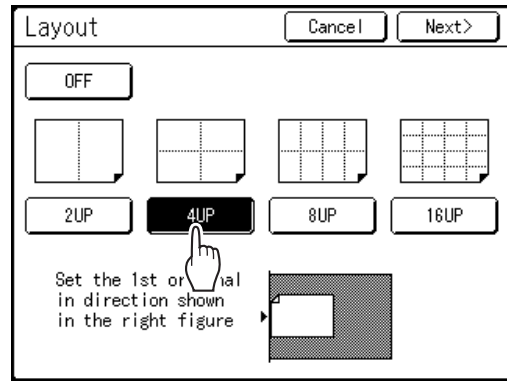

**Important!:**

- Check if the orientation of the originals has been set in the direction determined for the set number of images.

**Note:**

- To cancel the Layout setting, touch [Cancel].

### 5 Set the orientation of characters of the original.

Select [Align Top] or [Align Side] for the orientation of characters on the original seen from the touch panel side.

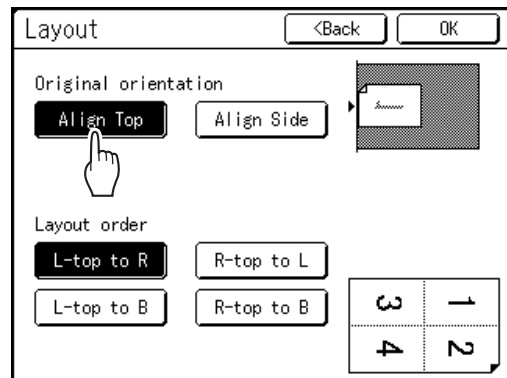

### 6 Touch the layout order button to set.

### 7 Touch [OK].

“Layout” is set and the Functions Screen appears.

## 8 Configure print functions.

Set various functions as needed.

## 9 Press the key.

Scanning of 1st page of the original starts.

## 10 Scan all originals and make a master.

When you set the original on the Glass Platen, replace the original and repeat steps 8 and 9. Repeat scanning until the set number of images have been scanned.

If the original has less pages than the set number of pages, touch  → **[Yes]** after all of the original has been scanned. The unscanned part becomes blank.

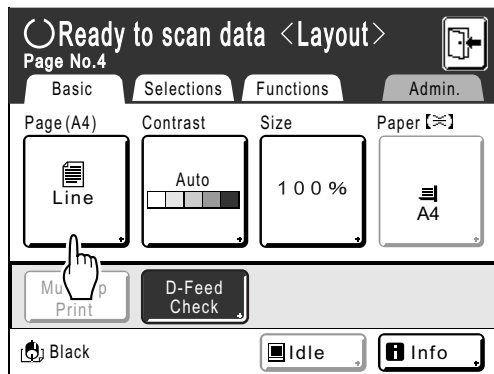

When original scanning is complete, a master is made and the Printing Basic Screen is displayed.

### Note:

- The original is laid out in the scanned order.
- If you want to cancel the layout setting after setting the number of images, perform step 2 to display the Layout Screen. Touch **[OFF]** and then **[OK]**.

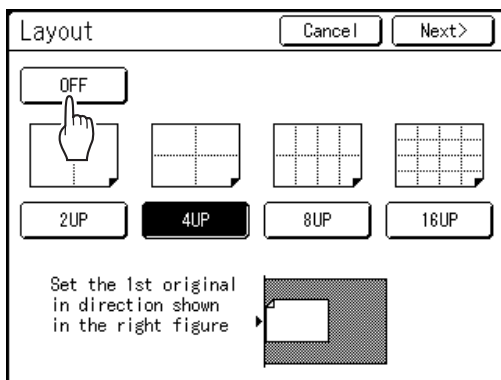

# Printing from Bound Documents

## [Book Shadow]

You can erase the binding “spine” shadow in the center when printing from such bound originals with facing as magazines and books.

You can select the area to be erased (erasure width).

Moreover, magazines or books can be spread open on the Glass Platen and their pages printed onto separate sheets.

### Important!:

- The original must be placed aligning center on the Glass Platen as shown below.

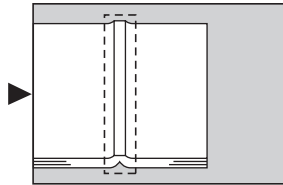

- If the erasure width is set to “Auto”, the following image areas are also erased (or half-toned).
  - A continuous black image area (non-white) from the edge of the original

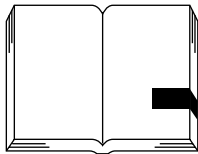

- A continuous black image area from the center of the original

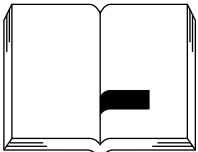

### Note:

- Book Shadow function cannot be used with the following functions:
  - Top Margin (when **[Page split]** is selected)
  - Binding margin
  - Ink Saving
  - Scanning Contrast (**[Auto]**)
  - Multi-Up Print
  - Scanning Side -ADF
  - Layout
- If you use the “Book Shadow” with the Gauge Cover installed, the surrounding image gets black on the master. If a Gauge Cover is installed, remove the Gauge Cover and then use the “Book Shadow”.
- If you are scanning a thick book such as an encyclopedia, raise the hinge of the glass platen cover and press down for best results.



# Erasing Shadows when Printing

## 1 Touch [Book Shadow] on the Functions Screen.

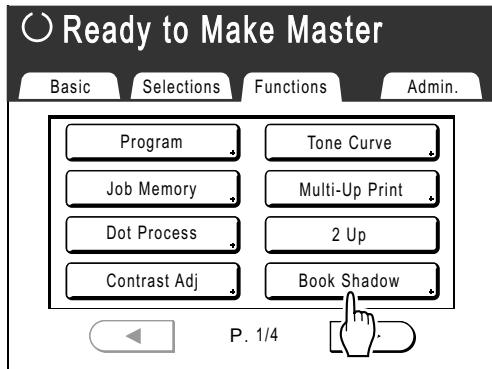

## 2 Touch [Erase] or [Halftone] for "Process".

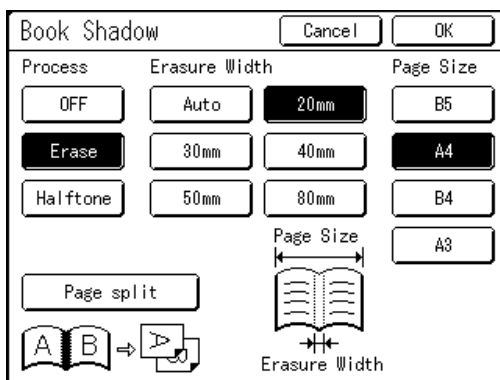

- **[OFF]**: Book Shadow is not performed.
- **[Erase]**: Erases shadows near the center and around the original.  
Select the size of spread original from "Page Size".
- **[Halftone]**: Photo processes the center shadow for a natural feel and deletes shadows that it can around the original.

## 3 Touch [Erasure Width] and [Page Size].

- If you set "Process" to "Halftone", you can only select "Auto".
- If you set "Erasure Width" to "Auto", original detection is performed automatically, and the erasure width is calculated from the detected size.

- If you specify the erasure width, original detection is not performed automatically. Touch [Erasure Width], and then touch the [Page Size] for the magazine or book you have placed.

### Note:

- If you also select "Page split", you can print the left and right pages of a bound original separately. See "Splitting Facing Pages of a Bound Original when Printing" (p.86).

## 4 Touch [OK].

Returns to the Functions Screen. "Book Shadow" setting is updated.

# Splitting Facing Pages of a Bound Original when Printing [Page split]

**1 Touch [Book Shadow] on the Functions Screen.**



**2 Touch [Erase] or [Halftone] for "Process".**

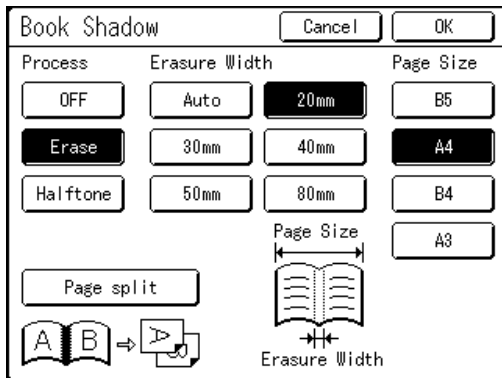

**3 Touch [Page split].**

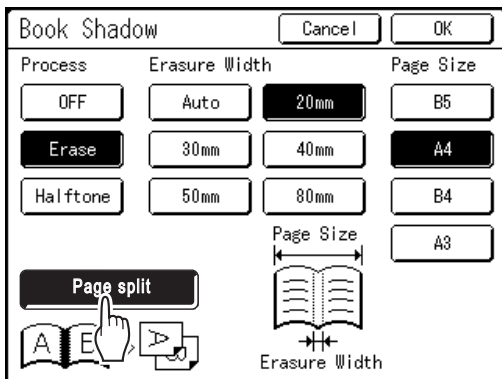

If you set "Process" to "OFF", you cannot select "Page split".

**4 Touch [B5], [A4], [B4] or [A3] for the magazine or book you have placed.**

**Note:**

- Select the size of the bound original.

**5 Touch [OK].**

Returns to the Functions Screen. "Book Shadow" setting is updated.

**Note:**

- When "Page split" is set, the original is scanned twice.

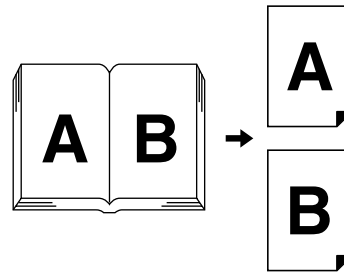

- In this case, "B" is printed first.

**Important!:**

- When "Page split" is set, use A4 or B5 as printing paper.
- To set the reproduction size, it is recommended to use [Auto].
- Make sure to set the printing paper in the orientation shown in the figure below (the long side points in the direction of transfer).

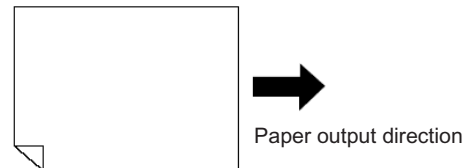



# Cutting the Top Margin of the Original and Printing [Top Margin]

You can cut the top portion of the margin to between 0 to 99 mm (0.0" to 3.9") and make a master.

This feature enables you to skip the Registration marks\* on the original and print on the finish-sized paper without any of these marks.

\* About the Registration Mark

In the field of commercial printing, it is normal to print on paper that is larger than the finished size and then cut down to the finished size afterwards. The symbol that indicates the position to cut in this event is known as the registration mark.

## Important!:

- When you are setting the "Size", magnify/reduce using the area that skips the set value.
- Do not use "Auto Reproduction Size".
- This function cannot be used with "Multi-Up Print" or "2 Up".

## 1 Place an original.

Place the original face down on the Glass Platen. Align center on the top edge, and close Platen Cover. [p.41](#)

## 2 Touch [Top Margin] on the Functions Screen.

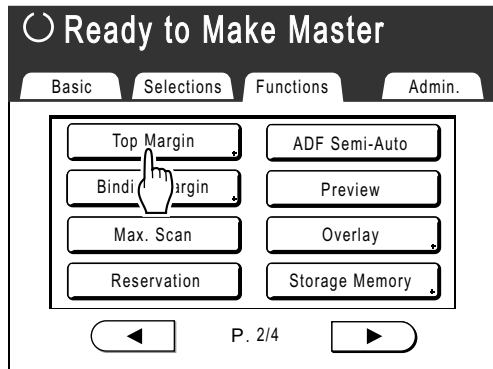

## 3 Touch [ON].

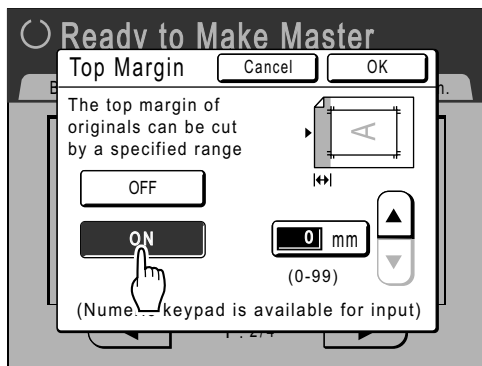

## 4 Touch or to specify the cut width.

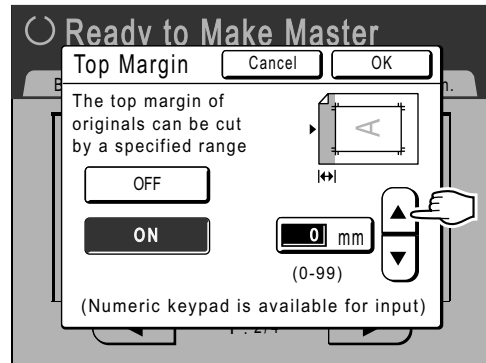

You can set from 0 to 99 mm (0.0" to 3.9").

### Note:

- Print Quantity Keys can also be used to enter a value.

## 5 Touch [OK].

Returns to the Functions Screen. "Top Margin" setting is updated.

# Adjusting the Master-Making position

## [Binding Margin]

You can make a master by putting the binding margin on either the top, bottom, left and right of the original. The adjustable range is from 0 to 50 mm (0.0" to 1<sup>31</sup>/<sub>32</sub>" ) on the top, bottom, left and right.

### Important!:

- “Binding margin” is a function for adjusting the master-making position and not a function for adding a binding margin.
- When the original has no margin, the image may extend out of the area for master-making. The part that is outside the master-making area is not used for master-making.
- The position of the binding margin is the side that appears first when printed copies are discharged to the Paper Receiving Tray.
- The binding margin can be set to either the Top, Bottom, Right, and Left of printed copies.
- When auto reproduction is set, move the image to where it should appear after the magnification has been adjusted.
- This function is available with “Auto 90°Rotation” and Rotate”.

### Note:

- When the Print Position Adjustment on the control panel is used in combination with the binding margin, the Output Print Position can be moved up to approx. 65 mm (2<sup>9</sup>/<sub>16</sub>" ) vertically and 60 mm (2<sup>23</sup>/<sub>64</sub>" ) horizontally with respect to the position of the original image.
- This function cannot be used with the following functions.
  - Multi-Up Print
  - 2 Up
  - Overlay
  - Scanning Side -ADF
  - Layout

**1 Touch [Binding Margin] on the Functions Screen.**

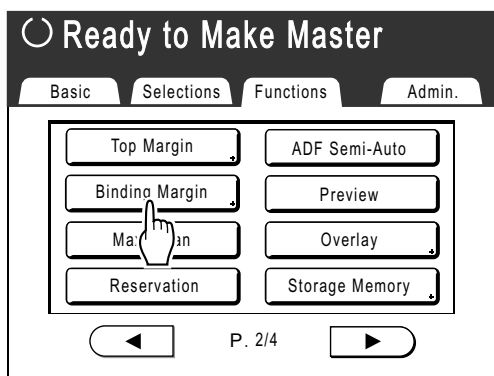

**2 Touch [Top], [Bottom], [Left], [Right] for the desired adjustment.**

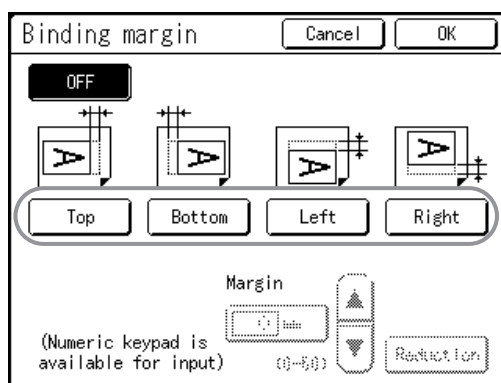

### 3 Touch ▲ or ▼ to specify the shift distance.

**Note:**

- Print Quantity Keys can also be used to enter a value.
- When you touch **[Reduction]**, the image without a Shift designated for the Margin mode becomes the print image and the size is reduced around the center of the print image so that the original is completely printed within the paper.

### 4 Touch [OK].

The binding margin shift is set and the Functions Screen appears.

**Note:**

- When you want to cancel the once fixed binding margin, either press the  key or touch **[OFF]** in step 2, and then touch **[OK]**.

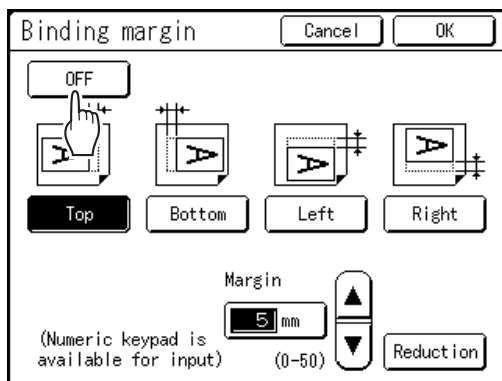

# Making a Master that Utilizes the Maximum Printing Area [Max. Scan]

When a master is made, automatic paper size detection and image size adjustment applies to allow appropriate print margins. This is to prevent paper jams, and keep the internal roller free of Ink stains.

By selecting "Max. Scan", maximum printing area will apply to the scanned image, regardless of the print paper size or original document size.

Be sure to check the sizes of the original document and the printing paper first.

☞ p.16

## ◆ Maximum printing area

SE9480: 291 mm × 425 mm (11<sup>15</sup>/<sub>32</sub>" × 16<sup>23</sup>/<sub>32</sub>" )

SE9380: 291 mm × 413 mm (11<sup>15</sup>/<sub>32</sub>" × 16<sup>1</sup>/<sub>4</sub>" )

### Important!:

- The 5 mm (<sup>3</sup>/<sub>16</sub>" ) margin on the top cannot be scanned even in the "Max. Scan" setting.
- Do not use print paper smaller than the area of the image made on the master.
- The entire surface of the Glass Platen must be clean. This may cause Ink stains.  
By scanning the maximum size, dirt found outside the original document area will also be included in the master.  
This may cause the internal roller to be stained with Ink.

### Touch [Max. Scan] on the Functions Screen.

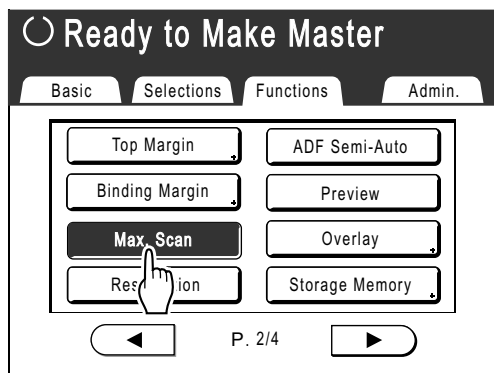

"Max. Scan" is selected.

# Rotating the Original 180 Degrees to Make a Master [Rotate]

When you are direct printing, you can rotate the original data received from a computer 180 degrees to make a master. When this function is used for the original data of a wide range of solid colors on the top side, you can prevent paper jams.

**After the machine receives the original data, touch [Rotate] on the Functions Screen.**

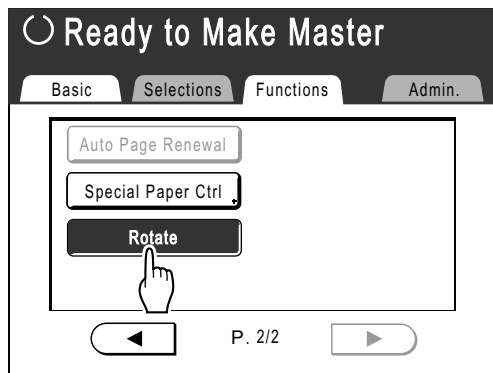

"Rotate" setting is updated.

**Note:**

- When you send the original data from a computer, set "Auto Process" to **[OFF]** or **[Pause before "Master"]**.

# Checking the Print Image Prior to Making Master [Preview]

You can check what the actual master will look like by previewing an image of the scanned original or an image of the data sent from a computer. This function is handy for checking the layout or final image of a Multi-Up job. The operation and display timing differ depending upon the mode.

Mode name (original type)	When set	When to display	If "Auto Processing" is ON
Printing from the Original Document	When setting functions related to Master Making (settings from Functions)	After Scanning the Original	Scans the original, then temporarily stops to display the preview.
Scan Mode	When setting functions (master making functions) related to Scanning (setting from Functions)	After Scanning the Original	There is no "Auto Process" in scan mode, but if multiple originals are placed in an ADF unit, you can touch <b>[Close]</b> after viewing the preview to start scanning the next original.
Printing Original Data from a Computer	Stopping the print job prior to making a master (Pause before "Master"/Auto-process "OFF"), after the machine has received the original data	After <b>[Preview]</b> is touched	A preview is not shown if data is sent from the printer driver with "Auto Print" "ON".
Retrieving Stored Data/ USB Flash Drive data and printing	When selecting data to be printed on the <b>[Storage Selection]</b> Screen (set on the <b>[Storage Retrieve]</b> Screen)	Immediately after touching <b>[Preview]</b>	When you touch <b>[Retrieve]</b> , the data is retrieved and the Master Making Basic Screen for saved data is displayed.
	When touching <b>[Retrieve]</b> on the <b>[Storage Retrieve]</b> Screen/ <b>[USB Job List]</b> Screen and retrieving saved data (set on the Master Making Basic Screen for saved data)	Immediately after touching <b>[Preview]</b>	Displays immediately when you touch <b>[Preview]</b> on the retrieved screen. When you touch <b>[Close]</b> , you will return to the Master Making Basic Screen for saved data.

**Note:**

- It shows the scanned original as-is. A margin is required when actually printing. Check to make sure that the margins are sufficient. Also, the actual print is confined to the maximum printing range of the Print Drum (Cylinder), so the image may be cut off. [p.19](#)
- In "Direct Print" operation, **[Preview]** will be displayed on the Master Making Basic Screen when data is received from the computer. [p.55](#)

## Actions Available on the Preview Screen

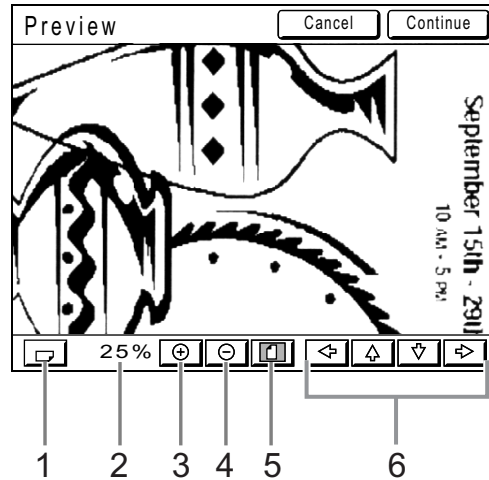

- |   |  |
|---|--|
| <p><b>1) Rotate Image Button</b><br/>Allows you to rotate the displayed image 90 degrees.</p> <p><b>2) Displays the size of the current display.</b></p> <p><b>3) Enlarge Button</b><br/>Magnifies the preview display each time it is touched.</p> | <p><b>4) Reduce Button</b><br/>Shrinks the preview display each time it is touched.</p> <p><b>5) Show All Button</b><br/>Shows the entire image.</p> <p><b>6) Scroll Button</b><br/>The image moves in the direction of the displayed arrow.</p> |
|---|--|

## Checking and Printing the Preview Display

The operational procedures for “Printing from the Original Document” are explained below.

- 1 Place an original.**
- 2 Touch [Preview] on the Functions Screen.**

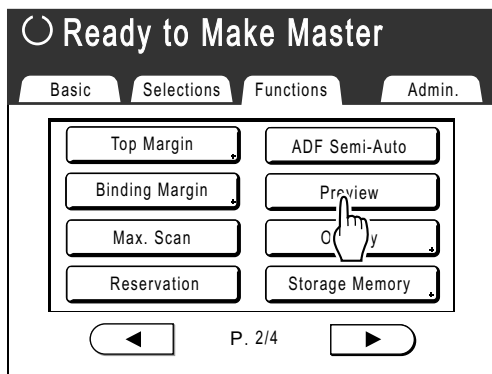

“Preview” setting is updated.

- 3 Make necessary settings.**  
Make various settings as needed.

- 4 Press the  key.**

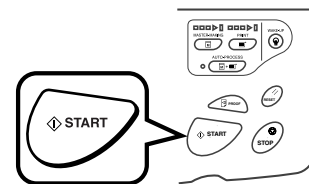

A scan of the original begins, and can be previewed on the Preview Screen.

## 5 Check the preview image.

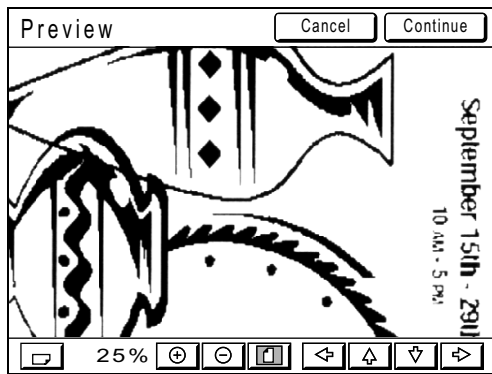

## 6 Touch [Continue].

A master is created.

After this, please follow the same operations for normally making a master.

### Note:

- Touching **[Cancel]** will cancel the image, returning to the Master Making Basic Screen. To resume preview operation, repeat from step 3.





# Functions for Printing

## Changing the Print Speed

### [Print Speed Adjustment]

You can select the print speed from five levels; from 60 to 130 sheets/minute.  
You can adjust the print speed while printing is in progress.

#### Note:

- In cases where printing noise is excessive, decrease the print speed or use “Silent” mode.  
☞ p.98
- Set the default print speed on the Admin. Screen.  
The factory default is level 3 (approximately 100 sheets/minute).  
☞ p.167
- When [ECO mode] is set, the default print speed is “3”. You can adjust the print speed when the ECO mode is set.  
☞ p.167 [Print Speed]  
☞ p.167 [Print Density]

Press the ◀ or ▶ key to adjust the print speed.

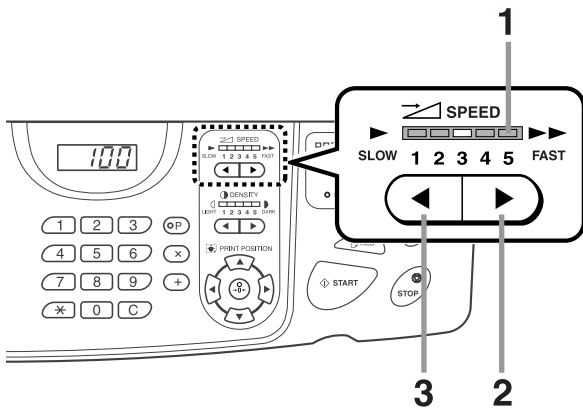

- 1) **Print Speed Indicator**  
Shows the current print speed.
- 2) **▶ Key**  
Increases the print speed incrementally.
- 3) **◀ Key**  
Decreases the print speed incrementally.

#### Indicator level and print speed

Indicator Level	1	2	3	4	5
Print Speed (sheets/minute)	Approx. 60	Approx. 80	Approx. 100	Approx. 120	Approx. 130

#### Note:

- The Functions Screen has a “High Speed” function for faster printing.  
☞ p.97

# Printing at High Speed [High Speed]

By using “High Speed”, you can print faster than you can by simply adjusting the “Print Speed”.

If the following conditions are satisfied, the machine prints at a speed of about 185 sheets/minute. If the conditions are not met, the machine prints at a speed of about 180 sheets/minute.

- Internal temperature of the Print Drum (Cylinder) when printing starts is 20°C (68°F) or higher
- Print paper size is a standard size of A4/Letter or smaller
- Vertical shift of the print position is within ±10 mm ( $25/64$ " )
- “Interval Printing” is not set

### Important!:

- When the internal temperature of the Print Drum (Cylinder) is below 15°C (59°F), **[High Speed]** is grayed out and cannot be used. Use the normal print speed adjustment (1 to 5) until the internal temperature of the machine is higher than 15°C (59°F). The time it takes for the internal temperature to rise depends upon the machine environment.

### Touch [High Speed] on the Print Basic Screen.

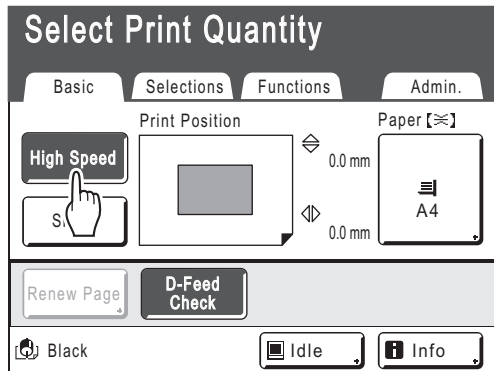

Print speed is set at “High Speed” and the Print Speed indicator on the Control Panel is off.

### Note:

- To slow down printing speed from "High Speed", touch [High Speed] again or set the speed with the  key on the Control Panel.
- By registering to the DirectAccess area, you can set “High Speed” by a single touch during the printing process.  
p.164
- Paper jams may occur more often, depending on the type of paper you use. In this case, print at the normal speed.
- If the conditions to print at a speed of 185 sheets/minute are met, the following icon is displayed during “High Speed” printing.

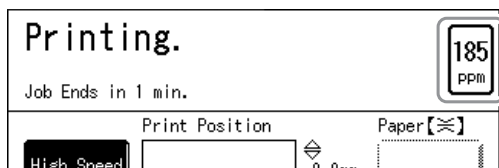

# Printing More Quietly [Silent]

In “Silent” mode, print speed is automatically adjusted to reduce noise levels.

**Touch [Silent] on the Print Basic Screen.**

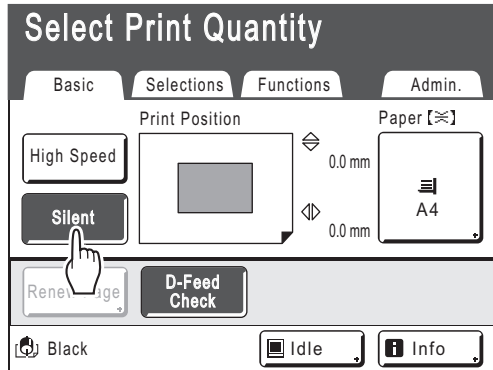

“Silent” mode is set.

Selecting “Silent” mode reduces the print speed. (Print Speed 1).

**Note:**

- To cancel “Silent” mode during printing, touch **[Silent]** to return to the previous speed.
- The Print Speed Adjustment Keys on the Control Panel can also be used to change print speed.

# Adjusting the Print Density

## [Print Density Adjustment]

You can select the print density from five levels.  
You can adjust the print density while printing is in progress.

### Important!:

- “Print Density” is not available when “Ink Saving” is selected.  
☞ p.70

### Note:

- The default print density can be set on the Admin. Screen.  
The factory default is set at level 3 (Standard).  
☞ p.167
- When **[ECO mode]** is set, the default print density is “1”.  
The print density may be adjusted while in ECO mode.  
☞ p.167 [Print Speed]  
☞ p.167 [Print Density]

Press the ◀ or ▶ key to adjust the print density.

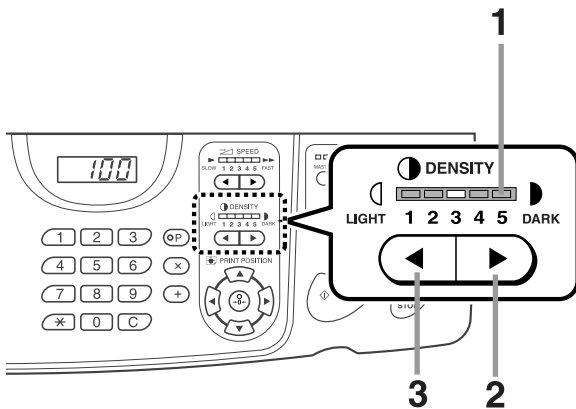

- 1) **Print Density Adjustment Indicator**  
Shows the current setting of the print density.
- 2) **▶ Key**  
Increases the print density incrementally.
- 3) **◀ Key**  
Decreases the print density incrementally.

# Adjusting the Print Position

## [Print Position Adjustment]

The print position on the paper can be adjusted.

Adjustment range Vertical direction (bottom ↔ top): ±15 mm (±19/32")

Horizontal direction (left ↔ right): ±10 mm (±25/64")

The positioning may be adjusted while printing is in progress.

**Note:**

- After adjusting the print position, print a proof copy to check the result.  
p.102
- The numerical value formed by "Print Position Adjustment" is the target. Set the actual position by verifying and adjusting the printed material.

Press the , ,  or  key to move up or down.

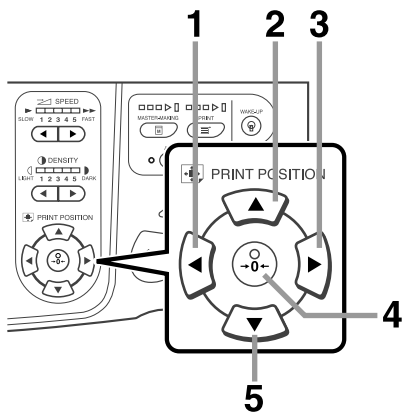

- 1)  **Key**  
Each press shifts the print position downward in steps of about 0.5 mm (1/64").

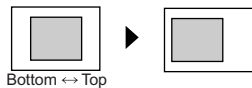

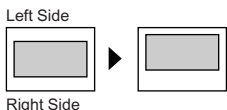

- 2)  **Key**  
Press the key to move the print image about 0.5 mm (1/64") to the left on the paper.



- 3)  **Key**  
Each press shifts the print position upward in steps of about 0.5 mm (1/64").



- 4)  **Key/Original Position Indicator**  
Press to return to original position.  
To restore the original Print Position during printing, hold the button down for more than 1 second. When the original Print Position is restored the indicator will light up.

- 5)  **Key**  
Press the key to move the print image about 0.5 mm (1/64") to the right on the paper.

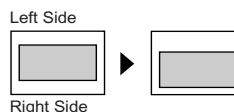

The Print Basic Screen shows current vertical/horizontal adjustment.

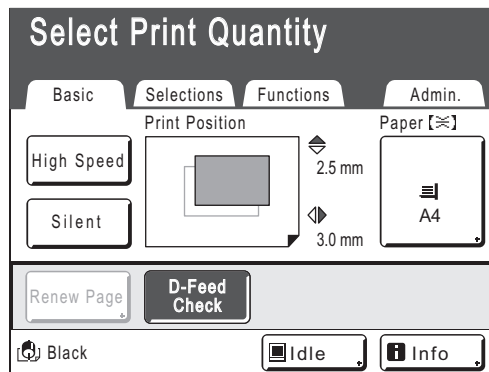

**Tip:****Making Fine Adjustments to the Print Position**

If the "Fine Adjust Mode" option is included in the machine settings, you can make detailed adjustments to the Print Position in approximately 0.1 mm ( $1/254$ "") increments (ordinary mode is 0.5 mm ( $1/64$ "")).

To use "Fine Adjust Mode" settings, please contact your dealer (or authorized service representative).

When "Fine Adjust Mode" is available, the button **[Fine Adjust Mode]** is displayed on the Functions Screen.

Touch **[Fine Adjust Mode]** to turn "Fine Adjust Mode" ON (the button is highlighted) and enable adjustment in 0.1 mm ( $1/254$ "") increments. When "Fine Adjust Mode" is OFF, adjustments will be in 0.5 mm ( $1/64$ "") increments.

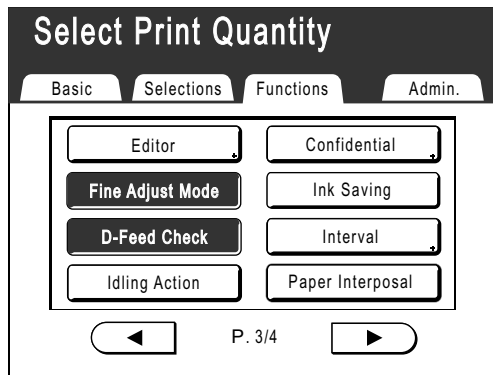

# Printing Proof Copies [Proof]

After making adjustments to the print position or density, check the print quality in a proof copy. Proof copies are not counted towards the number of copies displayed on the Print Quantity Display.

**Note:**

The machine will continue to print proof copies if the  key is held down.

Press the  key.

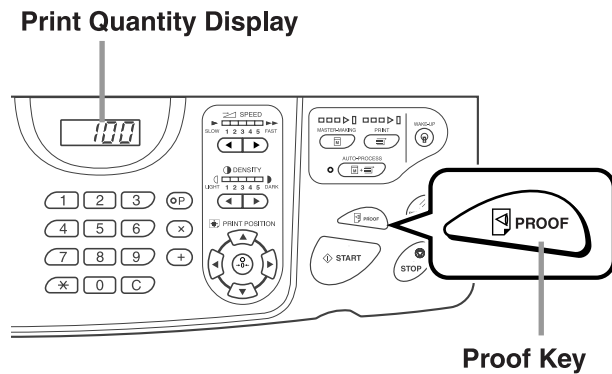

A single proof copy is printed.



# Prevent Paper Jams When Using Special Paper [D-Feed Check]

This printer monitors for multiple paper feeds. If a feed of more than one sheet is detected, the print job automatically stops and “D-Feed Check” is executed.

The multiple paper feed detector is calibrated for normal print paper. Depending on the type of paper used, double feeding may be detected and an error displayed even when one sheet of paper is properly supplied. In the following instances, please set “D-Feed Check” to “OFF”:

- When a multi-feed detection message is occasionally displayed, even though no multi-feed has occurred
- When using dark paper (black, red, dark blue)
- When using paper already printed on the back side

## Note:

- In the factory settings, “D-Feed Check” is set to “ON”.  
     ☞ p.168

## Touch [D-Feed Check] on the Functions Screen.

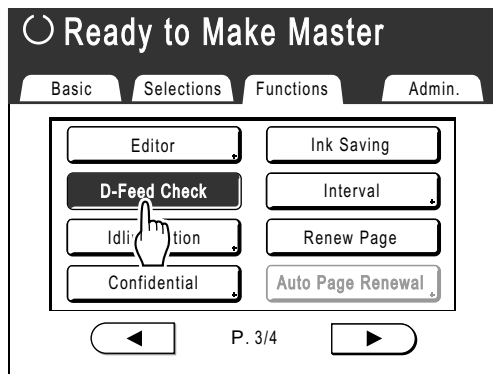

The button changes from being highlighted (b/w) to the normal display, and “D-Feed Check” is set to “OFF”.

# Extending the drying time [Interval]

A sheet of paper is normally fed and printed with each Print Drum (Cylinder) rotation, but by extending the paper feed interval, the Ink has more time to dry, which prevents Ink marks on the back of the next sheet. The paper feed interval (skip rotation) can be set from 1 - 10.

## 1 Touch [Interval] on the Functions Screen.



## 2 Touch [ON].

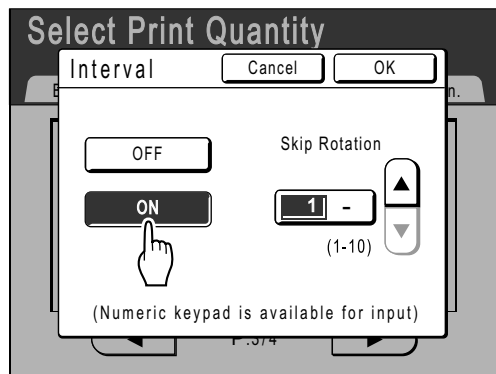

## 3 Touch ▲ or ▼ to set the number of Skip Rotations for the Print Drum (Cylinder).

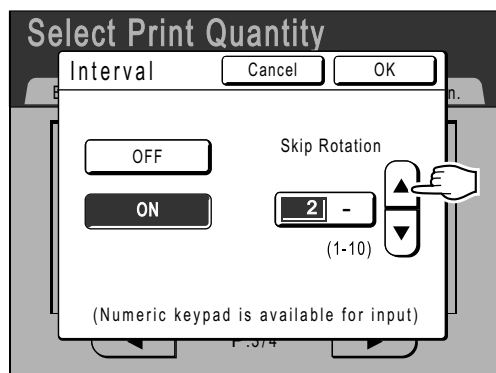

### Note:

- Print Quantity Keys can also be used to enter numbers.
- If you are using extended paper and set the Print Drum (Cylinder) skip rotation to an odd number, the actual skip rotation is the "Set Number +1".

☞ p.180

## 4 Touch [OK].

Returns to the Functions Screen. "Interval" setting is updated.

# Paper Feed/Output Settings for Special Paper and Printing Types

## [Jump Wing Control] [Special Paper Ctrl]

Paper feed and output settings can be adjusted when using special paper or uneven print finishes.

### ◆ Jump Wing Control

The following steps retrieves pre-configured custom settings for the Paper Jumping Wing. Use this feature to eject certain printing paper that is hard to eject with automatically adjusted normal Paper Jumping Wing setting.

#### Important!:

- “Jump Wing Control” feature is not available unless pre-configured.
- Only one setting can be pre-configured.
- To pre-configure or to change settings, please contact your dealer (or authorized service representative).

#### Note:

- The Paper Jumping Wing is a device which helps eject printed paper onto the Auto-control Stacking Tray or the Paper Receiving Tray. It automatically adjusts according to the position of the Paper Feed Pressure Adjustment Lever (NORMAL or CARD).

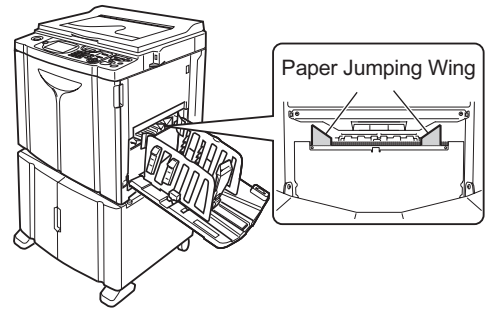

### ◆ Special Paper Ctrl

You can save settings for easy retrieval next time. The “Special Paper Ctrl” menu contains the following options:

#### Paper Feed Adj.

Adjust Paper Feed Tray position and paper-feed amount to suit special paper characteristics. For adjustment methods, please contact your dealer (or authorized service representative).

#### Paper Eject Adj

Some types of original image/paper may be printed with an uneven or blurred finish due to air blow or separation fan settings. This option can be used to change air blow and separation fan settings. For adjustment methods, please contact your dealer (or authorized service representative).

### ◆ Receive Tray (when using the optional Auto-control Stacking Tray)

The positions of the Receiving Tray Paper Guides/Stopper on the Auto-control Stacking Tray are automatically adjusted according to the paper size. Detailed adjustments to these positions can also be made using the display buttons where appropriate.

For information on adjusting the Receiving Tray Paper Guides/Stopper, see “Adjusting the Auto-control Stacking Tray” (p.112).

#### Important!:

- In cases where the Receiving Tray Paper Guides/Stopper are not raised, adjustments cannot be made to the Auto-control Stacking Tray.

## Setting the Jump Wing Control [Jump Wing Control]

---

Touch [Jump Wing Control] on the Functions Screen.



"Jump Wing Control" is selected.

# Saving Settings and Renaming the Parameter Names in the Parameter List

**1 Touch [Special Paper Ctrl] on the Functions Screen.**

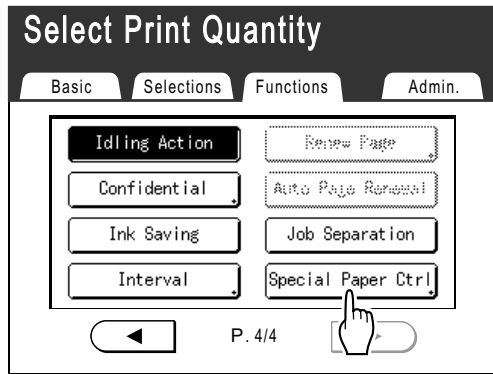

**2 Adjust [Paper Feed Adj.] and [Paper Eject Adj].**

**Note:**

- For details of adjustments, see p.105.

**3 Confirm the adjustments on the Special Paper Ctrl Screen.**

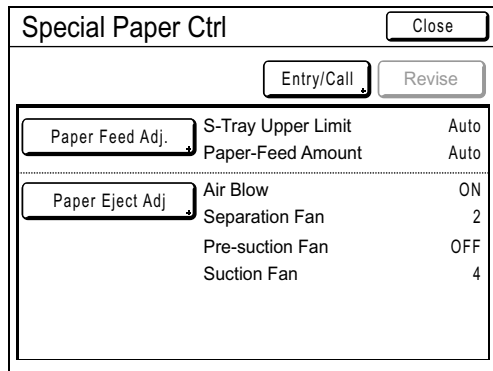

**4 Touch [Entry/Call].**

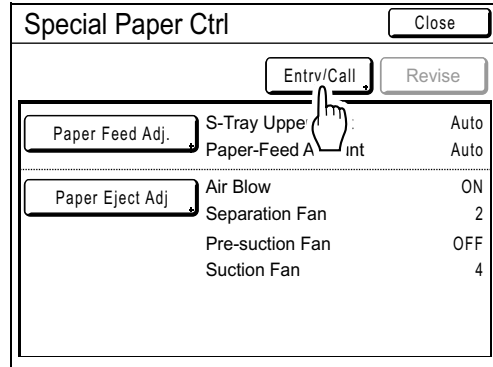

Parameter List Screen is displayed.

**5 Touch an unused button.**

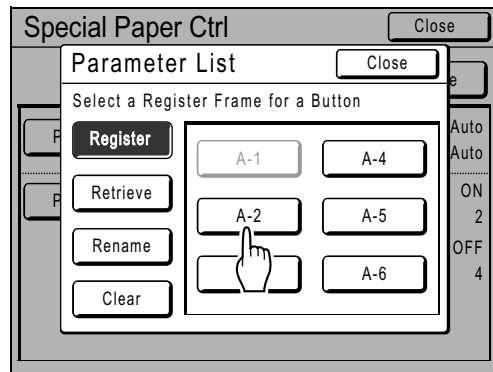

Unused buttons are displayed with a solid line. Used buttons are grayed out and are not available.

**6 Touch [OK].**

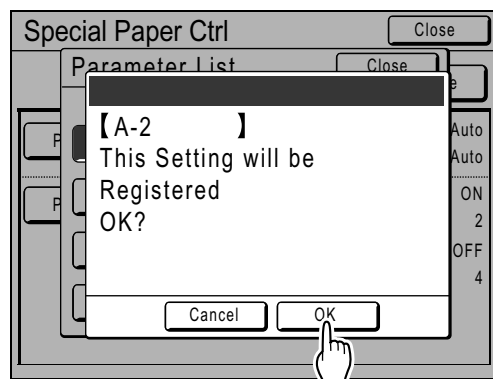

Returns to the Parameter List after the settings have been saved.  
 The name of each parameter can be changed for your convenience. To change parameter names, proceed to the next step.

**Note:**

- After saving the settings, touch [Close] on the Parameter List Screen to return to the Special Paper Ctrl Screen.
- Touch [Close] on the Special Paper Ctrl Screen to return to the Functions Screen. Printing will be done with the saved settings.
- If you do not wish to print after saving the settings, press  key on the control panel.

**7 Touch [Rename].**

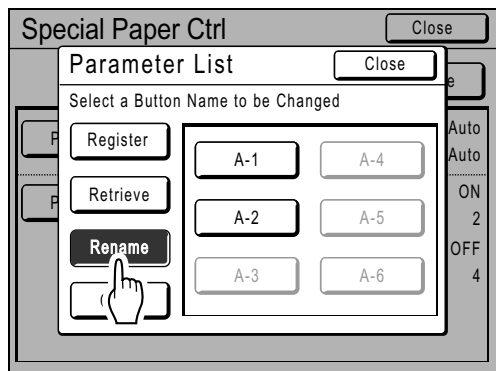

**8 Touch the button to rename.**

Unregistered buttons are grayed out and are not available.

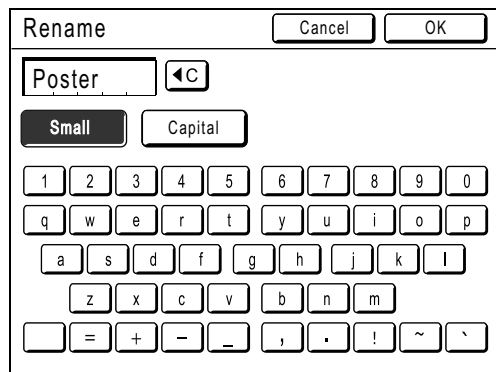

**9 Touch character buttons to enter a new name.**



Change capitalization by selecting [Small] or [Capital] button.

 p.136

**Note:**

- To delete the current name, touch  button or press the  key.

**10 Touch [OK] after entering all the characters.**

Returns to the Parameter List Screen and the name is updated.

**11 Touch [Close].**

Returns to the Special Paper Ctrl Screen.

# Retrieving Settings from the Parameter List

**1 Touch [Special Paper Ctrl] on the Functions Screen.**

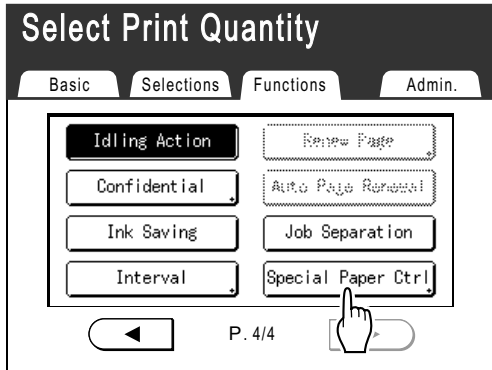

**2 Touch [Entry/Call].**

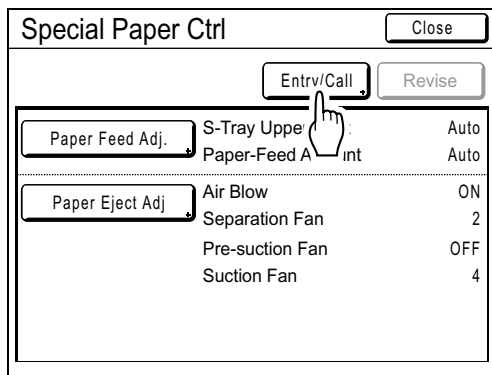

Display the Parameter List Screen.

**3 Touch [Retrieve].**

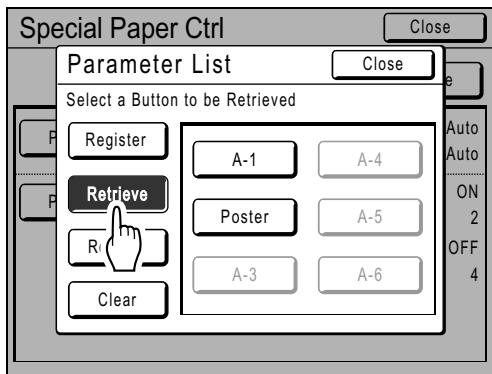

**4 Touch the button to retrieve.**

Unregistered buttons are grayed out and are not available.

Returns to the Special Paper Ctrl Screen and the desired setting is retrieved.

Confirm the settings made.

**Note:**

- Repeat steps 2 to 4 to retrieve other settings.

**5 Touch [Close].**

Returns to the Functions Screen and the settings are updated.

After this, follow the same operations for normal printing.

## Making changes to Special Paper Ctrl Setting

### 1 Display the Parameter List Screen.

Follow steps 1 to 2 (p.109).

### 2 Touch [Retrieve].

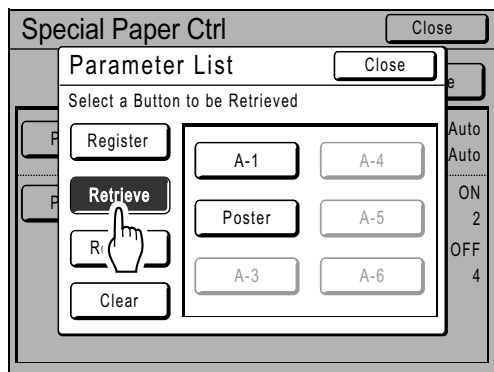

### 3 Touch the button to change.

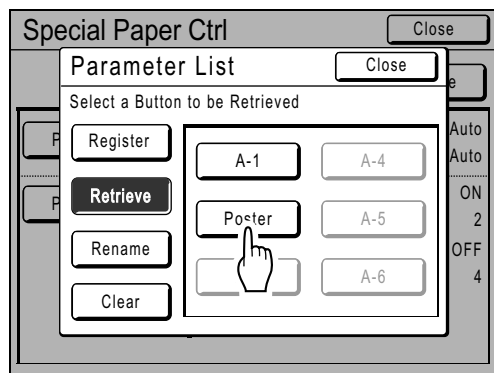

### 4 Change the setting parameters.

Parameters for the following can be changed: "Paper Feed Adj." and "Paper Eject Adj".

**Note:**

- For details of changes, see p.105.

### 5 Touch [Revise] on the Special Paper Ctrl Screen.

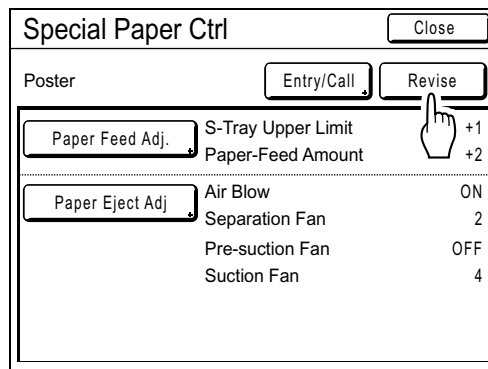

### 6 Touch [OK].

Returns to the Special Paper Ctrl Screen after parameters have been revised.



# Clearing Special Paper Ctrl Settings

## 1 Display the Parameter List Screen.

Follow steps 1 to 2 (p.109).

### Important!:

- First, check whether the setting can be cleared. (Retrieve the appropriate setting and follow the steps beginning with step 2.)
- Cleared settings cannot be recovered.

## 2 Touch [Clear].

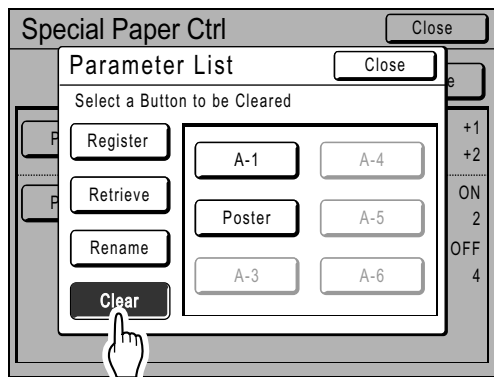

## 3 Touch the button to clear.

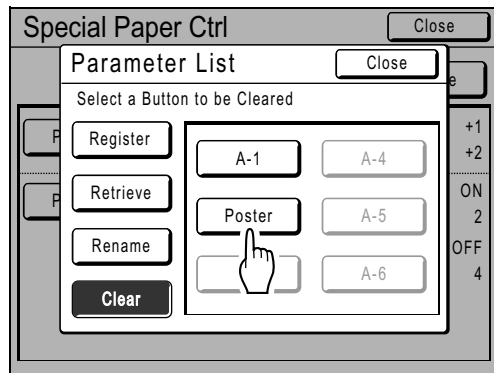

Unregistered buttons are grayed out and are not available.

## 4 Touch [OK].

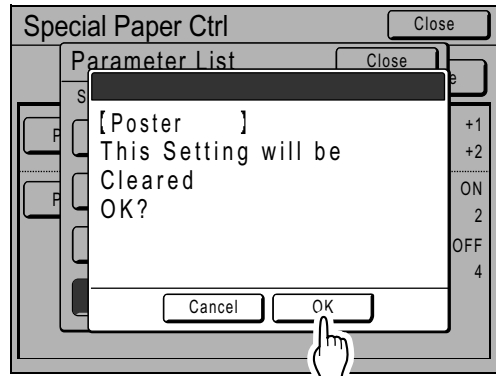

Returns to the Parameter List Screen. The selected setting is cleared.

## 5 Touch [Close].

Returns to the Special Paper Ctrl Screen.

# Adjusting the Auto-control Stacking Tray (when using the optional Auto-control Stacking Tray) [Receive Tray]

**1 Touch [Special Paper Ctrl] on the Functions Screen.**

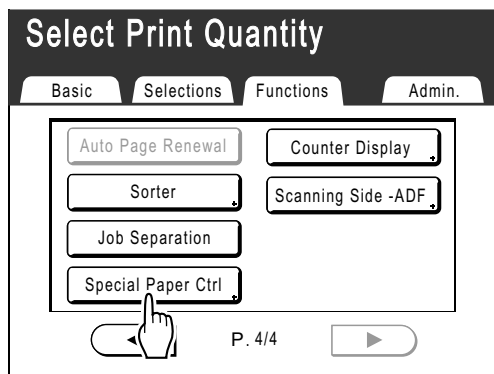

**2 Touch [Receive Tray].**

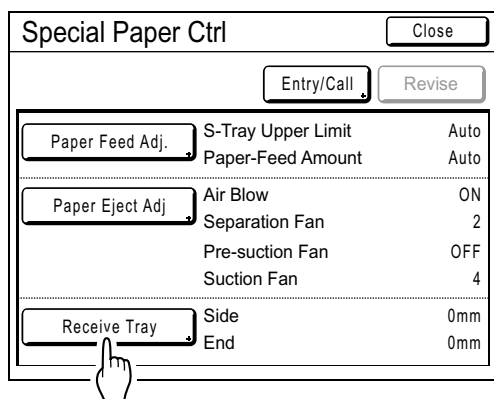

**3 Touch the relevant adjustment buttons.**

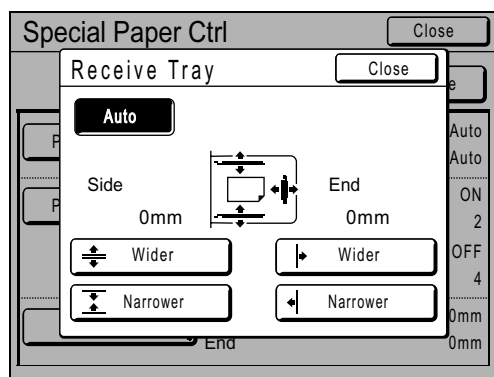

◆ **Automatic adjustment of the Receiving Tray Paper Guides/ Stopper**

Touch **[Auto]** to adjust the position of the Receiving Tray Paper Guides/Stopper automatically to the standard positions for the paper size.

◆ **Detailed adjustments of the Receiving Tray Paper Guides/ Stopper**

Touch either one of the four “Narrower” or “Wider” buttons to move the Receiving Tray Paper Guides/Stopper in approximately 0.5 mm (1/64”) increments.

- The adjustment value for the Receiving Tray Paper Guides is displayed under “Side”, while the Stopper adjustment is displayed under “End”.
- Detailed adjustments will be effective after paper size is set.
- Touch **[Auto]** to reset both “Side” and “End” to the default value of 0 mm (0”) and reactivate automatic adjustment.

**Note:**

- The Receiving Tray Paper Guides (side) can be widened by pressing the Receiving Tray Paper Guides’ Opening Button during printing. (p.22)

**Buttons, components activated and direction of movement**

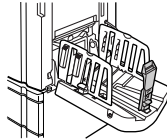
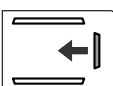
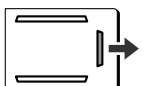
Button	Activated component	Direction
[ ◀ Narrower ]	Stopper 	Towards the machine 
[ ▶ Wider ]		Outwards on the Auto-control Stacking Tray 

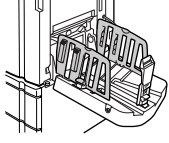
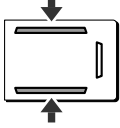
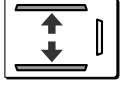
Button	Activated component	Direction
[Narrower]	Receiving Tray Paper Guides 	Inwards on the Auto-control Stacking Tray 
[Wider]		Outwards on the Auto-control Stacking Tray 

**Note:**

- Settings can be saved in “Special Paper Ctrl”, for easy retrieval next time.   
☞ p.107

**4 Touch [Close].**

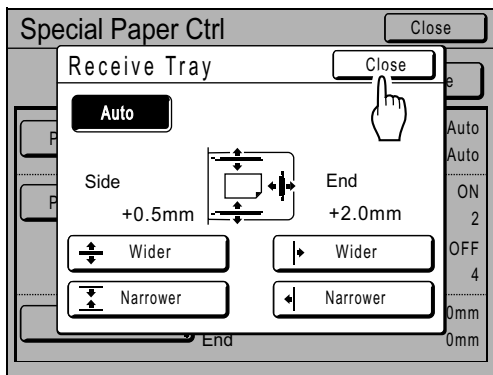

Returns to the Special Paper Ctrl Screen.

**5 Touch [Close].**

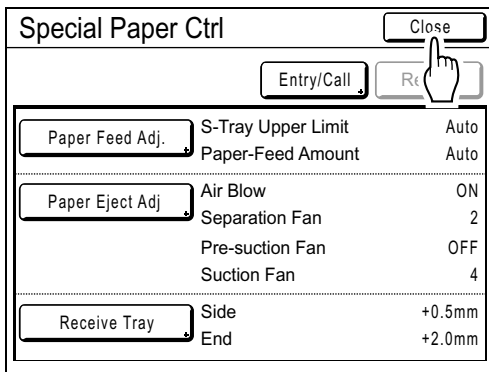

Returns to the Functions Screen.  
You can go back to normal printing processes.

# Advanced Features

## Setting Up User Management [User Management]

### Functions of User Management

---

This machine is equipped with a User Management function to ensure security and enhance user management. The User Management function has 3 Management Levels. The following features are available according to the level.

Feature	Management Level		
	High/Full Management	Mid/ID Print Only	Low/Admin tab Only
<b>[ID Counter Report]</b> for managing the number of prints/masters. <a href="#">p.160</a>	Available	Available For ID print only	Not Available
<b>[Limit]</b> for setting the upper limit of the number of copies/masters per user set. <a href="#">p.123</a>	Available	Available	Not Available
<b>[ID Print]</b> for printing data sent from PC. <a href="#">p.52</a>	Available	Available	Not Available
<b>[My Direct Access]</b> for registering the frequently-accessed functions displayed in the Direct Access Area. <a href="#">p.164</a>	Available	Not Available	Not Available
Saving scanned originals for <b>[ID Print]</b> . <a href="#">p.52</a>	Available	Not Available	Not Available
Allowing only the administrator to change the <b>[Admin.]</b> settings. <a href="#">p.166</a>	Available	Available	Available

All users must be registered to manage the machine at the High/Full Management level. Also, users must input a PIN Code (or connect a registered USB Flash Drive) to use the machine.

This section explains settings for using the User Management function and how to make those settings set by the Administrator.

### Management Level and Access Timing of User Identification Access

When “Management Level” is set to “High/Full Management” or “Mid/ID Print Only”, the users will be asked to identify themselves (“User identification access”) during operations. The Recognition and Identification System can be selected from either “PIN Code” or “USB Flash Drive” which is set by the administrator in advance.

	When Operating the Machine	When Outputting the ID Print
High/Full Management	<p>User identification access is required</p>	<p>User identification access is not required</p>
Mid/ID Print Only	<p>User identification access is not required</p>	<p>User identification access is required</p>
Low/Admin tab only	<p>User identification access is not required</p>	<p>ID Print cannot be performed</p>

### User Management Options

To activate the User Management function, the administrator must set up User Management. The setting options of User Management and details are explained below.

#### ◆ “Recognized by” (☞ p.117)

Select the Recognition and Identification System.

**PIN Code:** When user identification access is required, input the PIN Code.

Set up to 8 digits for each user in “Create User”.

**USB Flash Drive:** When user identification access is required, connect the registered USB Flash Drive to the USB slot. Prepare the number of USB Flash Drives for the individual users and register them with the machine.

**OFF/Delete:** Delete the information registered in User Management (administrator/user registration included), and return to the factory settings.

#### Important!:

- If the “Recognized by” setting is changed, all settings in User Management, including the administrator’s registration, will be deleted. Set “Recognized by” first, then operate other settings.

#### ◆ “Management Level” (☞ p.119)

Select the Management Level from among 3 levels.

**High/Full Management:** Users require identifying themselves when operating the machine and when the ID Print is output.

**Mid/ID Print Only:** Users require identifying themselves when the ID Print is output.

**Low/Admin tab only:** Manages the users without any use of security features. Users don’t require identifying themselves when operating the machine and cannot perform ID print. This level allows only the administrator to change the [Admin.] settings.

For details, see the table of ☞ p.114.

◆ **Create User (☞ p.120)**

Register the administrator/users.  
Up to 100 users (administrator included) can be registered.  
Set following options when registering.

- **PIN Code or USB Flash Drive**  
**PIN Code:** A PIN Code can be set for user identification access.  
We recommend that you prepare a list of the registered users and record the user registration numbers (ID) and PIN Codes for each user.  
Notify each user about the set PIN Code and user registration number (ID).  
**USB Flash Drive:** A USB Flash Drive can be set for user identification access.  
We recommend that you record which USB Flash Drives you distribute to which user.  
Distribute to each user a registered USB Flash Drive and a user registration number (ID).
- **Rename**
- **Group:** User groups can be set.
- **Limit:** The upper limit of the copies/masters can be set.
- **Disable:** User identification access can be enabled or disabled.

Registered settings can be changed or cleared.

In order to register users or operate other settings in User Management, the administrator must be registered in advance. The User Management functions are activated after registering the administrator.

◆ **Rename Group (☞ p.127)**

Set a group name when operating group management.  
Up to 32 groups can be registered.

◆ **Reset Counter (☞ p.128)**

Clear the usage counters of all users and groups.

## Operation flow of User Management

---

We recommend that you set up User Management in following order.

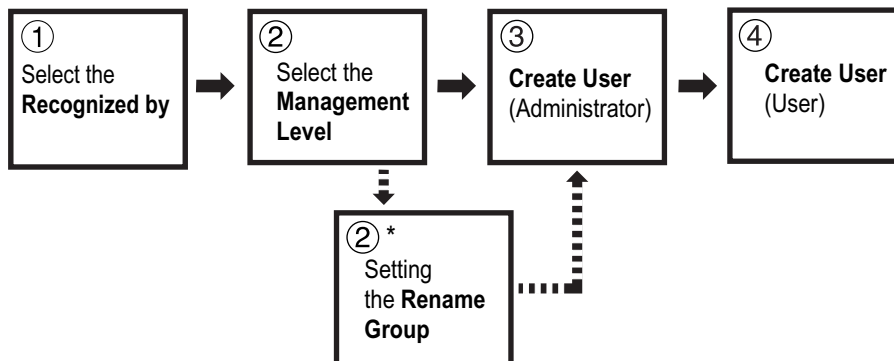

\*Set when you want to count user usage by group using “ID Counter Report”. See ☞ p.160.

## Selecting Recognition and Identification System

Set the Recognition and Identification System using “Recognized by” in advance when setting up User Management.

### Important!:

- If “Recognized by” is changed, all settings in User Management, including the administrator’s registration, will be cleared.

### 1 Touch [Admin.] on the Basic Screen for each mode.

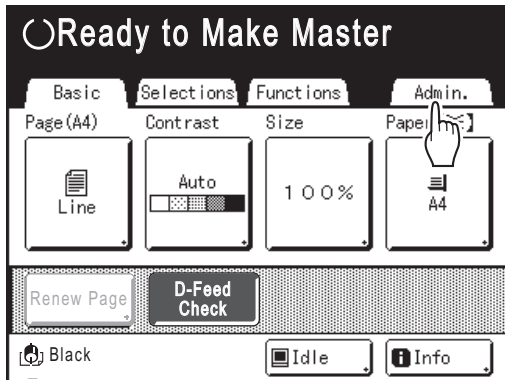

### 2 Touch [OK].

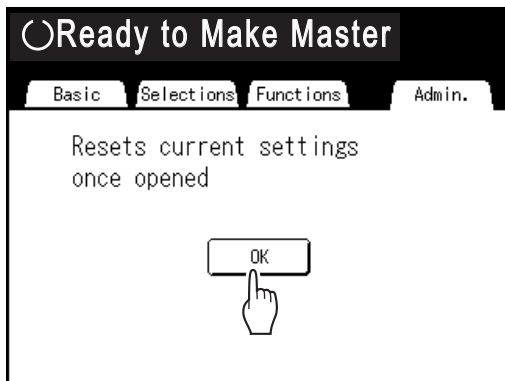

Skip to step 4 if the administrator is not registered. If the administrator is already registered, the Recognition Screen is displayed here. See step 3.

### 3 Identify the administrator.

#### ◆ When “Recognized by” is set to “PIN Code”

Input the administrator’s PIN Code.



#### ◆ When “Recognized by” is set to “USB Flash Drive”

Connect the administrator’s registered USB Flash Drive to the USB slot.



### 4 Touch [User Management].

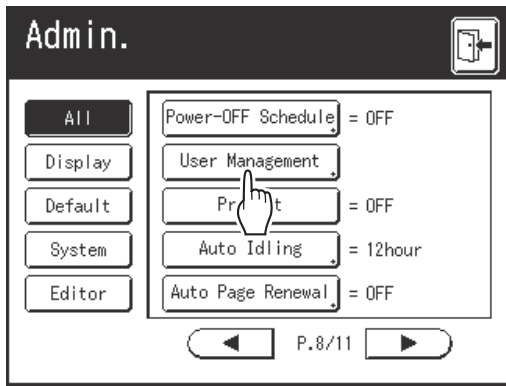

### 5 Touch [Recognized by].

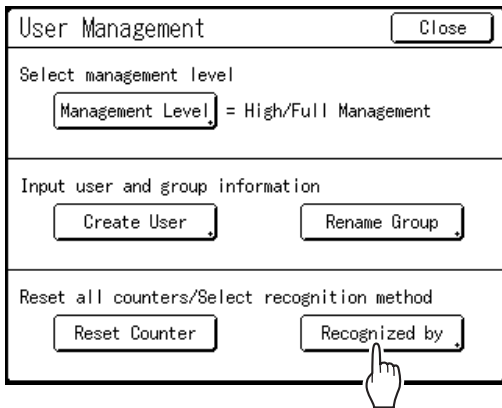

### 6 Touch the button to select the “Recognized by” option.

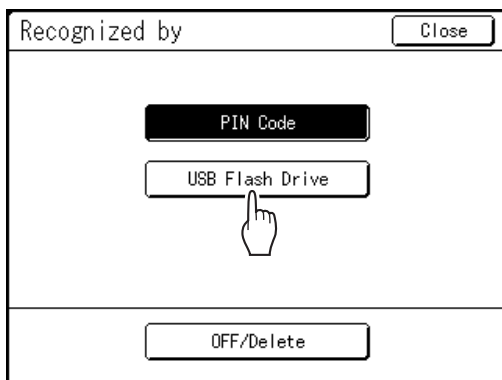

**Note:**

- If you touch **[OFF/Delete]**, all settings set in User Management will be deleted and returned to the factory settings.

### 7 Touch [OK].



Returns to the User Management Screen. “Recognized by” is updated.

Continue User Management settings. See the subsequent pages.



# Setting Up the Management Level

## Important!:

- Set “Recognized by” in advance.  
     ☞ p.117

## 1 Display the User Management Screen.

Follow steps 1 to 4 in “Selecting Recognition and Identification System” (☞ p.117).

## 2 Touch [Management Level].

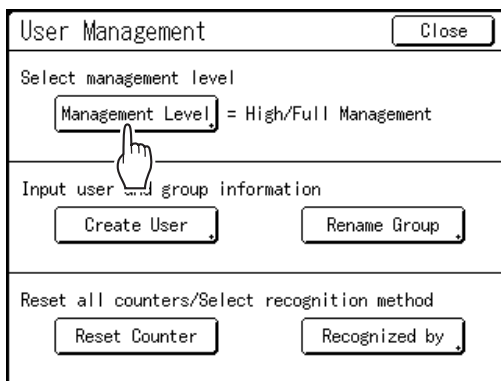

## 3 Touch the button to select the “Management Level” option.

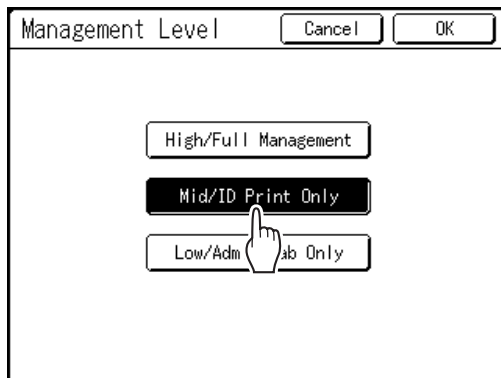

See ☞ p.114 for details about Management Level options.

## 4 Touch [OK].

Returns to the User Management Screen. “Management Level” is updated.

You can continue registering users and renaming groups if needed.

To close the User Management settings, touch **[Close]** on the User Management Screen to return to the Admin. Screen.

## Registering Administrator/Users

In order to activate the User Management function, the administrator must be registered. Up to 100 users can be registered (administrator included).

**Note:**

- The user registration number (ID) is required when operating “ID print” from the printer driver.

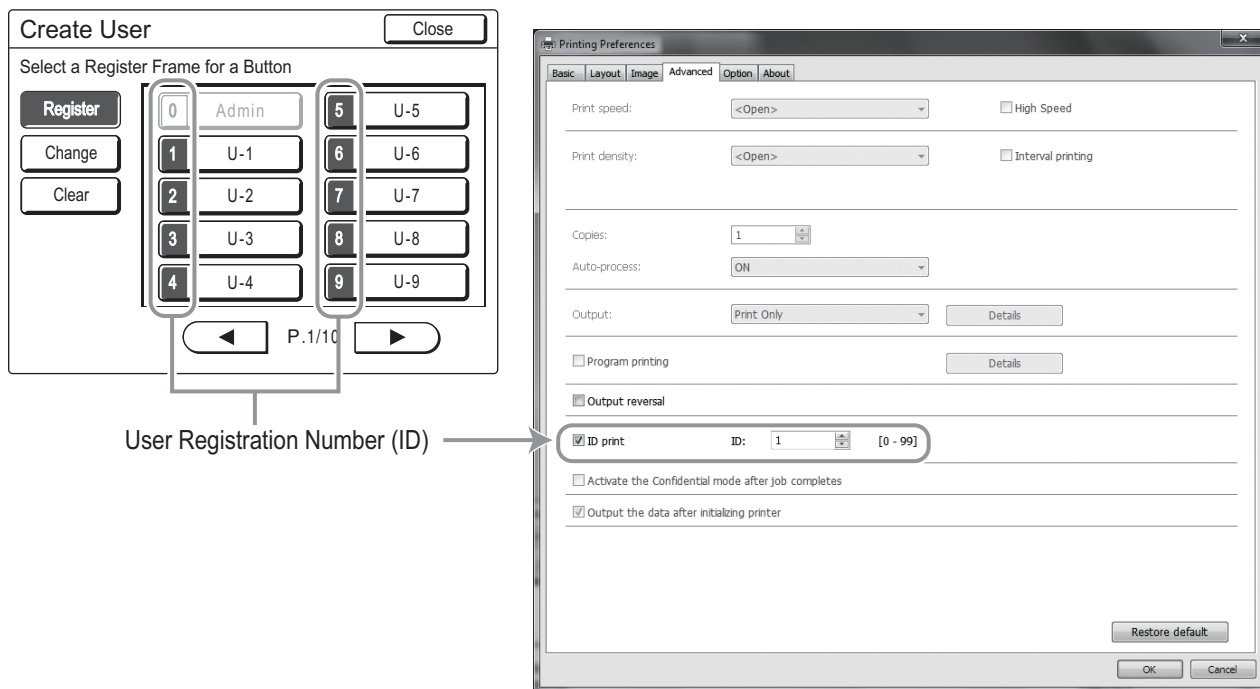

◆ Basic operation for registering administrator/users

**1 Display the User Management Screen.**

Follow steps 1 to 4 in “Selecting Recognition and Identification System” (p.117)

**Important!:**

- Set “Recognized by” in advance.
- If you set the group to assign, we recommend that you set “Rename Group” first. (p.127)

**2 Touch [Create User].**

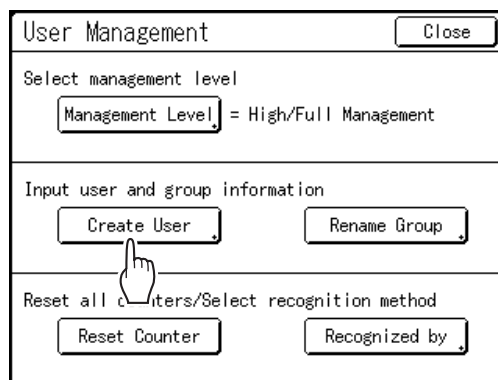

### 3 Touch an unused button.

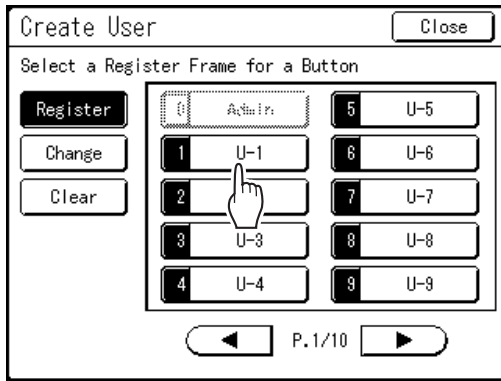

Unused buttons are displayed with a solid line. Used buttons are grayed out and are not available. (Another user has been registered.)

#### Important!:

- Be sure to register the administrator first.
- If the administrator is not registered, buttons are not available except “0 Admin”.
- The “0” button is only available to the administrator. Even if you rename this button, it will be treated as the administrator.

### 4 Input the PIN Code or connect the USB Flash Drive.

#### ◆ When “Recognized by” is set to “PIN Code”

Input the PIN Code using the Print Quantity Keys.

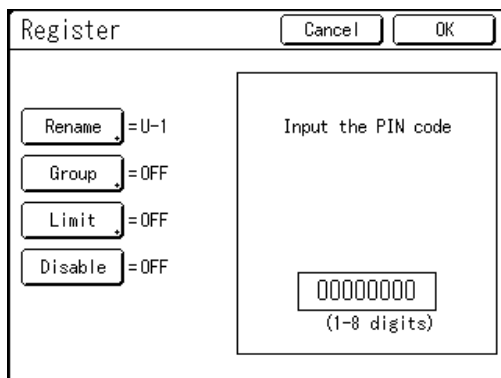

Up to 8 digits can be input.  
Press the **C** key to clear the PIN Code.

#### ◆ When “Recognized by” is set to “USB Flash Drive”

Connect the registered USB Flash Drive to the USB slot.

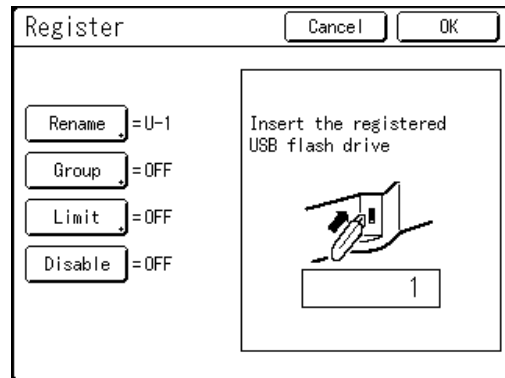

The number that identifies the registered USB Flash Drive is displayed.

#### Note:

- If you register multiple USB Flash Drives, we recommend that you ready them to be distinguished later (for example, put a user name on the USB Flash Drive).
- If you input the assigned PIN Code (“Recognized by”: PIN Code) or connect the USB Flash Drive that you already registered (“Recognized by”: USB Flash Drive), the following message is displayed when touching [OK].

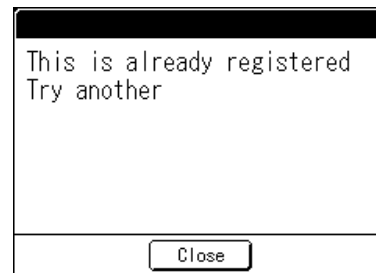

Touch **[Close]** and input the unassigned PIN Code or connect the unregistered USB Flash Drive.

### 5 Set various settings.

Do the following settings if needed.

- Rename (p.122)
- Group (p.123)
- Limit (p.123)
- Disable (p.124)

## 6 Touch [OK].

Returns to the Create User Screen.  
The administrator or the user is registered.  
To register multiple users, touch **[Register]** and repeat steps 3 to 6.

## 7 Touch [Close].

Returns to the User Management Screen.  
You can continue registering users and renaming groups if needed.

To close the User Management settings, touch **[Close]** on the User Management Screen to return to the Admin. Screen.

## ◆ Enter the User Name

### 1 Touch [Rename] on the Register Screen.

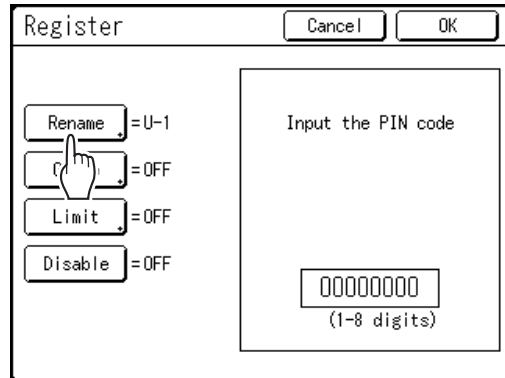

### 2 Touch the character buttons to enter a new name.

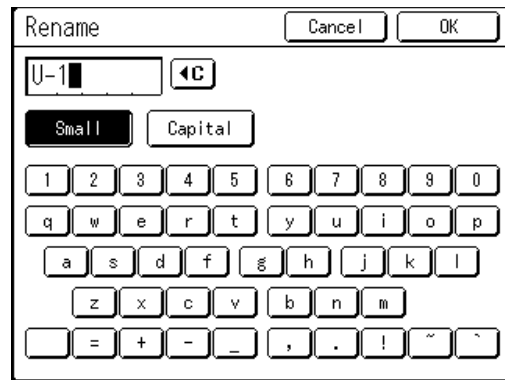

Change capitalization by selecting the **[Small]** or **[Capital]** button.

☞ p.136

#### Note:

- To clear the current name, touch **[Clear]** button or press the **[C]** key.

### 3 Touch [OK].

Returns to the Register Screen.  
The user name is renamed.

### ◆ Setting the Group to assign

When you set up a group by user, user usage can be counted by group.

☞ p.160

It is recommended to enter the group name in advance.

☞ p.127

#### 1 Touch [Group] on the Register Screen.

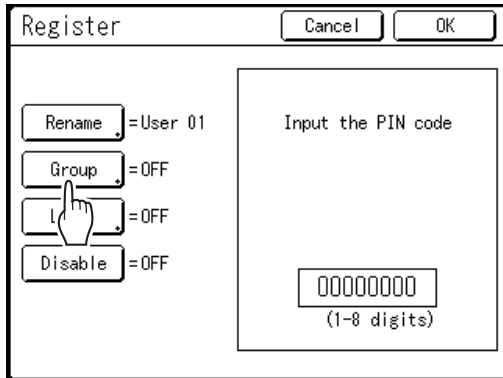

#### 2 Touch the Group button to set.

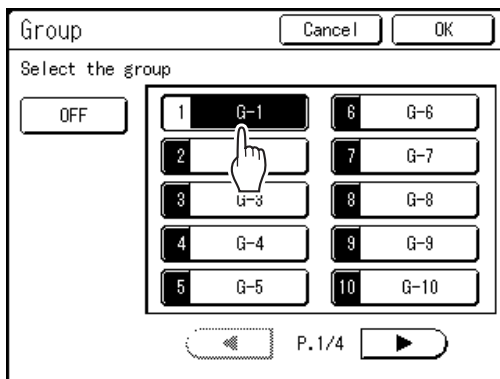

#### Note:

- If you are not setting up a group, touch [OFF].
- Set "Rename Group" if needed.  
☞ p.127

#### 3 Touch [OK].

Returns to the Register Screen.

The user is assigned to the group that you have set.

### ◆ Setting the Upper Limit of the User's Usage

Set the upper limit of the number of copies/masters. Up to 99,999,999 can be set.

The present copy count and master count can also be cleared on the same screen.

#### 1 Touch [Limit] on the Register Screen.

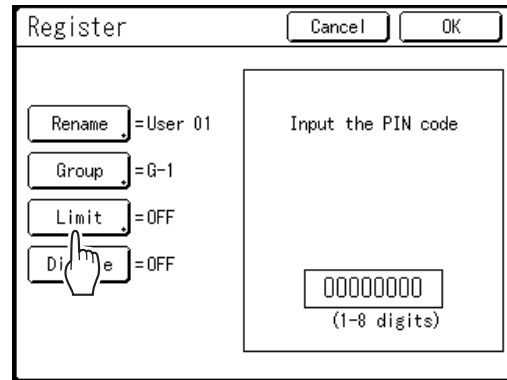

#### 2 Touch the limit input box and enter the upper limit number using the Print Quantity Keys.

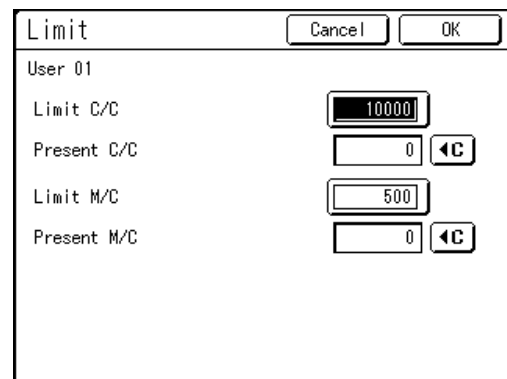

C/C: Copy Count  
M/C: Master Count

#### Note:

- To clear the number, press the **C** key.
- "Present C/C" and "Present M/C" show the current amount of copies and masters that the user used.
- To clear the "Present C/C" and "Present M/C", touch each **C** button.

#### 3 Touch [OK].

Returns to the Register Screen.

"Limit" is updated.

◆ **Disabling User identification access**

**Touch [Disable] on the Register Screen to turn it “ON”.**

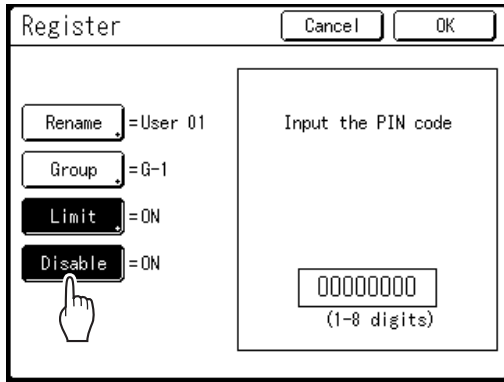

User identification access is disabled and the user cannot use the machine.

**Note:**

- To inactivate “Disable”, touch **[Disable]** to turn it “OFF”.
- On the Register Screen for the administrator, a **[Disable]** button is not available.

## Changing Administrator/User Registration

### 1 Display the User Management Screen.

Follow steps 1 to 4 in “Selecting Recognition and Identification System” (p.117)

### 2 Touch [Create User].

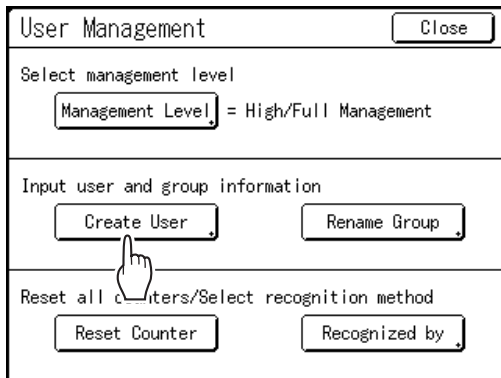

### 3 Touch [Change].

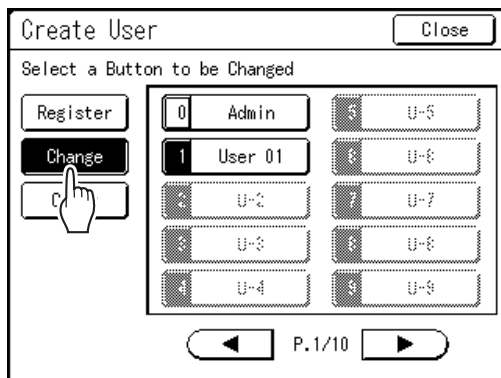

### 4 Touch the User Button to change.

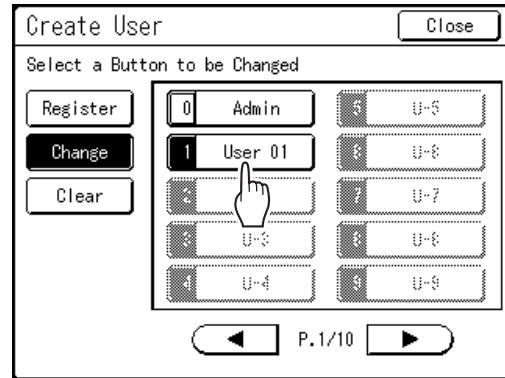

Registered buttons are displayed with a solid line. Unregistered buttons are grayed out and are not available.

### 5 Change various settings.

Follow steps 4 to 5 in “Basic operation for registering administrator/users” (p.120).

### 6 Touch [OK].

Returns to the Create User Screen. Registered setting is updated.

### 7 Touch [Close].

Returns to the User Management Screen.

To close the User Management setting, touch **[Close]** on the User Management Screen to return to the Admin. Screen.

# Clearing User Registration

## 1 Display the User Management Screen.

Follow steps 1 to 4 in “Selecting Recognition and Identification System” (p.117)

## 2 Touch [Create User].

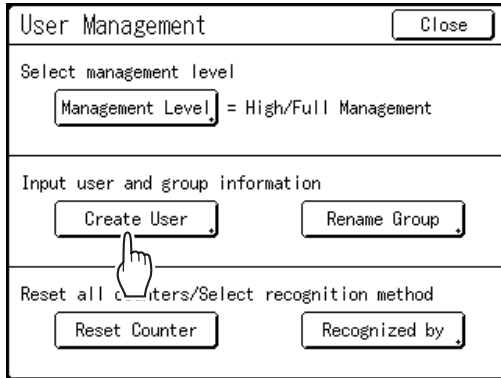

### Important!:

- Once the user registration is cleared, it cannot be recovered.

## 3 Touch [Clear].

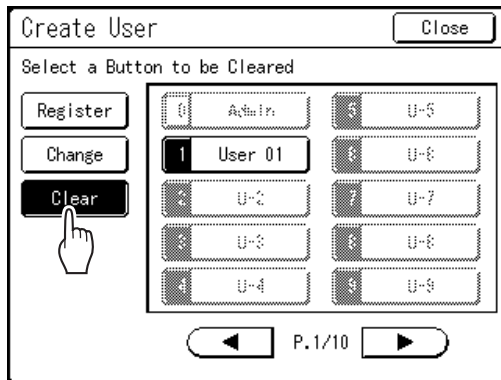

## 4 Touch the User Button to clear.

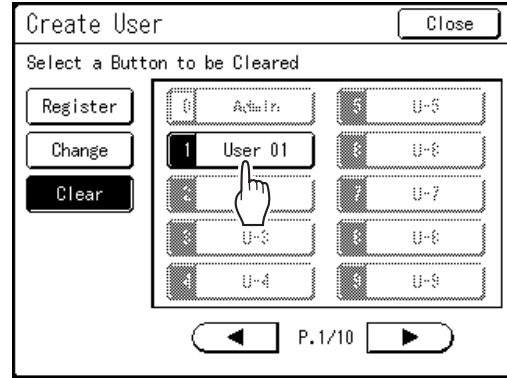

Registered buttons are displayed with a solid line. Unregistered buttons and “0 Admin” button are grayed out and are not available.

## 5 Touch [OK].



Returns to the Create User Screen. The setting of the selected user is cleared.

## 6 Touch [Close].

Returns to the User Management Screen.

To close the User Management setting, touch **[Close]** on the User Management Screen to return to the Admin. Screen.



## Renaming Groups

### 1 Display the User Management Screen.

Follow steps 1 to 4 in “Selecting Recognition and Identification System” (p.117)

### 2 Touch [Rename Group].

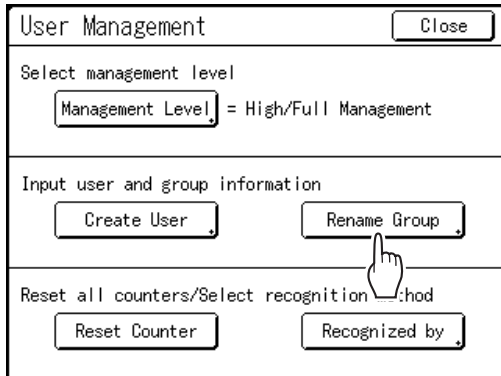

### 3 Touch the Group button to rename.

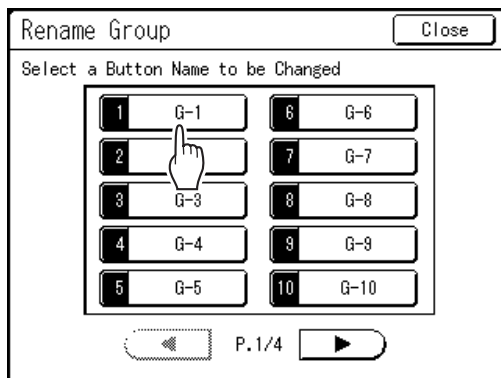

### 4 Touch the character buttons to enter a new name.

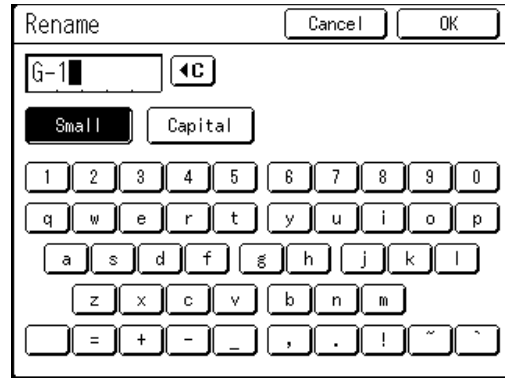

Change capitalization by selecting the **[Small]** or **[Capital]** button.

p.136

#### Note:

- You can enter up to 10 characters.

### 5 Touch [OK].

Returns to the Rename Group Screen.  
The group name is renamed.

### 6 Touch [Close].

Returns to the User Management Screen.

To close the User Management setting, touch **[Close]** on the User Management Screen to return to the Admin. Screen.

# Reset All User Counters

All user counters can be cleared in a single procedure.

**Important!:**

- After the counters are cleared, they cannot be recovered.

## 1 Display the User Management Screen.

Follow steps 1 to 4 in “Selecting Recognition and Identification System” (p.117)

## 2 Touch [Reset Counter].

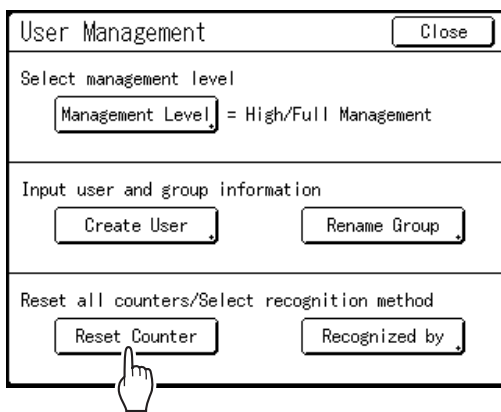

## 3 Touch [OK].

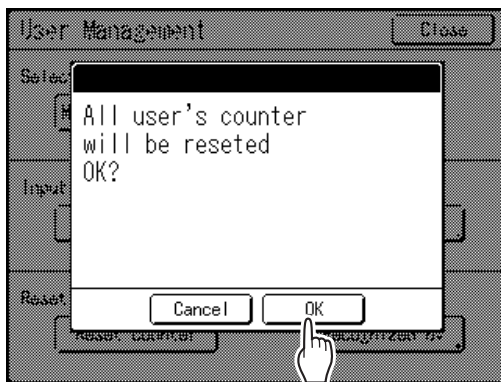

Returns to the User Management Screen.  
All user counters are cleared.

To close the User Management settings, touch **[Close]** on the User Management Screen to return to the Admin. Screen.

# Automatic Sorting Into Groups [Program]

“Program” feature saves you from repeatedly having to enter how many copies to print, by assigning the number of copies per sets in advance. Operation stops after printing each set of copies.

Store a “Program” setting for easy retrieval later.

Sample usage for this feature: in a school setting, you can pre-assign the number of copies (sheets) per class (set), and then assign the number of classes per grade (group) in the entire school.

“Program” consists of two types: “Single” and “Multiple”.

## Important!:

- “Program” is not available when “Auto Page Renewal” is selected.

## ◆ Single Page Mode

From a single original document, print into multiple groups of sets.

A maximum of 150 groups can be created, each having up to 99 sets. Each set can be up to 9999 copies.

The machine can be configured to specify how many copies (sheets) per set, then how many sets are to be created for each group.

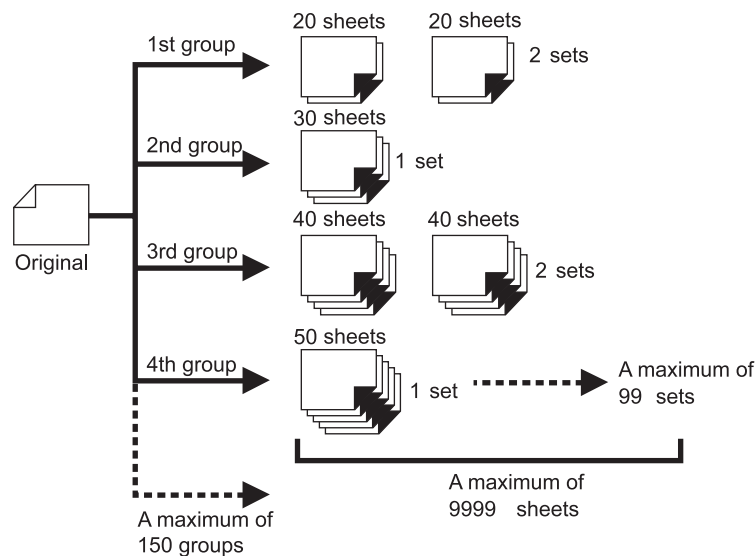

## Note:

- If you are printing multiple originals with “Single Page” program, place multiple originals (up to 50) in the optional ADF unit, and as long as “Auto Process” is “ON”, the set program can be repeated and all originals are divided into groups to print the number of copies specified.

◆ **Multi-Page Mode**

For multiple originals, different number of copies are printed for each original.

Up to 9999 copies can be made from a single original.

Each original can reproduce a pre-assigned number of sheets (up to 20 originals).

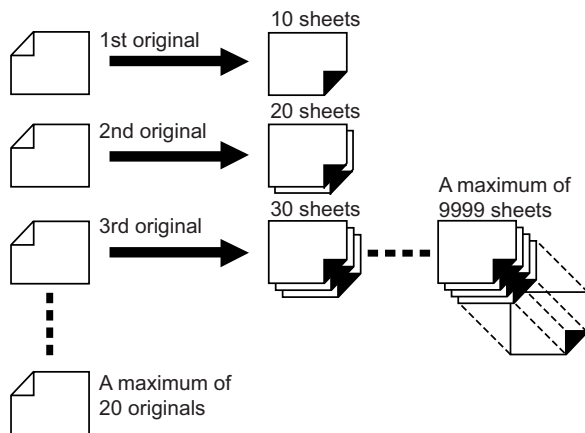

**Note:**

- This function cannot be used for printing from computer data (direct print).

☞ p.48

## How to Program Print

There are two ways to print in sets using “Program” printing feature.

- Program, then print (without saving the settings) [p.132](#)
- Retrieve a saved program, then print (when program is registered) [p.137](#)

Choose from the following actions on the Print Basic Screen.

Touch a button to proceed.

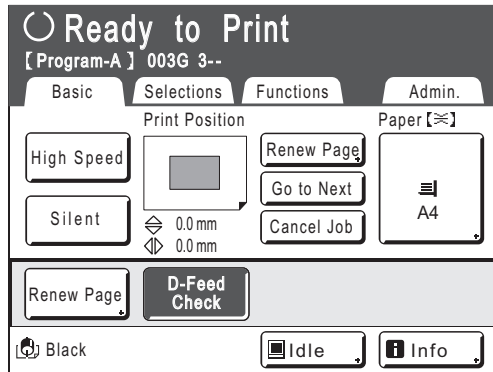

**[Renew Page]:** Creates a master from the last Master-Making data.

**[Next Page]** or **[Go to Next]:** Stops current print job, skips to the next original, set or group.

**[Cancel Job]:** Cancels execution of the Program.

### Note:

- The optional Job Separator is useful for Programed Printing.  
The Job Separator releases a piece of tape after each set or original document, thereby automatically separating sets or groups. It eliminates the need to manually remove a stack of sheets or insert a marker between sets. Remember to activate “Job Separation” in the Functions Screen when printing with the Job Separator. You must remove each stack from the Paper Receiving Tray, or insert a marker during the pause if not using the Job Separator.

# Setting Up for Programed Printing

There are two ways to display the Program Screen.

- Touch **[Program]** on the Functions Screen on the display.
- Press the **(OP)** key of the Print Quantity Keys.

The following steps describe pressing the **(OP)** key of the Print Quantity Keys.

## 1 Press the **(OP)** key.

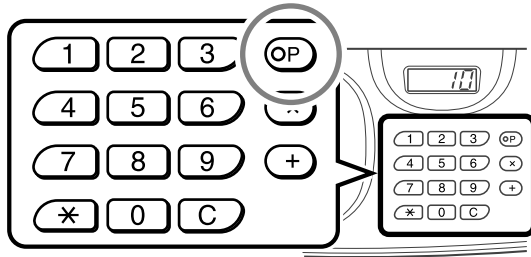

**Note:**

- Press the **(x)** key and skip to step 3 of the “Single Page Mode”. Press the **(+)** key and skip to step 3 of the “Multi-Page Mode”.

## 2 Touch **[Single]** or **[Multiple]**.

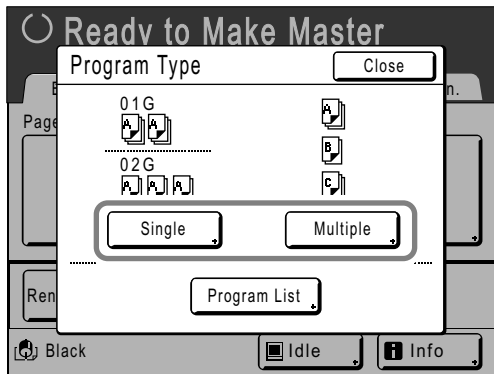

## 3 Enter the numbers using the Print Quantity Keys.

### ◆ For Single Page Mode

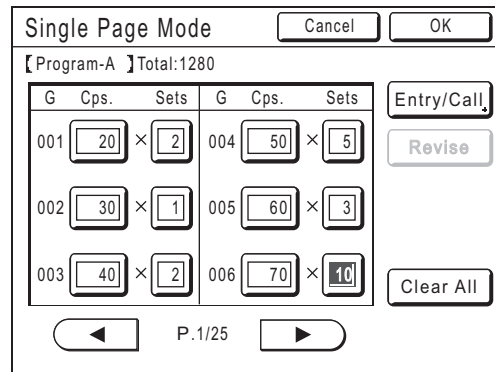

- 1) Enter the number of copies using the Print Quantity Keys.
- 2) Press the **(x)** key or the **(\*)** key.
- 3) Enter the number of sets (in the group) using the Print Quantity Keys.
- 4) Press the **(+)** key or the **(\*)** key.

To program more than one group, repeat steps 1) - 4).

**Note:**

- To cancel or change a number, press the **(C)** key and enter again.
- To clear all (number of copies and number of sets), touch **[Clear All]**.
- The total number of all copies to be printed is shown on the top of the screen.

**Important!:**

- To save the current Programed Printing settings, touch **[Entry/Call]**.  
Once **[OK]** is touched, the setting cannot be saved. See “Saving Programs” (p.134) for further information.

**◆ For Multi-Page Mode**

Multi-Page Mode		Cancel	OK
【Program-B】Total:21			
Cps.	Cps.	Entry/Call	
Page01	Page04	Revise	
Page02	Page05		
Page03	Page06	Clear All	
P.1/4			

- 1) Enter the number of copies using the Print Quantity Keys.
- 2) Press the **(+)** key or the **(\*)** key.
- 3) Repeat steps 1 and 2 above to enter the number of copies for each original.

**Note:**

- **(+)** and **(\*)** keys can also move the entry box from top to bottom.
- To cancel or change a number, press the **(C)** key and enter again.
- To clear all (number of copies and number of sets), touch **[Clear All]**.
- The total number of all copies to be printed is shown on the top of the screen.

**Important!:**

- To save the current Programed Printing settings, touch **[Entry/Call]**.  
Once **[OK]** is touched, the setting cannot be saved.  
See “Saving Programs” (p.134) for further information.

**4 Touch [OK].**

Returns to the original screen. Ready to print in accordance with the program.

**Note:**

- Alternatively, after entering the number of copies or sets, press the **(START)** key to start printing without touching **[OK]**.

# Saving Programs

Store frequently-used Program settings for later use and printing. A total of 12 settings (Single or Multiple Mode) can be stored.

## 1 Create and enter Programed Printing settings.

Follow steps 1-3 in "Setting Up for Programed Printing" (p.132).

## 2 Touch [Entry/Call] on the Program Screen.

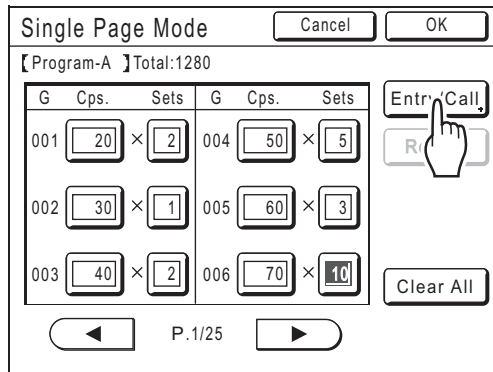

## 3 Touch an unused button.

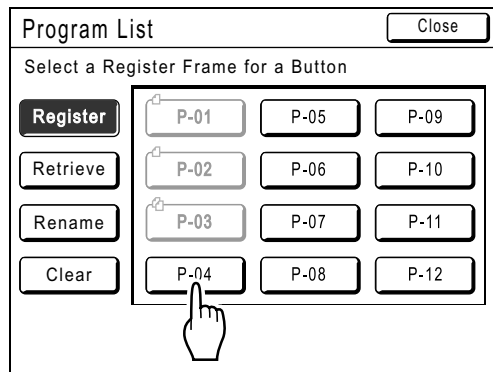

Unused buttons are displayed with a solid line. Used buttons are grayed out and are not available.

## 4 Touch [OK].

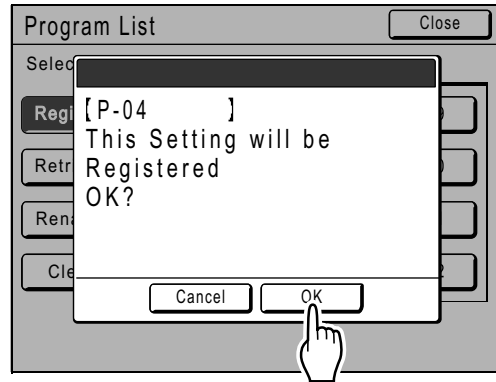

Returns to the Program List Screen. The Program is stored.

You can name each program for your convenience. See step 3 in "Renaming a Program" (p.135).

### Note:

- After saving the Program, touch **[Close]** on the Program List Screen to return to the Program Screen. Touch **[OK]** on the Program Screen to print from a saved Program.

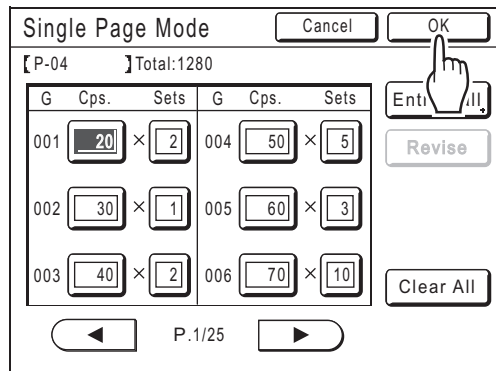



# Renaming a Program

Program names can be changed to better describe their usage or purpose.

## 1 Touch [Program] on the Functions Screen.

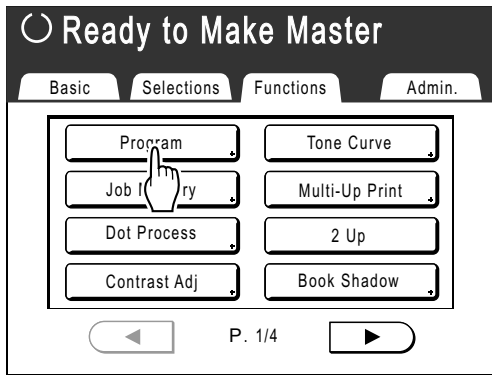

### Note:

- If [Program] is already highlighted, touching it will again display the Program Screen, and not the Rename a Program Screen. Touch [Cancel Job] then [OK] to return to the Functions Screen. Touch [Program] again.

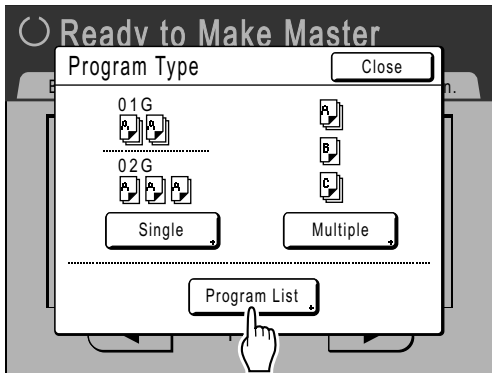

## 2 Touch [Program List].

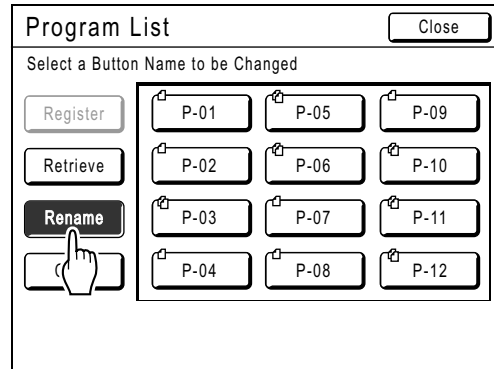

## 3 Touch [Rename].



### Note:

- Each Program button has an icon on top left.  indicates Single Page Mode Program,  indicates Multi-Page Mode Program.

## 4 Select a program to rename.

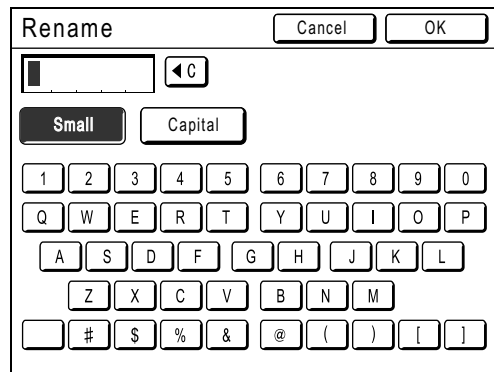

## 5 Touch character buttons to enter a new name.



Change capitalization by selecting [Small] or [Capital] button.

 p.136

### Note:

- To delete the current name, touch  button or press the  key.

## 6 When entered, touch [OK].

Returns to the Program List Screen. The program is renamed.

### Tip: Rename Screen

#### ◆ Small

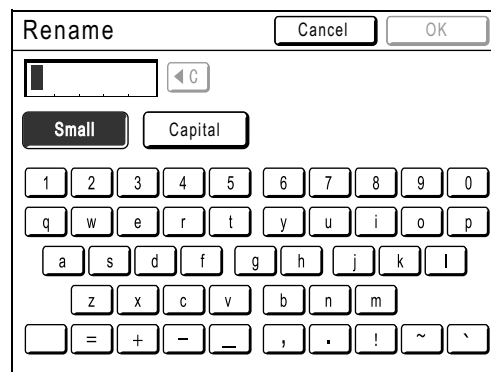

#### ◆ Capital

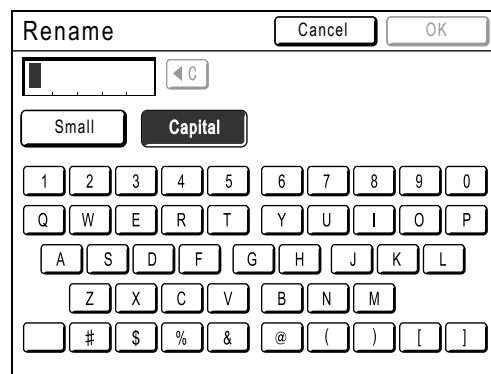

### Note:

- You can enter up to 10 characters.
- Print Quantity Keys may also be used for entering numbers.
- **<C** button or the **C** key clears previously saved or current entry. Touch to clear one character at a time.

## Retrieving a Program

Retrieve a stored program and modify its settings.

### 1 Press the **OP** key.

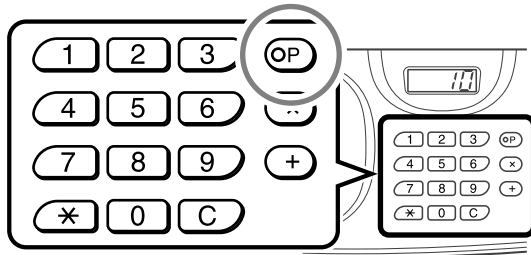

### 2 Touch **[Program List]**.

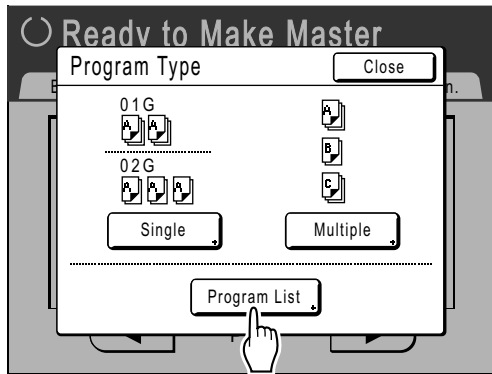

### 3 Touch a button to select a Program to retrieve.

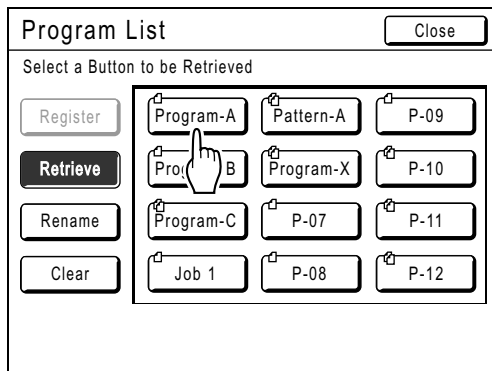

### 4 Touch **[OK]**.

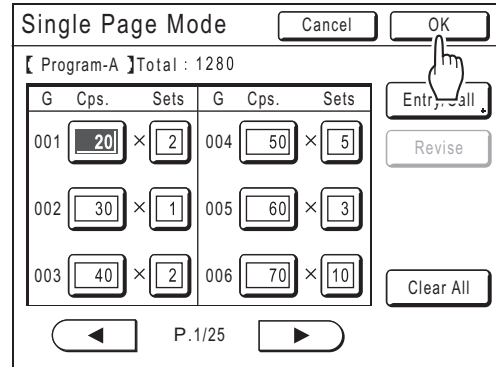

Returns to the original screen. Ready to print using the retrieved program.

#### Note:

- To cancel the program printing, press **OP** (or touch **[Functions]** → **[Program]**) and then touch **[Cancel Job]** on the next screen. Cancelling program printing by pressing the **RESET** button will reset other settings.

# Clearing Programs

## 1 Display the Program List Screen.

Follow steps 1-2 in “Retrieving a Program” (p.137).

## 2 Touch [Clear].

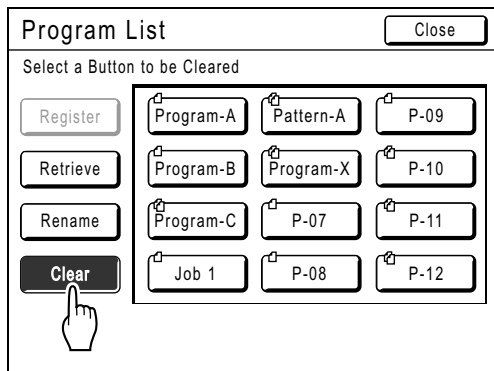

## 3 Select a program to delete.

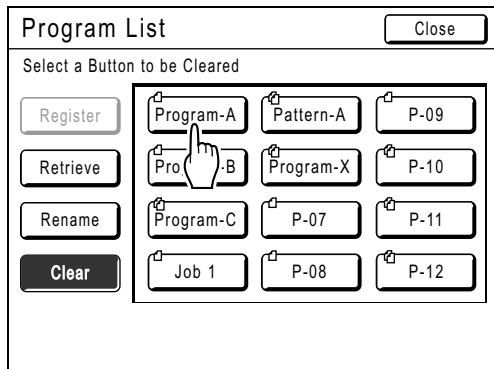

## 4 Touch [OK].

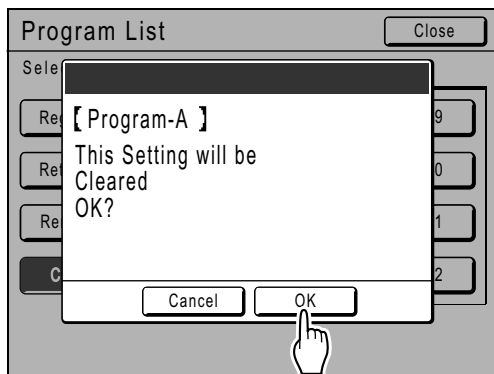

Returns to the Program List Screen. The program is deleted.

## Making changes to Stored Programs

### 1 Retrieve a program to modify.

Follow steps 1 and 3 in “Retrieving a Program” (p.137).

### 2 Make changes to the Program.

Modify the number of copies or sets in the current screen.

#### Note:

- See “Setting Up for Programed Printing” (p.132) for details on how to set up a program.

### 3 Touch [Revise].

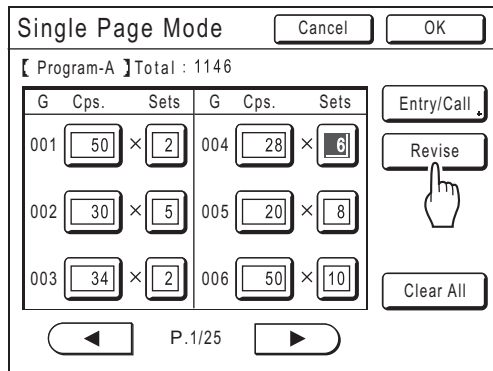

### 4 Touch [OK].

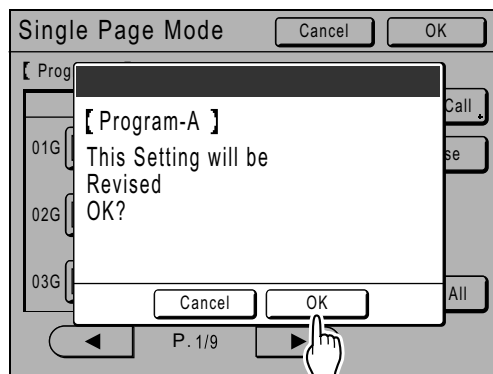

Returns to the Program Screen. “Program” settings are updated (overwritten).

## Using Job Memory Functions [Job Memory]

Save the settings of the last print job into “Job Memory”. Simply retrieve those “Job Memory” settings when doing a similar print job. Up to 10 jobs can be saved.

The following attributes can be saved to “Job Memory”.

### ◆ MasterMaking/Print

Image	Multi-Up Print	Print Position	Auto Page Renewal
Dot Process	Layout	Paper Feed Adj.	Scanning Side-ADF*
Contrast	Top Margin	D-Feed Check	Air Blow
Ink Saving	Contrast Adj	Jump Wing Control	Separation Fan
Size	Tone Curve	Auto Process	Pre-suction Fan
Margin+	Binding margin	Interval	Suction Fan
Paper Size	Print Quantity	ADF Semi-Auto*	
Max. Scan	Print Speed	Sorter*	
Book Shadow	Print Density	Job Separation*	

\*: Available with optional device

## Storing Job Memory

- 1 Set various settings for a print job.
- 2 Touch [Job Memory] on the Functions Screen.



**Note:**

- Job Memory Screen can also be invoked by pressing the key on the Print Quantity Keys.

- 3 Touch an unused button.

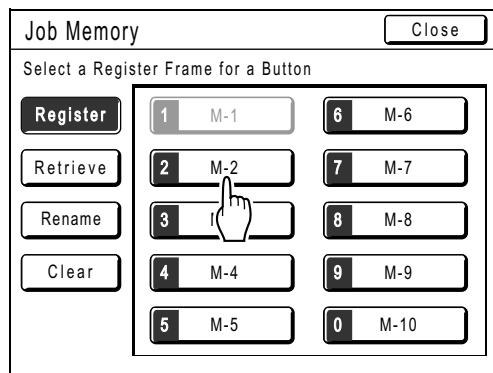

Unused buttons are displayed with a solid line. Used buttons are grayed out and are not available.

**Note:**

- If you pressed the key to open the screen, first touch [Register] then select an available button.

- 4 Confirm settings.

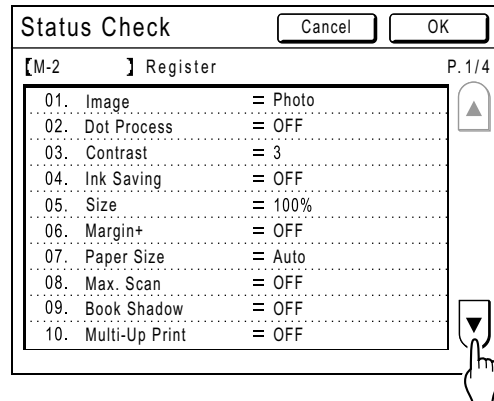

Touch and scroll down to check all items.

**Note:**

- To change a setting, touch [Cancel] and start over again. (Return to step 1.)

- 5 Touch [OK].

Returns to the Job Memory Screen. Settings are updated.

Each job memory can be named for your convenience. See step 2 in “Renaming a Job Memory” (p.142).

# Renaming a Job Memory

**1 Touch [Job Memory] on the Functions Screen.**

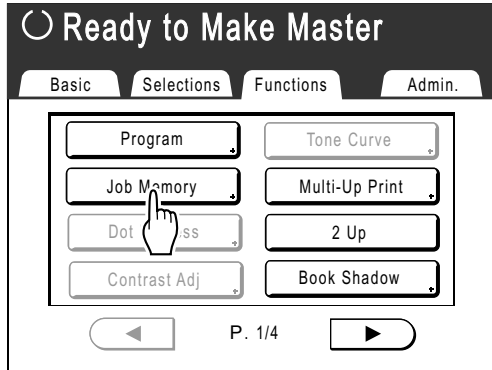

**2 Touch [Rename].**

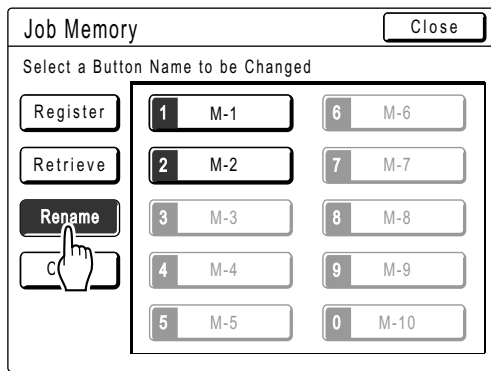

**3 Select a Job Memory to rename.**

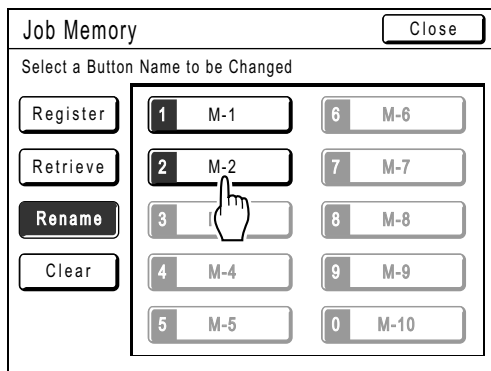

Unregistered buttons are grayed out and are not available.

**4 Touch character buttons to enter a new name.**

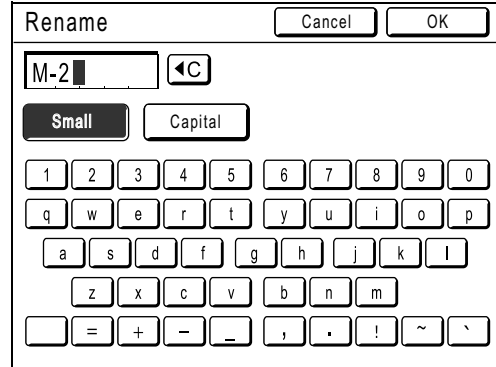

Change capitalization by selecting **[Small]** or **[Capital]** button.  
 ☞ p.136

**Note:**

- To clear the current name, touch **[C]** button or press the **[C]** key.

**5 When entered, touch [OK].**

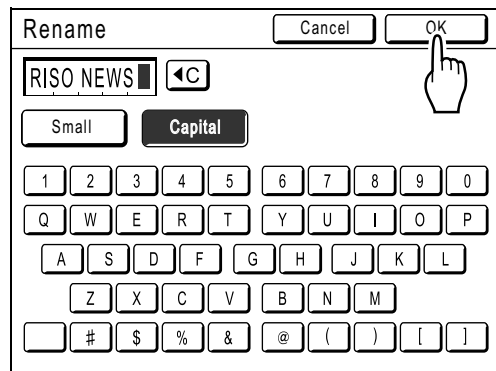

Returns to the Job Memory Screen. The name is updated.



## 6 Touch [Close].

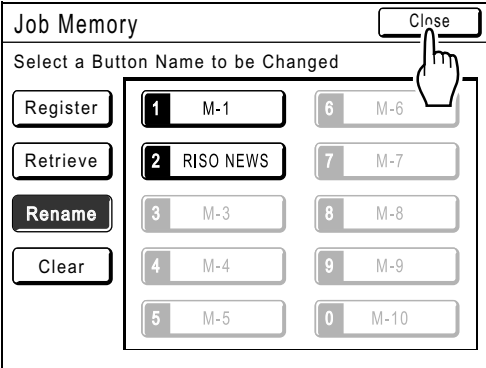

The screenshot shows the 'Job Memory' screen. At the top left is the title 'Job Memory'. At the top right is a 'Close' button. Below the title is the instruction 'Select a Button Name to be Changed'. On the left side, there are four buttons: 'Register', 'Retrieve', 'Rename', and 'Clear'. The 'Rename' button is highlighted. In the center, there is a grid of ten buttons labeled '1 M-1' through '0 M-10'. The '2 RISO NEWS' button is highlighted. A hand icon is pointing to the 'Close' button.

Returns to the Functions Screen.

# Retrieving a Job Memory and Printing

There are two ways to display the Job Memory Screen.

- Touch **[Job Memory]** on the Functions Screen on the display.
- Press the  key of the Print Quantity Keys.

In the following steps, the explanation will be made for touching the display.

## 1 Touch [Job Memory] on the Functions Screen.



## 2 Touch [Retrieve].

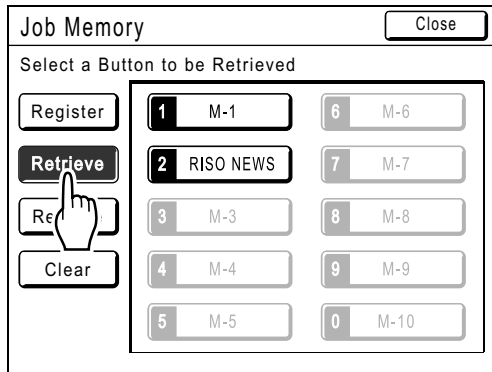

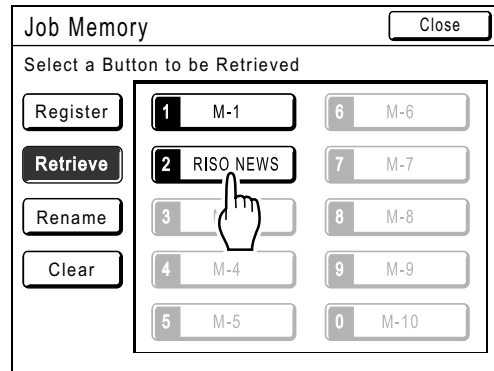

Unused buttons are displayed with a solid line. Used buttons are grayed out and are not available.

## 3 Select a Job Memory to retrieve.



**Note:**

- A job setting can also be retrieved using the Print Quantity Keys.  
M-1 to 9:  to   
M-10: 

## 4 Confirm the settings and touch [OK].

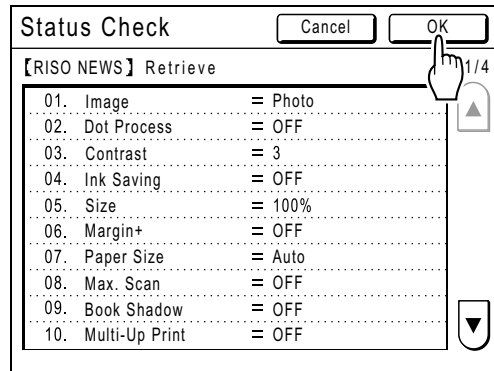



Returns to the Functions Screen. Ready to print using the retrieved job settings. Continue with the normal printing processes.

**Note:**

- To cancel a retrieved job memory, press the  key.

**Tip:****Quick Retrieval**

A job setting can be retrieved via hardware keys without touching the Touch Screen.

For example, to retrieve and print job M-2, press the , ,  key in that order. M-2 is retrieved and starts the master-making process.

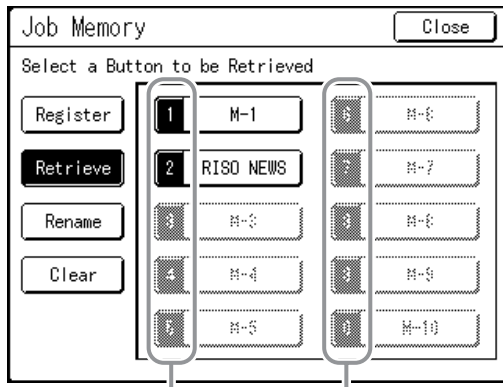

Registered Number

# Clearing Job Memory

**1 Touch [Job Memory] on the Functions Screen.**

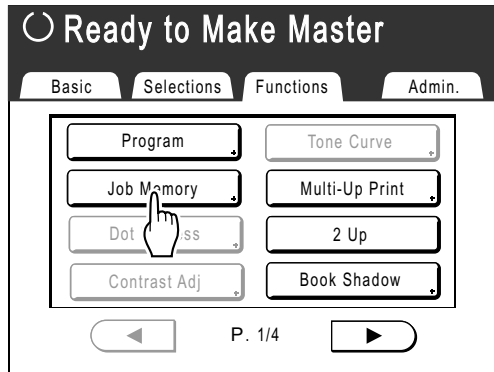

**2 Touch [Clear].**

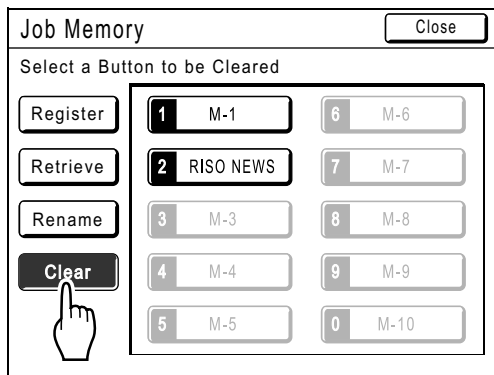

**3 Select a Job Memory to clear.**

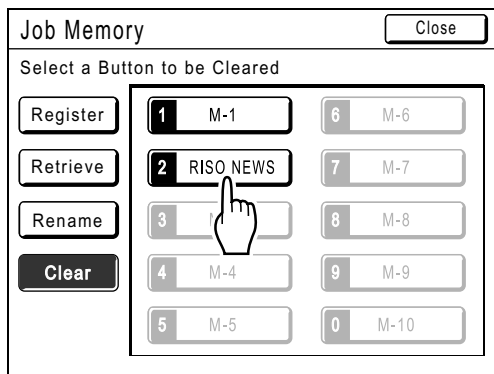

**Important!:**

- Make sure it is the job setting that you want to delete.
- Once deleted, it cannot be restored.

**4 Touch [OK].**

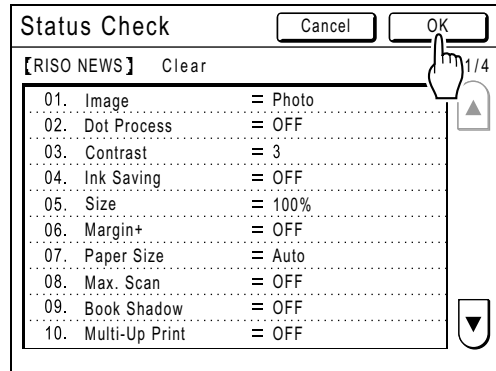

**5 Touch [Close].**

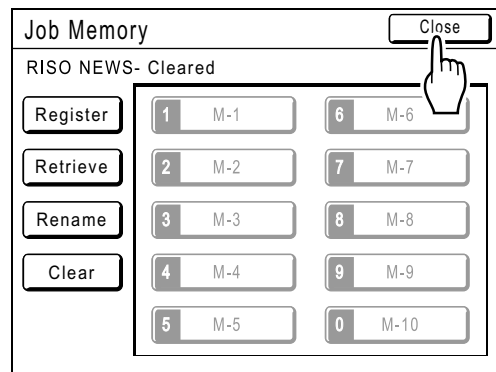

Returns to the Functions Screen.

# Protecting Confidential Documents

## [Confidential]

After printing is complete, the master remains on the Print Drum (Cylinder) and is ready for printing another set of copies. To protect confidential documents from unauthorized duplication, use the Confidential feature to discard the master after printing.

### Note:

- When “Confidential” is performed, the discarded master may no longer be reproduced, and “Renew Page” feature is disabled.
- If “Idling Action” is set to “ON”, “Idling Action” is executed using a confidential master (use this function when not using the Print Drum (Cylinder) for extended period of time).
- You can set the machine to remind users to use the “Confidential” feature every time it is used.

☞ p.182

### 1 Make sure printing is completed.

Confirm that everything is printed.

### 2 Touch [Confidential] on the Functions Screen.



### 3 Touch [OK].

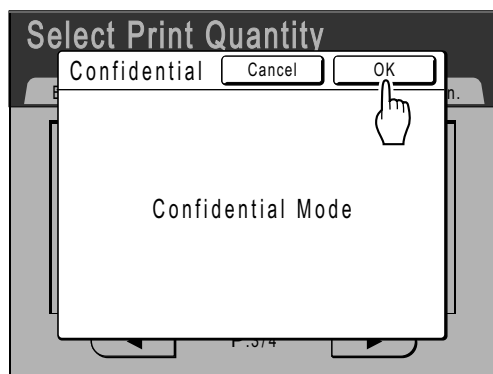

The current master is discarded, and a new master is set on the Print Drum (Cylinder).

## Extending the Reserve Period [Reservation]

This function is useful when the machine is connected to a computer. When the machine is inactive for a certain period of time, it determines that the current job is completed, even if the actual printing is still under way. If another person accidentally initiates another job from the computer, a new master will be made, discarding the current one.

By extending “Reserve Period”, such interruption can be prevented. We recommend that you activate the “Reservation” setting when temporarily pausing a job or when printing leaflets etc. to prevent interruption.

### Note:

- Select from 5, 10, or 30 minutes as the “Reserve Period” on the Admin. Screen. The factory default is 5 minutes.   
☞ p.169
  - The following operations do not count towards reservation period:
    - When the machine is operating (making a master, printing, confidential action, idling, etc.)
    - When the Job Separator (option) is operating
    - When Control Panel buttons are being entered
    - When the Setup Screen for some function is displayed
  - Auto Sleep and Auto Power-OFF will be disabled during the reservation period.
    - Auto Sleep/Auto Power-OFF: timer re-activates after the reservation period is up.
    - Power-OFF Schedule: will not shut off until that time on the next day.
- ☞ p.170

### Touch [Reservation] on the Functions Screen.

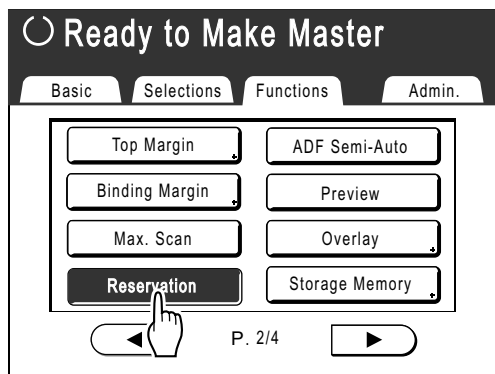

Reservation period is extended.

# Idling Action [Idling Action]

Idling action prevents the machine from printing the first several copies with faint Ink after the Print Drum (Cylinder) has been exchanged or the machine has not been used for an extended period of time. Idling action before the master-making process assures consistent print quality from the beginning.

## Important!:

- “Idling Action” is effective only in conjunction with the master-making process. When performing print processes only, “Idling Action” will have no effect.

## Note:

- To perform “Idling Action” automatically when making a master after a specified period of time since the last print job, set “Auto Idling” on the Admin. Screen.

☞ p.171

## 1 Touch [Idling Action] on the Functions Screen.

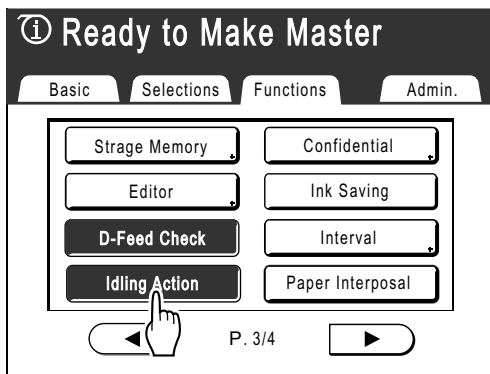

**i** appears on screen.

## 2 Press the key.

After “Idling Action” has been finished, the master-making process starts.

## Note:

- If **i** displays in the screen message area even though it is not set, this indicates that the “Auto Idling” time has elapsed. If you make a master in this status, “Idling Action” is executed.



- Remember to load the originals before pressing  as the master will be made immediately after “Idling Action” finishes.

# Reproducing the Master

## [Renew Page][Auto Page Renewal]

The data from the last master-making process is temporarily stored on the machine.

Using this data, another master can be reproduced without repeating steps to scan the same original.

You can “Rotate” the original and recreate a master.

“Auto Page Renewal” is a function that automatically recreates a master when a specified number of pages are printed. If you are printing a large-volume job of thousands or tens of thousands of copies, the master may degrade before the job is completed.

If you set “Auto Page Renewal” to “ON” prior to starting a large-volume print job, a master will be automatically recreated when the specified number of copies is reached (Auto Renewal Point). This allows you to maintain a consistent print quality from start to finish.

### Note:

- “Renew Page” works with data sent from a computer as well. However, if multiple pages exist, only the last page will be processed with “Renew Page”.
- The “Renew Page” function is not available in the following conditions:
  - immediately after startup
  - after pressing the  key
  - after executing “Auto Clear” (“Changing Default settings” p.170)
  - after performing “Confidential”
  - when an error has occurred during master-making
  - after master-making for Data Output Mode (when the optional Key Card Counter is installed.)
- When “Renew Page” or “Auto Page Renewal” is selected, 2 proof copies will be made. When the print position has been adjusted, the printer will center the Print Drum (Cylinder) to their original position, recreate the master and print a proof copy. Then, the Print Drum (Cylinder) will move to the previously adjusted position and print another proof copy.
- The number of pages in the proof copy when using “Auto Page Renewal” can be adjusted using “Admin.”. p.171
- When the print position has been adjusted, 2 proof copies will be made. (When the print position has not been adjusted and when the print position has been adjusted)



## Using Page Renewal

### 1 Touch [Renew Page] on the Functions Screen.

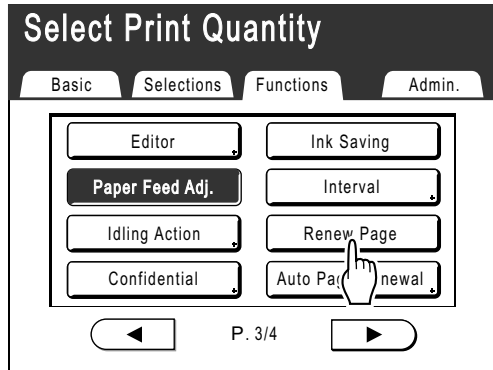

#### Note:

- If you touch and select **[Rotate]**, you can rotate the original 180 degrees for renewing the master.
- When “Rotate” is set, the machine rotates the original 180 degrees for renewing the master while executing “Auto Page Renewal”.
- To cancel “Rotate”, touch **[Rotate]** again.

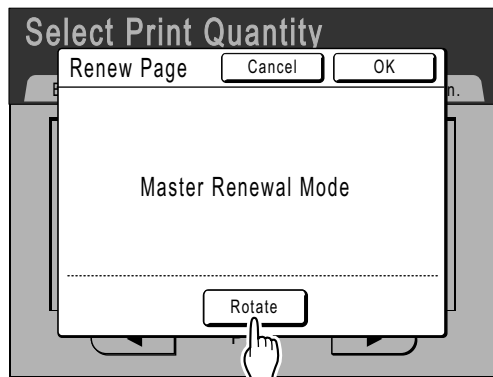

### 2 Touch [OK].



“Renew Page” begins reproducing the master.

## Using Auto Page Renewal

In order to use “Auto Page Renewal”, you must enable it in “Admin.” prior to use.

If “Auto Page Renewal” is activated and “Auto Page Renewal” is set to “ON”, “Auto Page Renewal” can be executed during a print job.

### Important!:

- If “Auto Page Renewal” is not activated in “Admin.”, “Auto Page Renewal” cannot be set to “ON”.  
☞ p.171
- The “Auto Page Renewal” is set to “OFF” in the following instances.
  - When printing with “Program”
  - When the  or the  is pressed
  - When attempting to process the next job with direct print

### Note:

- The factory settings are such that a master is recreated every 1000 copies, with a setting to print 3 proofs. This setting can be changed in “Admin.”. ☞ p.171

## Turning ON “Auto Page Renewal”

### Touch [Auto Page Renewal] on the Functions Screen.

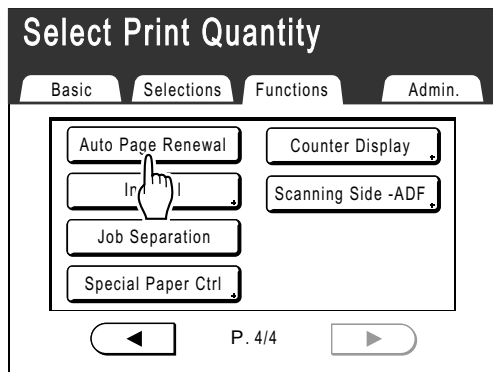

“Auto Page Renewal” is activated.

When you print with these settings, “Auto Page Renewal” will be executed after the specified number of copies are printed.

### Note:

- If [Auto Page Renewal] is grayed out, go to “Admin.” and turn “Auto Page Renewal” ON.  
☞ p.171

# Print the original from the last page

## [Output reversal]

By reversing the page order of the originals of several pages in length, print the originals from the last page.

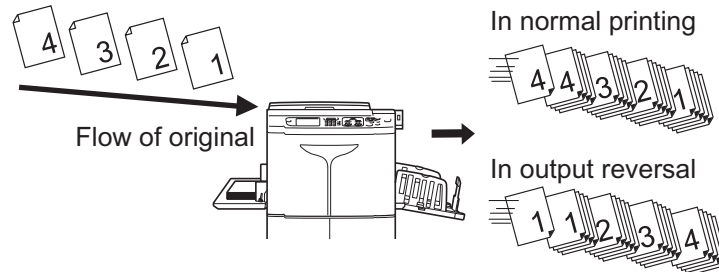

### Important!:

- To use this function, the optional Document Storage Card is required.
- While scanning the original, if there is no free memory space, the scanning stops to display a message. After canceling original scanning or arranging (clearing) the storage data, scan the original once again.
- You cannot use “Output Reversal” unless you set “CI Select” to “Internal CI” on the Admin. Screen. See “Changing Default Settings/CI Select” (p.168).

### Note:

“Output reversal” is not available in combination with the following functions:

- Program ([Multiple])
- Preview
- Overlay
- Storage Memory

### 1 Set the original and print paper.

Place the original on the Glass Platen or in the optional ADF unit.

To place the original, see p.41.

### 2 Touch [Output reversal] on the Functions Screen.

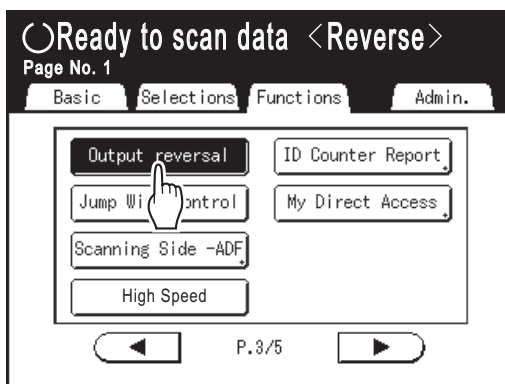

The button is inverted, and “Output Reversal” is set to “ON”.

### 3 Configure print functions.

Set various functions as needed.

### 4 Press the key.

Scan the 1st original.

When the optional ADF unit is used, proceed to step 6 after all the originals are scanned automatically.

### 5 When the original has several pages, replace the originals and repeat steps 3 and 4.

## 6 Touch .

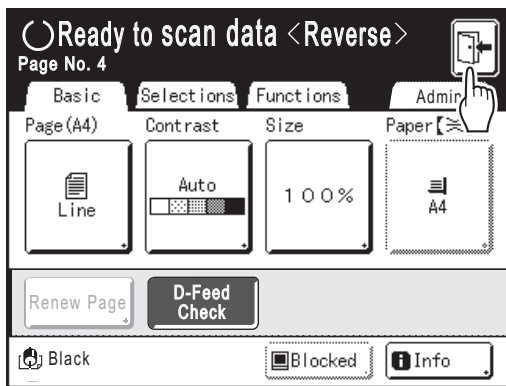

The confirmation screen for master-making is displayed.

## 7 Touch [Yes].

The Master Making Basic Screen for storage data is displayed. Various output instructions can be changed.

☞ p.26

### Note:

- To cancel output reversal without making a master, touch **[No]**. To return to the previous step, touch **[<Back]**.

## 8 Press the key.

The master-making starts from the last page scanned, and Print Basic Screen for storage data is displayed.

## 9 Enter the print quantity using the **Print Quantity Keys**.

The entered quantity is displayed on the Print Quantity Display.

## 10 Press the key.

Printing starts.

Afterwards, repeat steps 8 to 10.

# Proof and Print

## (only when the ADF unit is installed)

### [ADF Semi-Auto]

Selecting “Auto Process” with the optional ADF unit installed automatically performs the complete printing job, but you cannot make proof copies, or any necessary adjustments of each master. To pause for check after printing a proof copy of each master, select “ADF Semi-Auto”.

#### Important!:

- Turn “Auto Process” OFF when using “ADF Semi-Auto”.  
☞ p.66

#### Note:

- The default “ADF Semi-Auto” can be set on the Admin. Screen.  
☞ p.168

### 1 Touch [ADF Semi-Auto] on the Functions Screen.

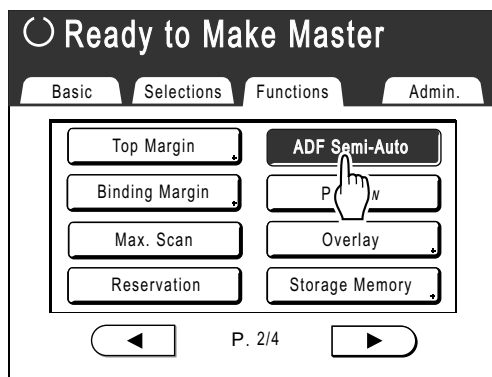

“ADF Semi-Auto” is selected.

#### Note:

- When “ADF Semi-Auto” is not displayed (or displayed in gray), turn off the “Auto Process” key on the Control Panel.

### 2 Place original(s) in the ADF unit.

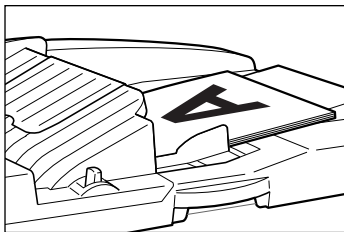

The ADF unit detects the document, and automatically opens the Master Making Basic Screen. To place the original, ☞ p.41.

### 3 Enter the number of copies using the Print Quantity Keys.

The number is displayed on the Print Quantity Display.

#### Note:

- To change the number, press the **C** key, then re-enter the correct number.

### 4 Press the **START** key.

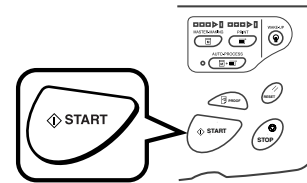

After a master is made, a proof copy is printed and the job stops.

### 5 Check the proof copy.

Make adjustments if needed.

### 6 Press the **START** key.

The machine prints specified number of copies. Master for the next original is made, its proof copy is printed, then the machine stops again.

**Repeat steps 5 and 6.**

# Selecting Scanning Sides When Using the Auto Document Feeder DX-1

## [Scanning Side -ADF]

When scanning originals using the optional Auto Document Feeder DX-1, there are three scanning side options: “Front Side”, “Back Side”, or “Duplex”.

**Important!:**

- If the original is set on Auto Document Feeder DX-1, “Book Shadow” function cannot be used.

**Note:**

- The upside when the original is set is “Front Side”. The set original is scanned sequentially from the top.
- Go to “Admin.” and select “Scanning Side -ADF” to save a frequently used setting as the default.  
☞ p.167

◆ **Front Side -> Simplex**

Scans the front side of the original, and prints on one side.

**Important!:**

- If the “Top Margin” function is used, the setting, “Front Side -> Simplex” must be used.

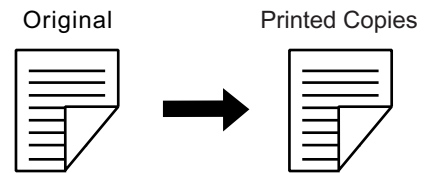

◆ **Back Side -> Simplex**

Scans the back side of the original, and prints on one side.

**Important!:**

- When “Sorter” is set to ON, “Back Side -> Simplex” is automatically selected. Place the original face-down.

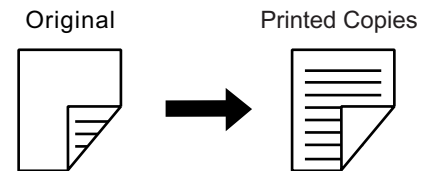

◆ **Duplex -> Simplex**

Scans both sides of the original and prints on one side. The front side is scanned first and then the back side. “Setting Direction” and “Paging Direction” of the original must be specified.

**Important!:**

- The “Duplex -> Simplex” option is not available in “Program; Multi-Page Mode” Likewise, if “Duplex -> Simplex” is selected, “Multi-Page Mode” is not available.

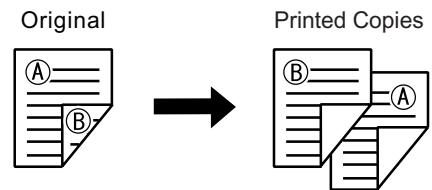

**Note:**

- If the original includes blank pages, these will also be scanned and included in copies.

## ◆ The processing order of the original and output

The original set in Auto Document Feeder DX-1 is scanned and printed from the top.

### Note:

- In “Program; Multi-Page Mode”, the first page of the original scanned is displayed as “Page01” on the Setup Screen.

e.g.

With the “Back Side -> Simplex” option, the last page of the original is displayed as “Page01” on the Setup Screen because scanning starts from the last (topmost) page.

### Front Side -> Simplex

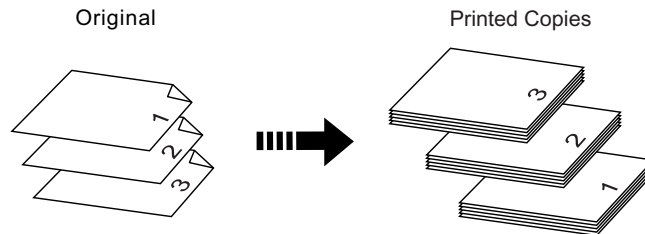

### Back Side -> Simplex

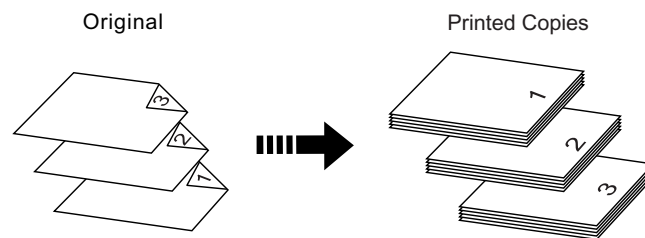

### Duplex -> Simplex

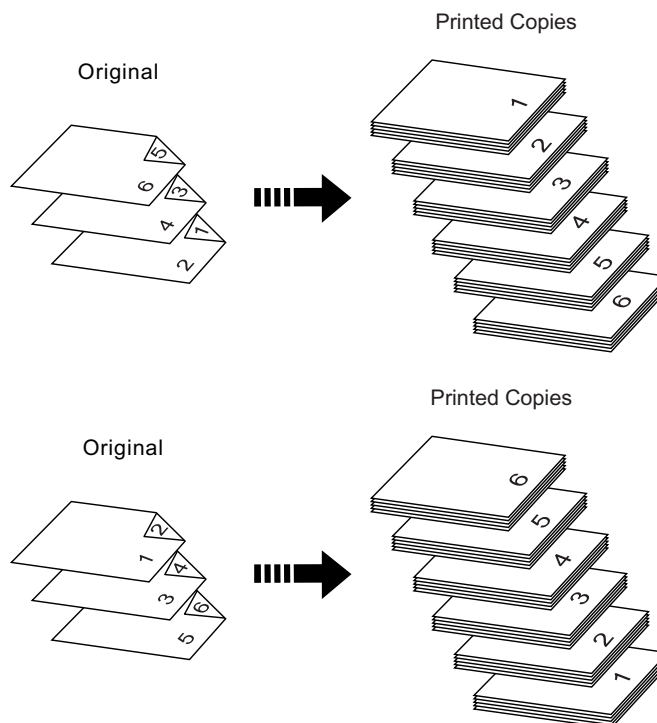

# Specifying the Scanning Side

**1 Touch [Scanning Side -ADF] on the Functions Screen.**

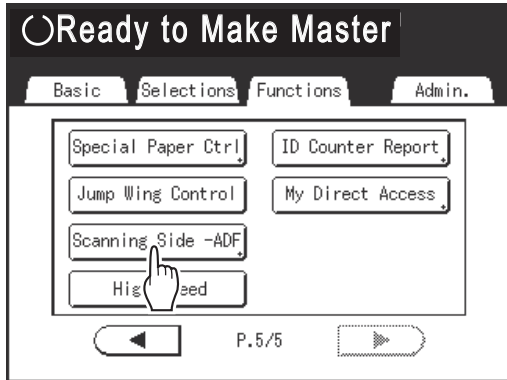

**2 Touch a scanning option button.**

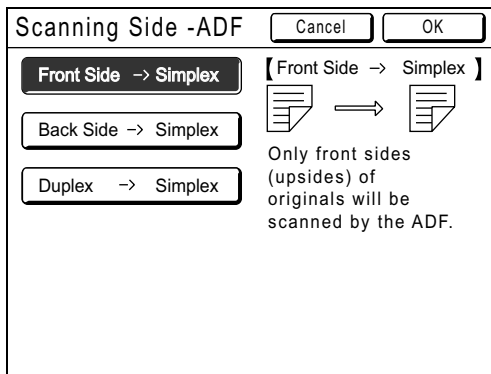

**◆ When you select [Duplex -> Simplex]**

Touch to select [Setting Direction] and [Paging Direction] buttons, shown on the screen.

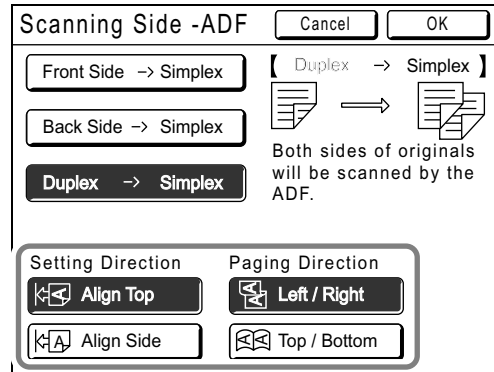

See p.156 for details of scanning options.

**3 Touch [OK].**

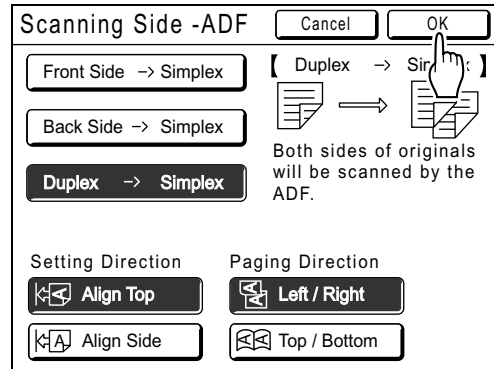

Returns to the Basic Screen after the “Scanning Side -ADF” settings have been saved.

**Note:**

- To confirm the current “Scanning Side -ADF” settings, open the “Scanning Side -ADF” Screen once more. The selected settings buttons are highlighted.



**Tip:**  
**Scanning duplex originals for manual duplex printing**

With the optional Auto Document Feeder DX-1, the buttons on the “Scanning Side -ADF” Screen can be used to scan both sides of an original and print on both sides of paper.  
 e.g.) Scanning the duplex original for duplex printing.

- 1) Set the original for duplex printing.

← Original orientation

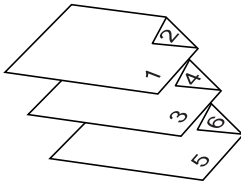

- 2) Select [Front Side -> Simplex] for printing.

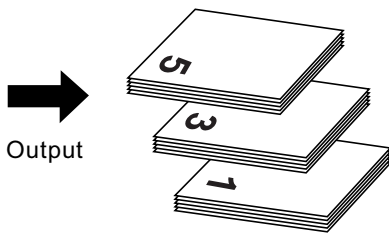

- 3) Place the printing paper face down in the Paper Feed Tray.

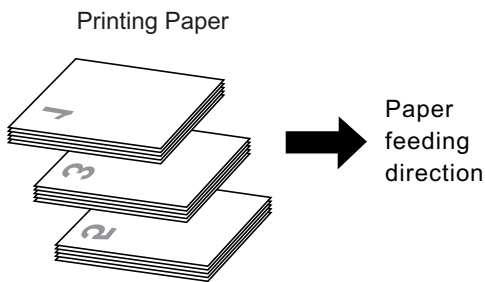

- 4) Set in the same orientation as shown in step 1.

← Original orientation

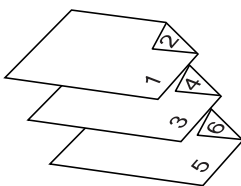

- 5) Select [Back Side -> Simplex] for printing.

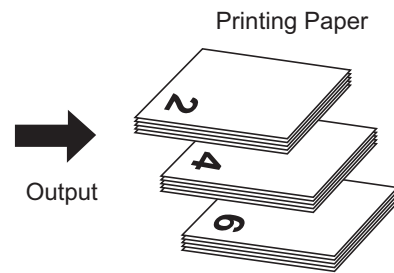

# Checking User Counters [ID Counter Report]

Each user can output counter data (number of prints, etc.) when checking usage status.

## Important!:

- “ID Counter Report” can be outputted only when the “User Management” function is set.

## ◆ Report Output

Counter data can be output by following methods:

- Print  
Prints the counter data.
- E-mail  
E-mail attached with the counter data is sent to the e-mail addresses set as the destination.  
The mail settings must be set in advance. For details on mail settings, the RISO Network Card is required. For details, see the “RISO Network Card User’s Guide”.
- USB Flash Drive  
Outputs the counter data to the USB Flash Drive.  
USB Flash Drive must be connected to the USB slot in advance.

## Note:

- By using the “RISO Utility Software” (RISO COPY COUNT VIEWER) included on the provided CD-ROM, the counter data output to the USB Flash Drive can be managed by a computer.  
For details, see the “RISO Utility Software User’s Guide”.

## Setting the reminder date

For regular counting, a reminder date can be set.  
The following screen is displayed on the set date.

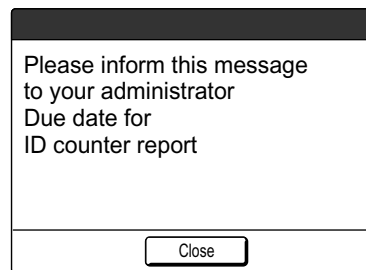

## Important!:

- To manage usage status correctly, the following setting is required. If you do not make the following setting, you cannot count the number of prints/masters correctly.
  - Set **[Management Level]** to **[High/Full Management]** in User Management. [p.114](#)
  - If you print from the computer, be sure to use “ID Print”. See the “RISO Printer Driver User’s Guide” for details.

## Outputting the Counter Report

- 1 Touch [ID Counter Report] on the Functions Screen.

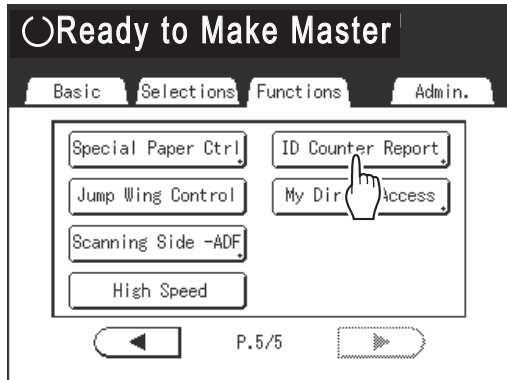

- 2 Touch the button of the desired output method.

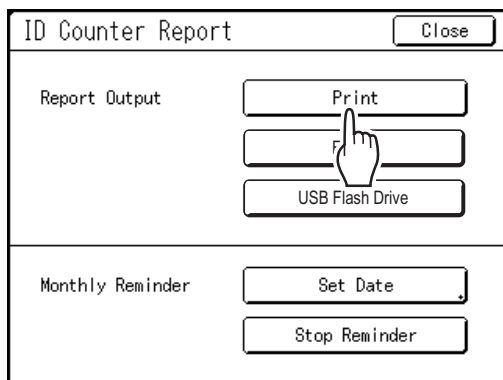

Returns to the Basic Screen after output.

If the mail setting is not set, **[E-mail]** is not available.

Consult your dealer (or authorized service representative) about mail settings.

If the USB Flash Drive is not connected, **[USB Flash Drive]** is grayed out and not available.

## Setting Up the Monthly Reminder

### 1 Touch [ID Counter Report] on the Functions Screen.

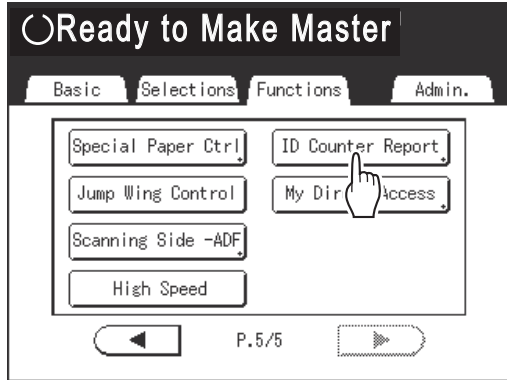

### 2 Touch [Set Date].

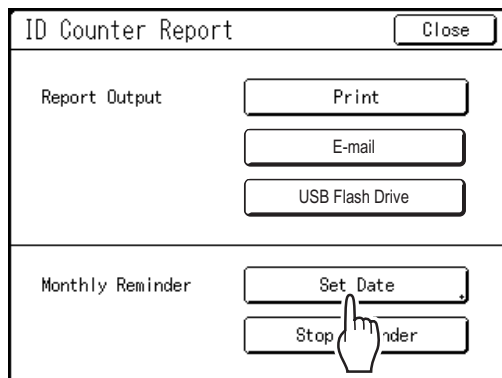

### 3 Touch ▲ or ▼ to set the reminder date.

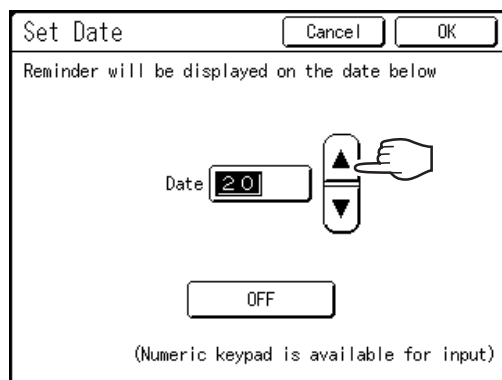

If the [Date] button is grayed out, touch [OFF] and input the date.

#### Note:

- Print Quantity Keys can also be used to enter numbers.
- The set date can be selected between 1 and 31.
- When setting the reminder date between the 29th - 31st, and if the number of days in the month is less than this range such as in February, the Reminder Screen is displayed on the last day of the month.
- If you are not setting the reminder date, touch [OFF].

### 4 Touch [OK].

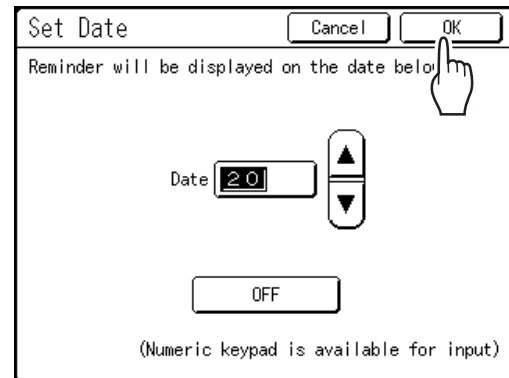

Returns to the ID Counter Report Screen.  
The reminder date is updated.

### 5 Touch [Close].

Returns to the Functions Screen.

#### Note:

- Once the reminder date is set, a "Reminder Screen" is displayed on each reminder date. In fact, this message is displayed each time the machine is turned ON until the counter report is output. If you do not want to output the counter data on the set date of this month, touch [Stop Reminder]. The Reminder Screen is not displayed until the reminder date of the next month.

# Showing Usage Status

## [Meter Display]

The machine can record and display the following information:

**A4/Letter and Under:** Total number of A4/Letter-sized and smaller copies that have been printed.

**Above A4/Letter:** Total number of copies larger than A4/Letter that have been printed.

**Total:** The total number of copies printed by the machine.

**A3/Ledger Master Count:** Total number of A3/Ledger-sized masters that have been made.

**A4W/LetterW Master Count:** Total number of A4W/LetterW-sized masters that have been made.

**Master Count:** The total number of masters made by the machine.

**Print Drum:** The total number of copies that have been printed with the currently installed Print Drum (Cylinder).

**Job Count:** Start and stop as needed.

For example, to keep a track of the number of prints made in a day, set “Job Count” to 0 in the morning, and check the counter at the end of the work day to get the count.

### Note:

- When using more than one Print Drum (Cylinder), install the Print Drum (Cylinder) for which you need information before displaying the Counter Display screen.

## 1 Touch [Meter Display] on the Functions Screen.



## 2 Review counts.

Meter Display		Close
A4/Letter and Under	0	
Above A4/Letter	0	
Total	0	
A3/Ledger Master Count	0	
A4W/LetterW Master Count	0	
Master Count Total	0	
Print Drum Meter	0	
Job Count		0 ◀C

### Note:

- Using the “Job Count”

1) Touch ◀C to set the counter to 0.

2) Touch [Close] to close the Meter Display Screen. Operate the machine as normal.

3) To display and review the Job Count, follow step 1.

## 3 Touch [Close] to close the window.

Returns to the Functions Screen.

# Customizing the Direct Access Area

## [My Direct Access]

Normally, the functions displayed in the Direct Access Area of the Basic Screen are already registered by the default setting or can be changed by the administrator. However, if the User Management is set up, each user can register the functions displayed in the Direct Access Area using "My Direct Access".

The functions that can be displayed in the Direct Access Area can individually be registered in each mode (Master Making/Print/Scanning).

Up to 4 functions can be registered.

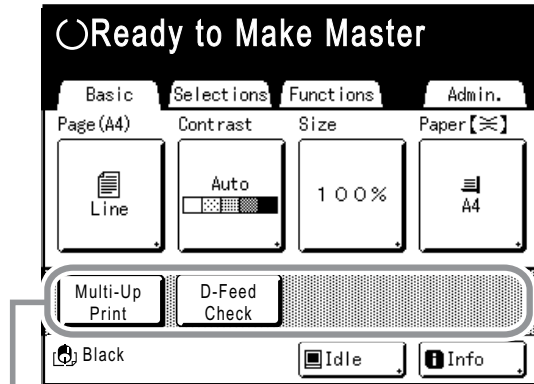

Direct Access Area

"My Direct Access" registered by each user can be displayed after the user has been identified and cannot be changed by other users.

**Note:**

- "My Direct Access" can be set when "Management Level" is set to "High/Full Management" in "User Management".
- If "My Direct Access" is not set, the functions registered via the usual methods are displayed in the Direct Access Area. (p.176)

### 1 Touch [My Direct Access] on the Functions Screen.

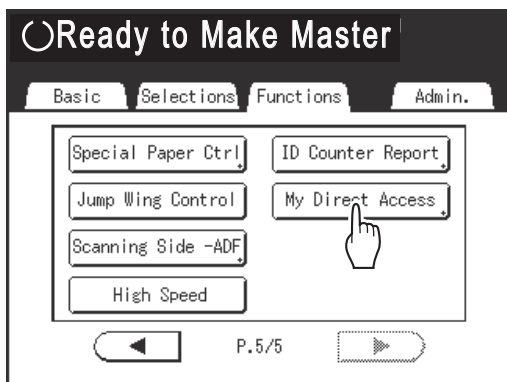

If "Management Level" is not set to "High/Full Management" in "User Management", the **[My Direct Access]** button is grayed out and is not available.

**Note:**

- Consult your administrator for Management Level.

### 2 Select a mode tab to register new buttons.

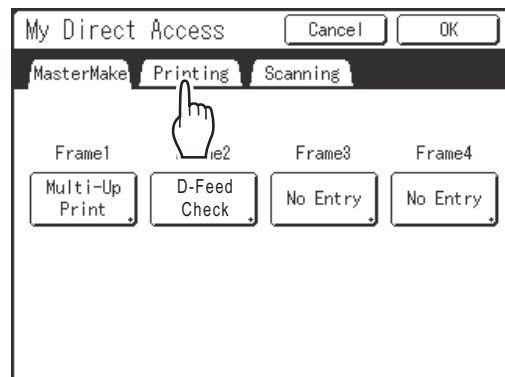

### 3 Select a button to assign a function to.

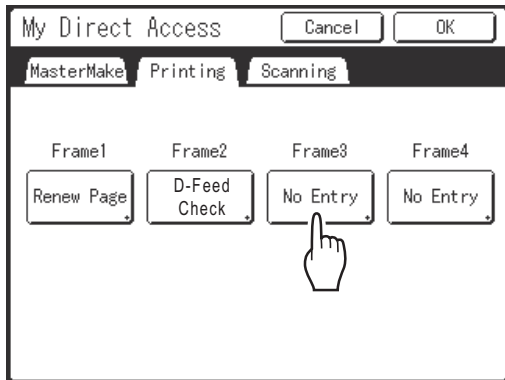

If the button has a function already assigned to it, the newly selected function will overwrite the previous one.

### 4 Select a function to assign.

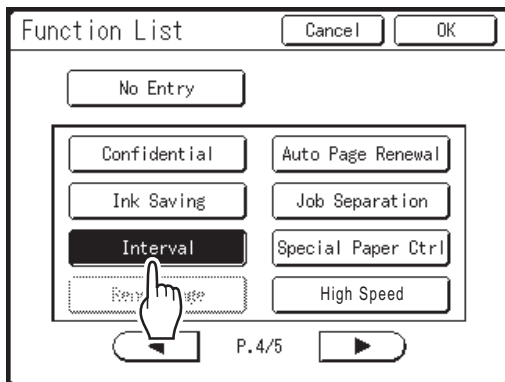

#### Note:

- Touch ◀ or ▶ to display more functions, if necessary.
- To remove a function that is accidentally assigned, touch **[No Entry]**.
- Functions already assigned are grayed out and are not available.
- Some functions are displayed only when optional devices are installed.

### 5 Touch [OK].

Returns to "My Direct Access" Screen. The selected functions are added.

To add more functions or to replace a button with another function, repeat steps 3 to 6.

### 6 Touch [OK].

Returns to the Functions Screen.

# Changing Default Settings [Admin.]

You can modify the Default Settings to best suit your needs.  
You can edit them as needed.

## Important!:

- If the administrator is registered in User Management, only the administrator can change the **[Admin.]** settings. (This operation requires input of the administrator's PIN Code or connection of the registered USB Flash Drive.)  
☞ p.120
- Depending on the usage environment, the "Admin." features may not be available (the "Admin." tab may not be displayed).  
For details, consult your dealer (or authorized service representative).



## Note:

- The default settings are the values restored when the machine is turned ON or when the  key is pressed.

## Configurable Functions

—:Initial settings (factory default)







\* This function can be set only when the option is installed.



Display Access Button	Functions	Description
<b>[Display]</b>	DirectAccess Entry Store frequently-used functions on the Basic Screen for each mode.	☞ p.176
	Selections Entry Store frequently-used functions on the Selections Screen for each mode.	☞ p.176
	Display Priority Select first screen to display following the Startup. <b>Note:</b> <ul style="list-style-type: none"> <li>• The Mode Screen is available only when "Mode Key Pattern" is set to "Mode Selection".</li> </ul>	Mode Screen/RISO Print/ Scanning
	Mode Key Pattern Select screens to display when the  key is pressed. <b>[Mode Selection]</b> Pressing the  key will open the Mode Screen no matter which screen you are currently on. <b>[Loop]</b> The screen changes as shown below when the  key is pressed. <ul style="list-style-type: none"> <li>• Normally: "Master Making Basic Screen" ↔ "Print Basic Screen"</li> <li>• When the optional Document Storage Card is installed: "Scan Basic Screen" ↔ "Master Making/ Print Basic Screen"</li> </ul>	<u>Mode Selection/Loop</u>



Display Access Button	Functions	Description
<b>[Display]</b>	Start-Up Screen Select an animation to display at Start-up.	Logo(RISO)/ <u>Logo(SE)</u> /Character
	Metric/Inch Switch (for SE9480 only) Change the format for displaying measurements to metric or inches (imperial).	<u>Inch</u> /mm
	Display Adjustment Change the background color, density and brightness of the Touch Screen. When "ECO mode" is set to "ON", the Backlight Lightness is locked at "-2".	Background:Blue/ <u>White</u> Display Density -5, -4 ... -1, <u>0</u> , +1 ... +4, +5 Backlight Lightness: -2, -1, <u>0</u> , +1, +2
	Job list display Change the file name display of the stored data in Storage Selection Screen, Job List Screen and USB Job List Screen.	<u>From top</u> , From bottom
	Displayed Language Select the language displayed on the screen.  <b>Important!:</b> • Contact your dealer (or authorized service representative) to change the settings.	#01, #02, #03 ...
<b>[Default]</b>	Image Processing Change the default setting for the "image processing mode".	<u>Line</u> /Photo/Duo (Text and Photo)/Pencil
	Scanning Contrast Change the default settings for the "scanning contrast".	• Contrast Range: Lighter/ <u>Standard</u> /Darker • Contrast: 1, 2, 3, 4, 5, <u>Auto</u>
	Reproduction Size Change the default setting for the "size".	<u>100%</u> , Auto
	Print Speed Change the default setting for the "print speed". When "ECO mode" is set to "ON", this setting is locked at "3".	1, 2, <u>3</u> , 4, 5
	Print Density Change the default settings for the "print density". When "ECO mode" is set to "ON", Print Density Level is locked at "Lighter" and Print Density is locked at "1".	• Print Density Level: Lighter/ <u>Standard</u> /Darker • Print Density: 1, 2, <u>3</u> , 4, 5
	Scanning Side -ADF* If the machine is equipped with the optional Auto Document Feeder DX-1, select the default scanning side for simplex original using "Scanning Side -ADF". ☞ p.156	<u>Front Side</u> -> <u>Simplex</u> , Back Side -> Simplex
	OP Auto Process* Change the default setting for the "Auto Process" when an optional ADF unit or Job Separator is installed.	<u>ON</u> , OFF

Display Access Button	Functions	Description
<b>[Default]</b>	ADF Semi-Auto* Change the default setting for the “ADF Semi-Auto” when the ADF unit (option) is installed.	ON, <u>OFF</u>
	Auto Process Mode Change the default setting for the “Auto Process”.	ON, <u>OFF</u>
	Double Feed Check Change the default setting for the “D-Feed Check”.	<u>ON</u> , OFF
	Job Separation* Change the default setting for the “Job Separation” when the Job Separator (option) is installed.	ON, <u>OFF</u>
	Jump Wing Control Change the default positioning of the Paper Jumping Wing.  <b>Important!:</b> <ul style="list-style-type: none"> <li>This option is available only when the special paper setting is pre-configured. Contact your dealer (or authorized service representative) to pre-configure this setting.</li> </ul>	ON, <u>OFF</u>
	Paper Ejection Adj Change the default settings for “Paper Ejection Adj”.	Air Blow: <u>ON</u> , OFF Separation Fan: OFF, 1, 2, 3, <u>4</u> Pre-suction Fan: ON, <u>OFF</u> Suction Fan: 1, 2, 3, <u>4</u>
<b>[System]</b>	Custom Paper Entry Specify paper dimensions before using non-standard sized paper.	p.178
	Irregular Fitter Specifies to scan custom-size originals as standard-sized.	SE9480U: <u>OFF</u> , Ledger, Legal, Letter, LetterR, Statement SE9380: <u>OFF</u> , A3, B4, A4, A4R, B5, B5R, Foolscap
	Folder Renaming* When the optional Document Storage Card is attached, changes the name of the folder used to save data.	6 folders
	CI Select Choose between “Internal CI” and “External CI” settings. If the machine is equipped with the optional IS300, select “External CI”.	<u>Internal CI</u> , External CI

Display Access Button	Functions	Description
<b>[System]</b>	<p>External CI Info *</p> <p>If the machine is equipped with the optional IS300, set the IP address to connect the machine to the network. IP address settings differ depending on the type of network.</p> <p><b>Note:</b></p> <ul style="list-style-type: none"> <li>To change an input source, touch the applicable box, or press the  key to rotate options.</li> <li>If the message “Network Communication is Not Possible” is displayed when touching <b>[External CI Info]</b>, touch <b>[Cancel]</b> and wait for the IS300 to finish starting up, and then try again.</li> </ul>	<ul style="list-style-type: none"> <li>When using a DHCP server <b>[Use DHCP]</b></li> <li>When entering IP address manually <b>[Manual Input]</b>   or the Print Quantity Keys.</li> </ul>
	<p>Base IP Address</p> <p>Set the IP address for connecting the machine to a network. IP address settings differ depending on the type of network.</p> <p><b>Note:</b></p> <ul style="list-style-type: none"> <li>To change an input source, touch the applicable box, or press the  key to rotate options.</li> <li>If the message “Starting Up Network Card” is displayed when touching <b>[Base IP Address]</b>, touch <b>[Cancel]</b> and wait for the RISO Network Card to finish starting up (approx. 1 minute), and then try again.</li> </ul>	
	<p>Margin-Plus Rate</p> <p>Specify default size-reduction rate for the “Margin+” setting.</p>	<p>90 to 99 % (Factory default is 94%)</p>
	<p>Auto 90°Rotation</p> <p>When setting an original of the same size but with a different orientation from that of the paper loaded in the Paper Feed Tray, on the Glass Platen or the optional ADF unit, the 90-degree rotation setting can be used to align original and output documents.</p>	<p><b><u>ON</u></b>, OFF</p>
	<p>Clock/Calendar</p> <p>Set the internal clock of the machine. The time/date displays on the  Info Screen.  p.203</p>	<p>Year/Month/Day Hour:Minute</p>
	<p>Multi-Up Interval</p> <p>Select the interval time (seconds) between first and second scans when using Multi-Up Printing.</p>	<p><b><u>15s</u></b>, 30s</p>
	<p>Reserve Period</p> <p>Selects a duration of time (seconds) for an inactive machine to receive data from a computer, but restricts processing any output command.</p>	<p>OFF/<b><u>15s</u></b>/30s/60s</p>
	<p>Ex. Reserve Period</p> <p>When “Reserve Period” is set, extends the Reserve Period (minutes) to prevent data interruption.</p>	<p><b><u>5mn</u></b>/10mn/30mn</p>

Display Access Button	Functions	Description
<b>[System]</b>	<p>Auto Clear Select whether to reset all settings to default automatically when the machine is inactive for a set period (minutes). The “Renew Page” function cannot be used after executing “Auto Clear”. If you use “Renew Page” frequently, we recommend setting this to “OFF”.</p>	<ul style="list-style-type: none"> <li>• Auto Clear <b>OFF/<u>ON</u></b></li> <li>• Waiting Time 1-60 mn (factory default is 5 mn)</li> </ul>
	<p>Energy Saving Mode Select to activate Sleep Mode or Shutdown Power when the machine is inactive for a set period of time.</p> <ul style="list-style-type: none"> <li>• OFF “Energy Saving Mode” is not activated. Power is turned ON/OFF using the power switch.</li> <li>• Auto Sleep The machine is standing by to receive data from the computer, but the rest of its functions are powered off.</li> <li>• Auto Power-OFF Automatically shuts the power off. (Data cannot be received.)</li> </ul>	<ul style="list-style-type: none"> <li>• Energy Saving Mode <b>OFF/<u>Auto Sleep</u>/Auto Power-OFF</b></li> <li>• Waiting Time 1-99 mn (factory default is 5 mn)</li> </ul>
	<p>Power-OFF Schedule Set a time of the day to automatically turn off the power to the machine. If the machine is in use, or receiving data, power will not shut off.</p>	<ul style="list-style-type: none"> <li>• Power-OFF Schedule <b><u>OFF</u>/ON</b></li> <li>• Shut-Off time Hour: Minute</li> </ul>
	<p>ECO mode Operate the LCD panel brightness and printing pressure at lower levels than when printing normally and print with minimized power consumption. When “ECO mode” is set to “ON”, the default values of “Print Speed” and “Print Density” cannot be changed. When the machine is set to ECO mode, the “ ECO mode” icon is displayed in the Message Area.</p> <p><b>Note:</b> When using “ECO mode” in combination with any of the following functions, display of the “ ECO mode” icon is omitted.</p> <ul style="list-style-type: none"> <li>• “Ink Saving”</li> <li>• “Program” and “Output reversal”</li> <li>• “Program” and “Layout”</li> </ul>	<p><b><u>OFF</u>/ON</b></p>

Display Access Button	Functions	Description
<b>[System]</b>	<p>User Management Set the User Management function.</p> <ul style="list-style-type: none"> <li>• Management Level Set the “Management Level”.</li> <li>• Create User Register the administrator and users of this machine.</li> <li>• Rename Group Change the group name.</li> <li>• Reset Counter Reset all user counters for master-making/printing.</li> <li>• Recognized by Set the Recognition and Identification System.</li> </ul>	p.114
	<p>Protect Determine the “Protect” setting. p.182</p>	<b>OFF</b> , ON
	<p>Auto Idling Select whether to perform “Auto Idling” when making a master after a set period of non-use. Also selects a period of non-use before initiating “Auto Idling”, as well as the number of idle rotations.</p>	<ul style="list-style-type: none"> <li>• Auto Idling <b>OFF/ON</b></li> <li>• Non-Use Time <b>1-12 hour</b></li> <li>• Rotation <b>1-3</b> (times)</li> </ul>
	<p>Auto Page Renewal Allows you to set when to recreate a new master. Once the specified number of copies reached, the master in use is automatically discarded and a new one is created. You can also specify the number of proof copies to make after recreating the master.</p>	<ul style="list-style-type: none"> <li>• Auto Page Renewal <b>OFF</b>, ON</li> <li>• Auto Renewal Point 1-9999 copies (Factory default is 1000 copies)</li> <li>• Sample Copy Output 0-99 copies (Factory default is 3 copies)</li> </ul>
	<p>Minimum Print Q'ty Set minimum number of copies to print. This prevents creation of master when a smaller quantity is entered for printing.</p> <p><b>Important!:</b></p> <ul style="list-style-type: none"> <li>• This setting can be locked to prevent alteration. Consult your dealer (or authorized service representative) for details.</li> </ul>	<b>OFF/ON</b> (2-99 copies)
	<p>Stock Management In order to check current stock quantity, insert the number of consumables purchased. When stock quantity falls below the “Remaining Qty to be notified”, a message will appear on the display.</p> <p><b>Note:</b></p> <ul style="list-style-type: none"> <li>• To switch an entry, directly touch the button or press the  key.</li> </ul>	<ul style="list-style-type: none"> <li>• Purchase Qty <b>0-99</b> Pcs.</li> <li>• Remaining Qty to be notified <b>0-99</b> Pcs.</li> </ul>

Display Access Button	Functions	Description
<p>[System]</p>	<p>Beep Sound Select whether to activate a beep sound when a key/button is pressed, or when an error occurs.</p> <ul style="list-style-type: none"> <li>• ON Beeps when any key/button is pressed. Beeps when an event occurs/is completed.</li> <li>• Limited Does not beep when keys/buttons are pressed. Does not beep when restarting the machine.</li> <li>• OFF Does not beep.</li> </ul>	<p>OFF/Limited/<u>ON</u></p>
	<p>Print Colors</p>	<p>☞ See RISO Editor User's Guide for details.</p>
	<p>Tool Bar Position</p>	
	<p>Sub Tool Bar</p>	
<p>Page Orientation</p>		

## Customizing Default Settings

The default settings can be changed when the machine is not in operation. Make sure there is no pending or current Print Job operation.

### Note:

- If the administrator is registered in User Management, only the administrator can change the [Admin.] settings. (This operation requires input of the administrator's PIN Code or connection of the registered USB Flash Drive.)  
p.120
- On the Admin. Screen, the current setting is displayed on the right side of each button.

### 1 Touch [Admin.] on the Basic Screen for each mode.

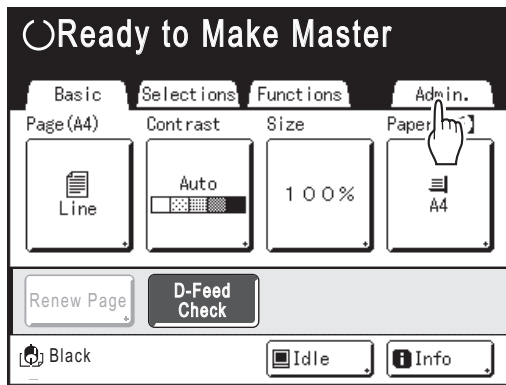

### 2 Touch [OK].



### Note:

- When an administrator is registered in User Management, the Recognition Screen is displayed. Operate the screen to log in as the administrator. If already identified as the administrator, the Recognition Screen will not be displayed. Users other than administrator are prohibited.

### ◆ When “Recognized by” is set to “PIN Code”

Input the administrator's PIN Code using the Print Quantity Keys and touch [OK].

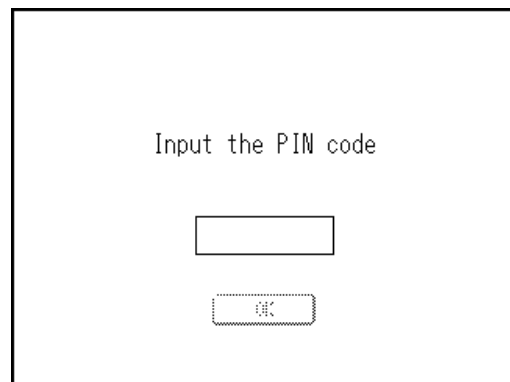

### ◆ When “Recognized by” is set to “USB Flash Drive”

Connect the administrator's registered USB Flash Drive to the USB slot.

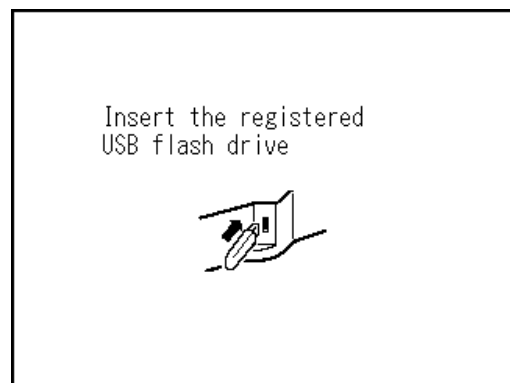

The Admin. Screen is displayed once access has been identified.

### 3 Select a function to modify.

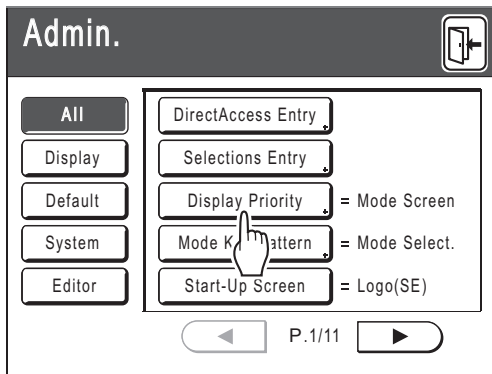

#### Display Access Buttons

Display Access Buttons allow the quick selection of desired functions by displaying only relevant groups of function buttons.

**[All]**: All Functions

**[Display]**: Functions related to Screen Display

**[Default]**: Basic Operational Functions

**[System]**: Functions affecting the entire System

**[Editor]**: Functions related to Editor

### 4 Change settings.

Some functions have their own Setup Screens, some don't. There are several styles for setting values. Following samples demonstrate different value setting styles.

#### ◆ No additional Setup Screen

(2 or more options to choose from)

Touch the function name button to change the value displayed to the right.

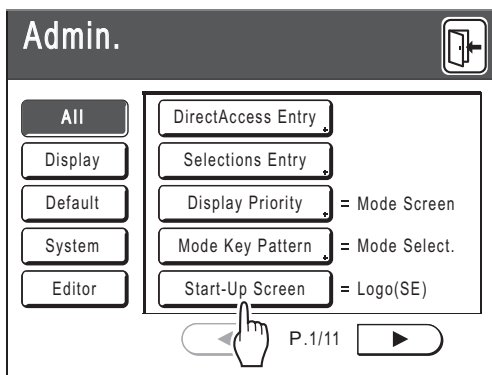

#### ◆ Additional Setup Screen Available

##### Button Style

Choosing a button makes it default.

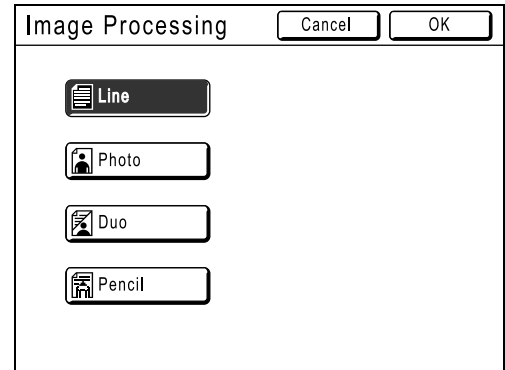

#### ◆ Additional Setup Screen Available

##### Numeric Value Style

Touch ▲ ▼ to increase/decrease value.

Numbers may be entered using the Print Quantity Keys.

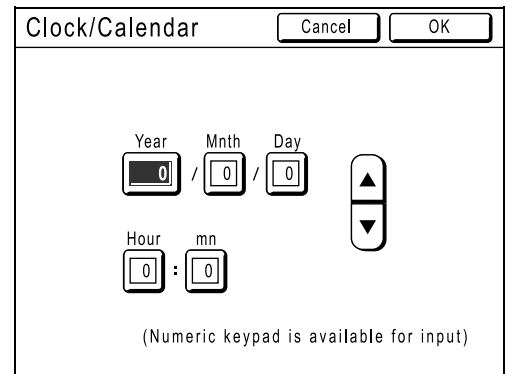

#### ◆ Additional Setup Screen Available

##### Multi Level Entry Style

Select a button, then set its values either by touching more buttons or entering a value numerically.

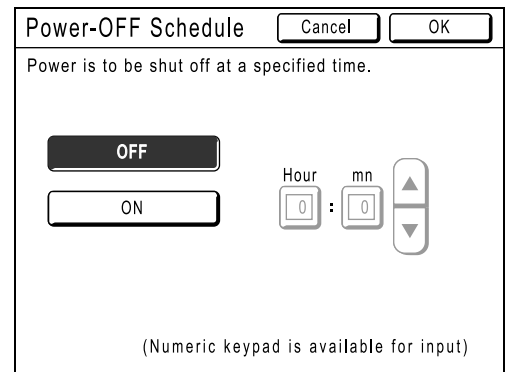



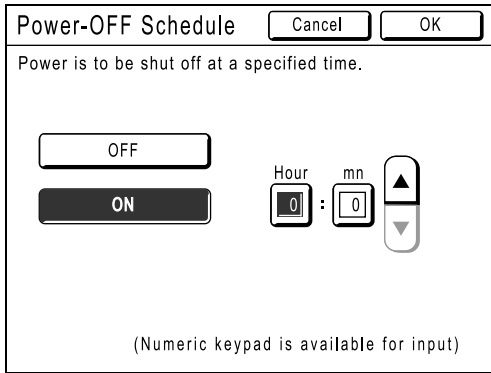

Touch [ON] to display more options on the right.

◆ Additional Setup Screen Available

**Text Input Type**

Input the name after touching the button whose name to be changed.

Touch the button and the Rename Screen appears.

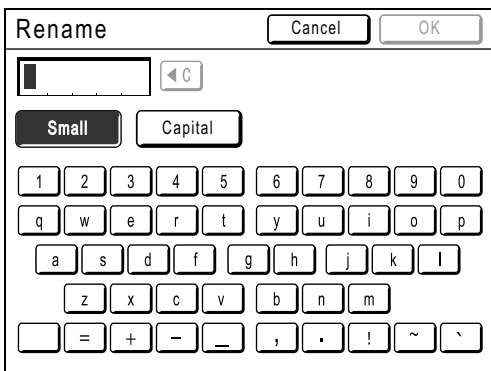
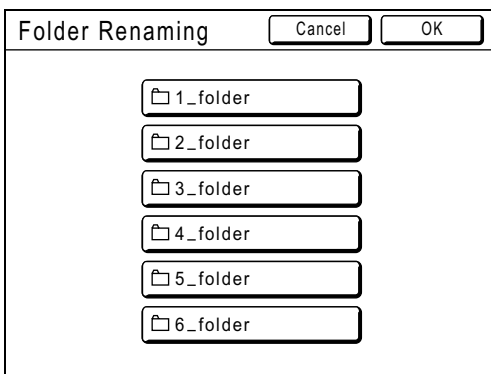

Touch the character buttons to enter text.  
 Change capitalization by selecting [Small] or [Capital] button.

☞ p.136

◆ Additional Setup Screen Available

**Data Specification Type**

A screen to specify the stored data is displayed.

See ☞ p.193 for details on specifying the data.

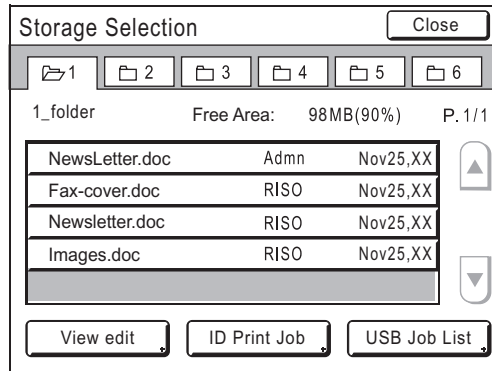

5 Touch [OK].

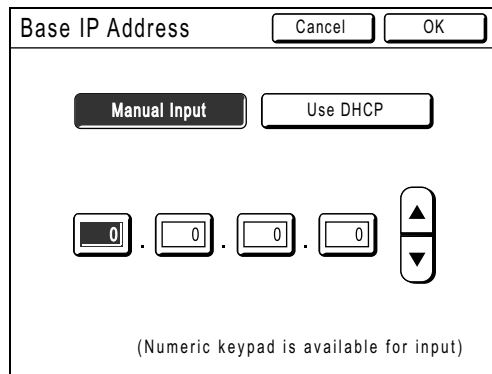

Skip to step 6 if there is no additional Setup Screen.

**Note:**

- Touch [Cancel] to cancel the changes and return to the Admin. Screen.
- The selected value is displayed to the right side of the button (for most functions).

6 Touch [Return].

Returns to the original Basic Screen.

# Setting Up Direct Access Area and Selections Tab

## [DirectAccess Entry] [Selections Entry]

Frequently-accessed functions for each mode can be placed on “Direct Access” area in the Basic Screen, or on “Selections” Screen.

This allows quick changes and direct access to each function's Setup Screens, eliminating the need to search from a long list of functions.

Each mode (Master Making/Print/Scanning) is capable of storing its own unique settings.

Basic Screen	Master Make	Print	Scanning
Direct Access	4	4	4
Selections	9	9	-

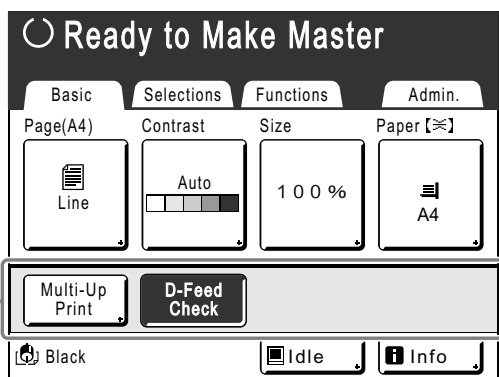

Direct Access Area

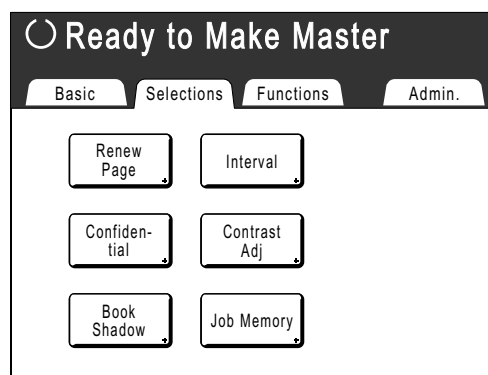

Selections Screen

**Note:**

- Choose functions that are relevant to each mode.
- The machine comes with factory default “Direct Access” area and “Selections” Screen entries, which can be changed.
- Any function available in the “Functions” Screen can be selected.
- Optional attachment is automatically added to the “Direct Access” area and “Selections” tab if a space is available for another button.
- When the Management Level is set to “High/Full Management”, each user can set the functions displayed in the Direct Access Area (My Direct Access). [p.164](#)

In the following steps, the registration on DirectAccess Entry and Selections Entry are explained at the same time.

## 1 Touch [DirectAccess Entry] or [Selections Entry] on the Admin. Screen.

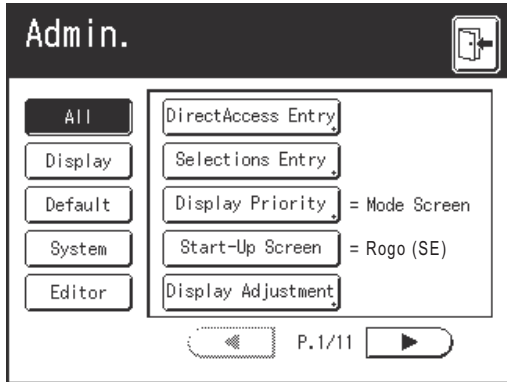

## 2 Select a mode tab to store new buttons.

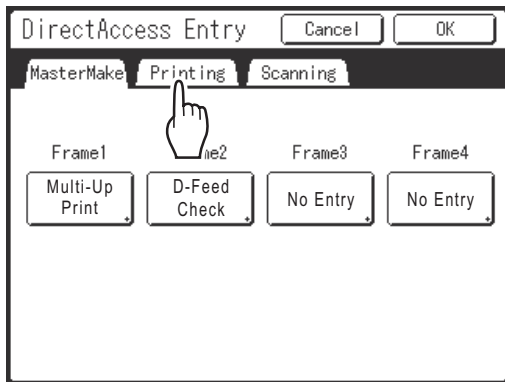

## 3 Select a button to assign a function.

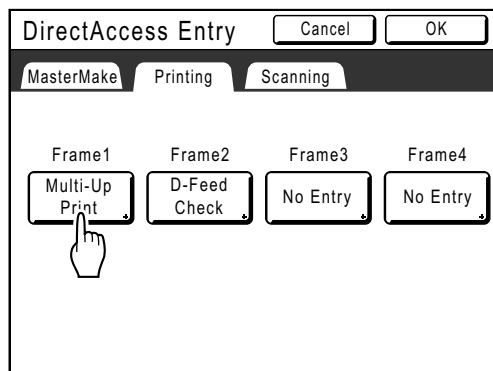

If the button has a function already assigned to it, the newly selected function will overwrite the previous function.

## 4 Select a function to assign.

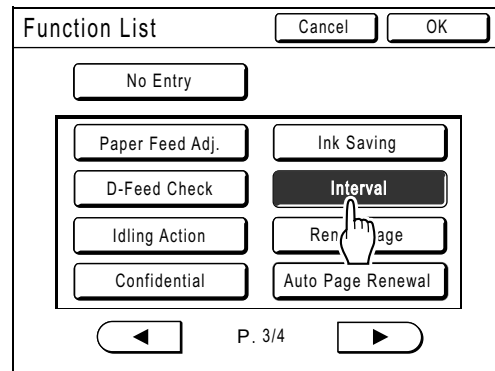

### Note:

- Touch ◀ or ▶ to display more functions, if necessary.
- To remove a function accidentally assigned, touch **[No Entry]**.
- Functions already assigned are grayed out and not available for selection.
- Some functions display only when optional devices are installed.

## 5 Touch [OK].

Returns to DirectAccess Entry Screen or Selections Entry Screen. The selected functions are added.

To add more functions, or to replace a button with another function, repeat steps 2-5.

## 6 Touch [OK].

Returns to the Admin. Screen. "Direct Access" area or "Selections" Screen is updated.

## 7 Touch .

Returns to the Master Making Basic Screen or Print Basic Screen.

# Registering a Custom Paper Size

## [Custom Paper Entry]

Non-standard paper sizes must be pre-entered into memory. Once a paper size is stored into memory, it can be retrieved with the [Paper] button from the Master Making Basic Screen.

Up to 30 different sizes may be entered. Previously stored sizes can be modified or deleted.

You can register paper sizes between 100 mm × 148 mm ( $3^{15}/_{16}$ " ×  $5^{13}/_{16}$ "") to 340 mm × 555 mm ( $13^{19}/_{32}$ " ×  $21^{27}/_{32}$ ""). However, any paper longer than 436 mm ( $17^5/_{32}$ "") prints in extended paper mode.

☞ p.180

### Important!:

- Custom paper sizes must be entered. Failure to do so may result in incorrect scanning.

## Entering sizes and changing names

- 1 Touch [Admin.] on the Basic Screen for each mode.

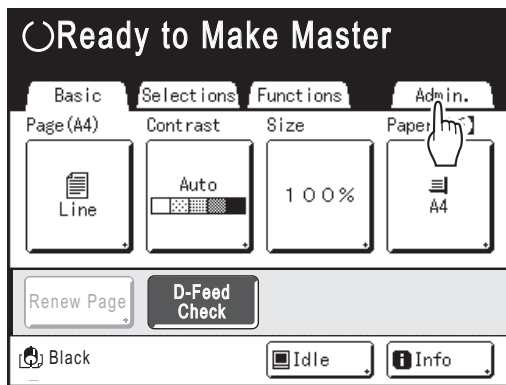

- 2 Touch [OK].

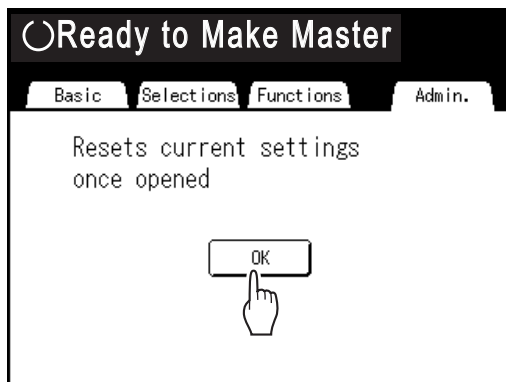

If the Recognition Screen is displayed, follow the message on the screen. See step 2 in "Customizing Default Settings". (☞ p.173)

- 3 Touch [System] or [Next] to display [Custom Paper Entry] on the screen.

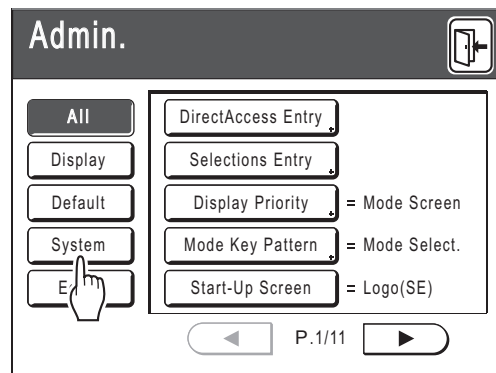

- 4 Touch [Custom Paper Entry].

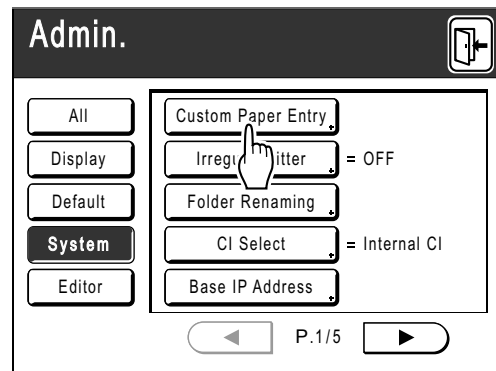

## 5 Touch an unused button.

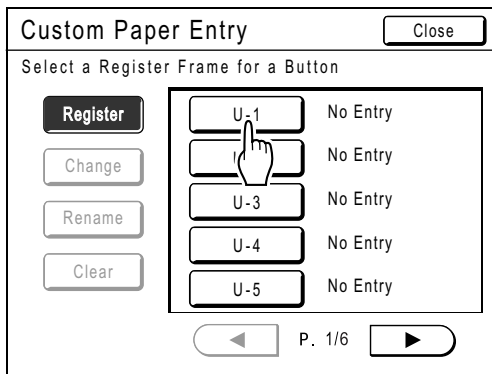

Unused buttons are displayed with a solid line. Used buttons are grayed out and are not available.

## 6 Enter the paper size.

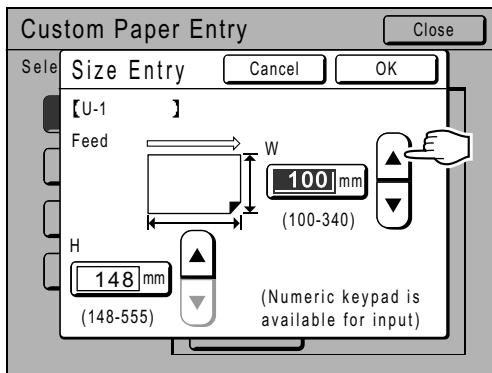

Facing the paper feeding direction (into Feed Tray), enter W (width) and H (height). Touch either , or use Print Quantity Keys.

## 7 Touch [OK].

**Rename as necessary.**

Touch [Close] to skip renaming the size.

## 8 Touch [Rename].

## 9 Select a button to rename.

## 10 Touch character buttons to enter a new name.

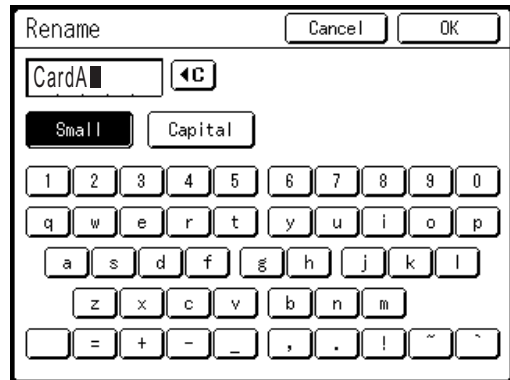

Change capitalization by selecting [Small] or [Capital] button.

p.136

**Note:**

- To clear the current name, touch button or press the key.

## 11 Touch [OK] when done.

**Note:**

- To change a name, repeat from step 8.

## 12 Confirm the name and touch [Close].

Returns to the Admin. Screen. Feed Tray (Paper) is updated.

**Tip:**

**Printing on Extended Paper**

The machine can print on paper 436 mm-555 mm ( $17\frac{5}{32}$ "- $21\frac{27}{32}$ " ) long (top to bottom facing the paper feeding direction) by storing the size as a custom-size.

☞ p.178

When entering a size longer than 436 mm ( $17\frac{5}{32}$ " ) (top to bottom facing the paper feed direction) on the Custom Paper Entry Screen, the paper will be treated as "Extended Paper".

When "Extended Paper" is selected on the Feed Tray (Paper) screen, the machine switches into "Extended Paper" mode.

**Important!:**

- Some Extended Paper may fail to pass through the machine due to its paper characteristics, or may get smudged with Ink due to its image positioning. Consult your dealer (or authorized service representative) for advice.

**"Extended Paper" Mode**

- When the machine is on "Extended Paper" mode, it is indicated in the message area as either "Ready to Make Master <Ext.Paper>" or "Ready to Print <Ext.Paper>".
- On "Extended Paper" mode, the machine can print papers measuring 436 mm-555 mm ( $17\frac{5}{32}$ "- $21\frac{27}{32}$ " ) lengthwise from top to bottom facing the paper feed direction. However, maximum printing area and top/bottom Print Positioning range remains as usual.  
☞ p.19  
☞ p.100
- Print timing and speed is different on "Extended Paper" mode in comparison to normal printing. This is to be expected, so do not be alarmed.
- Contact your dealer (or authorized service representative) for suggestions about placing paper on the Paper Receiving Trays when on "Extended Paper" mode.

## Deleting a Custom Paper Size

- 1 Touch [Admin.] on the Basic Screen for each mode.

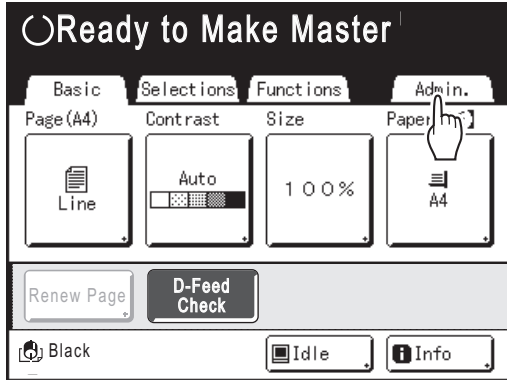

- 2 Touch [OK].



- 3 Touch [Custom Paper Entry] on the Admin. Screen.

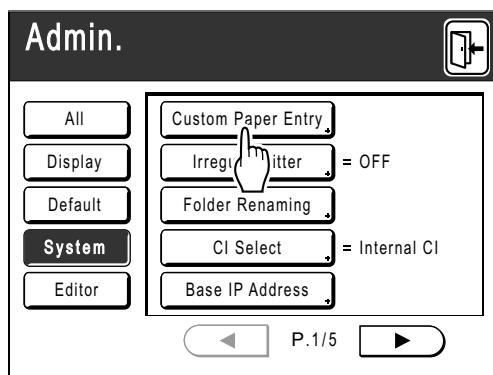

- 4 Touch [Clear].

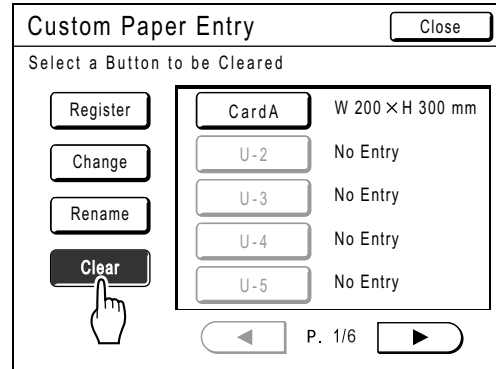

- 5 Select the paper size to delete.

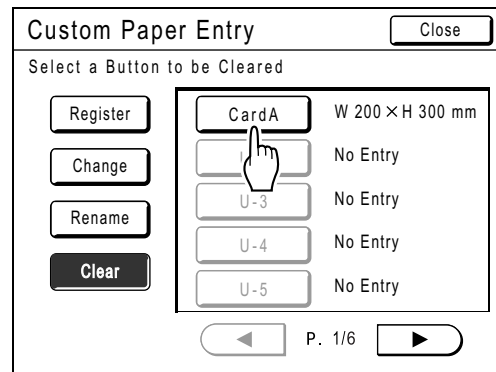

- 6 Touch [OK].

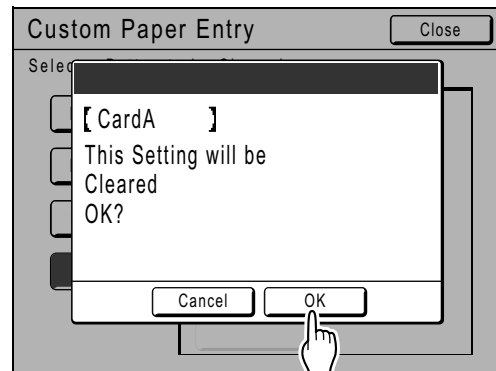

Returns to the Custom Paper Entry Screen. The selected paper size is deleted.

- 7 Touch [Close].

Returns to the Admin. Screen. Paper size is updated.

# Keeping Masters Secure After Printing

## [Protect]

After printing is completed, the master remains on the Print Drum (Cylinder). To protect confidential documents from unauthorized duplication, use the Confidential feature to discard the master after printing. (i.e. “Confidential” function) Used masters are held in the Master Disposal Box. The machine is equipped with a protection function to prevent the master from being removed from the Master Disposal Box and leaked by any ill-intended third party.

### “Protect” Setting

When the “Protect” setting is ON:

- When printing is complete, the “Confidential” function is activated to show the message to discard the master remaining on the Print Drum (Cylinder).
- The Master Disposal Box is locked and cannot be removed while the machine is in standby. (However, the Master Disposal Box can be unlocked and removed if the master is jammed in the Disposal Unit or the Master Disposal Box is full.)

### Locking the Master Disposal Box

To prevent any leak of master documents after printing, the Master Disposal Box can be locked with a padlock so that no-one apart from the administrator of the machine can remove it. (Purchase an ordinary padlock whose loop will fit through the hole, which is 7 mm (<sup>9</sup>/<sub>32</sub>" ) wide.)

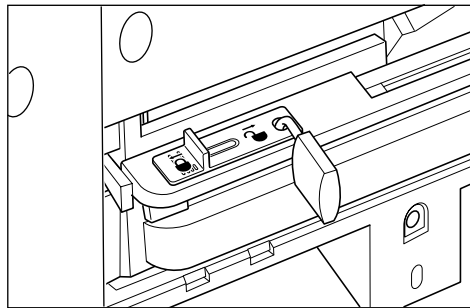

### Status of Protect functions and restrictions

Status of [Protect] functions	Restrictions
Protect: OFF Padlock: No	No restrictions on printer access <sup>*1</sup>
Protect: ON Padlock: No	“Confidential” message is displayed Master Disposal Box is locked <sup>*2</sup>
Protect: OFF Padlock: Locked	No “Confidential” message is displayed Nobody but the administrator can dispose of the master.
Protect: ON Padlock: Locked	“Confidential” message is displayed Nobody but the administrator can dispose of the master.

\*1 The ordinary “Confidential” function is available.

\*2 The lock is released if a master jams in the Disposal Unit or if the Master Disposal Box becomes full.



# Preventing Leaks of Masters After Creation or Disposal

## Turning the Protect Setting ON

- 1 Touch **[Admin.]** on the Basic Screen for each mode.

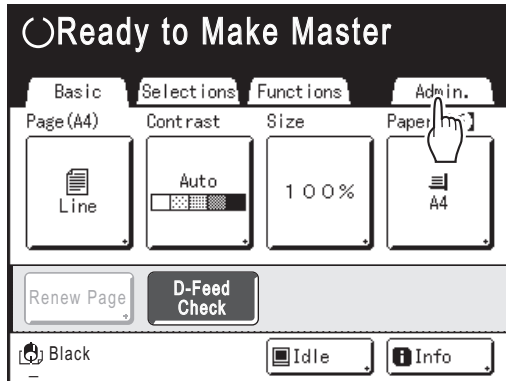

- 2 Touch **[OK]**.



If the Recognition Screen is displayed, follow the message on the screen. See step 2 in "Customizing Default Settings". (p.173)

- 3 Touch **[Protect]**.

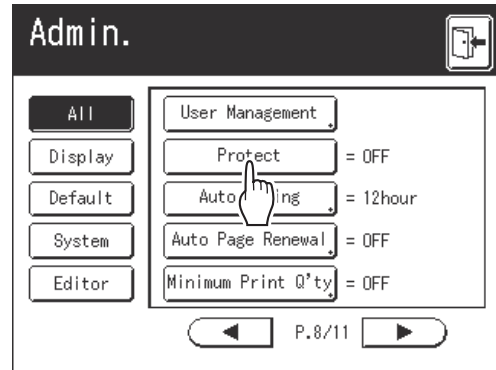

"Protect" is turned ON.

### Note:

- When "Protect" is set to "ON", "Energy Saving Mode" (Auto Sleep or Auto Power-OFF) is automatically set to ON and the waiting time is set to one minute. (The set time cannot be changed.)
- If "Protect" is ON, **[Renew Page]** is grayed out and not available.

## If “Protect” is ON

The following screen is displayed after printing.

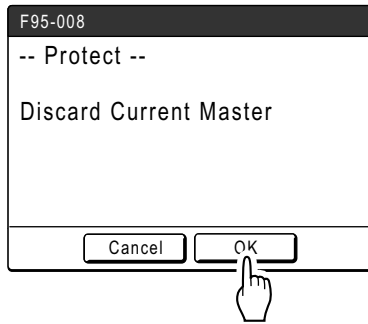



Touch **[OK]** or **[Cancel]**.

**[OK]:** Discards the master remaining on the Print Drum (Cylinder).

**[Cancel]:** Choose this when you do not wish to discard the master or wish to print further copies.

### Note:

- The “-- Protect -- Discard Current Master” message is also displayed when printing from computer data on a PC.
- If you select **[Cancel]** while the “Protect” setting is active, the “-- Protect -- Discard Current Master” message is on appears each time you press  key or  key.
- The screen shows the message below when:
  - setting the Print Drum (Cylinder) that has been removed without the “Confidential” operation, or
  - the machine goes into the sleep mode after a certain period of time has passed after the confirmation message was displayed, and then the sleep mode is cancelled (or the power is turned ON).

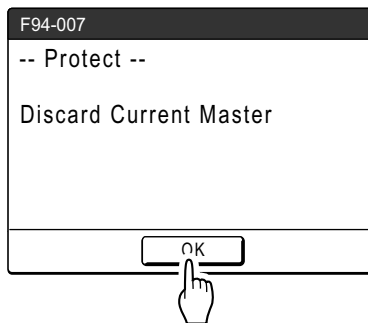

Touch **[OK]** to discard the master remaining on the Print Drum (Cylinder).

## Cancel the “Protect” setting

Only the administrator can cancel the “Protect” setting.

### 1 Touch [Admin.] on the Basic Screen for each mode.

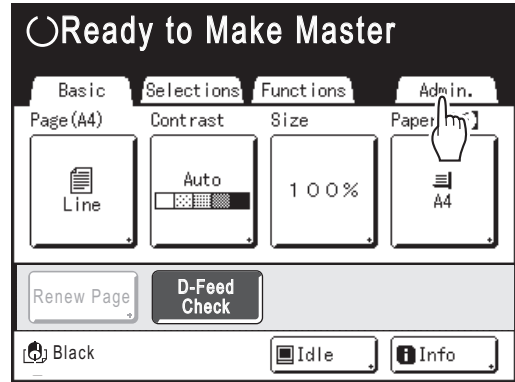

### 2 Touch [OK].



If the Recognition Screen is displayed, follow the message on the screen. See step 2 in “Customizing Default Settings”. (p.173)

### 3 Touch [Protect].

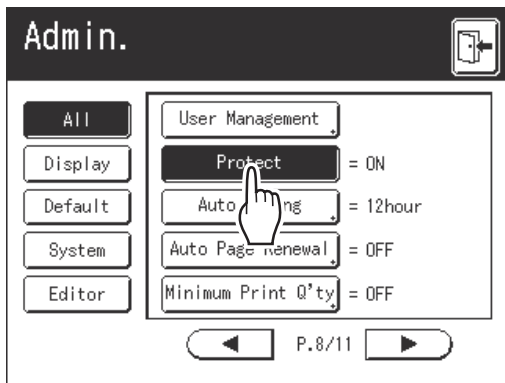

After a "Please Wait a Moment" message is displayed, the "Protect" setting is canceled.

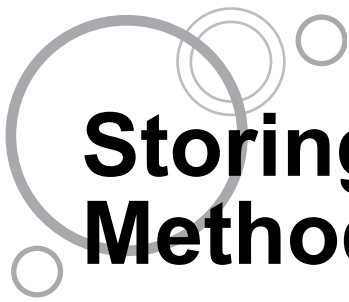

# Storing Original Data and Use Method

The machine can store original data. To use this function, the optional Document Storage Card or USB Flash Drive is required.

Stored original data can be repeatedly retrieved for printing.

There are two methods of storing original data: "Storage Memory" and "USB Flash Drive". "Storage Memory" allows you to store original data on the internal optional Document Storage Card of the printing machine. "USB Flash Drive" allows you to store original data in a USB Flash Drive. Both methods can store original data as follows.

- Storing data from a hard-copy original by using the scanner of the machine.
- Storing original data created on a computer.

The methods of storing data from a hard-copy original and printing the stored original data are explained here. Details on how to store the data created on a computer, see the "RISO Printer Driver User's Guide" (CD-ROM).

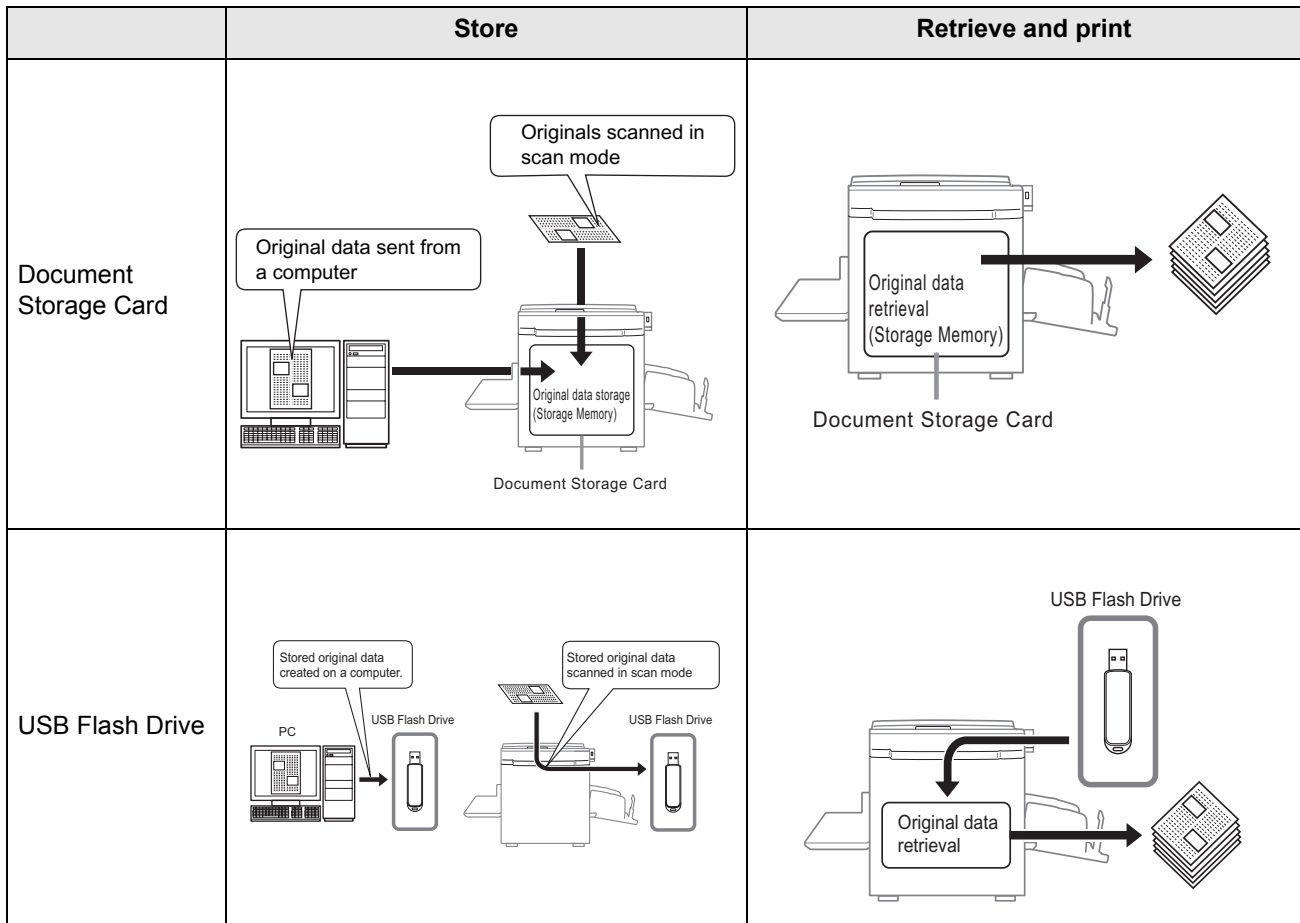

- The following operations are available with data stored in “Storage Memory” or “USB Flash Drive”.
  - Stored original data can be repeatedly retrieved for printing.
  - If the storage data contains multiple pages, you can choose to output only odd or even pages, or indicate the specific pages to print using “Output”.  
☞ p.196
  - The storage data also can be overlaid onto a hard-copy original and printed.  
☞ p.193
- All users of this machine can use the 6 folders in “Storage Memory”. It is convenient to store and use the data in common with others.
- 6 folders are created in each “USB Flash Drive”. Use the folders as needed, when selecting a folder for storing any specified data.

**Important!:**

- We cannot guarantee storage data or USB Flash Drive data against losses occurred by accidents or unforeseen events. We recommend that you use your computer to make back-up copies of any important documents.

**Note:**

- You can easily delete unnecessarily stored data when the remaining free space of the optional Document Storage Card or USB Flash Drive is limited. The free space is displayed in the Storage Selection Screen or USB Job List Screen.  
☞ p.196
- As to the folder for storing original data, 6 folders are prepared for the optional Document Storage Card and 6 folders are prepared for each memory in the case of USB Flash Drives. When you use folders to share data, you are recommended to devise folder rules (e.g. dividing the folders by department or type of data)
- Folder names of the optional Document Storage Card can be changed on the Admin. Screen.  
☞ p.168
- To change folder names of the USB Flash Drives, use the “RISO Utility Software” (RISO USB PRINT MANAGER) included in the provided software CD-ROM. (If you change folder names by Explorer, they will not be recognized by the machine) For details, see the “RISO Utility Software User's Guide” (CD-ROM).
- You can change the order of the storage data and USB Flash Drive data.  
☞ p.195

# Converting Hard-copies to Stored Data

## [Scan Mode]

Scan mode is a function that allows you to scan a hard-copy original with the machine's scanner to save as storage data or USB Flash Drive data.

You can repeatedly retrieve and print previously scanned and stored original data. This saves you the trouble of re-scanning the documents when repeatedly printing the same materials.

[p.186](#)

This function also prevents documents from getting lost or damaged over time.

### Important!:

- The storage function is not available in the machine equipped with the optional RISO IS300 controller. The data scanned in the Scan Mode is stored in IS300.

### Note:

- Delete unnecessary stored data when the remaining free space of the optional Document Storage Card or USB Flash Drive is limited. The free space is displayed in the Storage Selection Screen or USB Job List Screen.

[p.196](#)

The following functions can be used in scan mode: See the explanation of each function for more details.

- Image ([p.58](#))
- Contrast ([p.60](#))
- Size (enlargement/reduction) ([p.61](#))
- Dot Process ([p.67](#))
- Contrast Adj ([p.68](#))
- Tone Curve ([p.69](#))
- 2 Up/Multi-Up Print ([p.71](#))
- Preview ([p.92](#))
- Book Shadow ([p.84](#))
- Layout ([p.80](#))
- Scanning Side - ADF ([p.158](#))
- My Direct Access ([p.164](#))

The following functions are specific to scan mode.

- Format ([p.192](#))

## Scanning a Hard-copy Original

### 1 Place the original.

Place the original on the Glass Platen or in the optional ADF unit.

To place the original, see [p.41](#).

### 2 Select a scan mode.

Touch **[Scanning]** on the Mode Selection Screen.  
[p.26](#)

The Scan Basic Screen is displayed.

#### Note:

- After selecting the Scan mode and if the following "Format" Screen is displayed, select the page size (original size) and touch **[OK]**.

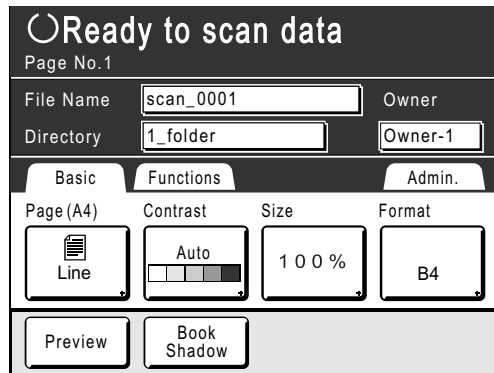
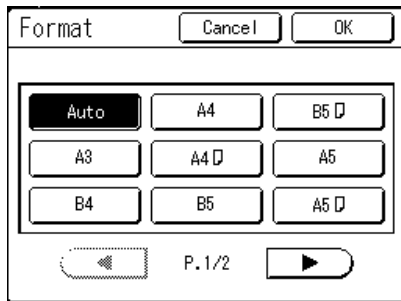

### 3 Setting data information.

Sets the data name, save location and owner name.

[p.190](#)

### 4 Setting required functions.

Set the required functions for scanning the original.

#### Note:

- You can check scanned data instantly by enabling the "Preview" function. You can also use this function to check data before saving.
- See the previous section for the functions that can be set.

#### Important!:

- Set "Format" when scanning custom-sized originals.  
[p.192](#)

### 5 Press the key.

The scan starts.

#### Note:

- After scanning the original, a preview shows on the display if "Preview" is set. Check the image on the display and touch **[Close]**.

### 6 Repeat steps 1, 4 and 5 if the original has multiple pages.

#### Note:

- If multiple originals were placed on the optional ADF unit, all originals will be scanned at the same settings.

### 7 Touch .

Once the original to be saved as one set of data is scanned, touch . A confirmation screen appears.

### 8 Touch **[Yes]**.

The data is saved.

When you touch **[<Back]**, the screen returns to the previous operation.

When you touch **[No]**, the scanned contents are canceled.

#### Note:

- Press the  key to exit scan mode.

# Setting Data Information

Settings for the data to be scanned and stored are configured on the Scan Basic Screen.

The file name, directory and owner name are automatically allocated when scan mode is started, but you can change this preset information if needed.

**Note:**

- Default settings for the “Directory” folder can be changed in “Admin.”. (p.168)

## 1 Enter a file name.

- 1) Touch the file name input box.

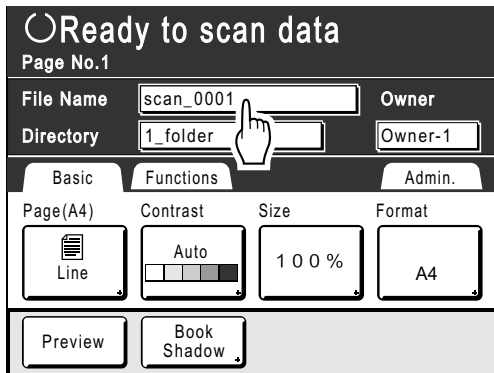

The Rename screen appears.

- 2) Touch the **[C]** button to delete the current name.

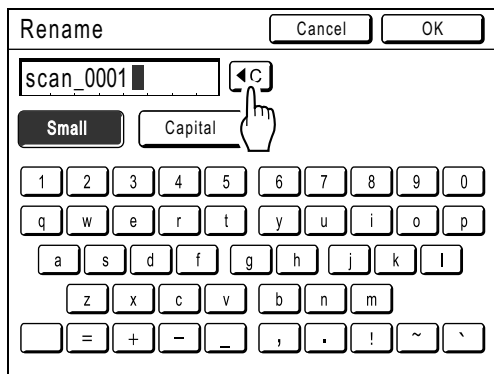

**Note:**

- You can also press the **[C]** key to delete.

- 3) Touch the text button and enter the file name. (p.135)
- 4) Touch **[OK]**.  
The file name is confirmed and the screen returns to the Scan Basic Screen.

## 2 Specifying a Directory

When saving in the USB Flash Drive, connect the USB Flash Drive to the USB slot in advance.

**Note:**

- If the machine is equipped with the optional RISO Controller IS300, you cannot specify where to store the data.

- 1) Touch the directory input box.

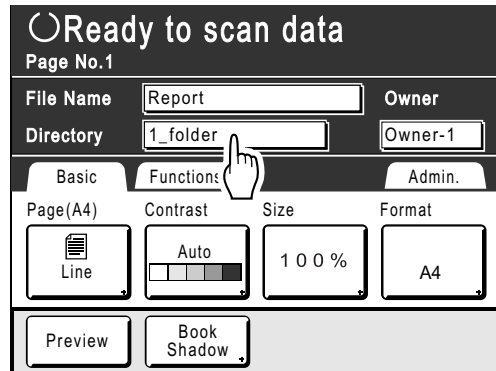

The Directory Screen appears.

- 2) Touch **[Storage Memory]** or **[USB Flash Drive]**.

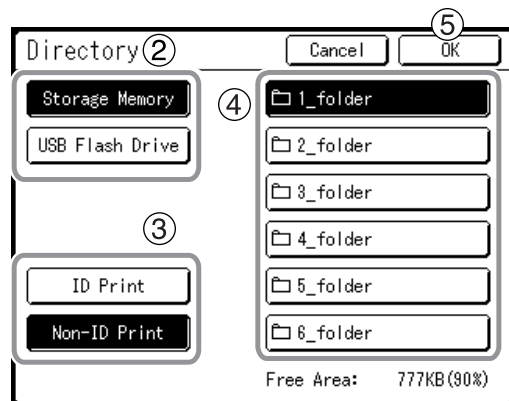



If the USB Flash Drive is not connected, [USB Flash Drive] is grayed out and not available.

- 3) Touch [ID Print] or [Non-ID Print]. [ID Print] and [Non-ID Print] are displayed only when "Management Level" is set to "High/Full Management".
- 4) Touch the folder to save the data.
- 5) Touch [OK].  
The "Directory" folder is confirmed and the screen returns to the Scan Basic Screen.

**Note:**

- The folder name of the "Directory" folder of storage data can be changed in "Admin.". (p.168)

### 3 Specifying an Owner.

- 1) Touch the owner input box.

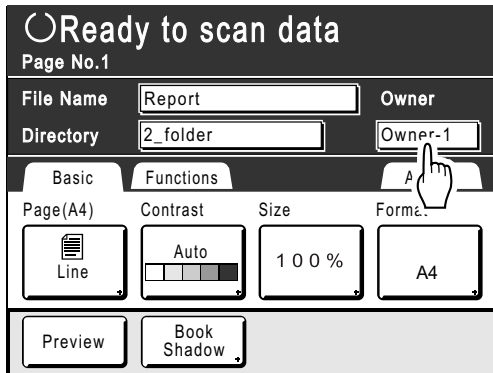

The Owner Screen appears.

- 2) Touch the button of the owner to set.

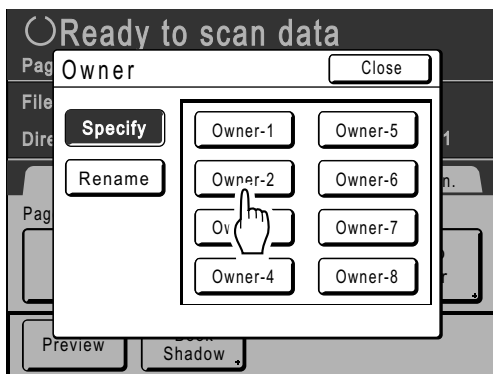

The owner name is confirmed and the screen returns to the Scan Basic Screen.

**Tip:**  
**Changing the Owner Name**

- 1) Touch [Rename] on the Owner Screen.

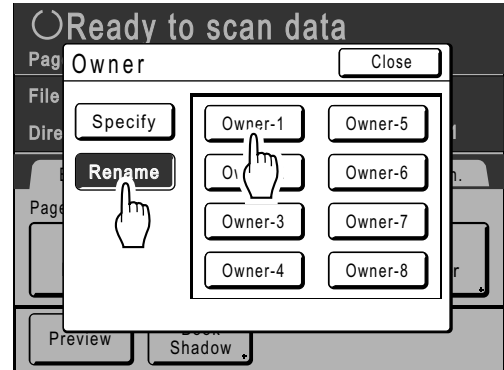

Touch the button of the owner to rename. The Rename Screen appears.

- 2) Touch the [C] button to delete the current name.
- 3) Enter the Owner name.
- 4) Touch [OK].

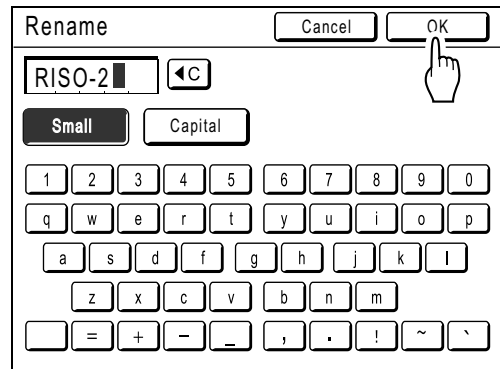

The owner name is confirmed and the screen returns to the Owner Screen.

## Specifying Stored Size

Specify the size to save the scanned original.

It is necessary to set the Format size when:

- you place the originals on the Glass Platen
- you set the custom-sized originals in the optional ADF unit
- you want to save at a size that differs from the size of the original

When the standard-sized original is set in the optional ADF unit, the original size is detected automatically. The original is saved by original format.

### 1 Touch [Format] on the Scan Basic Screen.

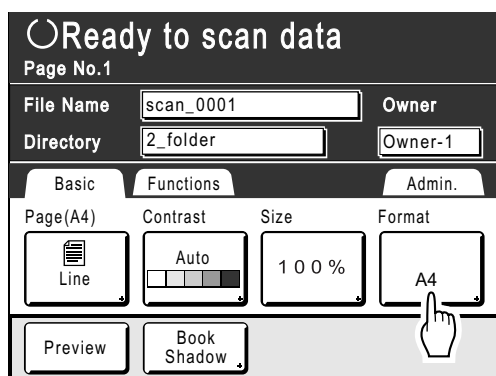

The Format Screen appears.

### 2 Touch the paper size button to be set.

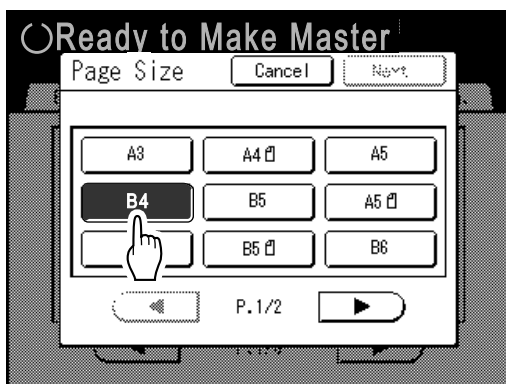

If you select **[Auto]**, the same size as the original will automatically be set.

**Note:**

- When Format is set to “Auto”, you cannot select “Auto” under the Size.

### 3 Touch [OK].

The paper size is confirmed and the screen returns to the Scan Basic Screen.

# Retrieving Stored Data and Printing

## [Storage Memory][USB Job List]

Retrieving and printing stored data.

### Retrieving Stored Data

When retrieving the USB Flash Drive data, connect the USB Flash Drive to the USB slot in advance. For details on how to print USB Flash Drive data, see p.48 “Printing from a Computer Data”.

#### Note:

- When “User Management” is set up by the administrator, the users will be asked to identify themselves during the operation. For details, refer to p.114.
- When “Recognized by” is set to “PIN Code” in User Management and the USB Flash Drive is connected while the Basic Screen for each mode is displayed, the USB Job List Screen is automatically displayed. See step 2.

### 1 Touch [Storage Memory] on the Functions Screen.

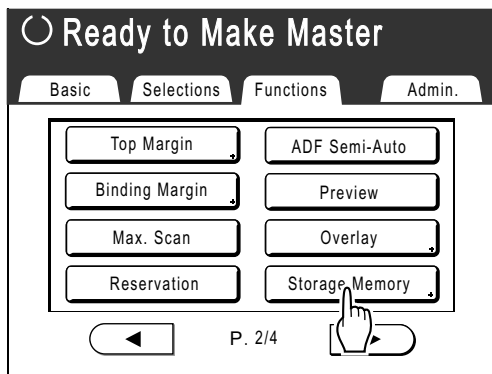

The Storage Selection Screen or USB Job List Screen (with “Non-ID Print”) is displayed (The “ID Print Job” button is displayed on the screen).

### 2 Select [ID Print Job] or [Non-ID Print].

#### Note:

- When “Management Level” is set to “Low/ Admin tab only” in User Management, [ID Print Job] will not be displayed.

#### ◆ When retrieving data set with “ID Print Job”

Touch [ID Print Job].

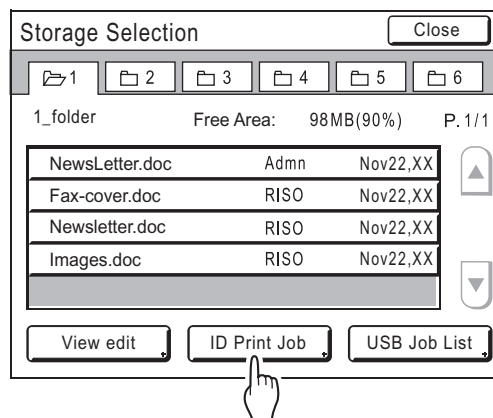

#### ◆ When retrieving data set with “Non-ID Print”

When “Non-ID Print” is displayed on the screen, touch “Non-ID Print”.

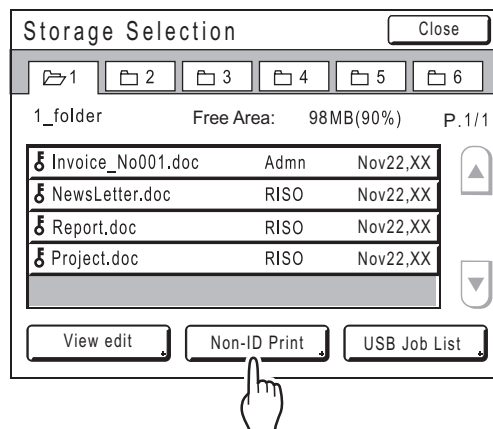

### 3 Touch the stored data to print.

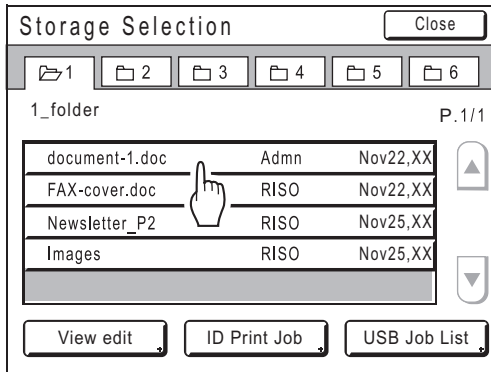

If you are selecting data stored in a different folder, touch that folder's tab.

**Note:**

- If the stored data is not shown on the screen, touch or to display.
- Touching **[USB Job List]** or **[Storage Memory]** displayed in the bottom right corner of the screen switches to the Storage Selection Screen or USB Job List Screen.

### 4 Confirm the retrieved data.

Use the thumbnail to determine whether the retrieved data is the data desired.

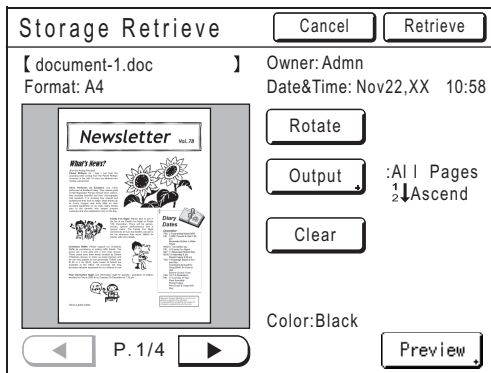

From the Storage (USB Job List) Retrieve Screen, you can confirm retrieved data and specify output settings.

See [p.196](#) for operational details.

**Note:**

- Touch the **[Preview]** when you want to enlarge and confirm the thumbnail.

### 5 Touch [Retrieve].

The data is retrieved and Storage Mode Basic Screen appears.

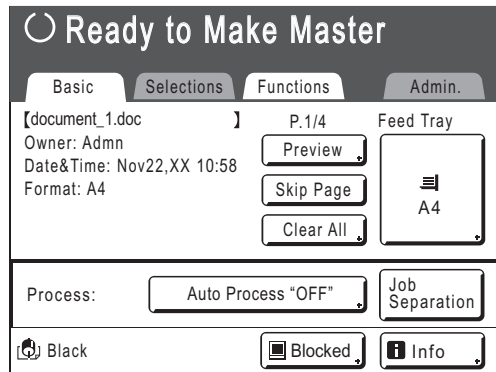

### 6 Press the key.

A master is made from the data.

After this, please follow the same operations for normally making a master/printing.

## Changing the Data Order

You can change the order of the storage data displayed on the storage data Selection Screen.

**Note:**

- The factory setting is “Date Descend”.

### 1 Touch [View edit].

**Note:**

- [View edit] is inactive if there is no storage data/USB Flash Drive data or only one stored item.

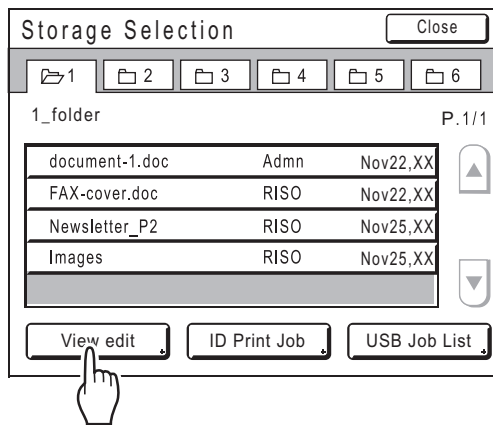

### 2 On the View Edit Screen, touch the button of the order you want.

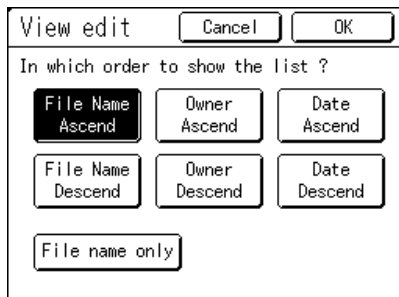

**Note:**

- By using ON (inverted)/OFF of [File name only], the data display format can be switched on the Storage (USB) Selection Screen.

OFF: File Name + Owner Name + Date  
ON (inverted): File Name

### 3 Touch [OK].

Returns to the Storage Selection Screen (USB Job List Screen).

## Using the Storage Retrieve/USB Job List Screen

Each section of the Storage Retrieve/USB Job List Screen is shown below. An example of the Storage Retrieve Screen is explained here.

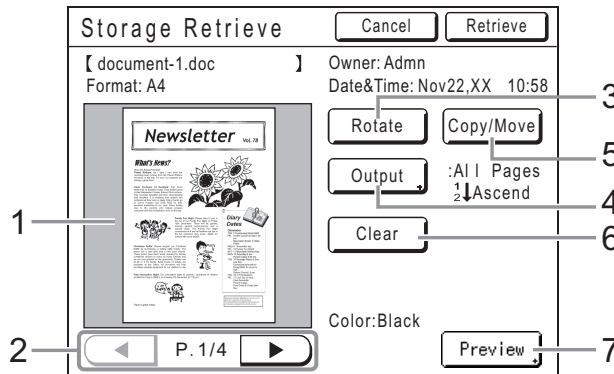

- 1) A thumbnail is displayed for each page.
- 2) If the data contains multiple pages, touch to change page.
- 3) Touch to rotate the storage data/USB Flash Drive data 180 degrees and output.
- 4) **Output Range**

If the storage data consists of multiple pages, you can specify which pages to print. Touch **[Output]** to display the Output Screen.

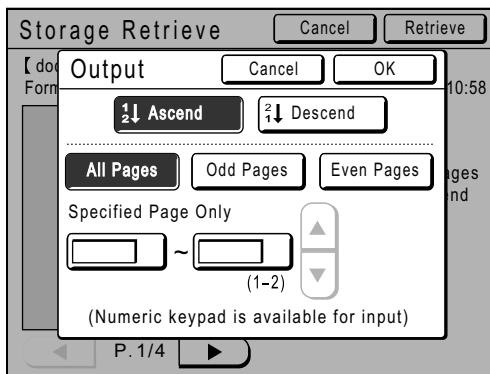

Touch the corresponding buttons to print all pages, only odd pages, or only even pages. You can also specify whether to print the selected pages in **[Ascend]** or **[Descend]** order.

To specify a page range, touch the page input box and touch either or to specify the pages.

### 5) Copy/Move

Copy/Move the stored data between the Storage Memory and USB Flash Drive. From the Storage Retrieve Screen, copy/move data to the USB Flash Drive. From the USB Job List Retrieve Screen, copy/move data to the Storage Memory. For details, see [p.199](#).

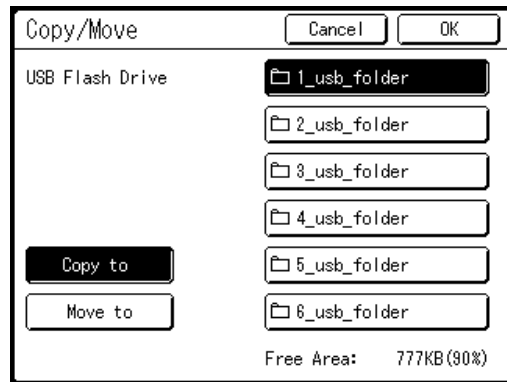

### 6) Clear

Touch **[Clear]** and a confirmation screen appears.

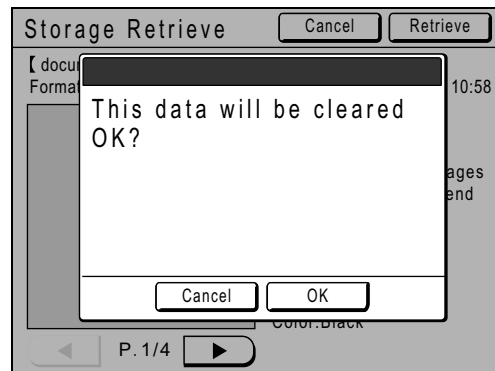

Touch **[OK]** to delete the data.

### 7) Preview

Display the Preview Screen of the enlarged thumbnail. [p.92](#)

# Overlaying Storage Data onto a Print Job

## [Overlay]

You can overlay stored data onto a hard-copy original.

For example, this function can be used to overlay a stamp over multiple originals indicating "Sample".

### Important!:

- To use this function, the optional Document Storage Card or USB Flash Drive is required.
- This function cannot be used with the following functions:
  - Ink Saving
  - Top Margin
  - Binding Margin
  - Storage Memory ("Overlay" images cannot be stored.)
  - When sending original data from the computer

## 1 Place an original.

Place the original on Glass Platen or in ADF unit (option).

See the "Basic Operations" chapter for information on placing the original.

## 2 Touch [Overlay] on the Functions Screen.

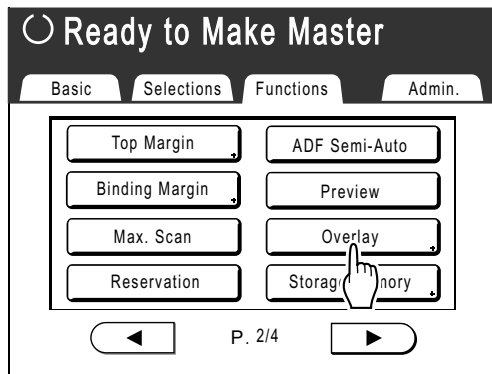

The Storage Selection Screen appears.

When overlaying data stored in the USB Flash Drive, connect the USB Flash Drive to the USB slot and touch **[USB Job List]**.

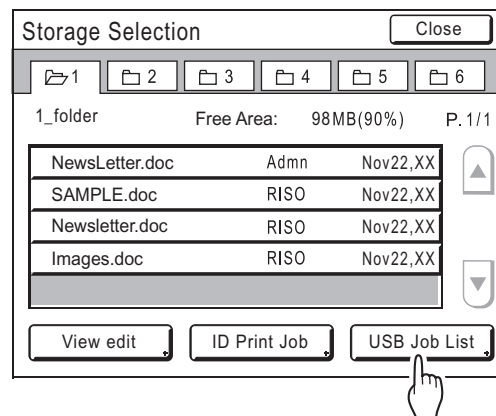

USB Job List Screen is displayed.

### Important!:

- Do not remove the USB Flash Drive until printing is finished.

### 3 Select the storage data to overlay.

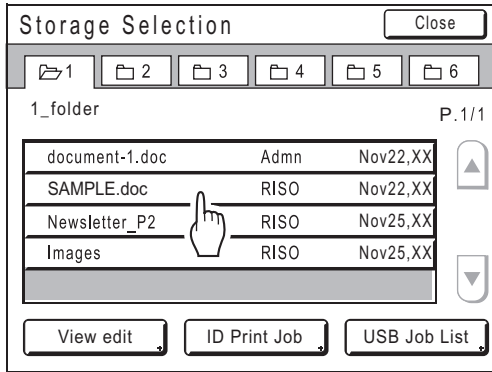

Details on how to select data, see steps 3 and 4 in “Retrieving Stored Data and Printing” p.193.

### 4 Check the stored data.

Check the thumbnail to make sure that the data is the data you want to retrieve. When there are several pages (editions), display the data by touching ◀ or ▶ button.

**Tip:**  
**Overlaying Storage Data**

The stored data overlays at the size it was saved. You cannot enlarge/reduce the size to match the original or paper size.

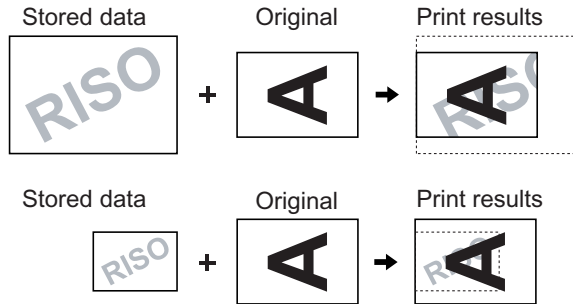

The storage data is overlaid after being centered at the top of the original. You cannot adjust the overlay position.

**Important!:**

- Only one page of data can be retrieved for Overlay.

### 5 Touch [Retrieve].

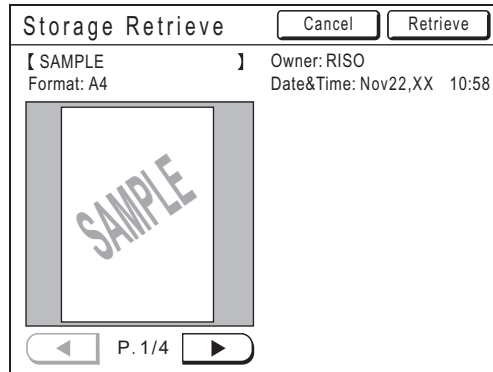

“Overlay” is set and the screen returns to the Functions Screen.

### 6 Make necessary operation to print.

For subsequent operations, see step 6 of “Printing from a Paper Document or Book.” (p.43)



# Copying/Moving Stored Data

Data can be copied or moved between the Storage Memory and the USB Flash Drive.

This is useful for performing backup or when the remaining free space of the Storage Memory or USB Flash Drive is limited.

## Note:

- It is not possible to copy/move data within the Storage Memory or USB Flash Drive.
- The original data stored in the USB Flash Drive can be organized or managed by a computer using the “RISO Utility Software” (RISO USB PRINT MANAGER) included in the provided CD-ROM. For details, see the “RISO Utility Software User’s Guide” (CD-ROM).
- The **[ID Print Job]** is maintained even if it is copied or moved

The procedure for copying/moving data from the Storage Memory to the USB Flash Drive is explained here.

## 1 Confirm that the USB Flash Drive that will store the data is connected.

If the USB Flash Drive is not connected, connect the USB Flash Drive to the USB slot.

## 2 Touch [Storage Memory] on the Functions Screen.

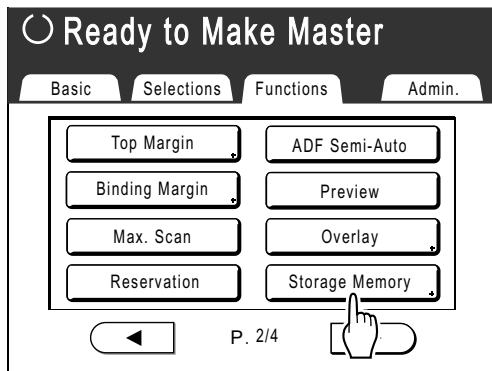

## Note:

- When copying/moving the data from the USB Flash Drive to the Storage Memory, touch **[USB Job List]**.

## 3 Touch the storage data to copy/move.

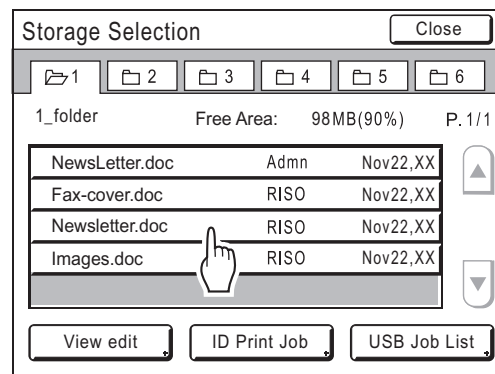

For details on how to select data, see steps 3 and 4 in “Retrieving Stored Data and Printing” p.193.

## 4 Touch [Copy/Move].

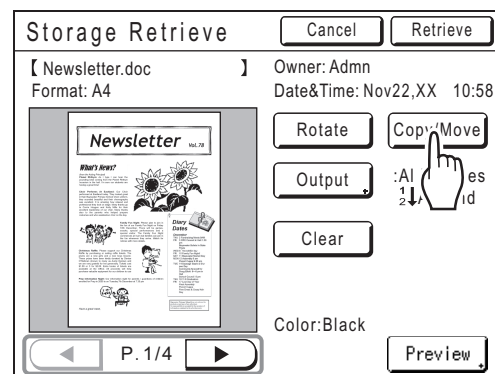

## 5 Touch [Copy to] or [Move to].

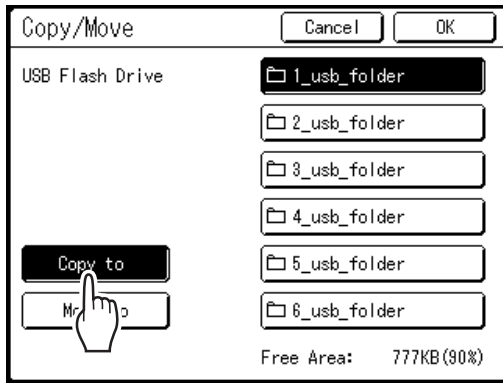

## 6 Touch the button of the destination folder that you want to copy or move the data.

## 7 Touch [OK].

Data is copied/moved and the selected destination folder is displayed.

### Important!:

- While processing the data, do not remove the USB Flash Drive. This will cause data to disappear and the USB malfunctioning.

### Note:

- When the remaining free space of the USB Flash Drive is limited, the following message is displayed. Touch **[USB Job List]** to organize the data of USB Flash Drive, or touch **[Cancel]** to cancel copying/moving.





# Replacing Consumables

## Check for Remaining Amount of Consumables

The machine checks and reports on remaining amount of Ink, master, paper, as well as the space left in the master disposal box.

### Note:

- The report may not be displayed if detection fails.
- The reported amount is for reference only and may not be perfectly accurate.
- If the Ink or master is depleted or the Master Disposal Box is full, a warning message is displayed and the machine stops.

### 1 Touch [i Info] on the Basic Screen.

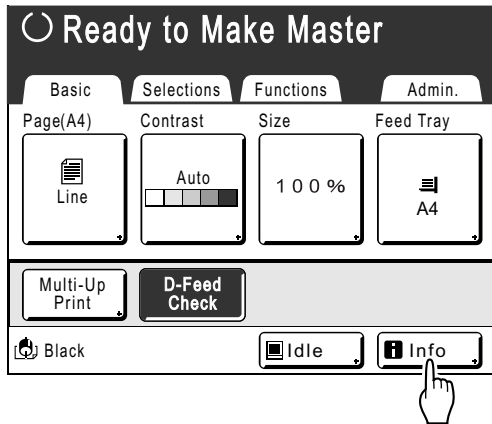

### 2 Check for remaining amount of consumables.

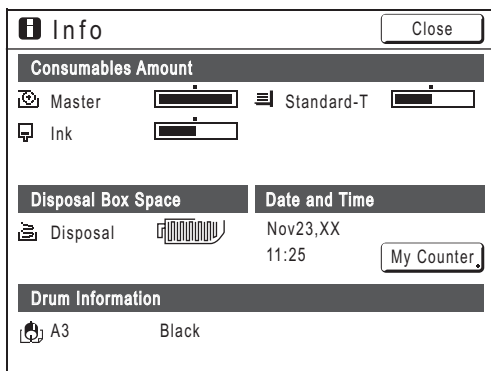

When running low, be sure to restock supply.

- Master (p.204)
- Ink (p.207)
- Master Disposal (used master) (p.209)

### Display Details

Indicator/Message	Description
	The black bar indicates the remaining amount. Ex:  approximately 10% left
(Unknown), ---, no display	Indicates that consumable data is not available, is not set, etc.

### ◆ About the “My Counter” Screen



When the “Management Level” in the User Management is set to “High/Full Management”, touch [My Counter] to display “My Counter” Screen.

On the “My Counter” Screen, you can confirm the current user’s Limit C/C, M/C and Present C/C, M/C. Limit C/C and M/C are set by the administrator. Consult your administrator for details.



My Counter		Close
U-1(G-1)		
Limit C/C	10,000	
Present C/C	6,511	
Limit M/C	10,000	
Present M/C	250	

**Tip:**



 Information Button

 icon on the  Information Button displays current status of the consumables as detected by the machine.

The  icon will change depending on the matching information detected from the consumable.

- When matching information was correctly retrieved from the consumable  (normal display)
- When matching information is not available  (gray display)

When the  icon is grayed, the remaining amount of master/Ink cannot be displayed.

When the master material or Ink runs low,  (master) or  (Ink) icon blinks on the right of the button to let you know that the item should soon be replaced.

**Note:**

- If the machine is unable to retrieve matching data from the consumable, you must enter the correct setting value.

 p.241

# Replacing the Master Roll

When the Master Roll is depleted, a message is displayed and the machine stops. Replace with a new Master Roll.

## Important!:

- For the Master Roll, it is recommended to use the products specified by RISO.
- Keep the power ON while replacing the master.

### 1 Open the Front Cover.

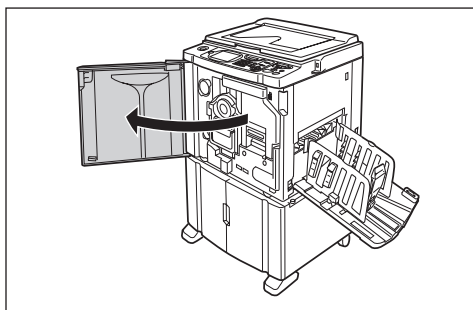

### 2 Check the indicator of the Master Making Unit Release Button is ON.

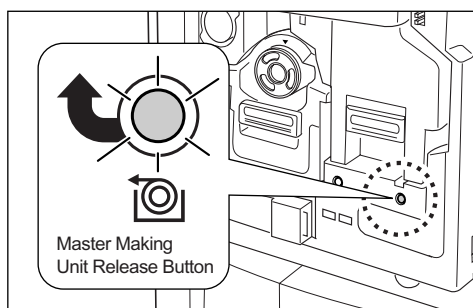

If the indicator is off, press the Master Making Unit Release Button to turn it on.

## Important!:

- When the Print Drum (Cylinder) is out, Master Making Unit cannot be pulled out. Return the Print Drum (Cylinder) into position and press the Master Making Unit Release Button.  
☞ p.211

### 3 Pull out the Master Making Unit.

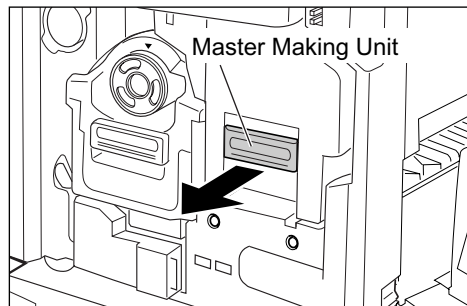

Grasp the Master Making Unit Handle and pull forward.

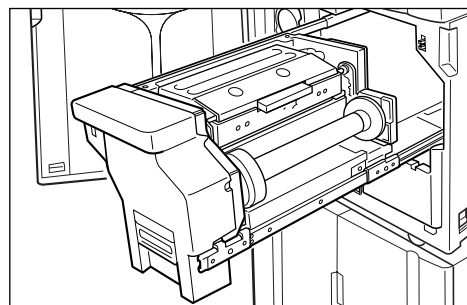

Pull out slowly until it stops.

### 4 Open the Master Making Unit Cover.

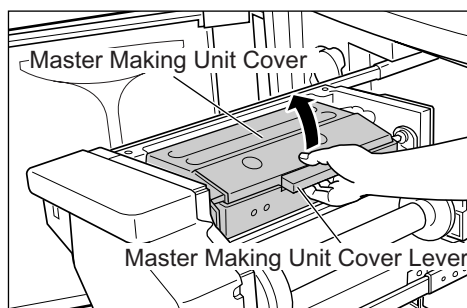

Grasp the Master Making Unit Cover Lever and open the Master Making Unit Cover.

## 5 Open the Master Roll Holder.

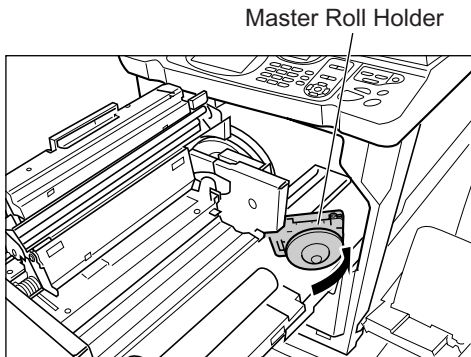

## 6 Remove the depleted Master core.

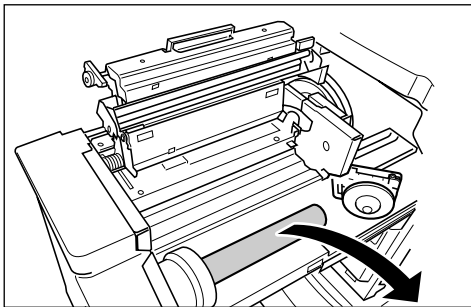

### Note:

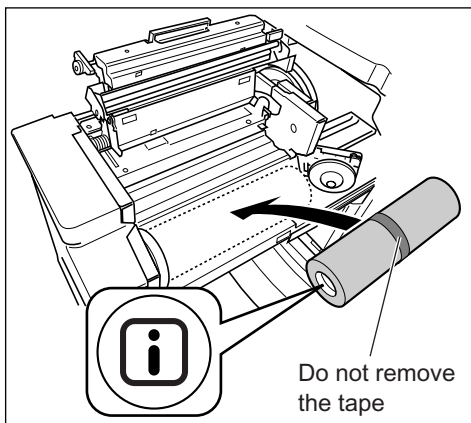

- Dispose the depleted master core according to the disposal rule of your local community. p.214

## 7 Install a new Master Roll.



Remove the plastic shrink wrap from the new Master Roll, and place in with the  mark to the left.

### Important!:

- Take care not to damage the  section when removing the shrink wrap. If the  section is bent or the perforation cut, the master will become unusable.
- Do not remove the tape yet.

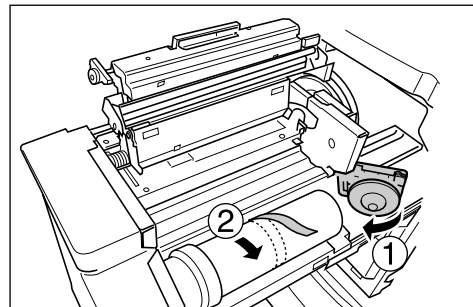

## 8 Close the Master Roll Holder.

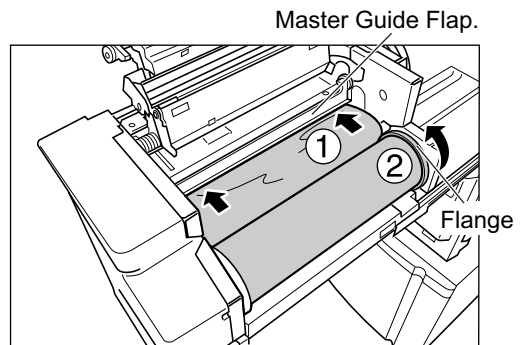

Remove the tape once the Master Roll Holder has been closed.

## 9 Insert the leading edge of the master under the Master Guide Flap.



Insert the leading edge of the master into its entrance under the Master Guide Flap and advance it as far in as it will go (  ). If the Master is loose, turn the flange at the right towards the rear and rewind (  ).

**Tip:**

**If You Cannot Insert the Master**

Insert the leading edge of the Master using the following steps.

- 1) Raise the Master Guide Flap  
Turn the dial on the edge of the Master Guide Flap towards the rear and raise the Master Guide Flap.
- 2) Pull out the master to the line indicated by the arrow.
- 3) Lower the Master Guide Flap.

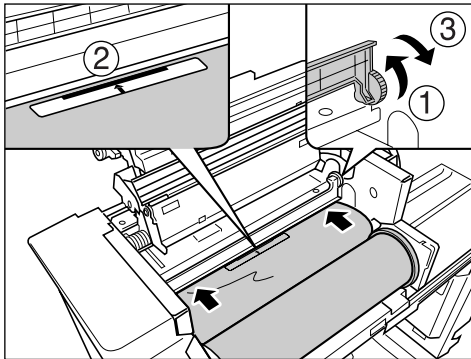

**10 Return each part to its original position.**

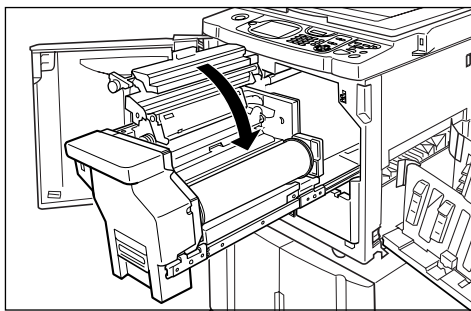

Close the Master Making Unit Cover.

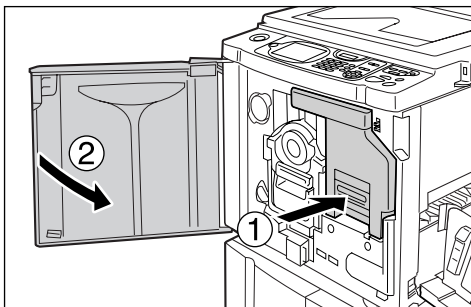

Return the Master Making Unit to its original position and close the Front Cover.



# Replacing the Ink Cartridge

When the Ink is depleted, a message is displayed and the machine stops. Replace with a new Ink Cartridge.

**⚠ Caution:**

- Ink may be left on the area around the Print Drum (Cylinder), so take care not to smudge your hands or clothes.
- Wash immediately with soap if you should get Ink on your hands, etc.

**Important!:**

- For the Ink Cartridge, it is recommended to use the products specified by RISO.
- Keep the power ON while replacing the Ink Cartridge.
- Replace with an Ink Cartridge of the same Ink color. If you want to change the Ink color, replace the Print Drum (Cylinder) itself.

☞ p.211

## 1 Open the Front Cover.

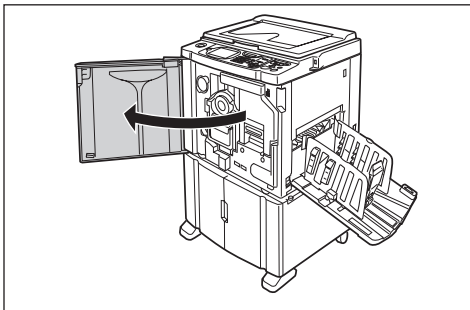

## 2 Pull the empty Ink Cartridge out of the holder.

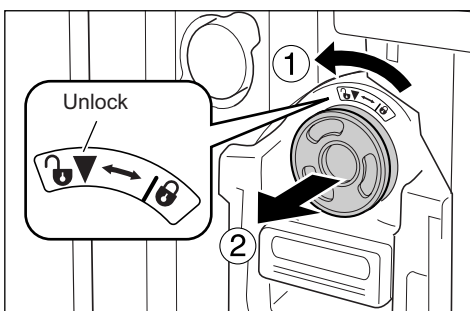

Turn the Ink Cartridge to the counter clockwise (🔒) and then pull it out.

**Important!:**

- For collection or disposal of used Ink Cartridges, refer to the following page. ☞ p.214

## 3 Remove the cap on the new Ink Cartridge.

Turn the Ink Cartridge cap to remove.

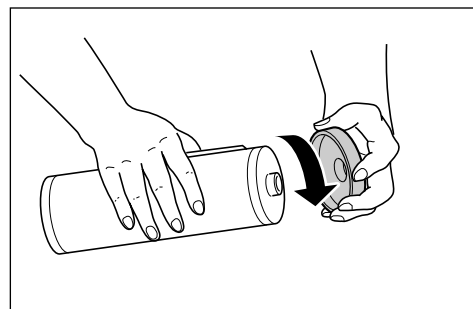

**Important!:**

- Do not touch or give impact to the outlet surface of the new Ink Cartridge. Do not peel off the label beside the Ink Cartridge opening.

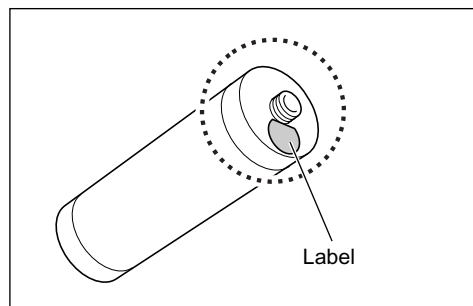

**Note:**

- You can store the Ink Cartridge cap on the upper left of the Print Drum (Cylinder).

Ink Cartridge Cap Holder

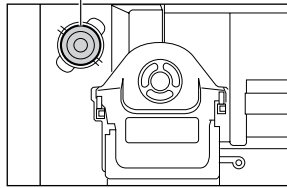

**4 Insert the new Ink Cartridge.**

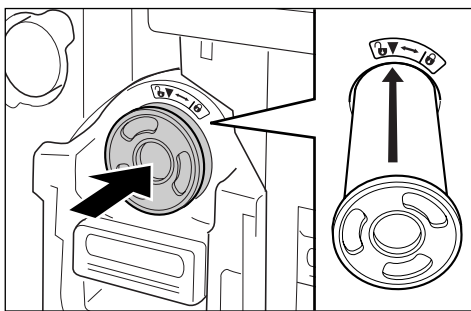

Align the arrow on the Ink Cartridge to the ▼ mark on the print drum (cylinder) unit, and insert until it stops.

**5 Lock the Ink Cartridge.**

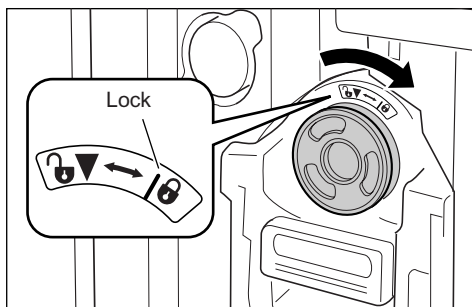

Turn the Ink Cartridge clockwise (🔒) and lock in position.

**6 Close the Front Cover.**

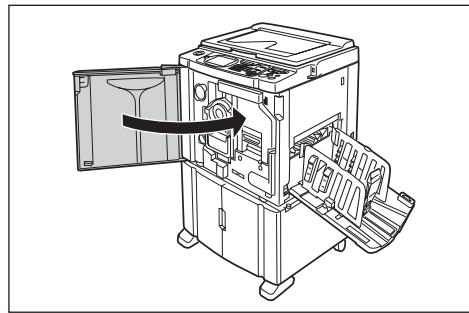

# Emptying the Master Disposal Box

Used masters are held in the Master Disposal Box. When the Master Disposal Box becomes full, a message displays and the machine stops. Discard the used masters.

**⚠ Caution:**

- Wash immediately with soap if you should get Ink on your hands, etc.

**Important!:**

- The Master Disposal Box can be padlocked to prevent the information contained in the discarded master being leaked. If the Master Disposal Box is safely protected by the padlock, be sure to contact the administrator before discarding the master.
- When “Protect” is ON, you can remove the Master Disposal Box only when the messages such as “Master Disposal Box is Full” or “Master Jammed in Disposal Unit” are displayed. [p.182](#)

## 1 Remove the Master Disposal Box.

If the Master Disposal Box lever is locked, slide the lever to the right to unlock.

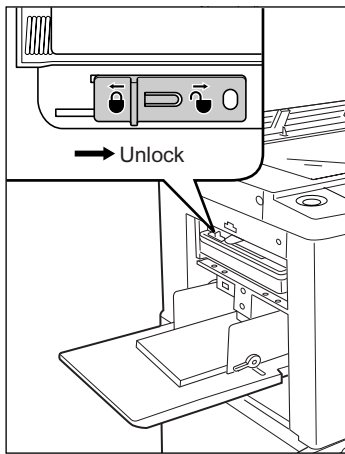

Grasp the Master Disposal Box handle and pull the box forward.

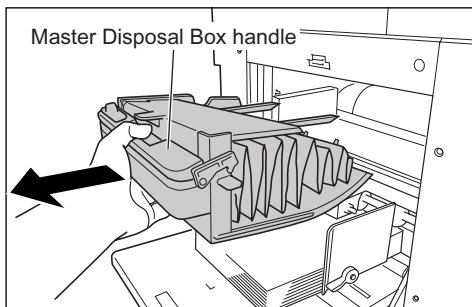

**Important!:**

- If the Master Disposal Box is padlocked, contact the administrator to undo it.

## 2 Discard the ejected masters.

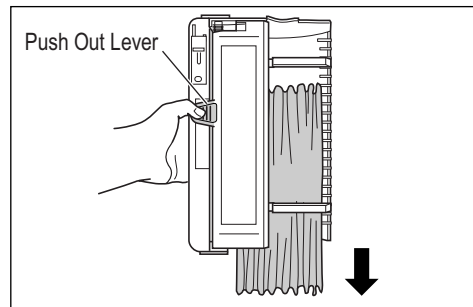

Tilt the Master Disposal Box forward and directly discard the used master into the garbage box (or bag) by grasping the Push Out Lever.

## 3 Place the Master Disposal Box into position.

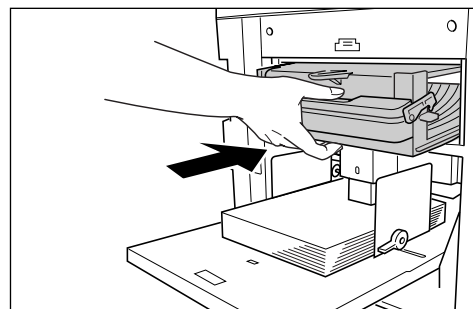

Insert the Master Disposal Box until it stops.

**Important!:**

- Dispose the ejected masters according to the disposal rule of your local community.  
☞ p.214

**Note:**

- If necessary, slide the lever to the left to lock the Master Disposal Box and also have the padlock for further safety.  
☞ p.182

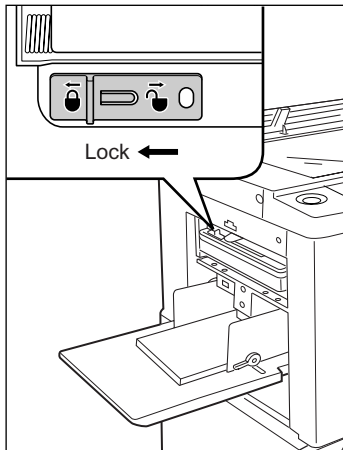

# Replacing the Print Drum (Cylinder)

When replacing with a Color Print Drum (Cylinder) to change colors, or when removing jammed paper, follow the steps to remove Print Drum (Cylinder). Be sure to use a Color Print Drum (Cylinder) specifically designed and approved for use with this machine.

## ⚠ Caution:

- Do not stand the Print Drum (Cylinder) upright. Doing so may stain the floor, etc.

## Important!:

- Use only Print Drums (Cylinders) specifically designed and approved for use with this machine.
- Keep the power ON while removing or replacing the Print Drum (Cylinder).
- Make sure to place the changed Print Drum (Cylinder) into the Print Drum (Cylinder) case and store horizontally.

## Removing the Print Drum (Cylinder)

### 1 Open the Front Cover.

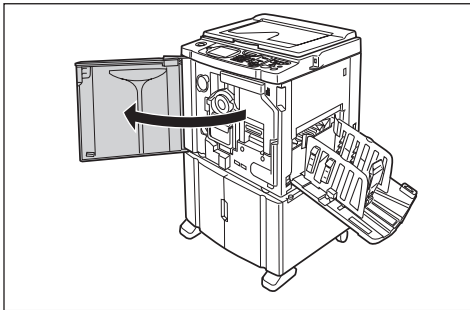

### 2 Check that the indicator of the Print Drum (Cylinder) Release Button is ON.

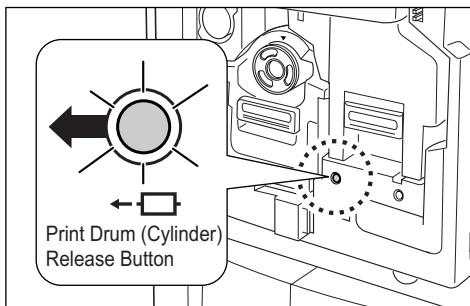

If the indicator is off, press the Print Drum (Cylinder) Release Button to turn it on.

#### Important!:

- When the Master Making Unit is out, the Print Drum (Cylinder) cannot be pulled out. Return the Master Making Unit into position and press the Print Drum (Cylinder) Release button.

☞ p.204

### 3 Pull out the Print Drum (Cylinder).

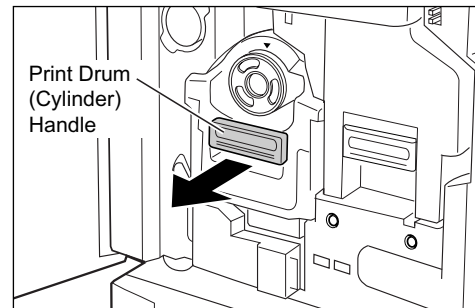

Grasp the Print Drum (Cylinder) Handle and slowly pull until the Print Drum (Cylinder) is completely extended.

### 4 Remove the Print Drum (Cylinder).

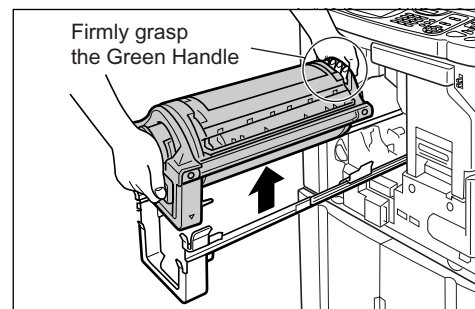

Use both hands to lift the Print Drum (Cylinder) straight up to remove from the rail. Proceed with replacing the Print Drum (Cylinder), removing the paper jam, etc..

**⚠ Caution:**

- Do not touch the connector on the Print Drum (Cylinder).  
Neglecting this may result in malfunction of the Print Drum (Cylinder) because of static electricity or other factors.

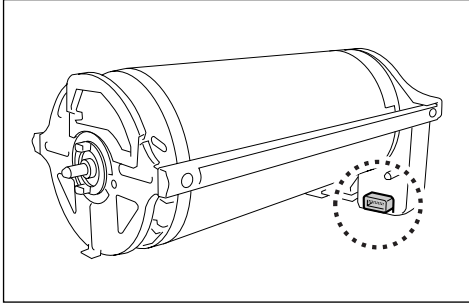

## Installing the Print Drum (Cylinder)

### 1 Place the Print Drum (Cylinder) on the Rail.

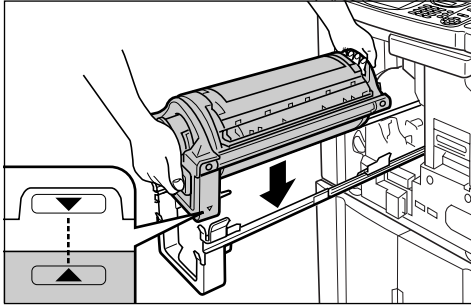

Align the ▼ mark on the Print Drum (Cylinder) with the ▲ mark on the guide, and place the Print Drum (Cylinder) horizontally onto the guide.

#### Note:

- If the Print Drum (Cylinder) was manually rotated, be sure to turn it back so that ► and ◀ marks align, after it is placed on the guide.

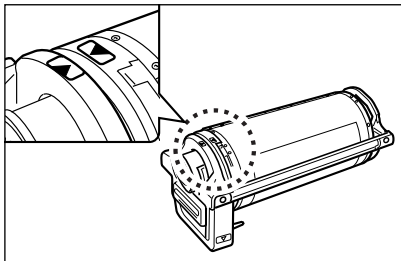

### 2 Return the Print Drum (Cylinder) to its original position.

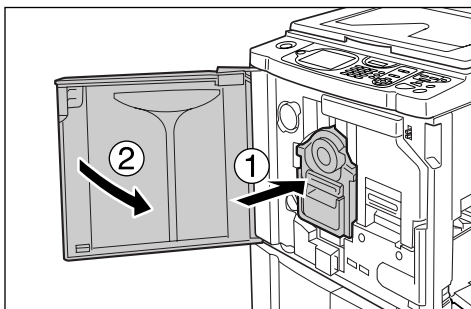

Push the Print Drum (Cylinder) in as far as it will go, and then close the Front Cover.

#### Important!:

- Do not grasp the Print Drum (Cylinder) Handle when pushing in the Print Drum (Cylinder).

#### Tip:

#### Changing the Print Drum (Cylinder) Type

When you install a different type of Print Drum (Cylinder), the Confirm Print Drum (Cylinder) Type screen appears.

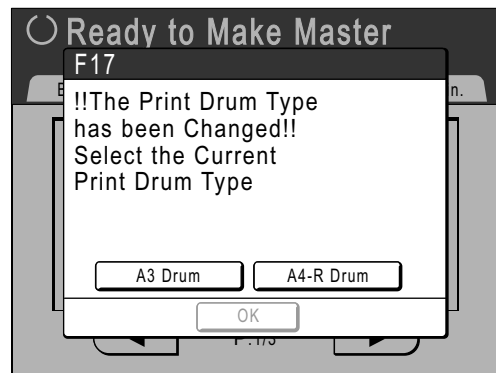

- 1) Select the type corresponding to the installed Print Drum (Cylinder).
- 2) Touch [OK].  
The Print Drum (Cylinder) type is confirmed and printing is enabled.

#### Important!:

- You will not be able to print until the Print Drum (Cylinder) type is confirmed.
- If you install a non-approved Color Print Drum (Cylinder), the message "Wrong-Type Print Drum Installed Replace with Correct Type" is displayed. Install a Color Print Drum (Cylinder) specifically approved for use with this machine.

# Disposal of Depleted Consumables

Dispose of depleted Ink Cartridges, Master cores, ejected masters according to the regulations in your local community.

If required, separate the specific components using the following procedures to dispose them properly.

## ◆ Ink Cartridge

Remove the label (metal included) at the arrow from the outlet surface of the Ink Cartridge, and then dispose them separately.

Because Ink may have adhered to the outlet surface of the Ink Cartridge, be careful not to smudge your clothes.

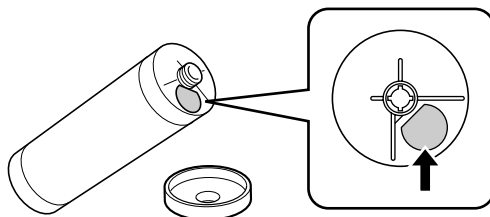

Parts	Materials
Ink Cartridge material	plastic (polypropylene/polyethylene)
Label material	plastic (metal included)
Ink	Soy oil, petroleum hydrocarbons, water, pigments

## ◆ Master core

A metallic component has been attached to the bottom of the end section having the  mark stamped.

Because the component section has been perforated for cutout convenience, tear along the perforation for proper disposal.

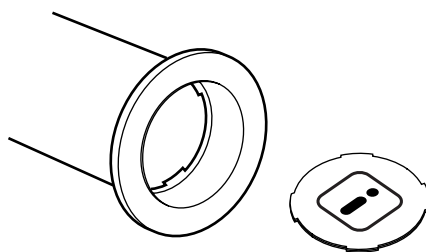

Parts	Materials
Core material	Paper
Master material	plastic, Japanese paper
Material of the cutout component	plastic (metal included) and paper



**◆ Ejected Master**

Parts	Materials
Master material	plastic, Japanese paper
Ink material	Soy oil, petroleum hydrocarbons, water, pigments

**Note:**

- It is made of carbon and hydrogen compounds. If fully combusted, it will turn into water and carbon dioxide.



# Maintenance

## Cleaning

The print quality may suffer if parts such as Thermal Print Head of the Master Making Unit, Scanner Glass of the optional ADF unit, White Sheet, etc. are contaminated with dust, dirt, Ink, white-out, etc..

Follow the steps below for periodic cleaning.

### **⚠ WARNING:**

- Before cleaning any part of the machine, turn off the power.
- Do not remove any fixed covers.
- Contact your service representative immediately if you suspect any dangerous situations or have questions or problems with the machine.
- Contact your service representative before moving the machine.
- Do not allow unauthorized persons to make adjustments or repairs.

### **⚠ Caution:**

- The machine has precision moving parts inside. Do not handle the machine in any other way than described in this manual.
- Be careful of the edge of metal parts, otherwise it may cause an injury.
- Do not make any modifications to the machine or remove any parts.
- Neither Riso nor its dealer (or authorized service representative) is responsible for maintenance service performed by non-Riso-authorized personnel.

---

## Thermal Print Head

---

Clean the Thermal Print Head each time you replace the Master Roll.

Open the Master Making Unit Cover, and gently wipe the Thermal Print Head in the back of the unit several times with a soft cloth or tissue.

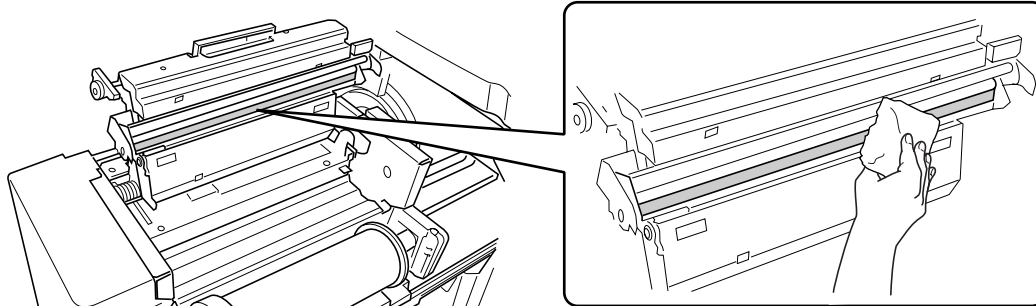

### Important!:

- Since the Thermal Print Head is very delicate, avoid shocks or scratches with a hard object.
- Since Thermal Print Head is susceptible to (damage by) static electricity, please be sure to remove the static electricity charged in the body before cleaning.

---

## Glass Platen and Platen Cover Pad

---

If the Glass Platen and/or Platen Cover Pad is stained, gently wipe them with a soft cloth or tissue.

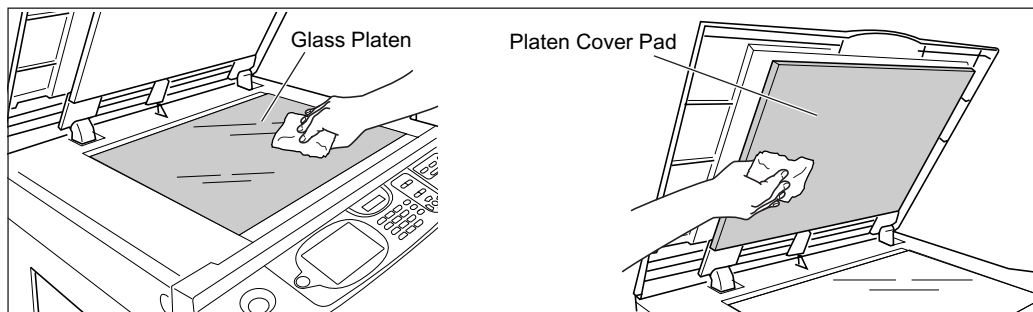

### Important!:

- Since the Glass Platen is very delicate, avoid shocks or scratches with a hard object.

## Scanner Glass and White Sheet of ADF unit (Option)

---

Gently wipe the Scanner Glass, and the White Sheet several times with a soft cloth or tissue.

**Important!:**

- Since the Glass Platen is very delicate, avoid shocks or scratches with a hard object.

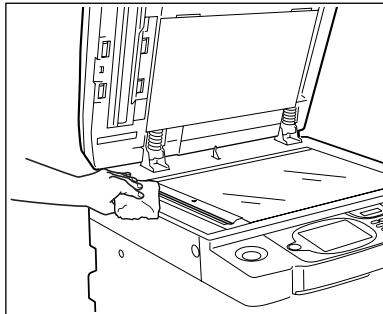

◆ **For the Auto Document Feeder AF-VI:II**

Clean while rotating the White Roller.

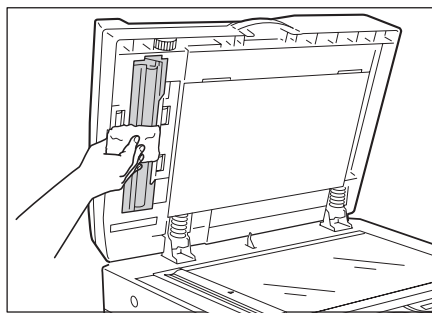

◆ **For the Auto Document Feeder DX-1**

The white Sheet does not rotate.

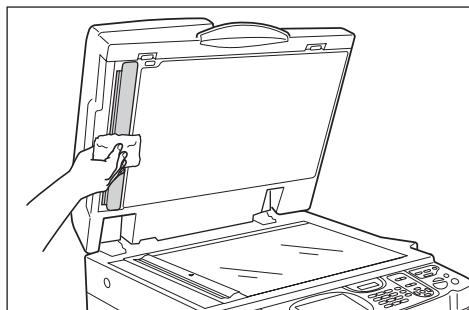

## Pressure Roller

If the Pressure Roller, which presses print paper against the Print Drum (Cylinder), is stained, smudged strips may appear on the back of copies.

If this happens, gently wipe the Pressure Roller with a soft cloth dampened with alcohol.

To remove the Print Drum (Cylinder), see [p.211](#).

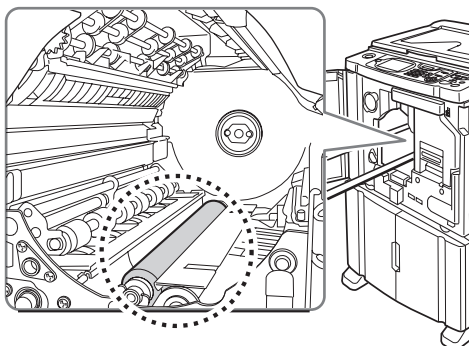

### **⚠ Caution:**

- Be sure to turn OFF power to the machine when cleaning the Pressure Roller.
- When you insert a hand inside the machine, be careful not to touch the paper separation hook or master removal hook. The tips of the paper separation hook and master removal hook are sharp, so they may cause injury.
- Ink may be left on the area near the Print Drum (Cylinder), so take care not to smudge your hands or clothes. Wash immediately with soap if you should get Ink on your hands, etc.

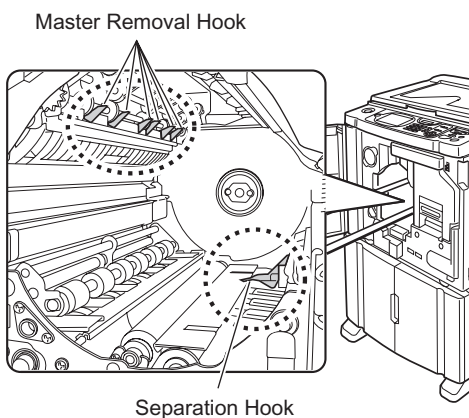

## The Exterior

---

Use a soft cloth to gently wipe down the entire printer on a regular basis in order to prevent the exterior from getting dirty.

If using a cleaning agent, use one recommended by your authorized service representative.

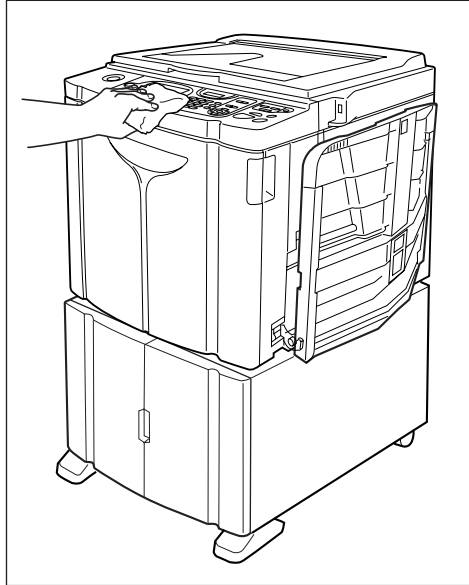

### **Important!:**

- Because the machine exterior is plastic, never use alcohol or solvent when cleaning.
- The Display may be cleaned by gently wiping with a dry cloth. Dampen a cloth with a small amount of cleaner and gently wipe to remove any Ink.  
Do not spray or pour cleaner solution directly onto the display. Doing so can cause damage.





# Troubleshooting

## When a Message Displays

Refer to the following information to determine the cause and take appropriate actions when the machine stops operating and a message is displayed.

**⚠ Caution:**

**When you insert a hand inside the machine to remove paper, etc., be careful not to touch protruding objects or the edges of the plates. This may cause injury.**

### Error Message Layout

A message and a troubleshooting illustration will be displayed in accordance with the message type to show how to resolve the problem.

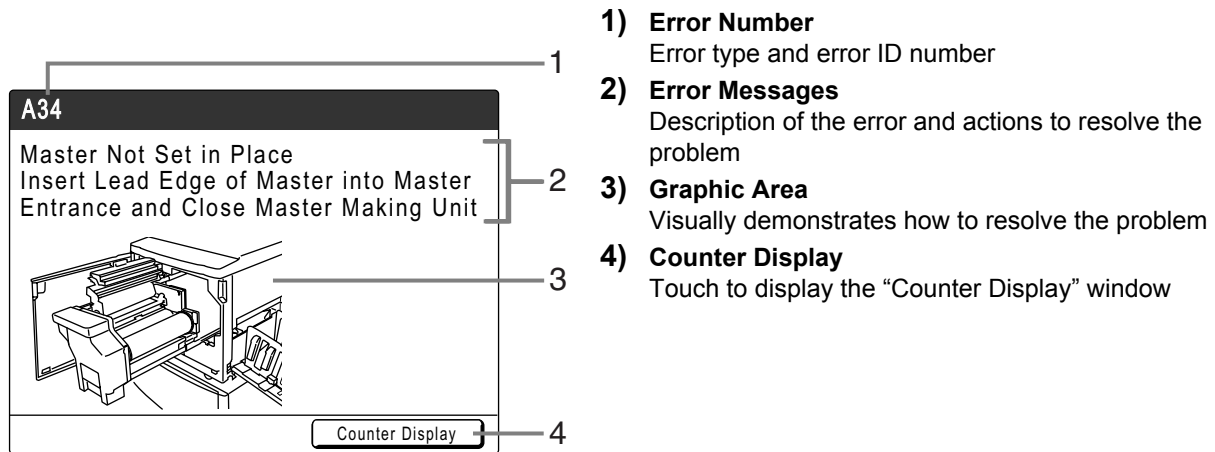



- 1) Error Number**  
Error type and error ID number
- 2) Error Messages**  
Description of the error and actions to resolve the problem
- 3) Graphic Area**  
Visually demonstrates how to resolve the problem
- 4) Counter Display**  
Touch to display the “Counter Display” window

Error Number	Error Types	Description	Reference page
T00-000	Service Call Error	Errors that require repair or inspection by a authorized service representative. To resolve a Service Call Error, contact your dealer (or authorized service representative) with the error number.	☞ p.223
A00-000	Jam Error	Displays when the master is jammed, etc..	☞ p.223
B00-000	Optional Device Error	Displays when an error occurs on the optional device.	☞ p.224
C00-000	Consumable Error	Displays when a consumable such as Ink or master roll is depleted.	☞ p.225
D00-000	Installation Error	Displays when a part or unit is not properly installed.	☞ p.226







Error Number	Error Types	Description	Reference page
J00-000	Paper Jam Error	Displays when an original document or printing paper is jammed.	p.228

**T00-000:Service Call Error (in alphabetical order)**

Message	Possible Cause	Action
!!Battery Replacement!! Call Service	The battery is low or depleted.	Contact your dealer (or authorized service representative) and have the battery replaced. Press the  key or the  key to clear the error message display.
!!System Error!! Press Reset Key If Recovery has Failed, Call Service	A system error has occurred.	Press the  key. If the problem persists, contact your dealer (or authorized service representative).
!!System Error!! Turn Main Power SW OFF Then ON If Recovery has Failed, Call Service		Shut off power, then restart. If the problem persists, contact your dealer (or authorized service representative).

**A00-000:Jam Errors (in alphabetical order)**

Message	Possible Cause	Action
Master Disposal Error Pull Out Print Cylinder and Discard Master	The master was not properly discarded.	<ol style="list-style-type: none"> <li>1) Pull out the Print Drum (Cylinder) and remove the master from the Print Drum (Cylinder). p.211</li> <li>2) Return the Print Drum (Cylinder) in place.</li> <li>3) Press the  key.</li> </ol>
Master Jammed in Disposal Unit Pull Out Master Disposal Box and Remove Jammed Master	The master is jammed in the Master Disposal Unit.	Pull out the Master Disposal Box and remove the jammed master. If the masters are difficult to remove, pull out the Print Drum (Cylinder) and then remove. p.209 p.211 If the error persists, contact your dealer (or authorized service representative).
Master Loading Error Pull Out Print Cylinder and Discard Master	The master is not properly attached to the Print Drum (Cylinder).	<ol style="list-style-type: none"> <li>1) Pull out the Print Drum (Cylinder) and remove the master from the Print Drum (Cylinder). p.211</li> <li>2) Return the Print Drum (Cylinder) in place.</li> <li>3) Press the  key.</li> </ol>

Message	Possible Cause	Action
Master Mis-Feed Pull Out Master Making Unit and Rewind Master Roll, then Reset Master in Place	The master is improperly installed.	Pull out the Master Making Unit, rewind the master and reinstall. ☞ p.204
Master Not Set in Place Insert Lead Edge of Master into Master Entrance and Close Master Making Unit	The master is improperly installed or is missing.	Pull out the Master Making Unit and reinstall the master. ☞ p.204 <b>Important!:</b> • If the leading edge of the master is wrinkled or torn, cut the edge straight and reinstall.
Master Remains on Print Drum Pull Out Print Drum and Remove Master	An unnecessary master remains on the Print Drum (Cylinder).	<b>1)</b> Pull out the Print Drum (Cylinder) and remove the master from the Print Drum (Cylinder). ☞ p.211 <b>2)</b> Return the Print Drum (Cylinder) in place. <b>3)</b> Press the  key.
Paper Jam Remove Paper in Indicated Areas and Press [OK] Button	Paper jammed in indicated area.	<b>1)</b> Remove the jammed paper. <b>2)</b> Press the  key or touch [OK].
Safety SW on Paper Feed Tray is Activated Reset paper on Paper Feed Tray	The safety switch for the Paper Feed Tray has been activated.	Check underneath the Paper Feed Tray and on top of the printing paper for any obstructions. Remove if any exists.
System Error in Master Making Unit Take Out Master and then Close Master Making Unit Cover	The cutter mechanism for the master malfunctioned.	Pull out the Master Making Unit and remove the master. ☞ p.204 Closing the Master Making Unit Cover will reset the error. Setup the master again.

### B00-000:Optional Device Error (in alphabetical order)

Message	Possible Cause	Action
Can not identify	<ul style="list-style-type: none"> <li>• Something other than a USB Flash Drive is connected to the USB slot.</li> <li>• A defective USB Flash Drive is connected to the USB slot.</li> <li>• A USB Flash Drive not recognized by this machine is connected to the USB slot.</li> </ul>	Connect a USB Flash Drive for this machine. ☞ p.46
Can not identify (USB hub)	A USB hub is connected to the USB slot.	Connect the correct corresponding USB Flash Drive. ☞ p.46
Insert Card in Key/Card Counter	No card in the Key Card Counter (option).	Insert Card in the Key Card Counter.



Message	Possible Cause	Action
!! Job Separator is OFF !! Turn On Power Switch of it	The Job Separator (option) is turned OFF.	Turn on the Job Separator.
No IP Address Assigned to This Printer Contact Your Network Administrator	IP address for the machine is not properly set.	Contact your system administrator and set the machine IP address correctly. ☞ p.169
No Paper Tape in Job Separator Replace Tape Roll	No tape in the Job Separator (option).	Load new tape into the Job Separator.
Paper Tape Jam in Job Separator Remove Paper Tape	Tape jam occurred in the Job Separator (option).	Check the Job Separator and remove jammed tape.
!!System Error!! Turn Main Power SW OFF Then ON If Recovery has Failed, Call Service	A system error has occurred.	Shut off power, then restart. If recovery has failed, contact your dealer (or authorized service representative).

**C00-000:Consumable Errors (in alphabetical order)**

Message	Possible Cause	Action
Add Paper	No printing paper in the Paper Feed Tray.	Load paper into the Paper Feed Tray. ☞ p.34
Master Disposal Box is Full Empty Master Disposal Box	The Master Disposal Box is full.	Empty the Master Disposal Box. ☞ p.209
No Ink Replace Ink Cartridge	The Ink is depleted.	Replace and install a new Ink Cartridge. Use the Ink Cartridge specifically designed and approved for use with this machine. ☞ p.207  <b>Important!:</b> • If the error persists after replacing the Ink Cartridge, check for proper installation of the Ink Cartridge.
No Master Replace Master Roll	The Master Roll is depleted.	Install a new Master Roll. Use Master Roll specifically designed and approved for use with this machine. ☞ p.204

**D00-000:Installation Error (in alphabetical order)**

Message	Possible Cause	Action
Close Front Cover	The Front Cover is open or improperly closed.	Check for the magnet underneath the Front Cover and firmly close.
Close Master Making Unit Cover	The Master Making Unit Cover is open or is improperly installed.	Pull out the Master Making Unit, check and firmly close its cover.
Close the ADF Cover	Optional Auto Document Feeder DX-1 cover is open or incorrectly set.	Check the ADF Cover and close it firmly.
Install Ink Cartridge	The Ink Cartridge is improperly installed or is missing.	Properly install the Ink Cartridge. ☞ p.207
Master Making Unit has been Unlocked	The Master Making Unit is ready to be pulled out.	Pull out the Master Making Unit.
Print Drum has been Unlocked	The Print Drum (Cylinder) is ready to be pulled out.	Pull out the Print Drum (Cylinder).
Print Drum Not Set in Place Press Drum Release Button and Pull Out Print Drum after the Button Lights	The Print Drum (Cylinder) is locked but not pushed in properly.	Press the Print Drum (Cylinder) Release Button. Remove the Print Drum (Cylinder) after the button is lit and reinstall.
Rear Cover of Main Body is Off Call Service	The machine rear cover is removed.	Contact your dealer (or authorized service representative).
Set Master Disposal Box in Place	The Master Disposal Box is improperly set or is missing.	Properly set the Master Disposal Box. ☞ p.209
Set Master in Place	No master is installed.	Install a Master Roll. ☞ p.204
Set Master Making Unit in Place	The Master Making Unit is missing or is improperly installed.	Properly install the Master Making Unit. ☞ p.204
Set Print Drum (Cylinder) in Place	The Print Drum (Cylinder) is improperly set or is missing.	Properly install the Print Drum (Cylinder). ☞ p.211
Wrong-type Ink Cartridge Installed or Cannot Read Ink Info Replace Ink Cartridge or Contact dealer (or authorized service representative)/Riso office	Incorrect type or color of the Ink Cartridge is installed.	Properly install a correct Ink Cartridge. ☞ p.207  <b>Important!:</b> • Use the Ink Cartridge specifically designed and approved for use with this machine. Failure to do so may cause problems or damage to the machine.
	The label on the Ink Cartridge outlet surface has come off or surface is with dirt.	The label on the Ink Cartridge outlet surface contains information needed for printing. If the machine cannot read the information, it does not operate. Set an Ink Cartridge that is specific to the machine and that is with label attachment and free from dirt.

Message	Possible Cause	Action
<p>Wrong-type Master Installed or Cannot Read Master Info Replace Master Roll or Contact dealer (or authorized service representative)/Riso office</p>	<p>Incorrect type of master is installed.</p>	<p>Set a correct Master Roll. ☞p.204</p> <p><b>Important!:</b></p> <ul style="list-style-type: none"> <li>• Use a Master Roll specifically designed and approved for use with this machine. Failure to do so may cause problems or damage to the machine.</li> </ul>
	<p>The  section on the master core is missing, or it has worn off, or it has been tilted.</p>	<p>The  section on the master core contains information needed for making masters. If the machine cannot read the information, it does not operate. Set a dedicated Master Roll that has the  mark and is free from wear and tilt.</p>
<p>Wrong-Type Print Drum (Cylinder) Installed Replace with Correct Type</p>	<p>Incorrect Print Drum (Cylinder) is installed.</p>	<p>Install a correct Print Drum (Cylinder). ☞p.211</p> <p><b>Important!:</b></p> <ul style="list-style-type: none"> <li>• Use a Print Drum (Cylinder) specifically designed and approved for use with this machine. Failure to do so may cause problems or damage to the machine.</li> </ul>

## J00-000:Paper Jam Error

Displays when the original document or printing paper is jammed inside the machine, the ADF unit (option).

The location of the paper jam is indicated by the flashing icon ( ① - ④ ) in the illustration. Refer to the table below ( ① - ④ ) and resolve the issue as indicated.

**Note:**

- Use appropriate printing paper to prevent paper jams. Also select appropriate original document suitable for the ADF unit.
  - ☞ p.16
  - ☞ p.18

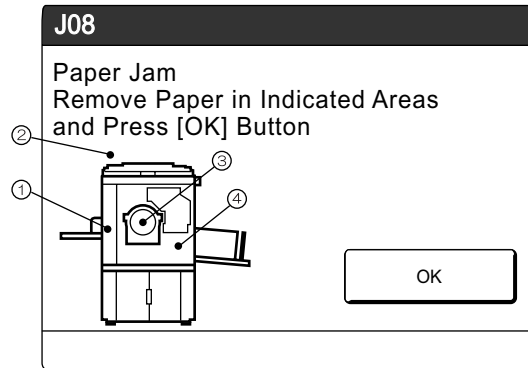

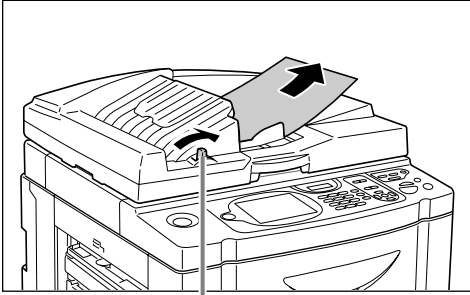
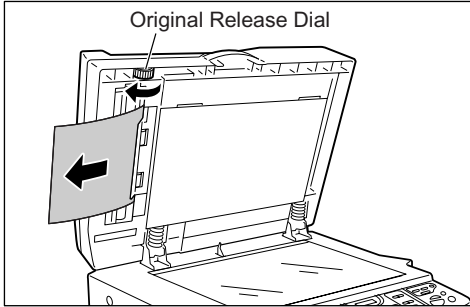
Area Indicated/ Blinking	Possible Cause	Action
①	Paper is jammed in the Paper Feed area.	<ol style="list-style-type: none"> <li>1) Check the paper feed side and remove the jammed paper.</li> <li>2) Touch [OK].</li> </ol> <p><b>Note:</b></p> <ul style="list-style-type: none"> <li>• When using special paper, adjust the Paper Feed Pressure Adjustment Lever according to the paper characteristics. ☞ p.34</li> </ul>
②	The original is jammed in the optional ADF unit.	<p>◆ <b>For Auto Document Feeder AF-VI:II</b></p> <p><b>Removing in the document insertion direction</b> Pull the ADF Original Release Lever to the right, and pull out the original.</p>  <p style="text-align: center;">ADF Original Release Lever</p> <p><b>Removing in the document ejection direction</b> Raise Platen Cover, turn the ADF Original Release Dial and remove the original.</p>  <p style="text-align: center;">Original Release Dial</p>

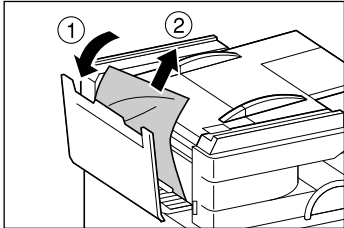
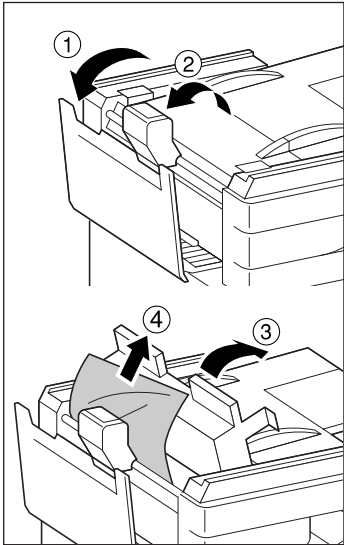
Area Indicated/ Blinking	Possible Cause	Action
<p>②</p>	<p>The original is jammed in the optional ADF unit.</p>	<p>◆ <b>For Auto Document Feeder DX-1</b></p> <p><b>Important!:</b></p> <ul style="list-style-type: none"> <li>• Take care not to touch the roller inside the unit. It may cause smudges on the original or a paper jam.</li> </ul> <p><b>Removing originals jammed in the document feeder</b>            Open the ADF Cover ( ① ), and pull out the original ( ② ).</p>  <p><b>Removing originals jammed in the document carrier</b>            Open the ADF Cover ( ① ), and raise the feed roller as shown ( ② ).            Open the inside cover ( ③ ), and pull out the original ( ④ ).</p> 

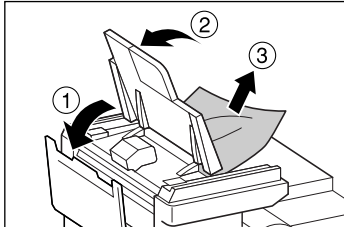
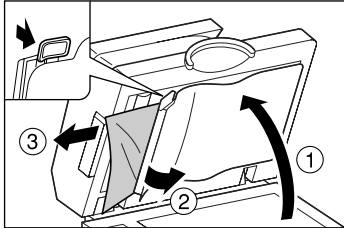
Area Indicated/ Blinking	Possible Cause	Action
②	The original is jammed in the optional ADF unit.	<p>◆ <b>For Auto Document Feeder DX-1</b></p> <p><b>Removing originals jammed in the duplex document carrier</b>                      Open the ADF Cover ( ① ), and raise the document tray as shown ( ② ).                      Pull out the original ( ③ ).</p>  <p><b>Removing originals jammed in the original receiving unit</b>                      Lift the Platen Cover Pad up ( ① ), pull the release lever toward you ( ② ), and pull out the original ( ③ ).</p> 

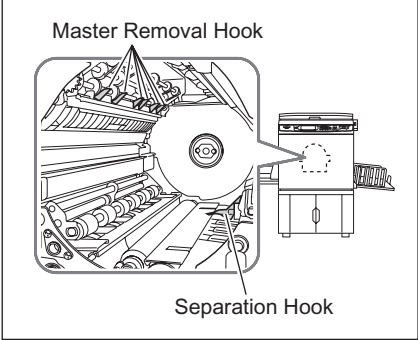

Area Indicated/ Blinking	Possible Cause	Action
③	Paper is jammed in the Print Drum (Cylinder) area.	<ol style="list-style-type: none"> <li>1) Pull out the Print Drum (Cylinder). ☞ p.211</li> <li>2) Remove the jammed paper.</li> <li>3) Return the Print Drum (Cylinder) in place.</li> <li>4) Touch <b>[OK]</b>.</li> </ol> <p><b>⚠ Caution:</b>  <b>The tips of the paper separation hook and master removal hook are sharp. When you insert a hand inside the machine to remove paper, be careful not to touch the paper separation hook or master removal hook. This may cause injury.</b></p> <div style="text-align: center;">  </div>
④	Paper did not eject correctly.	<ol style="list-style-type: none"> <li>1) Check for any jammed paper on the paper exit area.</li> <li>2) Touch <b>[OK]</b>.</li> </ol> <p><b>Note:</b></p> <ul style="list-style-type: none"> <li>• When using special paper, adjust the Paper Arranger on the Receiving Tray Paper Guides according to the paper characteristics. ☞ p.34</li> </ul>

# Pop-Up Message Layout

Pop-Up Messages communicates various operational statuses.



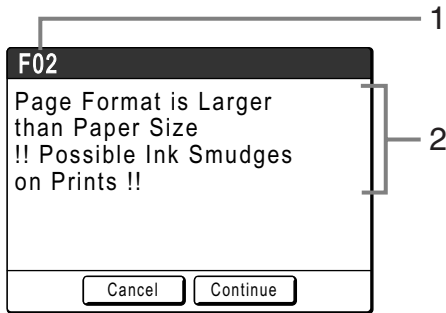

You can continue operation over some of them, but depending upon the context, others will require your action before operations can be resumed.











- 1) **Error Number**  
A reference letter (E/F) and an ID number.
- 2) **Pop-Up Messages**  
Content of the message.















Error Number	Error Types	Description	Reference page
E00-000	Maintenance Call	Pops up when battery replacement or a routine inspection by a service personnel is required.	p.232
F00-000	Warning Messages	Pops up when printing job cannot proceed due to a conflict between a Control Panel setting and the status of the machine.	p.233







## E00-000:Maintenance Call (in alphabetical order)













Message	Symptom/Action	How to Clear a Pop-Up Message
!!Low Battery!! Call Service	(Symptom) Low battery.  (Action) Contact your dealer (or authorized service representative) and have the battery replaced.	Touch <b>[Close]</b> . (Alternatively, press the  key or the  key to clear.)
!!Maintenance!! Call Service	(Symptom) Notifies user about the need for a periodic maintenance.  (Action) Contact your dealer (or authorized service representative).	Touch <b>[Close]</b> . (Alternatively, press the  key or the  key to clear.)

















**F00-000:Warning Messages (in alphabetical order)**













Message	Symptom/Action	How to Clear a Pop-Up Message
Auto Page Size Selection is Not Available for Irregular-Size Original Select Format Size to Store and then Restart	<p>(Cause 1) Attempting to scan an irregular-size original using “Auto” in scanning mode.</p> <p>(Action) Select the original size manually.</p> <p>(Cause 2) A normal-size original has been set in the wrong position.</p> <p>(Action) Lift the Platen Cover Pad up and set the original correctly.</p>	<ul style="list-style-type: none"> <li>• <b>To specify the format for saving</b> Touch <b>[Saving Format]</b>.</li> <li>• <b>To cancel scanning</b> Touch <b>[Cancel]</b>. (Alternatively, press the  key or the  key to clear.)</li> </ul>
Auto Paper Size Selection is Not Available for Irregular-Size Original Select Paper Size Manually and then Press START Key	<p>(Cause 1) Attempting to copy an irregular-size original using “Auto”.</p> <p>(Action) Select a Feed Tray with the correct size paper.</p> <p>(Cause 2) A normal-size original has been set in the wrong position.</p> <p>(Action) Lift the Platen Cover Pad up and set the original correctly.</p>	<ul style="list-style-type: none"> <li>• <b>To select the Feed Tray</b> Touch the button of the Feed Tray you wish to use.</li> <li>• <b>To stop the print job:</b> Touch <b>[Cancel]</b>. (Alternatively, press the  key or the  key to clear.)</li> </ul>
!! Book Shadow Editor is Not Available with ADF !! Place Original on Glass Platen	<p>(Symptom) Auto Document Feeder is disabled while Book Shadow function is active.</p> <p>(Action) Place the original on the Glass Platen. ☞ p.84</p>	<p>Touch <b>[Close]</b>. (Alternatively, press the  key or the  key to clear.)</p>
Can not use this setting with current paper Set the appropriate standard sized paper on the feeding tray	<p>(Symptom) Binding margin function cannot be used when custom-sized paper is in the Paper Feed Tray.</p> <p>(Action) Load standard size paper in the Paper Feed Tray.</p>	<p>Touch <b>[Close]</b>. (Alternatively, press the  key or the  key to clear.)</p>

Message	Symptom/Action	How to Clear a Pop-Up Message
Check Paper Receiving Tray	<p>(Symptom) Receiving Tray Paper Guides of the Auto-control Stacking Tray are incorrectly set.</p> <p>(Action) Check the Receiving Tray Paper Guides of the Auto-control Stacking Tray.</p>	<ul style="list-style-type: none"> <li>• <b>When resuming the print job:</b> Touch <b>[Continue]</b>. (Alternatively, press the  key to print.)</li> <li>• <b>When stopping the print job:</b> Touch <b>[Cancel]</b>. (Alternatively, press the  key or the  key to clear.)</li> </ul>
Check Stock of Required Ink and Please Order If Needed	<p>(Symptom) The remaining quantity of Ink Cartridge or Master Roll has become less than specified on “Stock Management”.</p>	<p>Touch <b>[Close]</b>. (Alternatively, press the  key or the  key to clear.)</p>
Check Stock of Required Master and Please Order If Needed	<p>p.171</p> <p>(Action) Order Ink Cartridges or Master Rolls if necessary.</p>	<p>Touch <b>[Close]</b>. (Alternatively, press the  key or the  key to clear.)</p>
Check the Original Size The Original Size is larger than Max. Printing Area	<p>(Symptom) As the original size is larger than the maximum printing area, extra areas may not be printed.</p> <p>(Action) Modify the reproduction size.</p>	<ul style="list-style-type: none"> <li>• <b>To change the “Size” setting:</b> Touch <b>[Size Setting]</b>.</li> <li>• <b>When resuming the print job:</b> Touch <b>[Continue]</b>. (Alternatively, press the  key to print.)</li> <li>• <b>When stopping the print job:</b> Touch <b>[Cancel]</b>. (Alternatively, press the  key or the  key to clear.)</li> </ul>
Check the Settings The Selected Reproduction Ratio will not fit the Max. Printing Area	<p>(Symptom) Reproduction size is too large for the detected original size and exceeds the maximum printing area.</p> <p>(Action) Modify the reproduction size, or set printing paper of the appropriate size.</p>	<ul style="list-style-type: none"> <li>• <b>When changing the “Size” setting:</b> Touch <b>[Size Setting]</b>.</li> <li>• <b>When resuming the print job:</b> Touch <b>[Continue]</b>. (Alternatively, press the  key to print.)</li> <li>• <b>When stopping the print job:</b> Touch <b>[Cancel]</b>. (Alternatively, press the  key or the  key to clear.)</li> </ul>
Close Platen Cover  If original moves you may not get desired result	<p>(Symptom) The Platen Cover was opened during the editing process of the RISO Editor function.</p> <p>(Action) Close the Platen Cover gently.</p>	<p>When the Platen Cover is closed, the warning message is erased. Touch <b>[Close]</b>. (Alternatively, press the  key or the  key to clear.)</p>











Message	Symptom/Action	How to Clear a Pop-Up Message
Enter Print Quantity Over [N], Programed Minimum Value	(Symptom) You are trying to print fewer copies than previously specified on "Minimum Print Quantity".  (Action) Enter a larger number to print, or change "Minimum Print Quantity" on the Admin. Screen. ☞ p.171	Touch <b>[Close]</b> , and specify the number of copies higher than the number displayed on the message.
!! Images may not fit in Frame of Paper with This Reproduction Size !! Check Current Selection	(Symptom) Reproduction size for the detected original size is larger than paper size.  (Action) Modify the reproduction size. ☞ p.61	<ul style="list-style-type: none"> <li>• <b>When resuming the print job:</b> Touch <b>[Continue]</b>. (Alternatively, press the  key to print.)</li> <li>• <b>When stopping the print job:</b> Touch <b>[Cancel]</b>. (Alternatively, press the  key or the  key to clear.)</li> </ul>
Invalid Print Drum has been Selected Change Print Drum, or Reselect Print Drum Size	(Symptom) You have selected a different Print Drum (Cylinder) than the one currently in place, as confirmed in the Confirm Print Drum (Cylinder) Type screen when it was installed.  (Action) Select the type of Print Drum (Cylinder) currently installed. Alternatively, you can change the Print Drum (Cylinder). ☞ p.211	<ul style="list-style-type: none"> <li>• <b>When changing a setting:</b> In the Confirm Print Drum (Cylinder) Type screen, select the type of Print Drum (Cylinder) currently installed and touch <b>[OK]</b>.</li> <li>• <b>When installing a different Print Drum (Cylinder):</b> Pull out the Print Drum (Cylinder) and replace with the correct one.</li> </ul> <p>When the Print Drum (Cylinder) is re-installed, the Warning Message will clear.</p>
!! Layout is not available with this paper size !! Replace with proper paper of standard size	(Symptom) Layout functions cannot be used when custom-sized papers are set in the Paper Feed Tray.  (Action) Load standard size paper in the Paper Feed Tray. ☞ p.34	Touch <b>[Close]</b> . (Alternatively, press the  key or the  key to clear.)
!! Multi-Up is Not Available with This Paper Size !! Replace with Proper Paper of Standard Size	(Symptom) Multi-up functions cannot be used when custom-sized paper is in the Feed Tray.  (Action) Load standard size paper in the Feed Tray.	Touch <b>[Close]</b> . (Alternatively, press the  key or the  key to clear.)





Message	Symptom/Action	How to Clear a Pop-Up Message
!! No Auto Reproduction Size Selection with This Combination of Original and Printing Paper !! Select Size Manually	(Symptom) With the size of set original and printing paper, auto reproduction cannot be performed.  (Action) Modify the reproduction size.	<ul style="list-style-type: none"> <li>• <b>When changing the “Size” setting:</b> Touch <b>[Size Setting]</b>.</li> <li>• <b>When stopping the print job:</b> Touch <b>[Cancel]</b>. (Alternatively, press the  key or the  key to clear.)</li> </ul>
!! No Auto Reproduction Size Selection with This Combination of Original and Printing Paper !! Select Size Manually	(Symptom) Auto Reproduction Size is less than 50% or more than 200%.  (Action) Modify the reproduction size.	<ul style="list-style-type: none"> <li>• <b>When changing the “Size” setting:</b> Touch <b>[Size Setting]</b>.</li> <li>• <b>When stopping the print job:</b> Touch <b>[Cancel]</b>. (Alternatively, press the  key or the  key to clear.)</li> </ul>
!! No Auto Reproduction with This Original and Printing Paper !! Select Size Manually	(Symptom) Auto reproduction is not available because the size of the original could not be detected.  (Action) Set the reproduction size manually.	<ul style="list-style-type: none"> <li>• <b>When changing the “Size” setting:</b> Touch <b>[Size Setting]</b>.</li> <li>• <b>When stopping the print job:</b> Touch <b>[Cancel]</b>. (Alternatively, press the  key or the  key to clear.)</li> </ul>
No Master on Print Drum Make a New Master	(Symptom) You are attempting to print, but there is no master on the Print Drum (Cylinder).  (Action) Set the original and create a master.	<p>Touch <b>[Close]</b>. Set the original and create a master.</p> <p><b>Important!:</b></p> <ul style="list-style-type: none"> <li>• Do not leave the Print Drum (Cylinder) without a master. This dries out the Print Drum (Cylinder) and causes damage. You must either create a master or perform a “Confidential” operation to wrap a master around the Print Drum (Cylinder).</li> </ul>
Original size exceeds limitation of layout Specify the original size	(Symptom) “Layout” is not available for the original size.  (Action) Specify the original size. ☞ p.80	<ul style="list-style-type: none"> <li>• <b>When changing the “Original Size” setting:</b> Touch <b>[Original Size]</b>.</li> <li>• <b>When resuming the print job:</b> Touch <b>[Continue]</b>. (Alternatively, press the  key to print.)</li> <li>• <b>When stopping the print job:</b> Touch <b>[Cancel]</b>. (Alternatively, press the  key or the  key to clear.)</li> </ul>
Original Size Exceeds Limitation of Multi-Up Specify Original Size	(Symptom) “Multi-Up” is not available for the original size.  (Action) Specify the original size. ☞ p.71	<ul style="list-style-type: none"> <li>• <b>When changing the “Original Size” setting:</b> Touch <b>[Original Size]</b>.</li> <li>• <b>When resuming the print job:</b> Touch <b>[Continue]</b>. (Alternatively, press the  key to print.)</li> <li>• <b>When stopping the print job:</b> Touch <b>[Cancel]</b>. (Alternatively, press the  key or the  key to clear.)</li> </ul>

Message	Symptom/Action	How to Clear a Pop-Up Message
Original Undetected Reset Original	(Symptom) The machine failed to detect the original document. The original document may not be placed.  (Action) Re-position the original.	<ul style="list-style-type: none"> <li>• <b>When resuming the print job:</b> Touch <b>[Continue]</b>. (Alternatively, press the  key to print.)</li> <li>• <b>When stopping the print job:</b> Touch <b>[Cancel]</b>. (Alternatively, press the  key or the  key to clear.)</li> </ul>
Page Format is Larger than Paper Size !! Possible Ink Smudges on Prints !!	(Symptom) The printing paper is smaller than the Master.  (Action) Use a correct size printer paper.	<ul style="list-style-type: none"> <li>• <b>When printing from the machine:</b> Touch <b>[Continue]</b>. (You can also print by pressing the  key or the  key.)</li> <li>• <b>When stopping the print job:</b> Touch <b>[Cancel]</b>. (You can also stop by pressing the  key or the  key.)</li> </ul>
Page Format is Larger than Paper Size !! Possible Ink Smudges on Prints !! (Continue->PROOF Key)	(Symptom) The printing paper is smaller than the Master.  (Action) Use a correct size printer paper.	<ul style="list-style-type: none"> <li>• <b>To override the message and to print with possible Ink smears on the roller:</b> Press the  key.</li> <li>• <b>When stopping the print job:</b> Touch <b>[Cancel]</b>. (You can also stop by pressing the  key or the  key.)</li> </ul>
Paper Size cannot be Defined by Specified Reproduction Size Select Paper Size Manually	(Symptom) The proper sized papers for the specified reproduction size are not set.  (Action) Select the Paper Tray.	<ul style="list-style-type: none"> <li>• <b>To select the Paper Tray:</b> Touch <b>[Paper Select]</b> or <b>[Manual Feed]</b> to select the Paper Tray.</li> <li>• <b>When stopping the print job:</b> Touch <b>[Cancel]</b>. (You can also stop by pressing the  key or the  key.)</li> </ul>
Please inform this message to your administrator Due date for ID counter report	(Symptom) Due date for ID Counter Report.  (Action) Report to your administrator. ☞ p.160	Touch <b>[Close]</b> . (Alternatively, press the  key or the  key to clear.)
!! Possible Multiple Paper Feed !! Check Printed Copies	Check printed copies.	Touch <b>[Cancel]</b> . (Alternatively, press the  key or the  key to clear.)  • <b>For canceling “D-Feed Check”</b> Touch <b>[D-Check OFF]</b> to change from being highlighted (b/w) to the normal display.

Message	Symptom/Action	How to Clear a Pop-Up Message
Printer Temperature is Low “High Speed” is Not Available	(Symptom) When the temperature of use is low, you cannot use “High Speed”.  (Action) Use the printer at the normal print speed until the temperature inside the printer increases to 15°C (59°F) or higher. When you touch “Continue”, printing at the normal speed starts. When you touch “Cancel”, the Printing Basic Screen appears.	<ul style="list-style-type: none"> <li>• <b>When resuming the print job:</b> Touch <b>[Continue]</b>. (Alternatively, press the  key to print.)</li> <li>• <b>When stopping the print job:</b> Touch <b>[Cancel]</b>. (Alternatively, press the  key or the  key to clear.)</li> </ul>
Processing Print Data from PC Scanning Mode is Not Available while Processing Current Data	The machine is receiving the document data from the computer. While the data is being transmitted, Scan Mode is disabled.	Touch <b>[Close]</b> . (Alternatively, press the  key to clear.)
Processing Print Data from PC This Function is Not Available while Processing Current Data	The machine is receiving the document data from the computer. While the data is being transmitted, Scan mode is disabled.	Touch <b>[Close]</b> . Initiate the Print job after the transmission is complete, or print from the machine.
-- Protect --  Discard Current Master	(Symptom) “Protect” function is set to ON.  (Action) Perform “Confidential” if necessary .  p.183	<ul style="list-style-type: none"> <li>• <b>To set the “Confidential”:</b> Touch <b>[OK]</b>.</li> <li>• <b>To cancel the “Confidential”:</b> Touch <b>[Cancel]</b>. (Alternatively, press the  key to clear.)</li> </ul>
Reached to the limit count Contact the administrator	(Symptom) The upper limit for master-making/ printing set by the administrator was reached.  (Action) Contact your Administrator.	Touch <b>[Close]</b> . (Alternatively, press the  key or the  key to clear.)
! Scanning is Not Possible ! External CI is not Connected or Processing Connection Check Cable Connection	(Symptom) The scanning function is unavailable due to a lost connection with an external controller or because connection processing has not finished.  (Action) Check the connection with the external controller.	Touch <b>[Close]</b> . (Alternatively, press the  key or the  key to clear.)
Starting Up Network Card  Please Wait a Moment	(Symptom) RISO Network Card is starting up.  (Action) Please wait a moment. Alternatively, print from the machine.	Touch <b>[Close]</b> . (Alternatively, press the  key or the  key to clear.)



Message	Symptom/Action	How to Clear a Pop-Up Message
!! The Data Storage Area has Become Full !! Clear Old Storage Data	(Symptom) Insufficient free space on the Document Storage Card.  (Action) Check the stored data and delete unnecessary jobs.	Touch <b>[Cancel]</b> . (Alternatively, press the  key or the  key to clear.)  • <b>For checking the storage memory:</b> Touch <b>[Storage Memory]</b> .
The file size is too large to store on USB Flash Drive Change the USB Flash Drive or delete some files to make spaces	(Symptom) Insufficient free space on the USB Flash Drive.  (Action) Check the USB Flash Drive data and delete unnecessary jobs.	Touch <b>[Close]</b> . (Alternatively, press the  key or the  key to clear.)  • <b>For checking the USB Flash Drive data:</b> Touch <b>[USB Job List]</b> .
!! The Number of Storage Data has Become Full !! Clear Old Storage Data in the Selected Folder	(Symptom) The selected folder is full of data.  (Action) Check the contents of the folder and delete unnecessary data. Alternatively, select another folder.	Touch <b>[Close]</b> . (Alternatively, press the  key or the  key to stop printing.)  • <b>When checking storage data:</b> Touch <b>[Storage Memory]</b> .
The Paper Feed Pressure Adjustment Lever is set to "CARD" Check if the setting is consistent with paper in the Standard Feed Tray	(Symptom) The "Paper Feed Adjustment" under "Administrator Settings" is set to "Auto", and the Paper Feed Pressure Adjustment Lever is at the "CARD" position.  (Action) Check the paper and adjust the position of the Paper Feed Pressure Adjustment Lever as needed. See "Setting up the Paper Feed Tray and Loading Paper" Step 4.  p.35	• <b>When resuming the print job:</b> Touch <b>[Continue]</b> . (Alternatively, press the  key to print.)  • <b>When stopping the print job:</b> Touch <b>[Cancel]</b> . (Alternatively, press the  key to stop printing.)
!!The Print Drum (Cylinder) Type has been Changed!! Select the Current Print Drum (Cylinder) Type	(Symptom) A different type of Print Drum (Cylinder) has been installed.  (Action) Select the type of Print Drum (Cylinder) currently installed. Alternatively, change back to the same type of Print Drum (Cylinder) as before.  p.211	• <b>When changing a setting:</b> In the Confirm Print Drum (Cylinder) Type screen, select the type of Print Drum (Cylinder) currently installed and touch <b>[OK]</b> .  • <b>When installing a different Print Drum (Cylinder):</b> Pull out the Print Drum (Cylinder) and replace with the same one as before.  When the Print Drum (Cylinder) is re-installed, the Warning Message will clear.

Message	Symptom/Action	How to Clear a Pop-Up Message
<p>!! Unmatched Paper Size !!                      Interposal Paper is Smaller than Printing Paper                      Check Interposal Paper Size</p>	<p>(Symptom)                      Interposal Papers are smaller than paper size.</p> <p>(Action)                      Load Interposal Papers of appropriate size in the tray.</p>	<p>Touch <b>[Close]</b>.                      (Alternatively, press the  key or the  key to clear.)</p>
<p>!! Unmatched Size--                      Current Page and Printing Paper !!                      Check Paper Size</p>	<p>(Symptom)                      The original data sent from the computer does not match the print paper size.</p> <p>(Action)                      Check the print paper size and change paper or size as needed.</p>	<ul style="list-style-type: none"> <li>• <b>When resuming the print job:</b>                      Touch <b>[Continue]</b>.                      (Alternatively, press the  key to print.)</li> <li>• <b>When stopping the print job:</b>                      Touch <b>[Cancel]</b>.                      (Alternatively, press the  key or the  key to clear.)</li> </ul>



## Consumable Information Screen

In order to assure optimum printing, the machine acquires information from the consumables. If acquired matching information is not proper, the Consumable Information Screen is shown. Enter appropriate values.

The  icon on the Info Button will be grayed out when this occurs.

 p.203

### Note:

- Entering an inappropriate value does not affect usual operations but may result in bad print quality.
- When you perform the following operations, the values set on the “Consumables Information Input Wizard” Screen disappears and thus you need to enter the values again.
  - After the power switch is set to  (OFF) and the switch is set to  (ON) again
  - After the machine is placed into the Sleep status.
  - After the  key is pressed

## Ink Information Input Screen

This screen pops up when data could not be obtained from the Ink Cartridge.

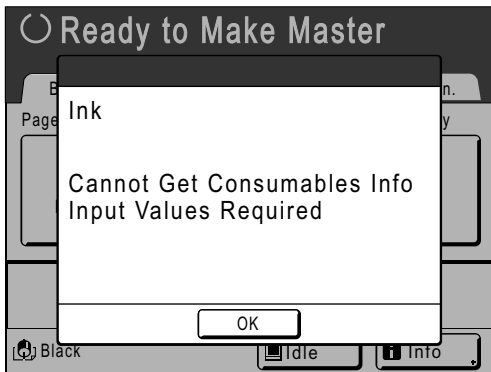

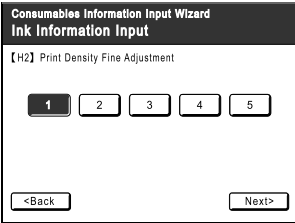
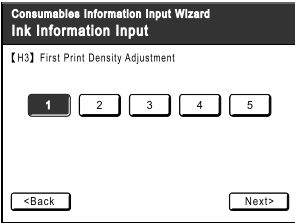

Touch **[OK]** and enter values as shown below.

Screen Display	Description	Values
	<p>[H1] Ink Color Setting                      Select the same color as the Print Drum (Cylinder) currently in use.</p>	<p>1: Black 2: Color</p>

Screen Display	Description	Values
	<p>[H2] Print Density Fine Adjustment Select a Print Density level to match the Ink to fine-tune print result.</p>	<p>1 (Light) - 5 (Dark)</p>
	<p>[H3] First Print Density Adjustment Select a Print Density level of the first print to match the Ink. This can be selected independent of [H2] Print Density Fine Adjustment setting.</p>	<p>1 (Light) - 5 (Dark)</p>

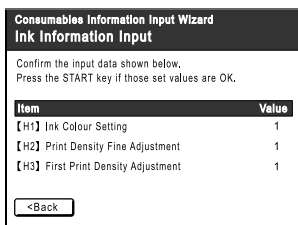
A confirmation screen displays when done.



Press the  key to approve selection.  
Returns to the Basic Screen.

**Note:**

- Master Information Input Screen may also display. If so, enter Master Information as well.  
p.242

**Master Information Input Screen**

This screen pops up when data could not be obtained from the Master Roll.  
Touch [OK] and enter values as shown below.

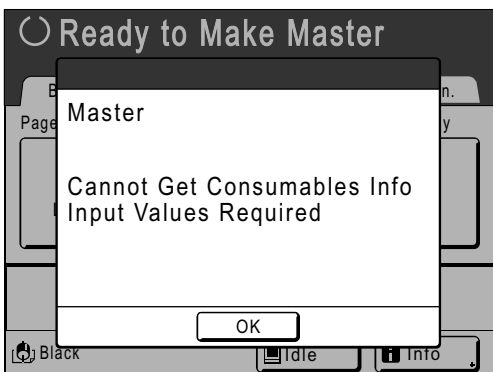

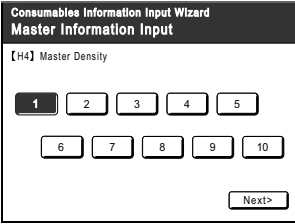
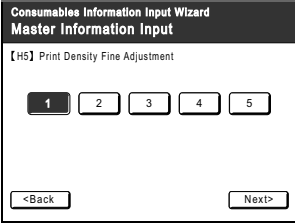
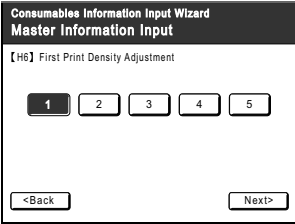
Screen Display	Description	Values
	<p>[H4] Master Density Select the standard density to be applied during creation of the master.</p>	<p>1 (Light) - 10 (Dark)</p>
	<p>[H5] Print Density Fine Adjustment Select a Print Density level to match the master to fine-tune print result.</p>	<p>1 (Light) - 5 (Dark)</p>
	<p>[H6] First Print Density Adjustment Select a Print Density level of the first print to match the master. This can be selected independent of [H5] Print Density Fine Adjustment.</p>	<p>1 (Light) - 5 (Dark)</p>



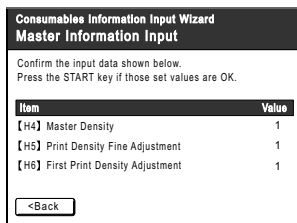





A confirmation screen displays when done.



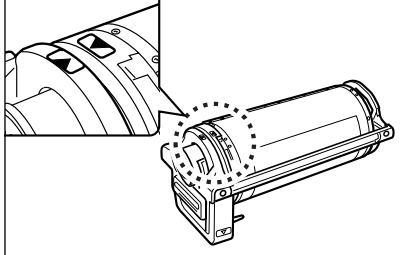

Press the  key to approve selection.  
Returns to the Basic Screen.

# Troubleshooting



If you run into a problem, consult the following chart first, to find answers before calling for a repair.

Problem	Possible Cause	Action
<p>The machine does not start up when the power switch is pressed.</p>	<p>You may have pressed the power switch while the machine was in the Sleep Mode.</p>	<p>Try pressing the power switch again. Before pressing the power switch, you may want to find out whether the machine is indeed in the Sleep Mode, by checking the  indicator on the Control Panel. If the  key is lit, the machine is in sleep mode. Press the  key to end sleep mode and to activate the machine.</p>
	<p>Power has been disconnected.</p>	<ul style="list-style-type: none"> <li>• Check the power cord for proper connection to both the machine and the electrical outlet.</li> <li>• Check the power breaker.</li> </ul>
<p>The front cover is closed, but the error message still does not clear.</p>	<p>The Front Cover has not been firmly closed.</p>	<p>Completely close the Front Cover. The magnetic latch should properly engage.</p>
<p>The Paper Feed Tray cannot be closed.</p>	<p>The Feed Paper Tray Guides have not been widened up to the limit.</p>	<p>Turn the power on and lower the Paper Feed Tray to the bottom. Set the Feed Tray Paper Guide Lock Lever to  , widen the Feed Tray Paper Guides up to the limit, and close the Paper Feed Tray.</p>
	<p>The power was turned off before the Paper Feed Tray was lowered to the bottom.</p>	
<p>The Print Drum (Cylinder) cannot be placed into position.</p>	<p>The Print Drum (Cylinder) was stopped at an inappropriate position after rotation.</p>	<p>After manually rotating the Print Drum (Cylinder), make sure that the  mark and the  mark meet as shown.</p> 
	<p>The Print Drum (Cylinder) has not been correctly set to the guide.</p>	<p>Set the Print Drum (Cylinder) to the guide correctly.   p.213</p>

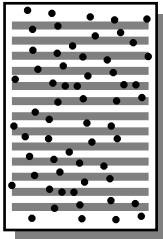

Problem	Possible Cause	Action
<p>An error indication does not disappear even though consumables (Ink, master roll) are set.</p>	<p>The consumables (Ink, master roll) have not been correctly set.</p>	<p>After inserting the Ink Cartridge, turn it clockwise (🔒) to lock. Or set the Ink Cartridge again. 🔗p.207</p> <p>Set a master roll so that the 📄 mark comes to the left, and set the Master Making Unit. 🔗p.204</p>
	<p>The Ink Cartridge does not contain Ink information.</p>	<p>Do not remove the label attached on the Ink Cartridge outlet section. If you did so, set a new Ink Cartridge. 🔗p.207</p>
	<p>The master roll does not contain master information.</p>	<p>Do not remove the 📄 section from the master core. If you did so, set a new master roll. 🔗p.204</p>
<p>The Master Disposal Box cannot be removed.</p>	<p>The “Protect” setting is ON.</p>	<p>If the “Protect” setting is ON, the Master Disposal Box cannot usually be removed. 🔗p.182</p>
	<p>The Master Disposal Box lever is locked.</p>	<p>Slide the Master Disposal Box lever to the right to unlock. If the Master Disposal Box is padlocked, contact the administrator to undo the padlock. 🔗p.209</p>
<p>There is no image on copies.</p>	<p>The original is placed face up.</p>	<p>Check which side of the original was placed on the Glass Platen or in the ADF unit. See “Placing the original” (🔗p.41).</p>
	<p>The master is installed with the incorrect side out.</p>	<p>Reinstall the Master Roll with correctly. 🔗p.204</p>
<p>Some areas are missing in the printed copy.</p> 	<p>The Glass Platen (and/or the ADF Scanner Glass) is not clean.</p>	<p>Clean the Glass Platen (and/or the ADF Scanner Glass). 🔗p.216</p>
	<p>A foreign object may exist on the master.</p>	<p>Pull out the Print Drum (Cylinder) and check if any object exists on the master. If a foreign object exists between the master and the Print Drum (Cylinder), remove the master. Then set the Print Drum (Cylinder) and perform the master-making operation again.</p>
	<ul style="list-style-type: none"> <li>• The paper size placed on the Feed Tray was not the same as the size of the original at the time of the master-making process.</li> <li>• The Feed Tray Paper Guides were not fit to the width of paper at the time of the master-making process.</li> </ul>	<p>A master is made according to the size of paper placed on the Feed Tray; namely the width of the Feed Tray Paper Guides and the length of paper. If the size of paper placed on the tray is smaller than the size of the original, a master is not made for the entire original. Set the same size of paper on the tray as the original and perform the master-making operation.</p>

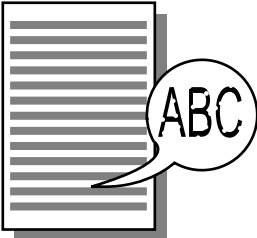
Problem	Possible Cause	Action
<p>Vertical blank lines are found on printed copies.</p> 	<p>The Thermal Print Head of the Master Making Unit or the Scanner Glass of Auto Document Feeder has been stained with dirt, white-out, etc.</p>	<p>Gently wipe the Thermal Print Head or Scanner Glass with a soft cloth. ☞ p.216</p>
<p>The unwanted background of an original is picked up on copies.</p> 	<p>If newspaper or colored paper is used as an original, the background is picked up in the copies.</p>	<p>Lighten the “Contrast” and create a new master. ☞ p.60</p>
<p>Dirt is found on printed copies.</p>	<p>The Glass Platen (and/or the ADF Scanner Glass) is not clean.</p>	<p>Clean the Glass Platen (and/or the ADF Scanner Glass). ☞ p.216</p>
<p>The edges of printed copies are smudged with Ink.</p>	<p>Larger size of paper than the original was placed on the Paper Feed Tray at the time of the master-making process.</p>	<p>Because a master was made according to a larger size than the original, the edges of the original were processed as shadows. Set the same size of paper as the original and perform the master-making operation again. Or attach tape as described below to solve the problem.</p>
	<p>Did you use <b>[Max. Scan]</b> setting when making the master?</p>	
	<p>When printing thick paper such as cards, corners of the paper contacted and damaged the master.</p>	<p>Make another master and print with the new master. Or pull out the Print Drum (Cylinder) and attach cellophane tape to the damaged section on the master. However, if attached with cellophane tape, a master may not be properly sent to the Master Disposal Box.</p>



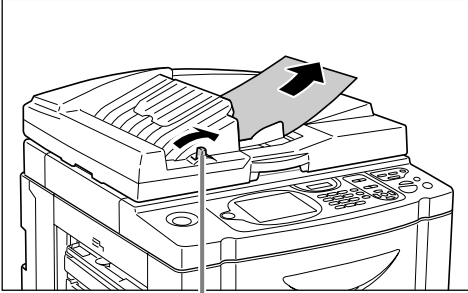
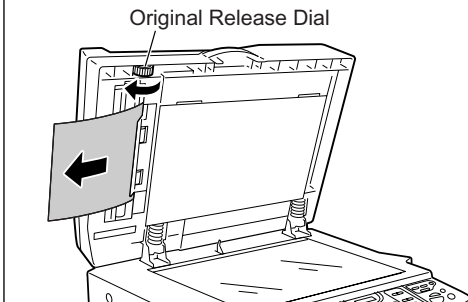

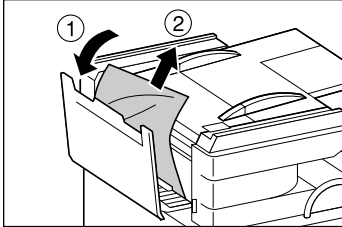

Problem	Possible Cause	Action
<p>The back of the printed paper is smudged with Ink</p> 	<p>The Pressure Roller has been stained with Ink.</p>	<p>Remove the Print Drum (Cylinder) and clean the Pressure Roller.                      ☞ p.216                      If the print position is outside the print paper, this may cause the Pressure Roller to be stained with Ink.                      Be careful when changing the size of print paper or shifting the print position.</p>
	<p>The Feed Tray Paper Guides were not fit to the width of paper at the time of the master-making process.</p>	<p>Adjust the Feed Tray Paper Guides to the width of the paper.                      If the Feed Tray Paper Guides are set wider than the width of the paper, a master will become wider than necessary.                      ☞ p.34</p>
	<p>Are you using a paper that does not efficiently absorb Ink?</p>	<p>The Ink did not dry fast enough, marking onto the reverse side of the next paper. Either change the paper or try “Ink Saving” or “Interval” features.                      ☞ p.70                      ☞ p.104</p>
<p>Printed images are faint. Printed texts are blurred.</p> 	<p>If the machine is not used for an extended period of time, Ink on the surface of the Print Drum (Cylinder) may dry. This results in faint or blurred printing just after printing starts.</p>	<p>The Ink on the Print Drum (Cylinder) will dry when the machine is not in use for an extended period. Printing with dried Ink will produce light or faded copies. Press the  key and make several copies before making copies to be actually used. Or use the “Idling Action”.                      ☞ p.149</p>
	<p>Faint originals result in faint images.</p>	<p>Increase the scanning level and perform the master-making operation again.                      ☞ p.60                      For originals written with a pencil, select the Pencil mode.                      ☞ p.58</p>
	<p>If the temperature is low (below 15°C (59°F)) in a place where the machine is installed or Ink Cartridges are stored, Ink does not flow smoothly.</p>	<p>Use the machine after keeping it at room temperature for a while.                      ☞ p.10</p>
	<p>The Ink Saving mode has been set.</p>	<p>With the “Ink Saving” mode selected, the Ink on printed copies is fainter than usual.                      ☞ p.70</p>
<p>The position of printed text is shifted to the left or right.</p>	<p>The left/right position control was not set to “Center” when the document was printed.</p>	<p>First lower the Paper Feed Tray, then adjust the position and print a proof copy to check the new position.                      ☞ p.100</p>
	<p>Are the Paper Guides set properly?</p>	<p>Make sure to align the Paper Guides with the paper, and turn the Paper Guide Lock Levers until they are secured. See “Preparing to Print” (☞ p.34).</p>

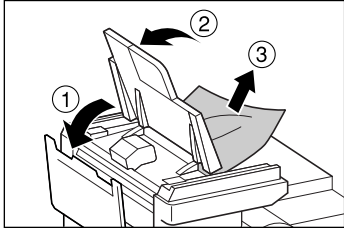
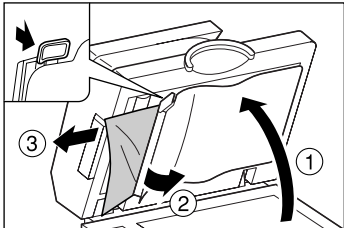
Problem	Possible Cause	Action
<p>Paper sticks to the surface of the Print Drum (Cylinder).</p>	<p>The margin at the top of the original or print is too small.</p>	<p>The margin of the original (top of the print in the paper output direction) must be 5mm (<math>\frac{3}{16}</math>" ) at least. Lower the vertical print position. If this adjustment is impossible, reproduce an original with enough margin and perform the master-making operation again.                      ☞ p.61</p>
	<p>The print paper is inappropriate.</p>	<p>Use the recommended paper.                      ☞ p.16</p>
	<p>The original has a solid black portion at its top.</p>	<p>If an original has a solid black portion at the top, printed copies may not be with proper quality. Replace the original in the reverse direction and restart the master-making process.</p>
<p>Printed and curled copies are output.</p>	<p>The print paper is loaded at a horizontal grain direction.</p>	<p>Load print paper with a vertical grain direction.</p>
<p>Paper gets jammed in the Auto Document Feeder AF-VI:II (option).</p>	<p>There is any paper caught in the Auto Document Feeder AF-VI:II.</p>	<p>Pull the ADF Original Release Lever to the right or turn the Release Original Dial and remove the jammed paper.</p> <div style="text-align: center;">  <p>ADF Original Release Lever</p> </div> <div style="text-align: center;">  <p>Original Release Dial</p> </div>

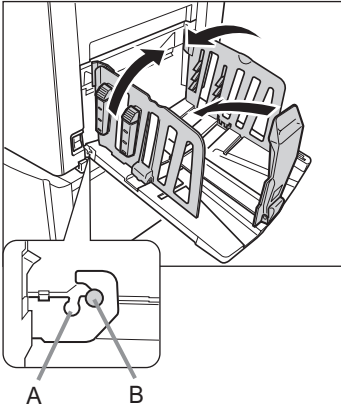
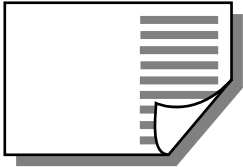
Problem	Possible Cause	Action
<p>Paper gets jammed in the Auto Document Feeder DX-1 (option).</p>	<p>Paper is caught in the Auto Document Feeder DX-1.</p>	<p><b>Removing originals jammed in the document carrier</b>            Open the ADF cover (①), and raise the feed roller as shown in (②).</p>  <p><b>Important!:</b></p> <ul style="list-style-type: none"> <li>• Take care not to touch the roller inside the unit. It may cause smudges on the original or a paper jam.</li> </ul> <p><b>Removing originals jammed in the document carrier</b>            Open the ADF cover (①), and raise the feed roller as shown in (②).            Open the inside cover (③), and pull out the original (④).</p> 

Problem	Possible Cause	Action
<p>Paper gets jammed in the Auto Document Feeder DX-1 (option).</p>	<p>There is any paper caught in the Auto Document Feeder DX-1.</p>	<p><b>Removing originals jammed in the original reversal unit</b>                      Open the auto document feeder cover (①), and raise the document tray as shown in (②).                      Pull out the original (③).</p>  <p><b>Removing originals jammed in the original receiving unit</b>                      Lift the Platen Cover Pad up (①), and pull the release lever toward you (②), and pull out the original (③).</p> 
<p>Printed copies are not neatly aligned in the Paper Receiving Tray.</p>	<p>The positions of the Receiving Tray Paper Guides and the Paper Stopper are inappropriate.</p>	<p>Adjust the Receiving Tray Paper Guides and the Paper Stopper to the size of paper. For thick paper, slightly widen them as necessary.                      If you have adjusted the horizontal position on the Paper Feed Tray, shift the Receiving Tray Paper Guides in the same direction.                      ☞ p.37</p>
	<p>The Paper Arrangers are not properly set.</p>	<p>Set the Paper Arrangers properly.                      ☞ p.37</p>
	<p>The Paper Feed Pressure Adjustment Lever is positioned incorrectly.</p>	<p>If the Paper Feed Pressure Adjustment Lever is set to "Thick Paper", printed copies may not be correctly aligned when using standard paper.                      Set the Paper Feed Pressure Adjustment Lever to "Standard".                      ☞ p.34</p>

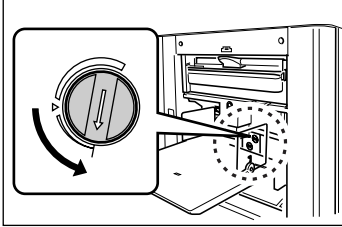
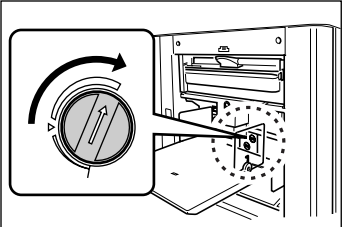

Problem	Possible Cause	Action
<p>Paper goes over the receiving tray stopper.</p>	<p>---</p>	<p>Follow the steps to level the receiving tray as follows:</p> <ol style="list-style-type: none"> <li>1) Fold the Receiving Tray Paper Guides/Stopper.</li> <li>2) Lift up the sides of the receiving tray with both hands, and move the receiving tray shaft to position B. Position A is recommended in most cases.</li> </ol>  <p>A: Ordinary position B: Move to this position when paper goes over the tray.</p>
<p>Paper is not smoothly fed from the Paper Feed Tray. (skipped paper, or multiple-sheet feeding)</p>	<p>The print paper is inappropriate.</p>	<p>Use paper that falls within the recommended range. ☞ p.16</p>
	<p>The position of the Paper Feed Pressure Adjustment Lever was inappropriate.</p>	<p>When using thick or slippery paper, set the Paper Feed Pressure Adjustment Lever to “Thick Paper”. ☞ p.34</p>
<p>Multi-up did not function. There is nothing printed on one side.</p> 	<p>Did you place the second original in time after the beep, while the message “Place Another Original and Press Start Key” was showing?</p>	<p>When you print using “Multi-Up”, the machine will beep during the Multi-Up Interval. Place the second original during that interval. If the machine starts scanning for the second time without a beep, even when you are scanning from the Glass Platen, you will need to adjust “Multi-Up Interval” settings on the Admin. Screen. ☞ p.173</p>
	<p>Did you accidentally press the  key while the original was being scanned?</p>	<p>The print operation will stop if the  key is pressed while scanning is in progress. Do not press the  key until all originals have been scanned.</p>

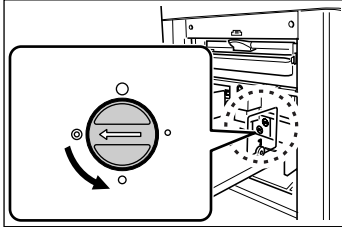
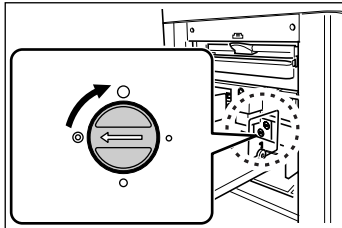
Problem	Possible Cause	Action
<p>Paper is not fed smoothly from the Paper Feed Tray. (Skipped paper, or multiple-sheet feeding)</p>	<p>The angle of the Stripper Plate is inappropriate.</p>	<p>Turn the Stripper Plate Angle Adjustment dial as follows;</p> <ul style="list-style-type: none"> <li>• <b>When the feeding skips</b> Turn the dial to the left.</li> </ul>  <ul style="list-style-type: none"> <li>• <b>When multiple sheets are fed</b> Turn the dial to the right.</li> </ul>  <p><b>Important!:</b></p> <ul style="list-style-type: none"> <li>• Before making the adjustment, be sure to remove all papers from the Paper Feed Tray and confirm that the tray is lowered to the bottom.</li> </ul>

Problem	Possible Cause	Action
<p>Paper is not smoothly fed from the Paper Feed Tray. (Skipped paper, or multiple-sheet feeding)</p>	<p>Paper handling pressure is not correctly adjusted.</p>	<ul style="list-style-type: none"> <li>• <b>For paper that easily creates paper powder, skips, or for the back side of postcards that is turn up:</b> Turn the dial to the left.</li> </ul>  <ul style="list-style-type: none"> <li>● : Normal</li> <li>○ : Strong</li> <li>◐ : Medium</li> <li>◑ : Weak</li> </ul> <ul style="list-style-type: none"> <li>• <b>If paper is being multi-fed:</b> Turn the dial to the right.</li> </ul>  <p><b>Important!:</b></p> <ul style="list-style-type: none"> <li>• Before making the adjustment, be sure to remove all papers from the Paper Feed Tray and confirm that the tray has lowered to the bottom.</li> </ul>
	<p>The Paper Feed Adjustment on the Functions Screen is not properly set.</p>	<p>Adjust the “Paper Feed Adj.”. Contact your dealer (or authorized service representative) for details on making the adjustment.</p>
<p>The back of the printed card is peeling, or the leading edge gets wrinkled.</p>	<p>The angle of the Stripper Plate is in appropriate</p>	<p>Turn the Stripper Plate Angle Adjustment Dial to adjust the angle.</p>
<p>An error message displays even though there is no paper jam.</p>	<p>Is the lifted paper getting ejected at the second rotation of the Print Drum (Cylinder)?</p>	<p>Check the printed copy, and if the top margin is less than 5 mm (<math>\frac{3}{16}</math>"), slightly lower Print Position.</p>
	<p>Is sunlight directly hitting the machine?</p>	<p>The sensor is affected by direct sunlight. Install shades or curtains, or move the machine out of direct sunlight.</p>
<p>When printing a multiple page computer file, the machine repeats the master-making process one page at a time.</p>	<p>Is “Print in Units” option selected in the Printer Driver?</p>	<p>Delete the current print job. Deselect “Print in Units”, and resend the data to the machine. See <a href="#">p.48</a>, step 3. <a href="#">p.55</a></p>

## Troubleshooting

---

Problem	Possible Cause	Action
The computer sent the file, but it was not received by the machine.	Is the Admin. Screen currently showing on the display?	Touch  and switch to the Basic Screen from the Admin. Screen.
The  key is lighting.	Received data is waiting for output?	Press the  key and proceed to print.





# Appendix

## Optional Accessories

A variety of optional accessories are available to enhance the capabilities of the machine. For details about the optional accessories, see your dealer (or authorized service representative).

### ◆ Auto Document Feeder AF-VI:II

Feed up to 50 sheets of originals automatically.

### ◆ Auto Document Feeder DX-1

Feed up to 50 sheets of originals automatically. Both sides of original can be scanned automatically.

### ◆ Color Drum (Cylinder)

Simply change the Drum (Cylinder) to print in multiple colors. (Case included)

### ◆ Auto-control Stacking Tray II

The Receiving Tray Paper Guides/Stopper are automatically adjusted according to the paper and reproduction size.

### ◆ Wide Stacking Tray

This unit can take paper up to 340 mm × 555 mm (13<sup>3</sup>/<sub>8</sub>" × 21<sup>27</sup>/<sub>32</sub>" in size.

### ◆ Key Card Counter

With a single button press, shows the numbers of printed copies and consumed masters within a given period of time. This can help you manage costs.

### ◆ Job Separator

With the Programed Printing function, allows the machine to print and sort into groups separated by tape.

### ◆ Document Storage Card DM-128CF/DM-512CF

A Storage Card for using the Storage Memory function.

### ◆ RISO Controller IS300

A custom controller enabling the machine to be used as a network-connected PostScript 3 printer.

### ◆ Stand D type

### ◆ Stand N type

### ◆ Card Feed Kit

### ◆ Envelope Feed Kit

### ◆ RISO Printer Driver for Macintosh

# Specifications

## RISO SE9480

Master-making/printing methods	High-speed digital master-making/full automatic stencil printing
Original Type	Book (10 kg (22 lb) or less), sheet
Original Size (min./max.)	When using the Glass Platen: 50 mm × 90 mm (1 <sup>31</sup> / <sub>32</sub> " × 3 <sup>17</sup> / <sub>32</sub> ") - 310 mm × 432 mm (12 <sup>7</sup> / <sub>32</sub> " × 17") When using the Auto Document Feeder AF-VI:II (option): 100 mm × 148 mm (3 <sup>15</sup> / <sub>16</sub> " × 5 <sup>13</sup> / <sub>16</sub> ") - 310 mm × 432 mm (12 <sup>7</sup> / <sub>32</sub> " × 17") When using the Auto Document Feeder DX-1 (option): 105 mm × 128 mm (4 <sup>1</sup> / <sub>8</sub> " × 5 <sup>1</sup> / <sub>32</sub> ") - 297 mm × 432 mm (11 <sup>11</sup> / <sub>16</sub> " × 17")
Original Paper Weight	When using the Auto Document Feeder AF-VI:II (option): 50 g/m <sup>2</sup> (13-lb bond) - 128 g/m <sup>2</sup> (34-lb bond) When using the Auto Document Feeder DX-1 (option): Single-sided feeding: 40 g/m <sup>2</sup> (11-lb bond) - 128 g/m <sup>2</sup> (34-lb bond) Duplex-sided feeding: 52 g/m <sup>2</sup> (14-lb bond) - 105 g/m <sup>2</sup> (28-lb bond)
Printing Paper Size (min./max.)	100 mm × 148 mm (3 <sup>15</sup> / <sub>16</sub> " × 5 <sup>13</sup> / <sub>16</sub> ") - 320 mm × 432 mm ( 12 <sup>19</sup> / <sub>32</sub> " × 17")* *Paper up to 555 mm (21 <sup>27</sup> / <sub>32</sub> " ) from top to bottom may be used in the Extended Paper mode.
Paper Supply Capacity	Approx. 1000 sheets (64 g/m <sup>2</sup> (17-lb bond) - 80 g/m <sup>2</sup> (21-lb bond)) / Maximum Height 110 mm (4 <sup>11</sup> / <sub>32</sub> " )
Paper Receiving Capacity	Approx. 1000 sheets (64 g/m <sup>2</sup> (17-lb bond) - 80 g/m <sup>2</sup> (21-lb bond)) / Maximum Height 110 mm (4 <sup>11</sup> / <sub>32</sub> " )
Printing Paper Weight	46 g/m <sup>2</sup> (12-lb bond) - 210 g/m <sup>2</sup> (110-lb index)
Image Processing mode	Line, Photo (Standard/Portrait/Group), Duo (Line/Photo/Shadow off), Pencil (Darker/Lighter)
Master-making Time	Approx. 19 seconds (for Letter/short edge feed/100% reproduction ratio) Approx. 16 seconds (for Letter/long edge feed/100% reproduction ratio)
Printing Area (max.)	291 mm × 425 mm (11 <sup>15</sup> / <sub>32</sub> " × 16 <sup>23</sup> / <sub>32</sub> " )
Print Reproduction Ratio	Zoom: 50 - 200% Standard reproduction ratio (enlargement): 200%, 154%, 129%, 121% Standard reproduction ratio (reduction): 78%, 65%, 61%, 50% Margin+: 90 - 99 %
Print Speed	60 - 130 sheets per minute (control panel: five steps variable) 180 - 185 sheets per minute (Touch panel:"High Speed")
Print Position Adjustment	Vertical: ±15 mm (±1 <sup>9</sup> / <sub>32</sub> " ) Horizontal: ±10 mm (±2 <sup>5</sup> / <sub>64</sub> " )
Ink Supply	Fully automatic (1000 ml per cartridge)
Master Supply/Disposal	Fully automatic (approx. 215 sheets per roll)
Master Disposal Capacity	100 sheets
User Interface	LCD Touch Panel with Progress Arrow indicators

Optional Accessories	Auto Document Feeder AF-VI:II, Auto Document Feeder DX-1, Color Print Drum (Cylinder), Auto-Control Stacking Tray, Wide Stacking Tray, Key Card Counter, Job Separator, Document Storage Card DM-128CF/DM-512CF, RISO Controller IS300, Stand D type, Stand N type, Card Feed Kit, Envelope Feed Kit, RISO Printer Driver for Macintosh
Operating Noise	Max. 66 dB(A) (when printing 100 sheets per minute)
Power Source	AC 100-240 V, 50-60 Hz <5.0-2.2 A>
Power Consumption	Max. 400 W (100 V)/380 W (220 V) At Ready: approx. 52 W (100 V)/52 W (220 V) At Sleep: approx. 3.0 W (100 V)/4.0 W (220 V)
Functions	Idling, Print Speed Adjustment, Silent mode, Confidential mode, Auto-Process, Job Memory, Ink Saving, Layout, Binding Margin, Reservation, Output Reversal, Proof, Double Feed Check, User Management, Management of Consumables, Contrast Adjustment, Print Density Adjustment, Print Position Adjustment, Tone Curve, Jump Wing Control, Top Margin, Paper Size detection, Renew Page, Dot Process (4 types), Preview, Rotate, Scanning Side (with optional ADF DX-1), Admin. Mode, Interval Printing, Max. Scan, Special Paper Control, Auto 90° Rotation, Protect, Paper Size Selection, Overlay (with optional memory card or USB Flash Drive), Direct Print, Storage memory (with optional memory card), Scan Mode (with optional memory card or USB Flash Drive), My Direct Access, ID Counter Report, USB Job List (with USB Flash Drive), Custom Paper Entry, Programmed Printing (2 types), Direct Access Entry, Selections Entry, Book Shadow, RISO i Quality System, Scanning Contrast (Manual/Auto), Multi-Up Print (2 up/Single-Original/Multiple-Original/Multi-Up Tickets), ADF Semi-Auto (with optional ADF unit installed), Energy Saving Mode (Auto Sleep. Auto Power-OFF), ECO Mode
Dimensions	When in use: 1415 mm(W) × 705 mm(D) × 665 mm(H) (55 <sup>23</sup> / <sub>32</sub> "(W) × 27 <sup>3</sup> / <sub>4</sub> "(D) × 26 <sup>3</sup> / <sub>16</sub> "*(H)) When in storage: 780 mm(W) × 705 mm(D) × 665 mm(H) (30 <sup>23</sup> / <sub>32</sub> "(W) × 27 <sup>3</sup> / <sub>4</sub> "(D) × 26 <sup>3</sup> / <sub>16</sub> "*(H))
Required Space* <sup>1</sup>	1655 mm (W) x 1310 mm (D) x 1505 mm (H) (65 <sup>5</sup> / <sub>32</sub> " (W) x 51 <sup>9</sup> / <sub>16</sub> " (D) x 59 <sup>1</sup> / <sub>4</sub> " (H))
Weight* <sup>2</sup>	Approx. 115 kg (254 lb)
Safety Standards	IEC-60950-1 compliant, Indoor, pollution degree 2* <sup>3</sup> , At altitudes of 2000 m or lower

**Note:**

- Please note that due to improvements and changes to the machine, some images and explanations in this manual may not correspond to your machine.
- The specifications are subject to change without prior notice.

\*1 The height includes the height of the dedicated stand.

\*2 The weight does not include Ink and Master.

\*3 The pollution degree of the usage environment due to dirt and dust in the air. Degree "2" corresponds to general indoor environment.

**RISO SE9380**

Master-making/printing methods	High-speed digital master-making/full automatic stencil printing
Original Type	Book (10 kg (22 lb) or less), sheet
Original Size (min./max.)	When using the Glass Platen: 50 mm × 90 mm (1 <sup>31</sup> / <sub>32</sub> " × 3 <sup>17</sup> / <sub>32</sub> ") - 310 mm × 432 mm (12 <sup>7</sup> / <sub>32</sub> " × 17") When using the Auto Document Feeder AF-VI:II (option): 100 mm × 148 mm (3 <sup>15</sup> / <sub>16</sub> " × 5 <sup>13</sup> / <sub>16</sub> ") - 310 mm × 432 mm (12 <sup>7</sup> / <sub>32</sub> " × 17") When using the Auto Document Feeder DX-1 (option): 105 mm × 128 mm (4 <sup>1</sup> / <sub>8</sub> " × 5 <sup>1</sup> / <sub>32</sub> ") - 297 mm × 432 mm (11 <sup>11</sup> / <sub>16</sub> " × 17")
Original Paper Weight	When using the Auto Document Feeder AF-VI:II (option): 50 g/m <sup>2</sup> (13-lb bond) - 128 g/m <sup>2</sup> (34-lb bond) When using the Auto Document Feeder DX-1 (option): Single-sided feeding: 40 g/m <sup>2</sup> (11-lb bond) - 128 g/m <sup>2</sup> (34-lb bond) Duplex-sided feeding: 52 g/m <sup>2</sup> (14-lb bond) - 105 g/m <sup>2</sup> (28-lb bond))
Printing Paper Size (min./max.)	100 mm × 148 mm (3 <sup>15</sup> / <sub>16</sub> " × 5 <sup>13</sup> / <sub>16</sub> ") - 320 mm × 432 mm (12 <sup>19</sup> / <sub>32</sub> " × 17")* *Paper up to 555 mm (21 <sup>27</sup> / <sub>32</sub> ") from top to bottom may be used in the Extended Paper mode.
Paper Supply Capacity	Approx. 1000 sheets (64 g/m <sup>2</sup> (17-lb bond) - 80 g/m <sup>2</sup> (21-lb bond)) / Maximum Height 110 mm (4 <sup>11</sup> / <sub>32</sub> ")
Paper Receiving Capacity	Approx. 1000 sheets (64 g/m <sup>2</sup> (17-lb bond) - 80 g/m <sup>2</sup> (21-lb bond)) / Maximum Height 110 mm (4 <sup>11</sup> / <sub>32</sub> ")
Printing Paper Weight	46 g/m <sup>2</sup> (12-lb bond) - 210 g/m <sup>2</sup> (110-lb index)
Image Processing mode	Line, Photo (Standard/Portrait/Group), Duo (Line/Photo/Shadow off), Pencil (Darker/Lighter)
Master-making Time	Approx. 20 seconds (for A4/short edge feed/100% reproduction ratio) Approx. 16 seconds (for A4/long edge feed/100% reproduction ratio)
Printing Area (max.)	291 mm × 413 mm (11 <sup>15</sup> / <sub>32</sub> " × 16 <sup>1</sup> / <sub>4</sub> ")
Print Reproduction Ratio	Zoom: 50 - 200% Standard reproduction ratio (enlargement): 163%, 141%, 122%, 116% Standard reproduction ratio (reduction): 87%, 82%, 71%, 61% Margin+: 90 - 99 %
Print Speed	60 - 130 sheets per minute (control panel: five steps variable) 180 - 185 sheets per minute (Touch panel:"High Speed")
Print Position Adjustment	Vertical: ±15 mm (± <sup>19</sup> / <sub>32</sub> ") Horizontal: ±10 mm (± <sup>25</sup> / <sub>64</sub> ")
Ink Supply	Fully automatic (1000 ml per cartridge)
Master Supply/Disposal	Fully automatic (approx. 220 sheets per roll)
Master Disposal Capacity	100 sheets
User Interface	LCD Touch Panel with Progress Arrow indicators
Optional Accessories	Auto Document Feeder AF-VI:II, Auto Document Feeder DX-1, Color Print Drum (Cylinder), Auto-Control Stacking Tray, Wide Stacking Tray, Key Card Counter, Job Separator, Document Storage Card DM-128CF/DM-512CF, RISO Controller IS300, Stand D type, Stand N type, Card Feed Kit, Envelope Feed Kit, RISO Printer Driver for Macintosh

## Appendix

---

Operating Noise	Max. 66 dB(A) (when printing 100 sheets per minute)
Power Source	SE9380A: AC 100-240 V, 50-60 Hz <5.0-2.2 A> SE9380E: AC 220-240 V, 50-60 Hz <2.2 A>
Power Consumption	Max. 400 W (100 V)/380 W (220 V) At Ready: approx. 52 W (100 V)/52 W (220 V) At Sleep: approx. 3.0 W (100 V)/4.0 W (220 V)
Functions	Idling, Print Speed Adjustment, Silent mode, Confidential mode, Auto-Process, Job Memory, Ink Saving, Layout, Binding Margin, Reservation, Output Reversal, Proof, Double Feed Check, User Management, Management of Consumables, Contrast Adjustment, Print Density Adjustment, Print Position Adjustment, Tone Curve, Jump Wing Control, Top Margin, Paper Size detection, Renew Page, Dot Process (4 types), Preview, Rotate, Scanning Side (with optional ADF DX-1), Admin. Mode, Interval Printing, Max. Scan, Special Paper Control, Auto 90° Rotation, Protect, Paper Size Selection, Overlay (with optional memory card or USB Flash Drive), Direct Print, Storage memory (with optional memory card), Scan Mode (with optional memory card or USB Flash Drive), My Direct Access, ID Counter Report, USB Job List (with USB Flash Drive), Custom Paper Entry, Programmed Printing (2 types), Direct Access Entry, Selections Entry, Book Shadow, RISO i Quality System, Scanning Contrast (Manual/Auto), Multi-Up Print (2 up/Single-Original/Multiple-Original/Multi-Up Tickets), ADF Semi-Auto (with optional ADF unit installed), Energy Saving Mode (Auto Sleep. Auto Power-OFF), ECO Mode
Dimensions	When in use: 1415 mm(W) × 705 mm(D) × 665 mm(H) (55 <sup>23</sup> / <sub>32</sub> "(W) × 27 <sup>3</sup> / <sub>4</sub> "(D) × 26 <sup>3</sup> / <sub>16</sub> "*(H)) When in storage: 780 mm(W) × 705 mm(D) × 665 mm(H) (30 <sup>23</sup> / <sub>32</sub> "(W) × 27 <sup>3</sup> / <sub>4</sub> "(D) × 26 <sup>3</sup> / <sub>16</sub> "*(H))
Required Space <sup>*1</sup>	1655 mm (W) x 1310 mm (D) x 1505 mm (H) (65 <sup>5</sup> / <sub>32</sub> " (W) x 51 <sup>9</sup> / <sub>16</sub> " (D) x 59 <sup>1</sup> / <sub>4</sub> " (H))
Weight <sup>*2</sup>	Approx. 115 kg (254 lb)
Safety Standards	IEC-60950-1 compliant, Indoor, pollution degree 2 <sup>*3</sup> , At altitudes of 2000 m or lower

### Note:

- Please note that due to improvements and changes to the machine, some images and explanations in this manual may not correspond to your machine.
- The specifications are subject to change without prior notice.

\*1 The height includes the height of the dedicated stand.

\*2 The weight does not include Ink and Master.

\*3 The pollution degree of the usage environment due to dirt and dust in the air. Degree "2" corresponds to general indoor environment.



# Index

## Symbols

* Key .....	24, 132
+ Key .....	24, 132
× Key .....	24, 132

## Numerics

2 Up .....	71, 75
------------	--------

## A

ADF Cover .....	23, 229, 230
ADF Original Guide .....	23
ADF Original Guides .....	23
ADF Original Receiving Tray .....	23
ADF Original Release Dial .....	228
ADF Original Release Lever .....	23, 228
ADF Semi-Auto .....	155, 168
ADF unit .....	23
Admin. ....	166
Admin. Screen .....	27
Advanced Features .....	114
Auto 90°Rotation .....	169
Auto Clear .....	170
Auto Document Feeder AF-VI:II .....	23, 256
Auto Document Feeder DX-1 .....	23, 256
Auto Idling .....	149, 171
Auto Page Renewal .....	150, 171
Auto Power-OFF .....	170
Auto Process Mode .....	168
Auto Sleep .....	170
Auto-control Stacking Tray .....	39, 40
Auto-Process .....	49, 66
Auto-Process Indicator .....	66
Auto-Process Key .....	25
Auto-process "OFF" .....	51, 57
Auto-process "ON" .....	57

## B

Base IP Address .....	169
Basic Screen .....	31
Beep Sound .....	172
Binding margin .....	88
Book Shadow .....	84

## C

C Key .....	24, 64, 132, 133, 155
Changing Administrator/User Registration .....	125
Changing Output Directions .....	55
Changing the Data Order .....	195
Changing the Owner Name .....	191
Check for Remaining Amount of Consumables .....	202
CI Select .....	168
Cleaning .....	216
Clear All .....	32, 55, 56
Clearing Programs .....	138
Clearing User Registration .....	126
Clock/Calendar .....	169

Closing the Auto-control Stacking Tray .....	40
Closing the Paper Feed Tray .....	36
Closing the Paper Receiving Tray .....	38
Color Drum (Cylinder) .....	256
Computer Connection .....	14
Confidential .....	147
Connection Method .....	14
Consumable Error .....	222, 225
Consumables .....	13, 202
Contrast Adj .....	68
Control Panel .....	24
Copying Stored Data .....	199
Counter .....	21
Create User .....	116, 171
Custom Paper .....	178
Custom Paper Entry .....	168, 178
Custom Paper Size .....	181

## D

Data Information .....	190
Data-Map .....	31
Default Folder .....	168
Default Settings .....	166, 173
Density (Print Density) .....	99
D-Feed Check .....	103
Direct Access .....	31, 176
Direct Print .....	48
DirectAccess Entry .....	166
Disable .....	124
Disabling User identification Access .....	124
Display .....	20, 24, 26, 32
Display Adjustment .....	167
Display Priority .....	166
Displayed Language .....	167
Disposal of Depleted Consumables .....	214
Document Storage Card .....	256
Dot Process .....	67
Double Feed Check .....	168
Duo .....	58
Duo (Line) .....	58
Duo (Photo) .....	58
Duo (Shadow off) .....	58

## E

ECO mode .....	170
E-mail .....	160
Energy Saving Mode .....	170
Enlargement/Reduction .....	63
Enlarging/Reducing Originals .....	61
Entering the User Name .....	122
Error Messages .....	222
Ex. Reserve Period .....	148, 169
Extended Paper .....	180
Extended Paper Mode .....	180
External CI Info .....	169



- F**
- Feed Tray Ascent / Descent Button ..... 20, 36
  - Feed Tray Paper Guide ..... 20
  - Flanges ..... 205
  - Folder Renaming ..... 168
  - Format ..... 192
  - Free ..... 63
  - Front Cover ..... 21
  - Function and Name of Each Part ..... 20
  - Functions Area ..... 31
  - Functions Screen ..... 27
- G**
- Gauge Cover ..... 41
  - Glass Platen ..... 41, 217
  - Group ..... 123, 129
- H**
- High Speed ..... 97
  - High/Full Management ..... 114, 115
  - Humidity Range ..... 12
- I**
- i Information ..... 31, 203
  - Icons Used in This Manual ..... 8
  - ID Counter Report ..... 160, 161
  - ID Print ..... 52
  - ID Print Job ..... 193
  - Idling Action ..... 149
  - Image ..... 58
  - Image Processing ..... 167
  - Image Processing Mode ..... 58
  - Initial Screen ..... 26
  - Ink ..... 207, 214
  - Ink Cartridge ..... 21, 207, 214
  - Ink Cartridge Cap Holder ..... 21, 208
  - Ink Handling ..... 13
  - Ink Information Input ..... 241
  - Ink Saving ..... 70
  - Installation ..... 10
  - Installation Error ..... 222, 226
  - Installation Location ..... 10
  - Interval ..... 104
  - Irregular Fitter ..... 168
- J**
- Jam Error ..... 222
  - Job ..... 32
  - Job list display ..... 167
  - Job List Screen ..... 52
  - Job Memory ..... 140, 141, 142, 144, 146
  - Job Operation Area ..... 32
  - Job Properties Area ..... 32
  - Job Separation ..... 168
  - Job Separator ..... 131, 256
  - Jump Wing Control ..... 105, 106, 168
- K**
- Key Card Counter ..... 256
- L**
- Layout ..... 80
  - Limit ..... 123
  - Line ..... 58
  - Location of Caution Label ..... 13
  - Low/Admin tab only ..... 114, 115
- M**
- Machine Handling ..... 12
  - Maintenance ..... 216
  - Maintenance Call ..... 232
  - Management Level ..... 114, 115, 119, 171
  - Margin+ ..... 61, 62
  - Margin-Plus Rate ..... 169
  - Margins ..... 19
  - Master ..... 215
  - Master core ..... 205, 214
  - Master Disposal Box ..... 20, 209
  - Master Disposal Box Handle ..... 209
  - Master Guide Flap ..... 21, 205
  - Master Information Input ..... 242
  - Master Jam Error ..... 223
  - Master Making Unit ..... 21, 204
  - Master Making Unit Cover ..... 21, 204
  - Master Making Unit Cover Lever ..... 204
  - Master Making Unit Handle ..... 21, 204
  - Master Making Unit Release Button ..... 21, 204
  - Master Replacement ..... 204
  - Master Roll ..... 21
  - Master Roll Holder ..... 21, 205
  - Master-Making Key ..... 25
  - Materials Not to Be Printed ..... 19
  - Max. Scan ..... 90
  - Message ..... 222
  - message area ..... 149
  - Meter Display ..... 163
  - Mid/ID Print Only ..... 114, 115
  - Minimum Print Q'ty ..... 171
  - MODE Key ..... 24
  - Monthly Reminder ..... 162
  - Moving Stored Data ..... 199
  - Multi-Page Mode ..... 130, 133, 134, 135
  - Multiple Paper Feed Detection ..... 103
  - Multiple-Original ..... 71
  - Multi-Up function ..... 71, 76
  - Multi-Up Interval ..... 74, 169
  - Multi-Up Print ..... 71, 76
  - Multi-Up Tickets ..... 74, 78
  - My Counter ..... 202
  - My Direct Access ..... 164
- N**
- Non-ID Print ..... 193

**O**

OP Auto Process .....	167
Operation Environment .....	12
Operation flow of User Management .....	116
Operation Safety Guide .....	12
Optional Accessories .....	256
Optional Device Area .....	32
Optional Device Error .....	222, 224
Orientation of Print Paper .....	74
Original .....	18
Original Margin .....	19
Output reversal .....	153
Overlay .....	197
owner name .....	190

**P**

P Key .....	24
Page Orientation .....	172
Paper .....	65
Paper Arranger .....	21, 37, 38, 39
Paper Document .....	43
Paper Ejection Adj .....	168
Paper Feed Adj. ....	105
Paper Feed Pressure Adjustment Lever .....	20, 36
Paper Feed Tray .....	20, 34, 36
Paper Guide .....	34
Paper Jam Error .....	223, 228
Paper Jumping Wing .....	21, 105
Paper Receiving Tray .....	21, 37, 38
Paper Recommendations .....	16
Paper Size .....	65
Paper Stopper .....	21, 37, 38, 39
Pause before "Master" .....	50, 57
Pause before "Print" .....	51, 57
Pencil .....	58
Pencil (Darker) .....	58
Pencil (Lighter) .....	58
Photo .....	58
Photo Contrast .....	68
Photo Gradation .....	69
Photo (Group) .....	58
Photo (Portrait) .....	58
Photo (Standard) .....	58
PIN Code .....	115, 117, 121, 173
PIN Code Input Screen .....	30, 46
Platen Cover Pad .....	217
Pop-Up Message .....	232
Power Connection .....	10
Power Switch .....	21, 34
Power-OFF Schedule .....	170
Pressure Roller .....	219
Preview .....	32, 55, 92
Print .....	160
Print Colors .....	172
Print Density .....	24, 99, 167
Print Density Adjustment Indicator .....	24, 99

Print Density Adjustment Keys .....	24, 99
Print Drum (Cylinder) .....	21, 211
Print Drum (Cylinder) Handle .....	21, 211
Print Drum (Cylinder) Release Button .....	21, 211
Print Drum (Cylinder) Replacement .....	211
Print Key .....	25
Print Paper .....	16, 36
Print Paper Handling .....	17
Print Paper Setting .....	34
Print Position Adjustment .....	100
Print Position Adjustment Keys .....	24
Print Quantity Display .....	24, 102
Print Quantity Keys (0 to 9 Keys) .....	24, 45
Print Speed .....	24, 96, 167
Print Speed Adjustment Indicator .....	24
Print Speed Adjustment Keys .....	24, 96
Print Speed Indicator .....	24, 96
Printer Exterior .....	220
Printing Cautions .....	19
Printing from Computer .....	32, 48
Printing from Paper Document .....	31, 43
Process .....	32
Program .....	129, 132
Progress Arrows .....	25
Proof .....	45, 102
Proof copy .....	45, 102
Proof Key .....	25, 102
Protect .....	171, 182
Push Out Lever .....	209

**R**

Receive Tray .....	112
Receiving Tray Paper Guides .....	21, 37, 38, 39
Receiving Tray Paper Guides' Opening Button .....	22
Recognition and Identification System .....	117
Recognition Screen .....	30, 46
Recognized by .....	115, 117, 121, 171, 173
Registering Administrator/Users .....	120
Reminder Date .....	160
Removing the Print Drum (Cylinder) .....	211
Rename .....	122
Rename Group .....	116, 127, 171
Rename Screen .....	136
Renew Page .....	32, 55, 150
Replacing Batteries .....	223, 232
Replacing Consumables .....	202
Reproduction Size .....	167
Reservation .....	148
Reserve Period .....	169
Reset All User Counters .....	128
Reset Counter .....	116, 128, 171
Reset Key .....	25
Retrieving a Program .....	137
Retrieving Stored Data .....	193
RISO Controller IS300 .....	256
RISO COPY COUNT VIEWER .....	15

RISO Print .....	28
RISO Printer Driver .....	15
RISO Stand D type (II) .....	256
RISO Stand N type (II) .....	256
RISO USB PRINT MANAGER .....	15
RISO Utility Software .....	15
Rotate .....	91

**S**

Safety Guide .....	10
Scan Mode .....	29
Scanner Glass .....	218
Scanning Contrast .....	60, 167
Scanning Side -ADF .....	156, 167
Selections Entry .....	176
Separation Hook .....	219, 231
Service Call Error .....	222, 223
Setting Data Information .....	190
Setting the Auto-control Stacking Tray .....	39
Setting the Group to assign .....	123
Setting the Management Level .....	119
Setting the Paper Receiving Tray .....	37
Setting Up the Monthly Reminder .....	162
Silent .....	98
Single Page Mode .....	129, 132
Size and Weight Restrictions .....	16, 18
Skip Page .....	32, 55
Software Installation .....	15
Special Paper Ctrl .....	105
Specifications .....	257
Speed (print speed) .....	96
Standard Ratio .....	61, 62
Start Key .....	25
Start-Up Screen .....	26
Status Area .....	31, 32
Stock Management .....	171
Stop Key .....	25
Stop Timing .....	49, 57
Storage Memory .....	193
Storing Environment .....	17
Storing Original Data .....	186
Sub Tool Bar .....	172

**T**

Tab Area .....	31, 32
Temperature Range .....	12
Text and Photo (Image Processing mode) .....	58
Text (Image Processing mode) .....	58
The Screens and their Various Stages .....	26
Thermal Print Head .....	217
Tips for Better Paper Feeding .....	17
Tone Curve .....	69
Tool Bar Position .....	172
Top Margin .....	87
Troubleshooting .....	222

**U**

Usage Status .....	163
USB Flash Drive .....	13, 115, 117, 121, 160, 173
USB Flash Drive Screen .....	30, 46
USB Job List .....	48, 53, 193
USB slot .....	21, 53
User Counter .....	128
User identification access .....	115, 124
User Management .....	114, 171
User Name .....	122
User Registration Number (ID) .....	120
User's Usage .....	123

**W**

WAKE-UP Key .....	25, 53
Warning Messages .....	233
White Sheet .....	218
Wide Stacking Tray .....	256

**Z**

Zoom .....	61, 64
------------	--------

