

Riso shall not be responsible for any damage or expense that might result from the use of this manual. As we are constantly improving our products, the machine may differ in some respects from the illustrations used in this manual. Riso shall not be liable for any direct, incidental, or consequential damages of any nature, or losses or expenses resulting from the use of this product or included manuals.

⚠ Caution:

- Make sure to read the important operational safety information.
- Store this manual close-by, and fully acquaint yourself with the printing machine.

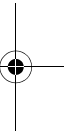
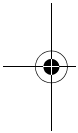

RISO is a registered trademark of RISO KAGAKU CORPORATION in Japan and other countries.

riso iQualitySystem™ is a trademark of RISO KAGAKU CORPORATION.

 is a trademark of RISO KAGAKU CORPORATION.

Adobe® Acrobat® Reader® and Adobe® Reader® are trademarks of Adobe Systems Incorporated.

- The information contained in this document is subject to change without notice.

Copyright © 2012 RISO KAGAKU CORPORATION

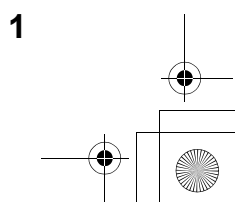
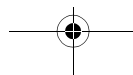
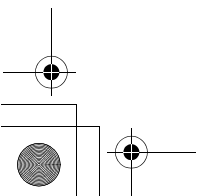

Contents

Welcome to the EZ5 Series Model	7
About The User's Guides	7
Icons Used in This Manual	8

Before Starting to Use **10**

Safety Guide - Installation	10
Installation	10
Power connection	10
Safety Guide - Handling and Operation.....	11
Operation Environment.....	11
Machine Handling.....	11
USB Flash Drive	12
Consumables.....	12
Ink Handling.....	12
Location of Caution Label.....	12
Connection with a Computer	13
Connection Method	13
Software Installation	14
Paper Recommendations	15
Size and Weight Restrictions.....	15
Tips for Better Paper Feeding	16
Storing Environment.....	16
Originals	17
Size and Weight Restrictions.....	17
Maximum Printing Areas and Margins.....	18
Materials Not to Be Printed	18

Getting Acquainted **20**

Function and Name of Each Part	20
Control Panel.....	22
Display.....	24
The Screens and their Various Stages.....	24
About Modes	26
Basic Screen Layout.....	29
Basic Process.....	31

Basic Operations 32

Preparing to Print.....	32
Setting up the Paper Feed Tray and Loading Paper	32
Setting up the Paper Receiving Tray	35
Placing the original	37
When placing on the Glass Platen	37
When placing in the ADF unit (Option)	37
Printing from a Paper Document or Book.....	39
Printing from a Computer Data [Direct Print] [USB Job List]	44
Printing Computer Data [Direct Print]	45
Printing USB Data [USB Job List].....	49
Changing Output Directions	52
Changing Stop Timing	54

Functions for Master-Making 56

Selecting Image Processing Mode [Image]	56
Selecting Scanning Contrast for the Original [Contrast]	58
Enlarging/Reducing Originals [Standard Ratio] [Margin+] [Free] [Zoom]	59
Enlargement and Reduction by Standard Ratio [Standard Ratio] [Margin+] [Auto].....	60
Enlargement/Reduction of a Changed Aspect Ration [Free].....	61
Enlarging and Reducing with the Zoom Function [Zoom]	62
Using Custom-Sized Paper [Paper].....	63
Automatic Printing [Auto-Process].....	64
Processing Photos with Dot Screen [Dot Process]	65
Adjusting Photo Contrast [Contrast Adj]	66
Adjusting Photo Gradation [Tone Curve].....	67
Saving Ink [Ink Saving]	68
Printing Multiple Originals on One Sheet [2 Up] [Multi-Up Print]	69
Original Orientation and Print Results	70
Margin.....	73
Orientation of Print Paper	73
Multi-Up Interval	73
2 Up Operation	74
Operation for Multi-Up Printing	76
Operation for Multi-Up Tickets.....	78
Printing from Bound Documents [Book Shadow]	81
Cutting the Top Margin of the Original and Printing [Top Margin]	83
Adjusting the Side Margins of the Master [Side Margin].....	85
Checking the Print Image Prior to Making Master [Preview]	87
Actions Available on the Preview Screen	88
Operation for Preview.....	88
Making a Master that Utilizes the Maximum Printing Area [Max. Scan]	90

Contents

Functions for Printing	92
Changing the Print Speed [Print Speed Adjustment].....	92
Adjusting the Print Density [Print Density Adjustment].....	93
Adjusting the Print Position [Print Position Adjustment]	94
Vertical (Up/Down) Adjustment	94
Horizontal (Left/Right) Adjustment.....	95
Printing Proof Copies [Proof].....	96
Extending the drying time [Interval].....	97
Paper Feed/Output Settings for Special Paper and Printing Types [Jump Wing Control] [Special Paper Ctrl].....	98
Setting the Jump Wing Control [Jump Wing Control]	99
Saving settings and Renaming the Parameter Names in the Parameter List	100
Retrieving Settings from the Parameter List.....	102
Making changes to Special Paper Ctrl Setting	103
Clearing Special Paper Ctrl Settings	104
 Advanced Features	 106
Setting Up User Management [User Management].....	106
Selecting Recognition and Identification System.....	109
Setting Up the Management Level	111
Registering Administrator/Users	112
Changing Administrator/User Registration	119
Clearing User Registration	120
Renaming Groups	121
Reset All User Counters	122
Automatic Sorting Into Groups [Program]	123
How to Program Print	125
Setting Up for Programed Printing	126
Saving Programs	128
Renaming a Program	129
Retrieving a Program.....	131
Clearing Programs	132
Making changes to Stored Programs	133
Using Job Memory Functions [Job Memory]	134
Storing Job Memory	135
Renaming a Job Memory	136
Retrieving a Job Memory and Printing	138
Clearing Job Memory	140
Protecting Confidential Documents [Confidential]	141
Extending the Reserve Period [Reservation]	142
Idling Action [Idling Action]	143
Reproducing the Master [Renew Page][Auto Page Renewal].....	144
Using Page Renewal	145
Using Auto Page Renewal.....	146
Proof and Print (with the ADF unit (Option) installed) [ADF Semi-Auto]	147
Showing Usage Status [Meter Display]	149
Rotating the Original 180 Degrees to Make a Master [Rotate].....	150

Checking User Counters [ID Counter Report]	151
Outputting the Counter Report	152
Setting Up the Monthly Reminder	153
Customizing the Direct Access Area [My Direct Access]	155
Changing Default Settings [Admin.]	157
Configurable Functions	157
Customizing the Default Settings	165
Setting Up Direct Access Area and Selections Tab [Direct Access Entry] [Selections Entry]	168
Registering a Custom Paper Size [Custom Paper Entry]	170
Entering sizes and changing names	170
Deleting a Custom Paper Size	172
Keeping Masters Secure After Printing [Protect]	173
Preventing Leaks of Masters After Creation or Disposal [Protect]	174
Storing Original Data and Use Method	176
Converting Hard-copies into Stored Data (Scan Mode)	178
Scanning an Original	178
Setting Data Information	180
Specifying Stored Size	182
Retrieving Stored Data and Printing [Storage Memory][USB Job List]	183
Retrieving Stored Data	183
Changing the Data Order	185
Using the Storage Retrieve Screen/USB Job List Retrieve Screen	186
Overlaying Stored Data onto a Print Job [Overlay]	187
Copying/Moving Stored Data	189
When using a Linked Printer	192
Print Functions for Using Linked Printers	192
Auto-Link Function	192
Link Mode Function	192
Setting up a Linked Printer [Link Properties]	193
Setting up a Linked Printer	193
Linked Printer Setup List	194
Printing Scanned Original from a Linked Printer [Link Mode]	197
Using Optional Functions on a Linked Printer	199
Configurable Functions	200
Duplex Printing [Duplex]	202
Using the Glass Platen or Auto Document Feeder AF-VI	202

Contents

Replacing Consumables 206

Check for Remaining Amount of Consumables..... 206
Replacing the Master Roll 208
Replacing the Ink Cartridge 211
Emptying the Master Disposal Box 213
Replacing the Print Drum (Cylinder) (Color (colour) Change)..... 215
 Removing the Print Drum (Cylinder)..... 215
 Installing the Print Drum (Cylinder)..... 217
Disposal of Depleted Consumables 218

Maintenance 220

Cleaning 220
 Thermal Print Head 221
 Glass Platen and Platen Cover Pad 221
 Scanner Glass and White Roller of ADF unit (Option) 222
 Pressure Roller 222
 The Exterior 223

Troubleshooting 224

When a Message Displays 224
 Error Message Layout 224
 Pop-Up Message Layout 232
 Consumable Information Screen 239
Troubleshooting..... 242

Appendix 250

Optional Accessories..... 250
Specifications 251
Index..... 254

Welcome to the EZ5 Series Model

Thank you for your purchase of this printing machine.

The EZ5 series is a digital duplicator with an LCD display. It features an easy-to-use Touch Screen which displays only the relevant buttons for any given task. With an interactive guidance system, highly-sophisticated printer settings can be made with ease.

About The User's Guides

This machine comes with the following four user's guides.

◆ **RISO EZ591/571/531 User's Guide (this manual)**

This user's guide explains basic printer operations, handy tips, and how to set up the high-speed print function. It also contains user cautions, information on storing and changing consumables, and troubleshooting procedures. It also contains an explanation for using "Link Mode" when an optional linked printer is attached.

◆ **RISO Editor User's Guide**

This user's guide explains the RISO Editor functions.

◆ **RISO Printer Driver User's Guide (included as a PDF file in the attached CD-ROM)**

This user's guide explains the procedures for printing from a computer.

◆ **RISO Utility Software User's Guide (included as a PDF file in the attached CD-ROM)**







This user's guide explains how to use the software of the "RISO USB PRINT MANAGER" and "RISO COPY COUNT VIEWER".

Icons Used in This Manual

The following icons are used in this manual.

About the notation

The following icons are used throughout the document.

-  **WARNING:** Ignoring this warning could cause death or serious injury.
-  **Caution:** Ignoring this caution could cause injury or damage to property.
- Important!:** Indicates items that require special attention or that are prohibited actions. Read carefully and follow the directions as instructed.
- Note:** Gives you useful information.
- Tip:** Gives you additional hints for more convenience.
-  Indicates a reference page.
-  Indicates a button or item name on the LCD display.
-  Indicates which button to touch on the LCD display.
-  Indicates the original document.
-  Indicates printed copies.

The notation for Operational Instructions and Function Descriptions

The following conventions are used to explain functions and operations.

1

2

3

Functions for Master-Making

Selecting Image Processing Mode [Image]

In order to make a master best suited for the original document, select an appropriate mode depending on what the original contains (text [Line], photo, or both of them).

Note:

- Default Image Processing mode can be set on the Admin. screen. → p.159

1 Touch [Image] on the Master Making Basic Screen.



2 Select the appropriate Image Processing mode for the original.



- [Line]:** Only text contained; e.g., text document, newspaper
- [Photo]:** Only photos contained
- [Duo]:** Both text and photos contained
- [Pencil]:** Pencil drawings or lightly printed documents

Functions for Master-Making

3 Touch [Photo], [Duo] or [Pencil] to detailed settings.

Image (Detailed settings)	Description
[Photo]	
Standard	Select for photos other than (Group)
Portrait	Use this setting for pictures two individuals from the bust type of image processing is good for printing photos of
Group	This setting is for group photo over-exposed. This process for restoring facial features become washed out by a fit. The Group setting is not for faces that are overly dark. It more effective to select [Bk] such photos.
[Duo]	
Line	Select to print small text clear
Photo	Select to print photos more brightly.
Shadow off	Select to clear the background (color) of the dark-color originals (such as newspaper) (Shadow off) is selectable [Line] and [Photo]
[Pencil]	
Darker	Select to print faint original
Lighter	Select to print cut-and-past drawings with shadows.

Touch [Photo], [Duo] or [Pencil] to detailed settings.

3 Touch [OK].
Returns to the Master Making Basic Screen. Image Processing mode is updated.

Note:

- Some functions are not available in certain Image Processing mode settings.

	Line	Photo	Duo	Pencil
Dot Process	—	✓	✓	—
Contrast (Auto)	✓	—	—	—
Contrast (1-5)	✓	✓	—	✓
Contrast Adj	—	✓	—	—
Tone Curve	—	—	✓	✓

✓ available — not available

- In the [Line] mode, when [Contrast] is set to [Auto], the background color (colour) of the original is automatically deleted. → p.58

1) Chapter Title

2) Operation Procedure

The operational procedures are outlined in steps. Follow these steps.

3) Display

Shows the screen as seen on each step.

About the content of this manual and the illustrations

- The illustrations included in this document depict the EZ571A model in most cases.
- Displays are illustrated as if currently activated. Some buttons presented in this manual may not be available by default setting, or when the optional device is not installed.
- The optional Auto Document Feeder AF-VI is referred to as the "ADF unit (Option)".
- The optional Document Storage Card DM-128CF and Document Storage Card DM-512CF are collectively described as the "Document Storage Card".

Icons Used in This Manual 9

Before Starting to Use

Safety Guide - Installation

This section describes the precautions to be observed when installing the machine. Read this section before installing the machine.

Note:

- Your dealer (or authorized service representative) will help you to determine a proper location for the machine at the time of delivery.

Installation

⚠ WARNING:

- Place the machine on the dedicated stand for this model or on a flat and stable surface (maximum of 10 mm ($\frac{3}{8}$ inches) differential allowed). Injury might occur if the machine falls.
- Install the machine in a well-ventilated area. Failure to do so may result in serious health problems.

⚠ Caution:

- Install the machine near the electrical outlet to avoid using an extension cord between the machine and the electrical outlet. If an extension cord is absolutely required, do not use one longer than 5 m (15 feet).
- Allow at least 10 cm (4 inches) or more of clearance behind the machine so that you can unplug the machine in case of technical difficulties.
- Keep the machine away from dusty environments. Failure to do so may result in fire.

Important!:

- Avoid installing the machine in the locations listed below. Failure to observe this precaution may lead to machine failure.
 - Locations with exposure to direct sunlight, such as locations close to windows (Curtain all windows that might expose the machine to direct sunlight)
 - Locations that are subject to sudden changes in temperature
 - Extremely hot and humid locations or cold and dry locations
 - Heated locations
 - Locations exposed to direct cold air, direct hot air, or direct radiant heat
 - Locations of poor permeability and ventilation

Power connection

⚠ WARNING:

- Do not overload the electrical outlet or extension cord, nor damage the power cord by placing heavy objects on it or pulling or bending it. This can result in fire or electric shock.
- Do not pull the power cord but hold the plug itself when unplugging it. This can damage the cord and result in fire or electric shock.
- Do not plug or unplug the power cord if your hands are wet. This can result in electric shock.

⚠ Caution:

- Pull out the power cord plug from the electrical outlet more than once a year and clean the prongs of the plug and their surroundings. Dust collected on these areas can result in fire.

Important!:

- Check the power cord and plug for poor connections. Plug the power cord securely into a nearby electrical outlet.
- Be sure to turn off the POWER switch when connecting or disconnecting a cable.
- Do not touch the POWER switch on the upper part of the AC inlet (power cord connection). Changing the POWER switch setting by mistake will cause damage.

Safety Guide - Handling and Operation

This section describes the precautions to be observed when handling the machine. Read this section before operating the machine.

Operation Environment

Important!:

- Operate the machine under the following appropriate environment conditions.
Temperature range: 15°C to 30°C (59°F to 86°F)
Humidity range: 40% to 70% (noncondensing)

Machine Handling

⚠ WARNING:

- Do not place water containers or metallic objects on the machine. Fire or electric shock may occur if water or metallic objects fall into the machine.
- Do not use combustible spray and flammable solvent near the machine.
If sprayed gas and flammable solvent contact electronic components inside the machine, fire or electric shock might occur.
- Do not insert any metallic material or flammable substance into the machine through any opening. This can result in fire or electric shock.
- Do not remove machine covers. Exposing internal parts may result in electric shock.
- Do not disassemble or rebuild the machine by yourself. This can result in fire or electric shock.
- If the machine emits excessive heat, smoke or foul odor, immediately turn off the POWER, unplug the power cord and contact your service representative. Failure to do so can result in fire or electric shock.
- If something drops inside the machine, immediately turn off the POWER, unplug the power cord and contact your service representative. Failure to do so can result in fire or electric shock.
- Never stick your hands or fingers in the openings of the machine during operation.
- Keep loose clothing or long hair away from moving parts to avoid becoming entangled.
- Do not place heavy objects on the machine. The objects might fall and cause injury.
- Contact your service representative before moving the machine.

⚠ Caution:

- Never insert fingers, etc. into the openings around Paper Feed Tray and Paper Receiving Tray. This can result in injury.
- Because ink may have stuck to areas around the Print Drum (Cylinder) or inside the machine when the Print Drum (Cylinder) was removed, be careful not to contact them with your hands or clothes.
When ink has stuck to your hands, etc., wash it off with detergent as soon as possible.
- When you remove paper by inserting a hand inside the machine, be careful not to touch the paper separation hook. Because the tip of paper separation hook is sharp, it might cause injury.
- Do not open any covers or move the machine during operation.
- Unplug the power cord, if you do not use the machine for a long time.
- The machine has precision parts and driving parts inside. Do not handle the machine in other ways than described in this manual.
- Do not apply any shock to the machine.
- Do not stand the Print Drum (Cylinder) vertically. Doing so may pollute the floor, etc.

Important!:

- Do not unplug the power cord or turn off the power during operation.
- Be sure to open and close all machine covers gently.

Before Starting to Use

USB Flash Drive

Important!:

- Use a USB Flash Drive to store large volumes of data. Depending on the types of USB Flash Drive, the machine does not work properly.
- When connecting or disconnecting the USB Flash Drive, follow the proper procedures.
- We cannot guarantee data saved in the USB Flash Drive against loss caused by accidents or unforeseen events. We recommend that you use your computer to make back-up copies of any important documents.

Consumables

Important!:

- For ink and Master Roll, it is recommended to use the products specified by RISO.
- Store consumables such as Master Roll and ink properly.
Do not store consumables in the following places:
 - Locations that are subject to direct sunlight or bright locations that are close to windows (If there is no other choice, curtain the window.)
 - Locations that are subject to rapid changes in temperature
 - Extremely hot and humid locations or extremely cold and dry locations

Ink Handling

⚠ Caution:

- If ink gets into your eyes, flush it out immediately with plenty of water. If irritation continues, seek medical attention.
- If ink comes into contact with your skin, wash it off thoroughly using soap.
- Allow plenty of ventilation during printing.
- If you feel unwell during use, seek medical advice.
- Only use the ink for printing purposes.
- Keep the ink out of the reach of children.

Location of ⚠ Caution Label

This machine has a ⚠ caution label meant to ensure safe operation. Follow the indication of the label and use the machine safely.

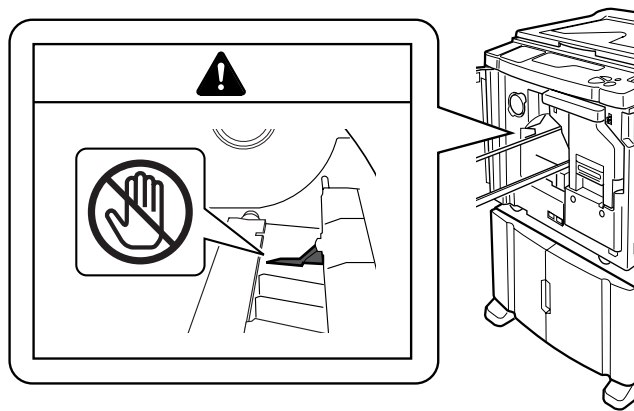

Connection with a Computer

You can directly send data from a connected computer to the machine as an original for printing. Because digital data itself is used for making a master, the finish of prints becomes outstanding.

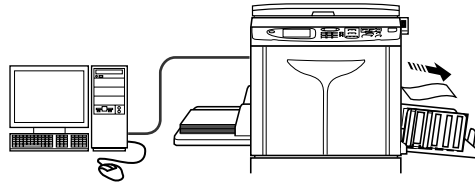

Connection Method

◆ One-to-one connection with a Windows PC

- Cable:
USB cable
3m (10 feet) Hi-Speed USB

Important!:

- Before making the USB connections, turn on both the machine and computer, and wait until the initial screen is displayed.
- The maximum allowable voltage for USB connector input and output is 5 V.
- For the USB connections, use a commercially available USB cable (that conforms to the USB 2.0 standard).

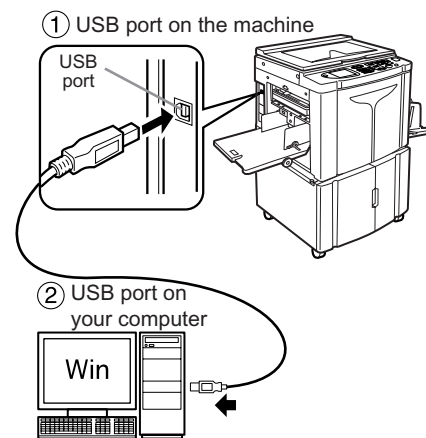

◆ Network connections

- Cable:
Ethernet cable
Shielded cable that supports 10BASE-T or 100BASE-TX

Important!:

- Before making the Ethernet connections, turn off both the machine and computer.

Note:

- The RISO Network Card (Option) is required.
- If the optional network interface card "RISO Network Card" is installed, the machine can be connected with a Macintosh computer. For details, see the User's Guide of RISO Network Card.

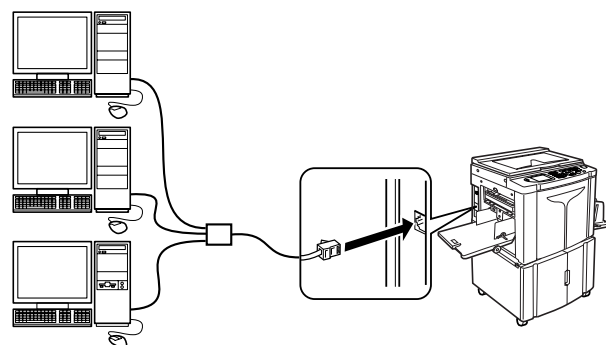

Before Starting to Use

Software Installation

Before printing from a computer connected to the machine via a USB cable, the RISO printer driver must be installed. Before printing from a computer connected to the machine via a network, both the RISO printer driver and RISO Network Card must be installed. Refer to the Printer Driver User's Guide and RISO Network Card User's Guide for instructions on installation.

Note:

- RISO Network Card is an option.
The software supplied with this machine is as follows:

◆ RISO Printer Driver

RISO Printer Drivers are for use with RISO Printers only.
Before setup, be sure to read the User's Guide carefully.
The User's Guide can be found as a PDF file* in the CD-ROM which came with the RISO Printer.

*To be able to view PDF format files, it is necessary for either Adobe® Reader® or Adobe® Acrobat® Reader® to be installed.

Adobe® Reader® or Adobe® Acrobat® Reader® software can be freely downloaded from the Adobe website (<http://www.adobe.com/>).

◆ RISO Utility Software

The software package includes the "RISO USB PRINT MANAGER" and "RISO COPY COUNT VIEWER".

- "RISO USB PRINT MANAGER"
Application that manages the original data stored in the USB Flash Drive on the computer.
- "RISO COPY COUNT VIEWER"
Application that manages the counter data (number of prints, masters, etc.) output to the USB Flash Drive on the computer.

Paper Recommendations

Size and Weight Restrictions

The table shows the specifications of the usable print paper.

Usable Printing Paper	
Size	Weight
100 mm × 148 mm (3 ¹⁵ / ₁₆ " × 5 ²⁷ / ₃₂ ") to 310 mm × 432* mm (12 ³ / ₁₆ " × 17")	46 g/m ² (12-lb bond) to 210 g/m ² (110-lb index)

*The machine can print (feed) paper up to 555 mm (21²⁷/₃₂") long by setting the "Custom Paper Entry". [p.170](#), [p.171](#)

Important!:

- Even when using paper whose sizes and weight are supported by the machine, it may not pass through the machine depending on such factors as the paper quality, ambient conditions, and storage conditions. For more information, consult your dealer (or authorized service representative).

Do not use the following types of paper, as they can cause jams or misfeeds:

- Extremely thin paper (less than 46 g/m² (12-lb bond))
- Extremely thick or heavy paper (greater than 210 g/m² (110-lb index))
- Wrinkled, curled, folded, or torn paper
- Chemically treated or coated paper (such as thermal or carbon paper)
- Paper having a sticky section or holes (such as an envelope and label paper)

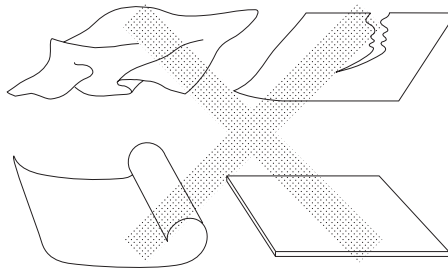

Note:

- Paper with a horizontal grain direction can cause problems with paper supply. Use paper with a vertical grain direction.
- Images are not output onto the entire area of usable print paper. The maximum printing areas differ among models. [p.18](#)
- When using poorly cut paper or coarse surfaced paper (drawing paper, etc.), arrange the paper neatly before use.
- Depending on the type of paper used, paper dust may be generated when using the machine. Please clean and ventilate the area adequately.

RISO does not assure that paper outside the above specifications pass through the machine and can be used for printing.

Before Starting to Use

Tips for Better Paper Feeding

To prevent paper jams and misfeeds, follow the directions below:

- When using standard or light-weight paper, set the Paper Feed Pressure Adjustment Lever to “NORMAL” (✕). Then open all four Paper Arrangers. [p.33](#), [p.35](#)
- When using thick paper (such as card stock), set the Paper Feed Pressure Adjustment Lever to “CARD” (⊗), and open the two inner Paper Arrangers. [p.33](#), [p.35](#)
- When using slippery paper, set the Paper Feed Pressure Adjustment Lever to “CARD” (⊗). [p.33](#)
- Slide the Feed Tray Paper Guides, Receiving Tray Paper Guides, and Paper Stopper to fit the paper size. [p.32](#), [p.35](#)
- Use flat printing paper that is free of folds. If curled paper is unavoidable, place the printing paper so that the inner curled part faces down.
- Paper may stick to the drum (cylinder) surface if the top margin is too narrow on the original or if the upper portion of the original uses a large amount of ink. To solve this problem, lower the print position to provide a wider top margin or reverse the top and bottom of the original. Then restart printing from the beginning.

Storing Environment

Store printing paper in a level, dry area. Storing the paper in an excessively humid area can result in paper jams or poor print quality.

After unpacking printing paper, keep the remaining paper wrapped and store it in a moisture-proof box. It is highly recommended to put silica gel in the paper storage box.

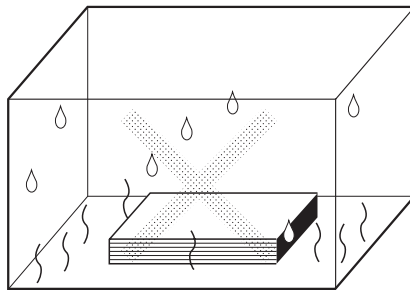

Originals

Size and Weight Restrictions

Usable originals are as follows.

Using the Glass Platen		Using the ADF unit (Option)	
Size	Weight	Size	Weight
50 mm × 90 mm (1 ³¹ / ₃₂ " × 3 ⁹ / ₁₆ " to 310 mm × 432 mm (12 ³ / ₁₆ " × 17")	Max. 10kg (22 lb)	100 mm × 148 mm (3 ¹⁵ / ₁₆ " × 5 ²⁷ / ₃₂ " to 310 mm × 432 mm (12 ³ / ₁₆ " × 17")	50 g/m ² (13-lb bond) to 128 g/m ² (34-lb bond)

- Originals are scanned according to the size of paper placed on the Paper Feed Tray when masters are made; for the same width, the positions of the Feed Tray Paper Guides.
When the placed paper is smaller than an original, not the entire original will be scanned.
When the placed paper is larger than an original, dirt on the glass or shade of the original, for example, may result in unexpected dirt in the area beyond the size of the original.
- Bound originals can also be used on the Glass Platen.
- You can feed automatically up to 50 original sheets when using the ADF unit (Option).
(When originals of 80 g/m² (21-lb bond) or less are used)

Note:

- Use the Glass Platen when printing the following originals:
 - Patched or worn originals
 - Wrinkled, curled, folded, or torn originals
 - Transparent originals (such as tracing paper or OHP transparencies)
 - Chemically treated originals (such as thermal or carbon paper)
 - Originals with correction fluid or glue
 - Extremely thin originals (less than 50 g/m² (13-lb bond))
 - Extremely thick originals (greater than 128 g/m² (34-lb bond))
 - Heavy drawing paper
 - Originals with staples or clips
- If an original wrinkled, curled, or creased flatten it thoroughly so that the original can be pressed directly onto the Glass Platen during processing.
- If correction fluid or glue is used on an original, thoroughly dry it before placement.
- For an original patched with thick paper, the shade of the patched paper may also be printed.

Before Starting to Use

Maximum Printing Areas and Margins

The maximum printing areas are as follows.

Model	Maximum Printing Area	Usable Maximum Print Paper Size
EZ591	291 mm × 425 mm (11 ⁷ / ₁₆ " × 16 ³ / ₄ ")	310 mm × 432 mm (12 ³ / ₁₆ " × 17")
EZ571	291 mm × 413 mm (11 ⁷ / ₁₆ " × 16 ¹ / ₄ ")	
EZ531	251 mm × 357 mm (9 ⁷ / ₈ " × 14 ¹ / ₁₆ ")	

Important!:

- No matter which size of originals is printed, the margins indicated on the figure are required for the originals. Reduce the original if necessary to fit it inside of the margins. Place an original so that its end having a 5 mm (³/₁₆") margin at least comes to the left of the Glass Platen or the ADF unit (Option).

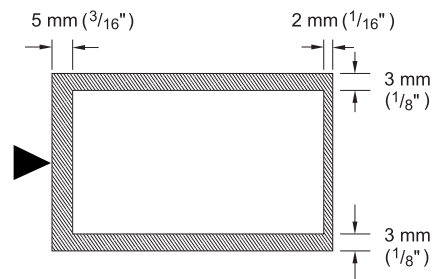

Materials Not to Be Printed

Do not use the machine in any manner which violates the law or infringes on established copyrights, even when making copies for personal use. Consult your local authorities for further details. In general, use discretion and common sense.

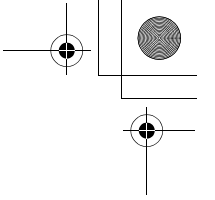

Before Starting to Use

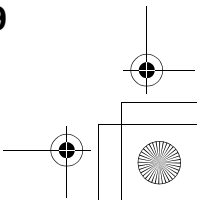
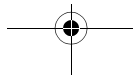
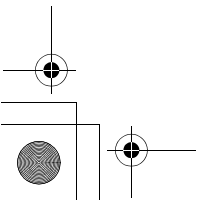
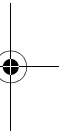
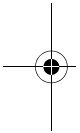

Getting Acquainted

Function and Name of Each Part

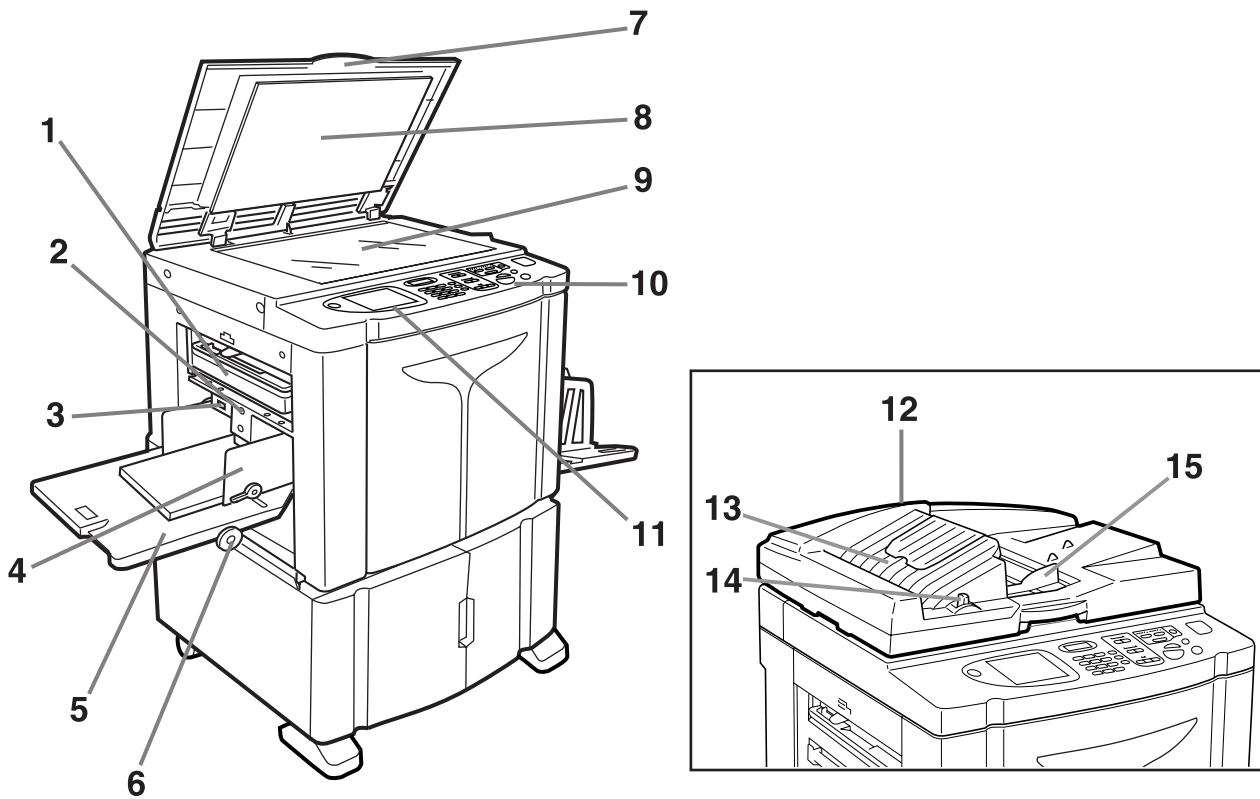

- | | |
|----------------------------------------------------------------------------------------------------------------------------------------------------------------------------------------------------------------------------------------------------------------------------------------------------------------------------------------------------------------------------------------------------------------------------------------------------------------------------------------------------------------------------------------------------------------------------------------------------------------------------------------------------------------------------------------------------------------------------------------------|---------------------------------------------------------------------------------------------------------------------------------------------------------------------------------------------------------------------------------------------------------------------------------------------------------------------------------------------------------------------------------------------------------------------------------------------------------------------------------------------------------------------------------------------------------------------------------------------------------------------------------------------------------------------------------------------------------------------------------------------------------------------------------------------------------------------------------------------------------------------------------------------------------------------------|
| <p>1) Master Disposal Box (☞p.213)
Holds discarded masters.</p> <p>2) Feed Tray Ascent/Descent Button (☞p.34)
Lowers or raises the Paper Feed Tray when changing or adding paper.</p> <p>3) Paper Feed Pressure Adjustment Lever (☞p.33)
Adjusts the paper feed pressure according to paper in use.</p> <p>4) Feed Tray Paper Guides (☞p.32)
Holds and guides paper.
Slide to fit to the sides of paper.</p> <p>5) Paper Feed Tray (☞p.32)
Load print paper on this tray.</p> <p>6) Horizontal Print Position Adjustment Dial (☞p.95)
Move the print position to the left or right.</p> <p>7) Platen Cover
Opened and closed when placing the original.</p> | <p>8) Platen Cover Pad (☞p.221)</p> <p>9) Glass Platen (☞p.40, ☞p.221)
Place the original face-down.</p> <p>10) Control Panel (☞p.22, ☞p.23)
Press the keys to perform various print operations.</p> <p>11) Display (☞p.24 ~ p.30)
Displays various screens needed for print operations. Touch the buttons on the screen to execute various print operations.</p> <p>12) Auto Document Feeder (Option)
The Feeder can hold approximately 50 sheets of the original sheets (80 g/m² (21-lb bond)). Place the original face-down.</p> <p>13) ADF Original Receiving Tray
Scanned originals are ejected into this tray.</p> <p>14) ADF Original Release Lever
If an original is jammed, press to eject from the ADF unit.</p> <p>15) ADF Original Guide
Slides and adjusts to the width of the original to hold together.</p> |
|----------------------------------------------------------------------------------------------------------------------------------------------------------------------------------------------------------------------------------------------------------------------------------------------------------------------------------------------------------------------------------------------------------------------------------------------------------------------------------------------------------------------------------------------------------------------------------------------------------------------------------------------------------------------------------------------------------------------------------------------|---------------------------------------------------------------------------------------------------------------------------------------------------------------------------------------------------------------------------------------------------------------------------------------------------------------------------------------------------------------------------------------------------------------------------------------------------------------------------------------------------------------------------------------------------------------------------------------------------------------------------------------------------------------------------------------------------------------------------------------------------------------------------------------------------------------------------------------------------------------------------------------------------------------------------|

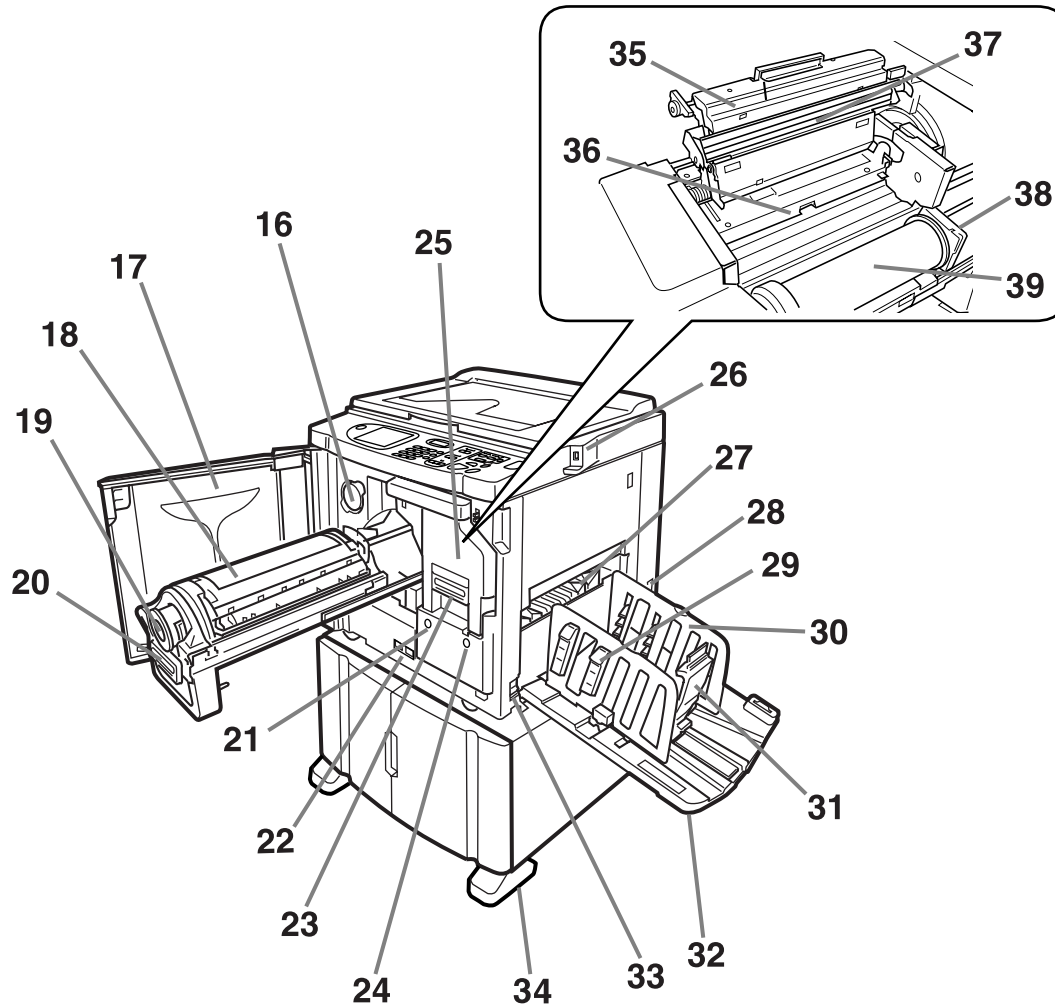

- | | |
|------------------------------------------------------------------------------------------------------------------------------------------------------------------------------------------------------------------------------------------------------------------------------------------------------------------------------------------------------------------------------------------------------------------------------------------------------------------------------------------------------------------------------------------------------------------------------------------------------------------------------------------------------------------------------------------------------------------------------------------------------------------------------------------------------------------------------------------------------------------------------------------------------------------|----------------------------------------------------------------------------------------------------------------------------------------------------------------------------------------------------------------------------------------------------------------------------------------------------------------------------------------------------------------------------------------------------------------------------------------------------------------------------------------------------------------------------------------------------------------------------------------------------------------------------------------------------------------------------------------------------------------------------------------------------------------------------------------------------------------------------------------------------------------------------------------------------------------------------------------------------------------|
| <p>16) Ink Cartridge Cap Holder (p.212)
Secure the Ink Cartridge cap.</p> <p>17) Front Cover</p> <p>18) Print Drum (Cylinder) (p.215)</p> <p>19) Ink Cartridge (p.211)</p> <p>20) Print Drum (Cylinder) Handle (p.215)</p> <p>21) Print Drum (Cylinder) Release Button (p.215)
Unlocks the Print Drum (Cylinder) for removal.</p> <p>22) Counter
Counts the number of copies (total print counter) and the number of made masters (master counter).</p> <p>23) Master Making Unit Handle (p.208)</p> <p>24) Master Making Unit Release Button (p.208)
Unlocks the Master Making Unit for removal.</p> <p>25) Master Making Unit (p.208)</p> <p>26) USB Slot (p.43)
Connect the USB Flash Drive.</p> <p>27) Paper Jumping Wing (p.98)
Automatically adjusts to keep printed paper neatly stacked.</p> | <p>28) AC inlet
Do not touch the POWER switch on the upper part of the AC inlet (power cord connection). Changing the POWER switch setting by mistake will cause damage.</p> <p>29) Paper Arranger (p.35)
Press to open for aligning printed paper.</p> <p>30) Receiving Tray Paper Guides (p.35)
Aligns printed paper neatly.
Slide according to the width of print paper size.</p> <p>31) Paper Stopper (p.35)
Slide to adjust to the length of print paper size.</p> <p>32) Paper Receiving Tray (p.35)
Printed copies are output to this tray.</p> <p>33) Power Switch (p.32)</p> <p>34) Stabilizer</p> <p>35) Master Making Unit Cover (p.208)
Open and close to install Master Roll.</p> <p>36) Master Guide Flap (p.209)</p> <p>37) Thermal Print Head (p.221)</p> <p>38) Master Roll Holder (p.209)</p> <p>39) Master Roll (p.208)</p> |
|------------------------------------------------------------------------------------------------------------------------------------------------------------------------------------------------------------------------------------------------------------------------------------------------------------------------------------------------------------------------------------------------------------------------------------------------------------------------------------------------------------------------------------------------------------------------------------------------------------------------------------------------------------------------------------------------------------------------------------------------------------------------------------------------------------------------------------------------------------------------------------------------------------------|----------------------------------------------------------------------------------------------------------------------------------------------------------------------------------------------------------------------------------------------------------------------------------------------------------------------------------------------------------------------------------------------------------------------------------------------------------------------------------------------------------------------------------------------------------------------------------------------------------------------------------------------------------------------------------------------------------------------------------------------------------------------------------------------------------------------------------------------------------------------------------------------------------------------------------------------------------------|

Getting Acquainted

Control Panel

The Control Panel features permanent keys such as  and . It also has a large-size display that shows various messages and function buttons.

This section introduces hardware Key names and functions, as well as the display window and its functions.

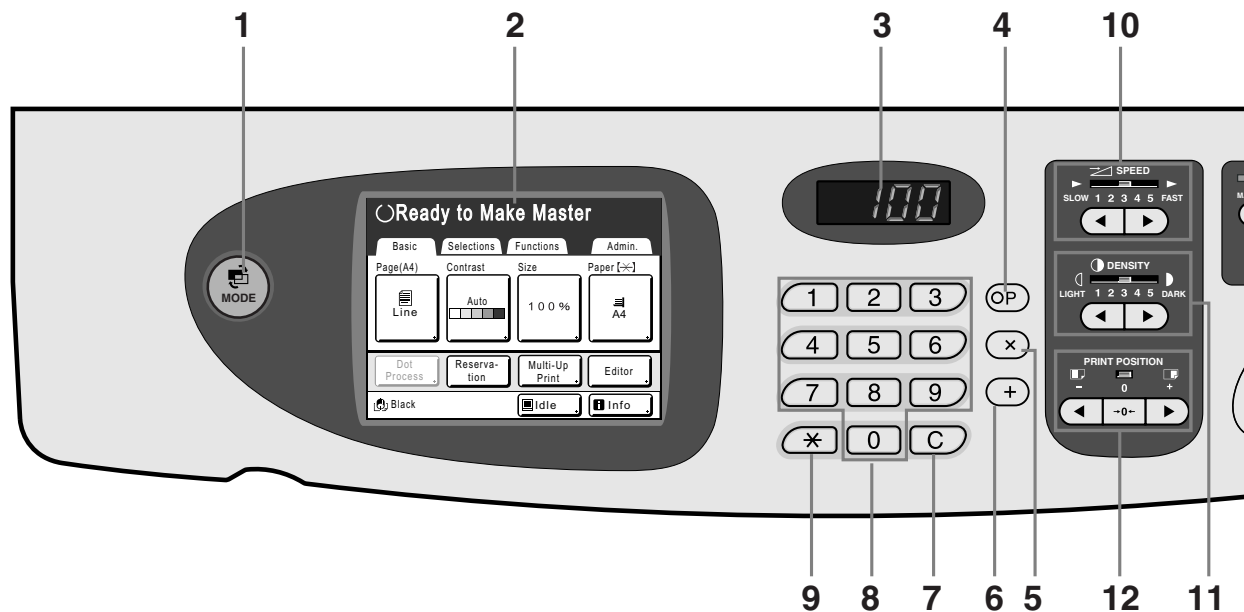

- 1) **MODE Key** (☞ p.24)
Use to change modes.
- 2) **Display** (☞ p.24 ~ p.30)
- 3) **Print Quantity Display**
Displays the number of copies, or numeric values entered for various settings.
- 4) **P Key** (☞ p.126)
Use to retrieve stored programs. The indicator on the key lights when set.
- 5) **× Key** (☞ p.126)
Use to move between fields in setup screens, or set up programmed printing.
- 6) **+ Key** (☞ p.126)
Use to move between fields in setup screens, or set up programmed printing.
- 7) **C Key**
Cancels entered numerical values, or reset the counter to 0.
- 8) **Print Quantity Keys (0 to 9 Keys)**
Use to enter the number of copies, or the numerical values for various settings.
- 9) **✕ Key** (☞ p.126, ☞ p.134)
Use to move between fields in setup screens, or retrieve stored memory.
- 10) **Print Speed Adjustment Keys/Indicator** (☞ p.92)
Selects the print speed from five levels.
The indicator above the keys shows the current speed level.
- 11) **Print Density Adjustment Keys/Indicator** (☞ p.93)
Selects the print density from five levels.
The indicator above the keys shows the current density level.
- 12) **Vertical Print Position Adjustment Keys/Indicator** (☞ p.94)
Adjusts the print position in the vertical direction (within ± 15 mm ($\pm 19/32$ ")) after making a master.
The indicator above the keys shows the offset amount from the center.
To clear the offset amount, press .

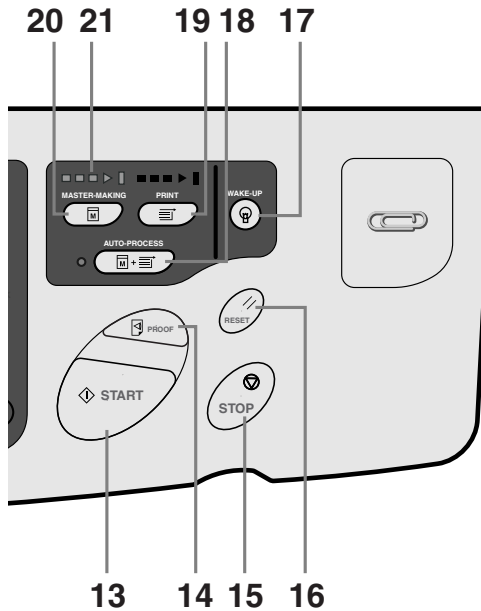

13) Start Key

Starts master-making or printing process or executes specified operations.
The key is lighted only when the key is active.

14) Proof Key (p.96)

Use to check print result after adjusting the print position, for example.
This allows you to print proof copies without affecting the value on the Print Quantity Display.

15) Stop Key

Stops current operation in progress. During the master-making procedure, the machine will not stop until the master-making process is completed.

16) Reset Key

Returns all settings to the initial settings.

17) WAKE-UP Key / Log out Key (p.39, p.45, p.49)

Wakes up the printer in Energy Saving mode.
Use this key also to log out from the machine.

18) Auto-Process Key (p.64)

Performs non-stop operation from master-making through printing. When activated, the indicator besides the key lights.

19) Print Key

Makes the printer be ready for printing.

20) Master-Making Key

Makes the printer be ready for making masters.

21) Progress Arrows

Indicates master-making and printing progress status.

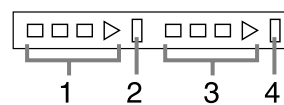

- 1) Master-Making Indicator
- 2) Master-Making Stop Bar
- 3) Print Indicator
- 4) Printing Stop Bar

Ready to make a master (Auto ON): when 1 is blinking
Ready to make a master: when 1, 2 are blinking
Ready to print: when 3, 4 are blinking
The indicator increases one bar at a time from the left, indicating the progress of the current master-making or printing job.

- If a master-making or printing job is halted, the progress bar stays lit at that position. (Ready for resume)

Getting Acquainted



Display

The Screens and their Various Stages

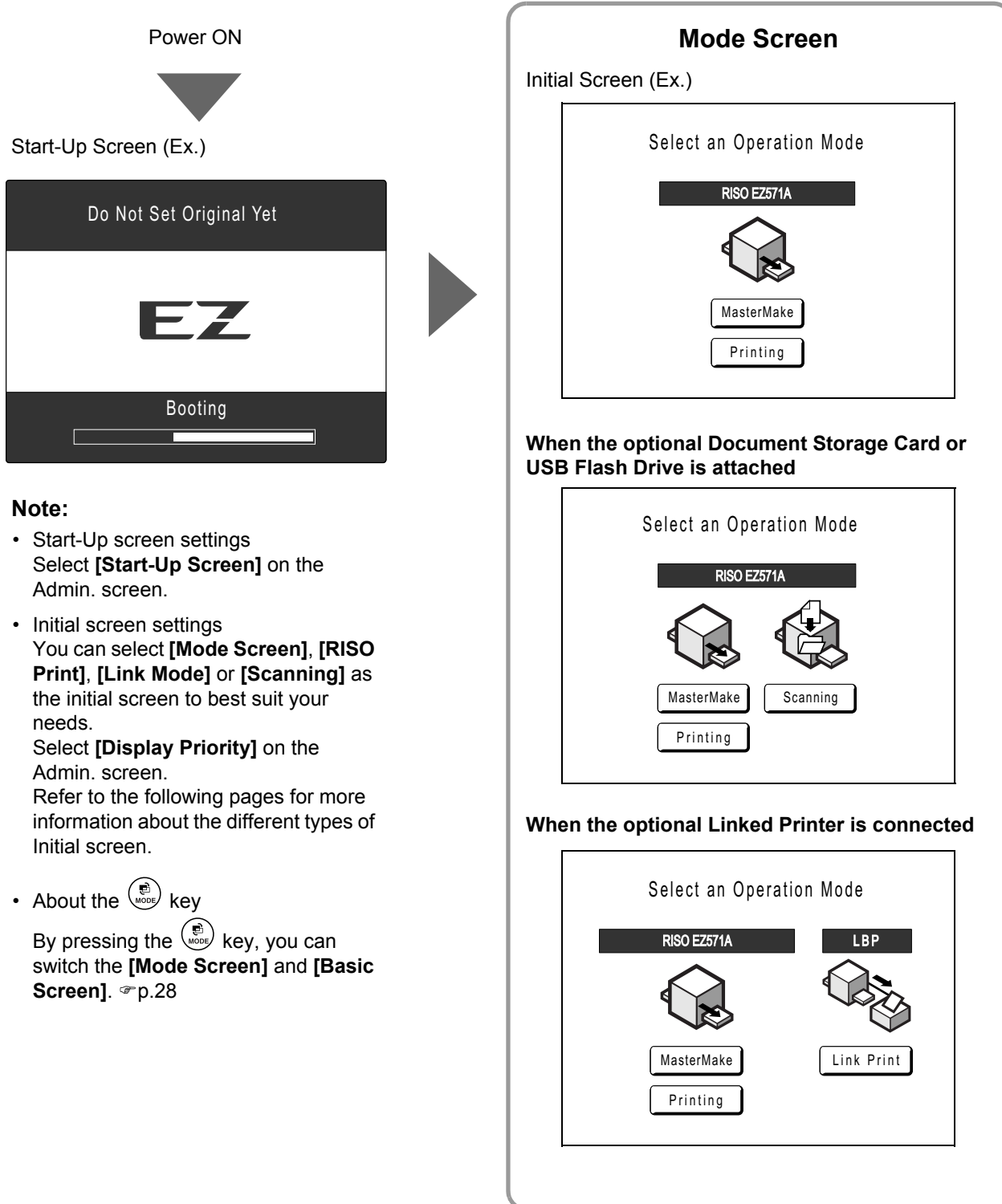
When the power is turned on, after a brief display of the start-up screen, the initial screen appears.



Note:

- Start-Up screen settings
Select [**Start-Up Screen**] on the Admin. screen.
- Initial screen settings
You can select [**Mode Screen**], [**RISO Print**], [**Link Mode**] or [**Scanning**] as the initial screen to best suit your needs.
Select [**Display Priority**] on the Admin. screen.
Refer to the following pages for more information about the different types of Initial screen.
- About the  key
By pressing the  key, you can switch the [**Mode Screen**] and [**Basic Screen**]. [p.28](#)

Basic Screen

- Touch **[MasterMake]** to display the Master Making Basic Screen.

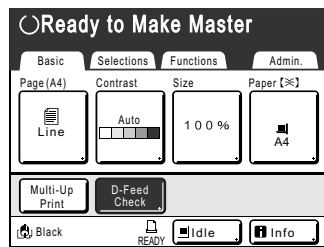

- Touch **[Printing]** to display the Print Basic Screen.

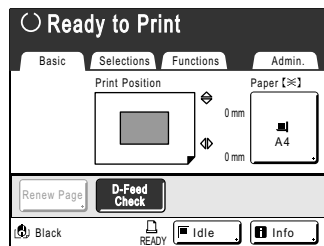

- Touch **[Scanning]** to display the Scan Basic Screen.

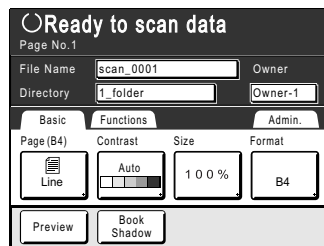

- Touch **[Link Print]** to display the Link Basic Screen.

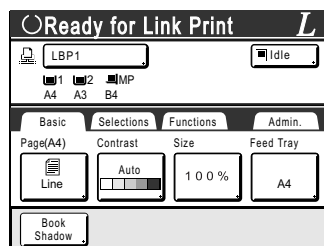

Other Screens

◆ Selections Screen

Quickly change settings for a function or open its screen.

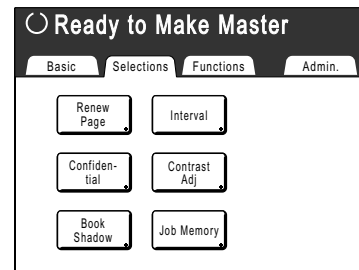

◆ Functions Screen

Access to a variety of functions.

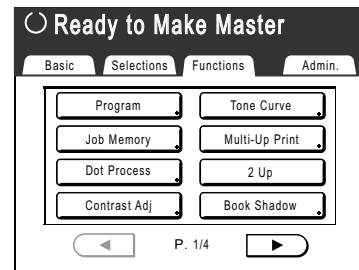

◆ Admin. Screen

Changes the default values of various functions.

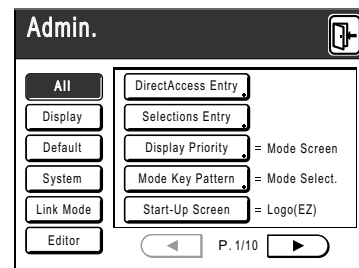
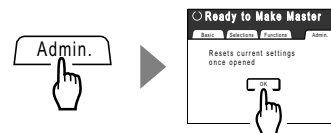

Note:

- Depending upon the usage environment, some of the "Admin." features may not be available ("Admin." tab may not be displayed). Consult your dealer (or authorized service representative) for details.

Getting Acquainted

About Modes

Touch the Mode button on the Mode Screen to view the basic screens of the various modes.

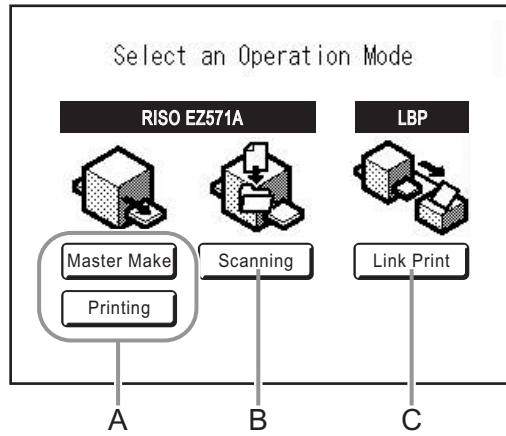

A) RISO Print

On the Operation screen displayed after selecting the Print Mode, you can select the operation of the machine (the operation you are going to do).

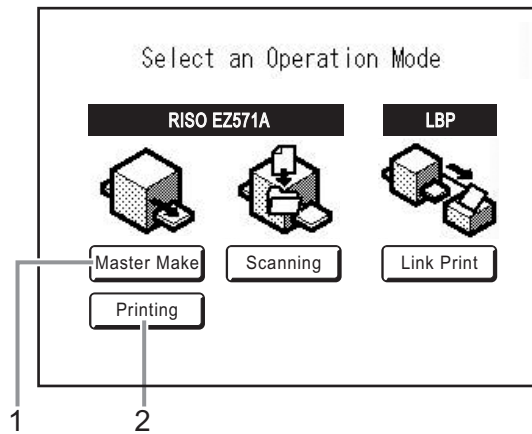

1) Master Make

Scan the original set on the Glass Platen and making a master.

2) Printing

Print with the master currently on the Print Drum (Cylinder). Select **[Printing]** when the master-making operation is not required further after the completion of master-making.

B) Scan Mode

This mode scans the original set on the Glass Platen and stores the scanned data in Storage Memory.

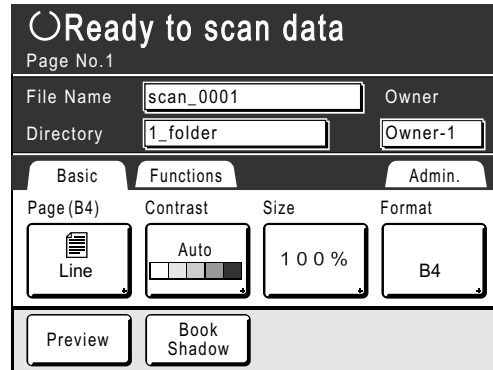

This setting is available when the optional Document Storage Card or USB Flash Drive is attached. The data in Storage Memory can be edited using Editor functions. See "Converting Hard-copies into Stored Data (Scan Mode)" (p.178) for information on the Scan Mode.

C) Link Mode

This mode scans the original set on the Glass Platen and outputs the data using an optional Linked Printer connected to the machine. This process is called "Link Print". When optional Linked Printer is connected to the machine, we recommend that you select [Link Print]. The Link Basic screen displays at start-up.

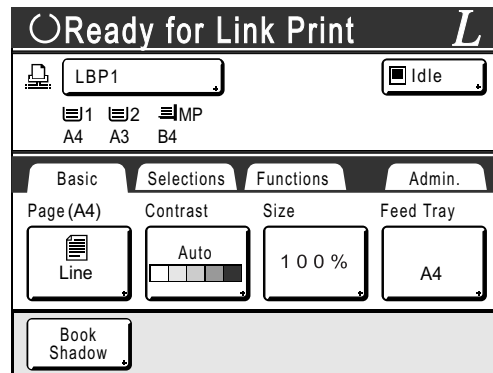

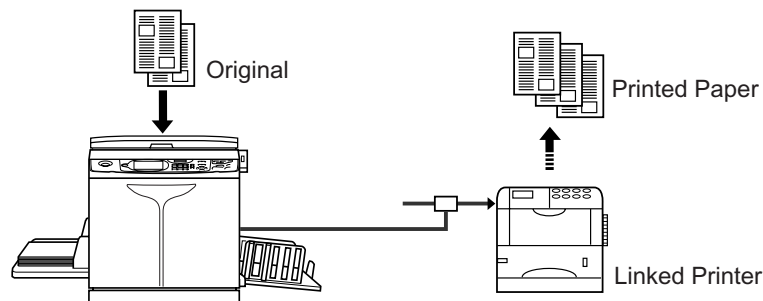

When printing a small number of copies, it is more economical to use Link Print than making a master and printing with the machine. See "When Using a Linked Printer" (p.192) for information on the Link Mode.





Getting Acquainted

Note:

-  key
-  key can be set to function as "Mode Selection" or "Loop".
Select "Mode Key Pattern" on the Admin. screen.

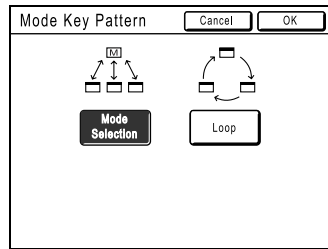
Touch the Mode button on the Mode Screen to view the basic screens of the various modes.



[Mode Selection] Pressing the  key will open the Mode Screen no matter which screen you are currently on.

[Loop] The screen changes as shown below when the  key is pressed.

- Normally: "Master Making Basic Screen" ↔ "Print Basic Screen"
- When a Linked Printer is connected: "Link Basic Screen" ↔ "Master Making/Print Basic Screen"
- When the optional Document Storage Card is installed: "Scan Basic Screen" ↔ "Master Making/Print Basic Screen"

Tip:

About the Recognition Screen

This machine is equipped with a User Management function. (p.106, p.157 "Admin."). If "User Management" is set, the Recognition Screen is displayed. If the one of these screens shown below is displayed, input the PIN code or connect the registered USB Flash Drive. Consult your administrator for the PIN code and the registered USB Flash Drive.

PIN code Input Screen

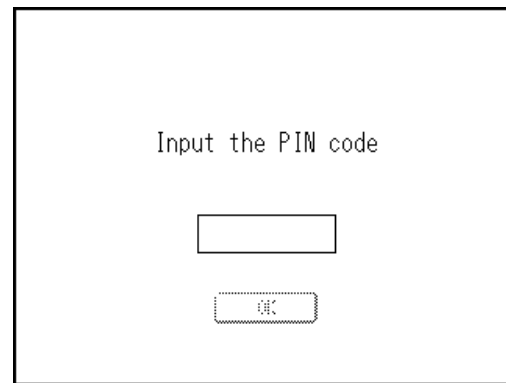

Registered USB Flash Drive Screen

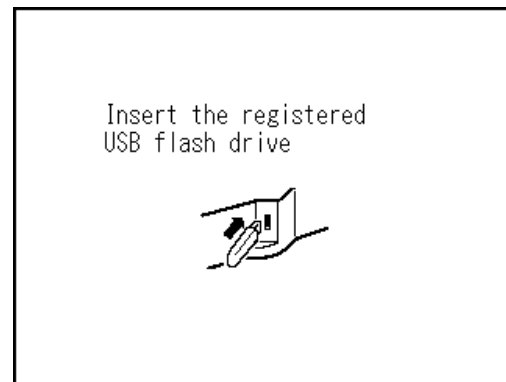

Basic Screen Layout

The name and function of each area of the basic screens are explained below. The display of the basic screen differs depending on whether you are printing from a paper document or printing from a computer.

Printing from a Paper Document



1) Message Area

Displays the printer status and operational instructions. If functions such as Program, ECO mode or Ink Saving are used to print, the program information and/or function icons are displayed.

2) Tab Area

Touch a tab to display its screen.

3) Functions Area

The main functions for master-making/printing steps. Each button shows the current setting. Touch the button to make changes.

4) Direct Access Area

Up to four buttons can be registered in advance. Use this area to register the most frequently-used functions. You can register them on the Admin. screen.

☞ p.168

5) Status Area

Displays the current status of the machine.

: Color (Colour) of the currently installed Print Drum (Cylinder).

: Current status of the Linked Printer. (A Linked Printer will not be displayed unless entered on the Admin. screen.)

- **[ERROR]**: Error in network, etc..
- **[--]**: Linked Printer information cannot be retrieved.
- **[READY]**: Linked Printer is ready.

Pause: Status of data sent from a computer. Touch to display the list of data being received.

☞ p.46

- **[Idle]**: Ready to receive data
- **[Data-Map]**: Processing data for printing.
- **[Pause]**: Ready for output.
- **[Error]**: Error in data transmission.
- **[Blocked]**: Cannot receive data

Info: Touch to display **i** information (consumables information, Print Drum (Cylinder) information, date/time).

☞ p.207

Getting Acquainted

Printing from a Computer Data

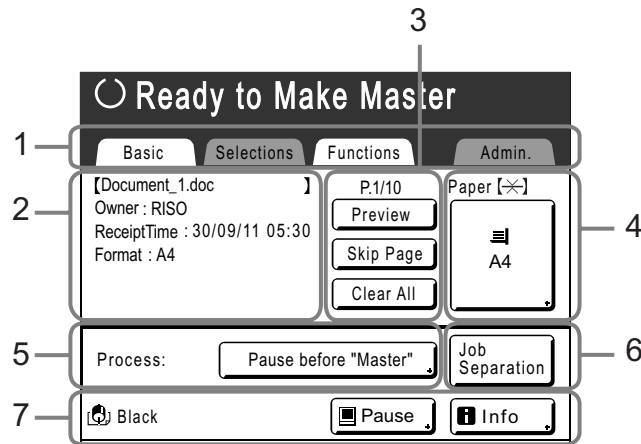

1) Tab Area
 (“Selections” and “Admin.” tabs are disabled)
 Touch a tab to display its screen.

2) Job* Properties Area
 Properties of the current print job is displayed.
 *Refers to the computer data ready for print output.

- 3) Job Operation Area**
- **[Renew Page]:** Create another master when current one is damaged or compromised, without having to download data from the computer.
 - **[Preview]:** Displays the master making image of the page currently awaiting creation. (Available only in the Master Making Basic Screen.)
 - **[Skip Page]:** Stops processing the current page and moves on to process the next page.
 - **[Clear All]:** Stops the current process altogether.

4) Paper Button
 p.63

5) Auto Print
 A printing operation can be set to stop at certain points. (overrides driver settings)
 p.54

6) Optional Device Area
 Displays when an optional device is attached.
 Touch to activate.

7) Status Area
 Displays the current status of the machine.
 This area shows the same information as that on the “Printing from a paper Document” screen.

Buttons on Touch Screen

Select buttons by lightly touching with a finger.
 Touch again to cancel the selection. Avoid pressing with excessive force.

- | | |
|--|---------------------------------------------------------------------------------------|
| | Not Selected. |
| | Selected. |
| | Buttons in gray cannot be selected. |
| | Press a button with a + on the right side to expand options or display Setup screens. |

Frequently Used Buttons

- | | |
|--|--------------------------------------------------------------------------------------------|
| | Activates/Executes a setting. |
| | Cancels a setting. |
| | Closes a current window. |
| | Switch pages. |
| | Increases/decreases selected values (numbers, location, etc.).
Scrolls through screens. |

Basic Process

Printing from a Paper Document

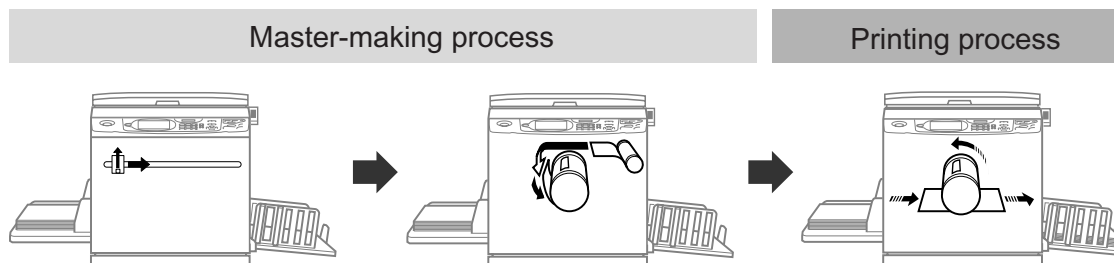

A placed original is scanned by the scanner, and a generated master is rolled around the Print Drum (Cylinder). After a while, proof copy is performed. After checking the print result, enter the number of copies to be printed and start printing.

Printing from a Computer Data

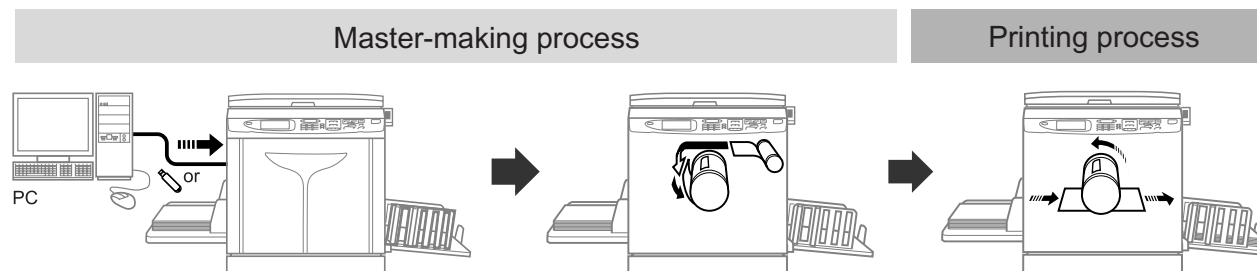

Transfer the original data created with a computer to the machine via a network or USB Flash Drive. A generated master is rolled around the Print Drum (Cylinder). After a while, proof copy is performed. After checking the print result, enter the number of copies to be printed and start printing.

Basic Operations

Preparing to Print

First, set up the Paper Feed Tray and Paper Receiving Tray of the machine.

Important!:

- Do not use unsuitable paper, or mix paper of different sizes. Doing so can cause paper jams and damage the machine.
☞ p.15

Setting up the Paper Feed Tray and Loading Paper

1 Turn the power ON.

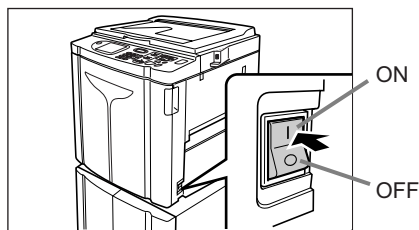

2 Open the Paper Feed Tray.

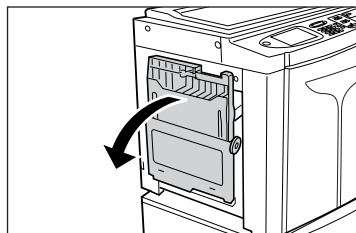

Pull the Paper Feed Tray to open until it comes to a rest.

3 Load paper.

- 1) Place paper in the printing orientation.
- 2) Slide the Feed Tray Paper Guides to fit to the sides of the paper. Then turn the right and left Feed Tray Paper Guide Levers to lock the guides.

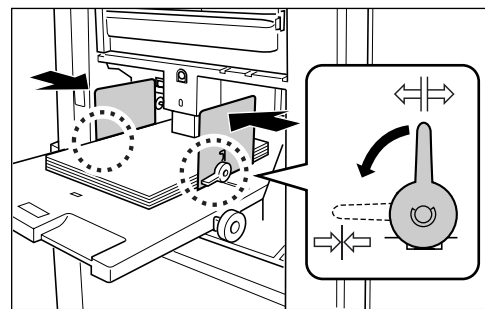

⇄ : Unlock
⇄ : Lock

Important!:

- Make sure that the Feed Tray Paper Guides fit tight up against the paper. Failure to do so can produce undesired results.

Note:

- Custom-sized paper must be registered on the Admin. screen before use.
☞ p.170
Failure to do so may create an incomplete master.

4 Select the paper feed pressure.

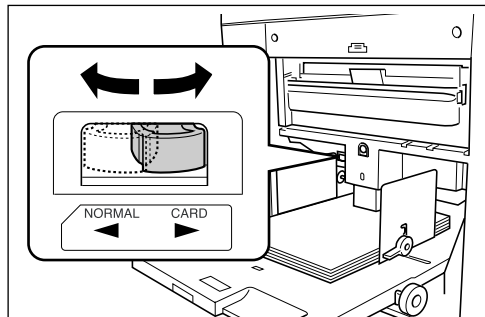

Position the Paper Feed Pressure Adjustment Lever according to the finish of the paper.

NORMAL (☒): For standard or thin paper

CARD (☐): For thick or smooth-surface paper

Note:

- The setting condition of the paper feed pressure is displayed at the top of the **[Paper]** button on the Basic Screen.

5 Check the Basic Screen.

- Select a mode.
- Touch **[MasterMake]** on the Operation Selection Screen.
The Master Making Basic Screen appears.

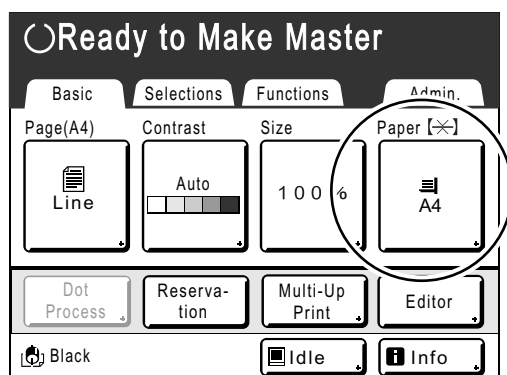

Note:

- Paper size is automatically detected. If the size display shows **[Custom]** even if a standard-sized paper is loaded, the Feed Tray Paper Guides are not properly set against the paper. Make sure that the paper fits tightly against the Feed Tray Paper Guides.

☞ p.32

Basic Operations

Adding or Replacing Paper

When you add paper or replace with paper of a different size at the time of printing, press the Feed Tray Ascent/Descent Button to lower the Paper Feed Tray.

- The Paper Feed Tray is lowered while you press and hold the button, and when you release the button, the tray stops at that position.
- When the tray runs out of paper or you remove all paper, the tray is automatically lowered to the bottom.

Important!:

- When changing to a different paper size, remember to readjust the Receiving Tray Paper Guides and Paper Stopper. (p.35)
- When changing to a different quality paper, remember to adjust the Paper Feed Pressure Adjustment Lever.

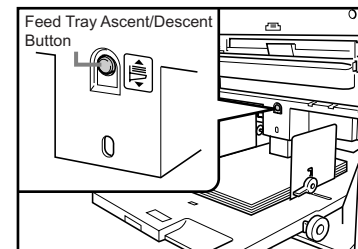

Closing the Paper Feed Tray

Before closing the Paper Feed Tray, remove the paper and widen the Feed Tray Paper Guides to the limits. Then close the Paper Feed Tray.

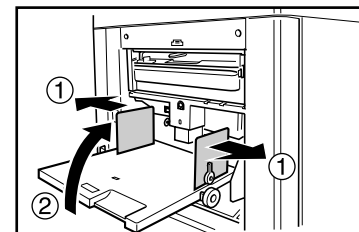

Setting up the Paper Receiving Tray

1 Open the Paper Receiving Tray.

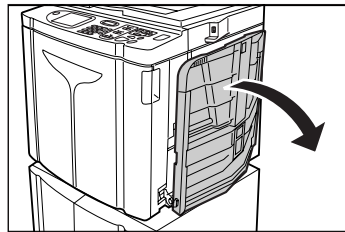

Pull the Paper Receiving Tray down until it comes to a rest.

2 Position the Receiving Tray Paper Guides.

- 1) Raise the Receiving Tray Paper Guides.
- 2) Hold their lower part and slide them to fit the paper width.

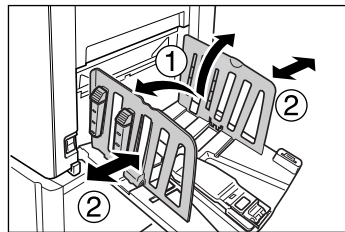

Important!

- For thick paper such as drawing paper, position the Receiving Tray Paper Guides a little wider than the actual paper width.

3 Set the Paper Stopper.

- 1) Raise the Paper Stopper.
- 2) Slide to fit the length of the paper.

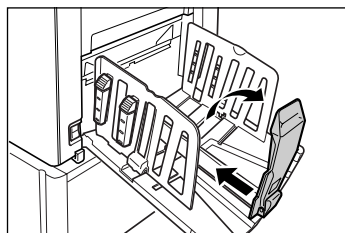

4 Adjust the Paper Arrangers.

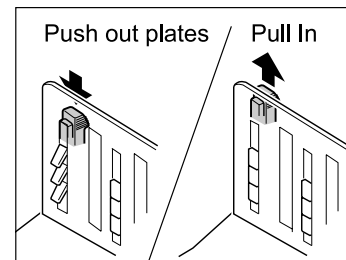

Alignment of paper is affected by sizes and strength of paper. Adjust the Paper Arrangers so that printed paper is aligned.

Press the Paper Arranger to push the plates out, pull up to pull them in.

◆ For plain paper

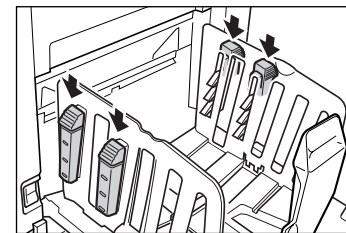

Press to open all of the four Paper Arrangers.

◆ For plain paper with images lopsided on page

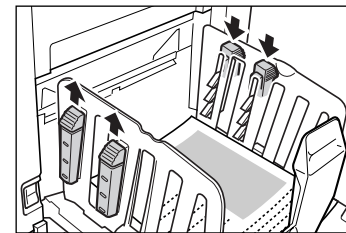

Press to open the two Paper Arrangers on the more heavily printed side.

◆ For thick paper

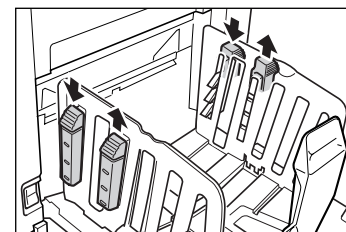

Press to open the two Paper Arrangers (right and left) closer to the machine.

Basic Operations

Closing the Paper Receiving Tray

Remove all printed copies and follow the steps below to close the Paper Receiving Tray.

- 1) Slide the Paper Stopper to the edge of the Paper Receiving Tray.

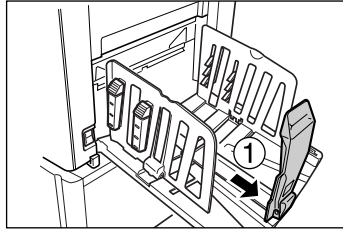

- 2) Fold in.

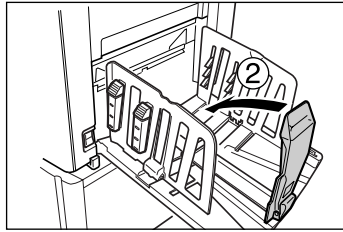

- 3) Pull up the Paper Arrangers, slide the Receiving Tray Paper Guides to the left and right as far as they will go.

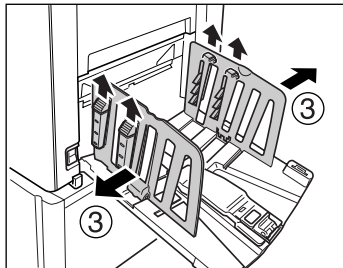

- 4) Fold in.

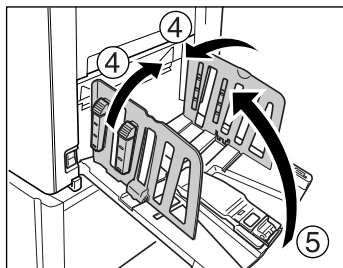

- 5) Close the Paper Receiving Tray.

Placing the original

When placing on the Glass Platen

Open the Platen Cover and place the original face-down. Align the center of the original with the mark on the left-hand side of the glass. After placing the original, slowly close the Platen Cover.

Magazines, books, scrap books, etc. should be placed on the Glass Platen. [p.18](#)

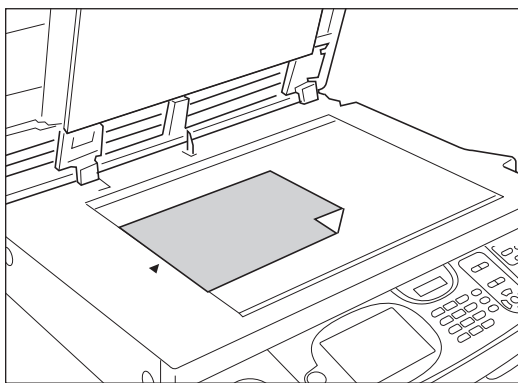

Note:

- If the Gauge Cover is installed, place the original underneath.

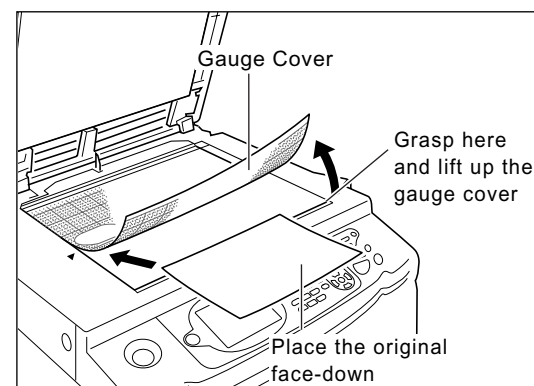

When placing in the ADF unit (Option)

Use the ADF unit if you are printing multiple originals in succession.

Place originals so that the one to be scanned first is on the top. Afterwards, align the ADF Original Guide with the page width and set originals fully to the rear of the ADF.

Important!:

- The placeable original size of 100 mm × 148 mm ($3^{15}/_{16}$ " × $5^{27}/_{32}$ ") and above.
If the original is smaller than the paper size that can be set in the ADF unit, place the original on the Glass Platen.
- Do not place multiple originals of differing sizes or otherwise unsuitable originals into the ADF unit.
It might cause paper jams and damage the machine.
[p.17](#)
- Once the originals are placed into the ADF unit, "Auto Process" setting is turned ON. Press the  key to turn it OFF. Default "Auto Process" setting for the ADF unit can be changed on the Admin. screen.
[p.159](#)

Note:

- Up to 50 sheets of 80 g/m² (21-lb bond) paper can be placed in the ADF unit.
- To print a proof copy after each master-making process, select **[ADF Semi-Auto]**.
[p.147](#)

Basic Operations

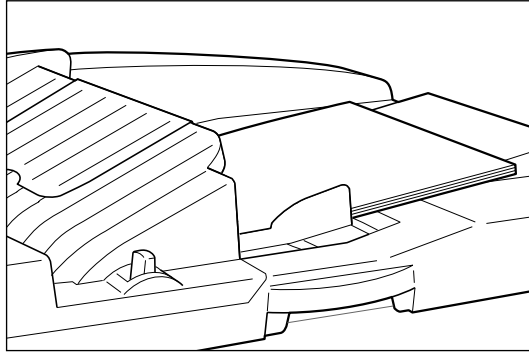

Set the original face-down.

Important!:

- The placeable original size of 100 mm × 148 mm (3¹⁵/₁₆" × 5²⁷/₃₂") and above.

Tip:

Setting Direction (direction of text on the original)

The original setting direction is decided by the number of pages set when using "Multi-Up Print" function. Set the original according to the direction of text on the original seen from the touch panel side.

Align Top

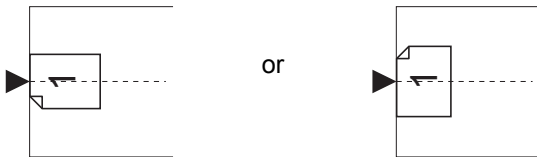

Align Side

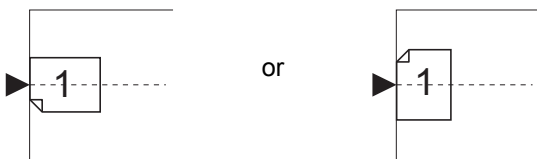

Printing from a Paper Document or Book

The steps for scanning an original for printing is explained below.



Note:

- See “When using a Linked Printer” (p.192) to print from a Linked Printer with Auto-Link function.
 (“Auto-Link” function is not available for EZ591U.)

1 Make sure the machine is ON.

Check the Control Panel.

Note:

- When the power is OFF, both the Display and the  key are off. Turn the power ON.
p.32
- If the  key is lit, the machine is in Energy Saving mode. Press the  key to cancel Energy Saving mode.

2 Check for printing paper.

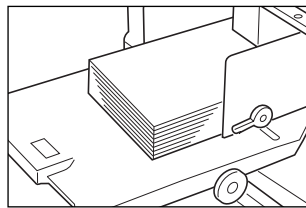

Make sure paper is loaded.

To load or to change the paper, see the following page:

p.32

After replacing with paper of a different size, adjust the position of the Receiving Tray Paper Guides and Paper Stopper.

p.35

3 Check the Display.

◆ When the recognition screen is displayed.

Follow the message on the screen.

For details, see p.43.

The initial screen will be displayed after the user has been identified.

◆ When the initial screen is displayed

Proceed to step 4.

The initial screen differs depending on the setting of “Display Priority” of “Admin.”.

4 Touch [MasterMake] on the Operation Selection Screen.

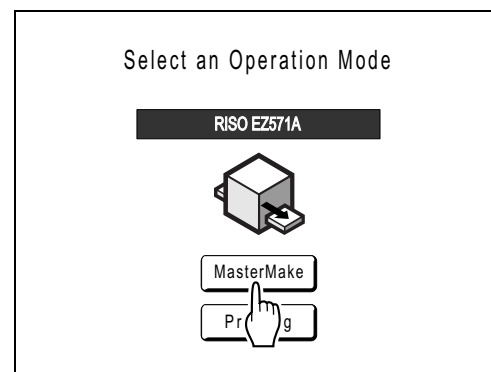

The Master Making Basic screen appears.

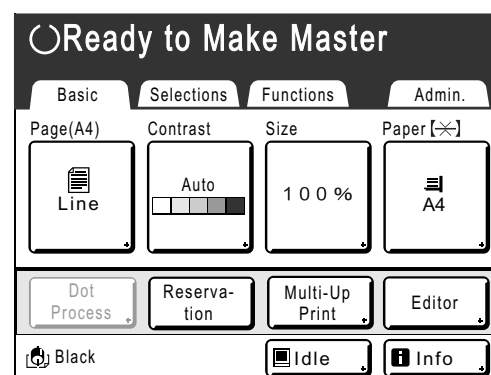

Basic Operations

Note:

- When you see **[Data-Map]** in the Status Area, the machine is busy receiving electronic data from the computer. Please wait a moment.
- When the following screens are displayed, follow the message on the screen. For details, see [p.43](#).

5 Place the original.

Place the original on the Glass Platen or in the ADF unit (Option).
To place the original, see [p.37](#).

6 Configure print functions.

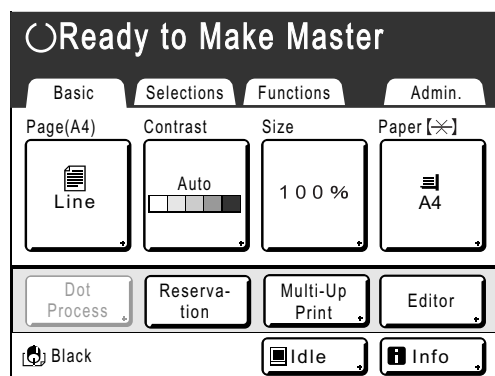

Make sure the Master Making Basic Screen is displayed and make various settings if needed. If the Master Making Basic Screen is not displayed, press the  key. In the Master Making Basic Screen, select functions as needed.

Note:

The following selections are available:

- Image Processing mode ([p.56](#))
- Scanning Contrast ([p.58](#))
- Size ([p.59](#))
- Paper ([p.63](#))
- Auto Process ([p.64](#))
- Dot Process ([p.65](#))
- Contrast Adj ([p.66](#))
- Tone Curve ([p.67](#))
- Ink Saving ([p.68](#))
- 2 Up/Multi-Up Print ([p.69](#))
- Book Shadow ([p.81](#))
- Top Margin ([p.83](#))
- Side Margin ([p.85](#))
- Preview ([p.87](#))
- Confidential ([p.141](#))
- Interval ([p.97](#))
- Jump Wing Control ([p.98](#))
- Special Paper Ctrl ([p.98](#))
- Reservation ([p.142](#))
- Max. Scan ([p.90](#))
- Program ([p.123](#))
- Job Memory ([p.134](#))
- Idling Action ([p.143](#))
- Renew Page ([p.144](#))
- ADF Semi-Auto ([p.147](#))
This setting is available when the ADF unit (Option) is installed.
- Job Separation
This setting is available when the Job Separator (option) is installed.
- Storage Memory
This setting is available when the Document Storage Card (Option) is attached.
- Overlay ([p.187](#))
This setting is available when the Document Storage Card (Option) is attached.
- Auto-Link
This setting is available when connecting a Linked Printer to the machine. This setting is not available for EZ591U.

7 Check the Paper Receiving Tray.

Adjust the position of the Receiving Tray Paper Guides and Paper Stopper to match the paper size used.

[p.35](#)

8 Press the key.

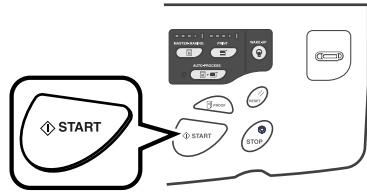

Starts scanning of the original. A master is made once the scan is completed, and a proof copy will be printed.

Note:

- When “Auto Process” is selected, the process will be different.
☞ p.64

9 Check the proof copy result.

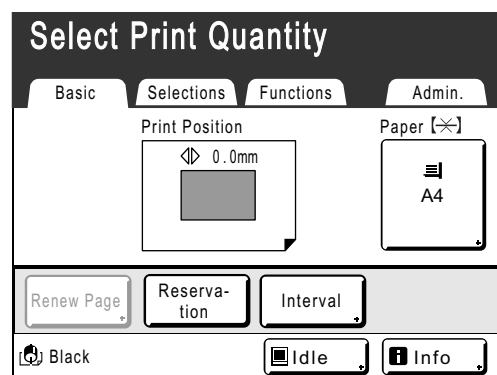

When a proof copy is printed, the Print Basic Screen will be displayed automatically. Check the proof copy; e.g., print position and density.

If necessary, change print position and density.

- Print Position (☞ p.94)
- Print Density (☞ p.93)
- Interval Printing (☞ p.97)
- Jump Wing Control (☞ p.98)

After adjustment, press the  key to print a proof copy.

Important!:

- When the machine has not been used for a long period of time, the print quality may suffer due to dry ink on the Print Drum (Cylinder). Press the  key to print proof copies several times.

Note:

- You can also adjust the print position (up and down only), the density, and the speed while print process is in progress.

10 Enter the number of copies using the Print Quantity Keys.

The entered number is displayed on the Print Quantity Display.

Note:

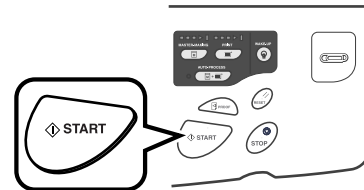

- To change the number, press the  key, then re-enter the correct number.

11 Press the key.



The specified number of copies will be printed.

Note:

- Press the  key to interrupt printing operation currently underway.
- When printing from a computer, if the machine is inactive for a certain period of time, it determines that the current job is completed, even if the actual printing is still under way. If another person accidentally initiates another job from the computer, this will cause a new master to be made, discarding the current one. To prevent this from occurring, you may set a “Reserve Period”. We recommend that you activate the “Reservation” setting when printing leaflets, etc. to prevent interruption.
☞ p.142
- Easily restore current settings by saving them into memory. Saved settings can be retrieved even when the  key is pressed, or after turning the power off.
☞ p.134

Basic Operations

12 Press the key when print job is complete.

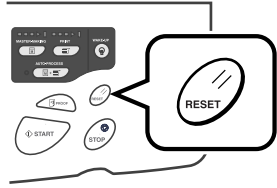

The setting returns to its default value.

Note:

- After printing is completed, the master remains on the Print Drum (Cylinder). To protect confidential documents from unauthorized duplication, use the Confidential feature to discard the master after printing.
☞ p.141
- Even if you do not press the  key, with the passage of a certain amount of time (factory default setting: 5 minutes), the setting will be automatically reset.
☞ p.134

13 Remove the printed paper.

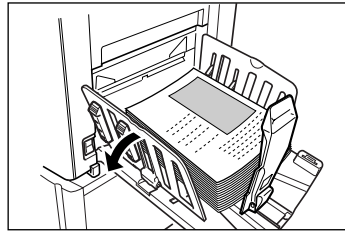

Open the Receiving Tray Paper Guides and remove the paper.

Tip:

When Linked Printer is connected to the machine (Not available for EZ591U)



“Auto-Link” changes the Output Tray according to the print quantity.

The factory default setting is output from the machine when the print quantity is 20 or more and output from a Linked Printer when the print quantity is 19 or less.

When the following functions are set, however, the machine will print copies regardless of the number of copies.

- 2 Up
- Layout
- Program
- Ink Saving

Important!:

- Make sure to enter the print quantity before pressing the  key.
The original is printed by switching the Output Tray to match on the quantity.
If you press the  key when the print quantity is 0, master-making from the machine will start.

Note:

- You can change “Link-Free Volume” from “Admin.” so as to switch the Output Tray.
☞ p.164

Tip:

Auto Idling

When “Auto Idling” is set to ON, idling operations may occur when master-making process is initiated.

Factory default is set to idle automatically at the beginning of the master-making when the machine is inactive for over 12 hours.

To toggle “Auto Idling” ON/OFF, or to modify number of hours before activating next idling, go to the Admin. screen.

☞ p.163

Idling can also be manually initiated when making a master.

☞ p.143

**Tip:
Operations on the Recognition Screen**

When "User Management" is set by the administrator, the users will be asked to identify themselves ("User identification access": if he/she is registered or not) during operations.

The user identification procedures will differ according to the Recognition and Identification System decided by the administrator. [p.106](#)

Note:

- A PIN code and USB Flash Drive are used in the Recognition and Identification System. Contact your administrator for the PIN code and the USB Flash Drive you have to use.

◆ When the PIN code Input Screen is displayed

Enter the PIN code using the Print Quantity Keys and touch **[OK]**.

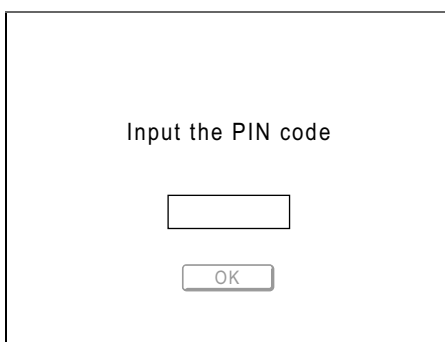

The initial screen will be displayed after the user has been identified.

Note:

- If an incorrect PIN code is entered, an error message will be displayed. Re-enter the correct PIN code.

◆ When registered USB Flash Drive Screen is displayed

Connect the registered USB Flash Drive to the USB slot.

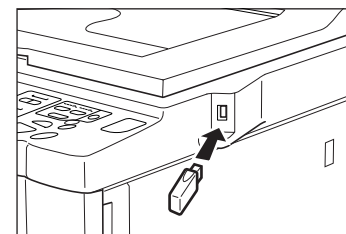
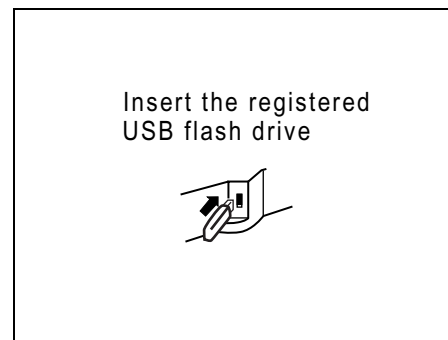

The initial screen will be displayed after the user has been identified.

Note:

If an unregistered or unusable USB Flash Drive is connected into the machine, an error message will be displayed. Connect the registered USB Flash Drive.

Important!:

After printing is completed, press the  key to log out before leaving the machine. If you do not log out, the logged-in state will remain until "Auto Clear" is activated. During this time, anyone can use the machine (as you) without logging in. For "Auto Clear", see [p.161](#).

Basic Operations

Printing from a Computer Data

[Direct Print] [USB Job List]

This machine can directly print the original created on the computer by connecting the computer and machine by cable. The data will be digitally processed into a master, thus achieving higher quality prints than the master-making of scanned originals.

Furthermore, a USB slot for connecting a USB Flash Drive is supplied with this machine so that you can print by connecting a USB Flash Drive that stores the data of originals to the machine even if the computer and machine are not connected by cable.

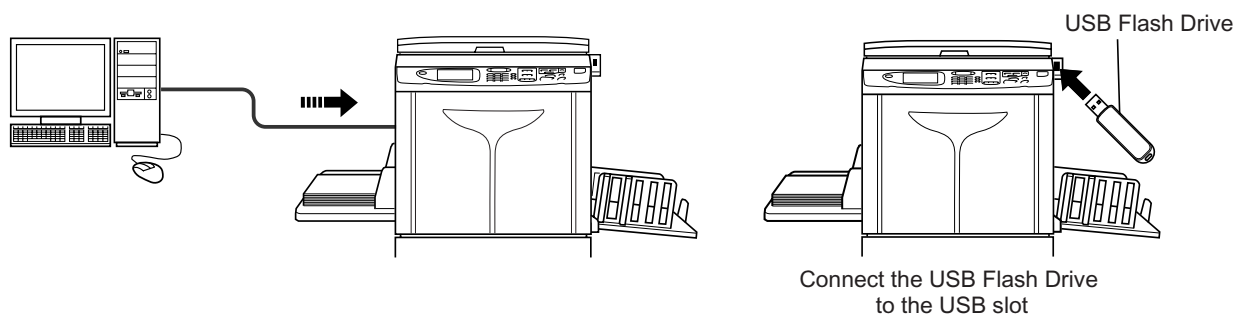

Note:

- First, install a proper printer driver on your computer. See the RISO Printer Driver User's Guide for installation details.
- Document data created on your PC can be stored in the optional Document Storage Card attached to the machine.
- This manual provides only a summary of functions available when printing from a computer. See RISO Printer Driver User's Guide for further details on sending data and other settings.

Auto Process and Stop Timing

Auto Process is a combined automated steps of receiving data from the computer, making a master, and printing. To activate "Process", open the printer properties dialog box on the computer and select "Auto-process". (A proof copy will not be printed.)

During each process, in order to adjust settings or to change paper, you can stop the operation.

To temporarily halt an operation during the creation of a master or during print process, select one of the following three options for "Process" in the printer properties dialog box.

- Pause before "Master"
Halts the operation before master-making:
To change settings, to change paper and to change Print Drum (Cylinder)
- Pause before "Print"
Halts the operation before printing:
To print proof, to adjust ink density, to adjust positioning and to change printing speed
- Auto-process "OFF"
Stops twice; before making a master, and again before printing.

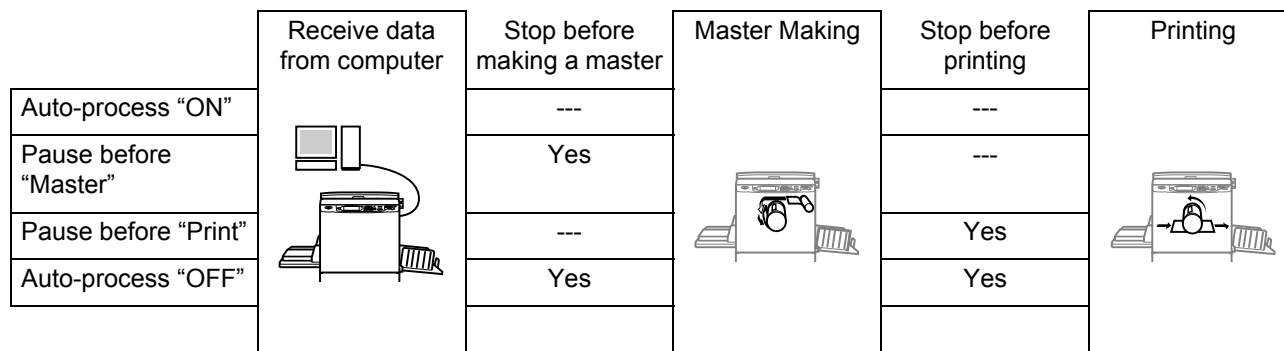

Note:

- The timing for stopping printing can also be changed from the display of the machine.
☞ p.54

Printing Computer Data [Direct Print]

The computer and printer must be connected by cable.

Note:

- When "User Management" is set by the administrator, the users will be asked to identify themselves during operations.
☞ p.43

1 Make sure the machine is ON.

Check the Control Panel.

Note:

- When the power is OFF, both the Display and the key are off. Turn the power ON.
☞ p.32
- The machine automatically wakes up from Energy Saving mode when data is sent from a computer, and it starts processing the data.

2 Check for printing paper.

Make sure paper is loaded.

To load or to change the paper, see the following page:
☞ p.32
After replacing with paper of a different size, adjust the position of the Receiving Tray Paper Guides and Paper Stopper.
☞ p.35

Basic Operations

3 Set printing options from your computer screen.

Use the printer driver.

Important!:

- Make sure to remove the checkmark from the “Collate” option in the Print dialog box.

Note:

- If you are using RISO Network Card, you can check the machine status (power ON/OFF, paper settings, etc.) remotely from your computer monitor.

4 Click [OK] in the print dialog box.

Data is sent from the computer. When the machine receives data, a print job automatically starts in accordance with the printer driver settings. Skip to step 6 if you are printing in Full Auto.

5 Perform printing from the control panel.

The displayed screen and operation procedure differ depending on the “Auto-Process” (Advanced tab) setting of the printer driver.

◆ Printing with Pause before “Master”

The Master Making Basic Screen in step 2) is halted depending on the use of the machine or Admin. settings. In this case, press the  key.

- 1) Touch .

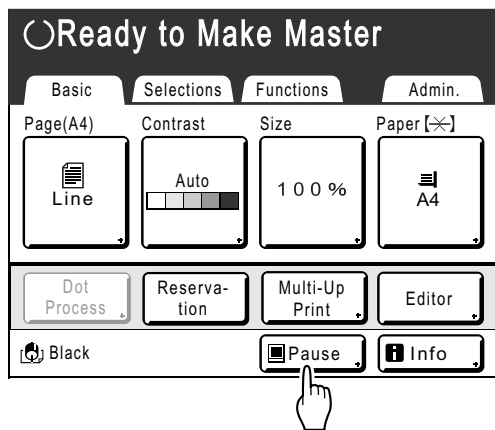

The Job List screen is displayed.

- 2) Touch [Output].
If you want to operate the ID print, touch [ID Print Job].

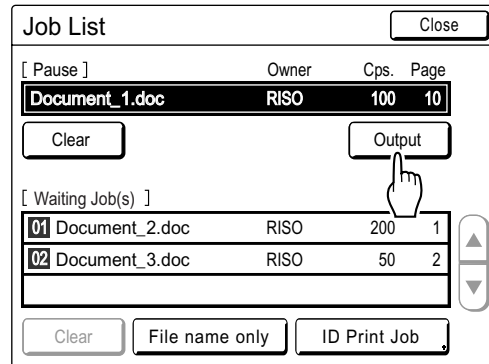

The following screen appears.

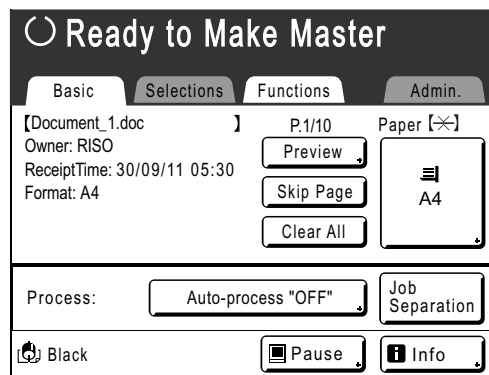

- 3) Press the  key.
After making a master, start printing.

◆ Printing with Pause before “Print”



A master is made after receiving the data. The machine stops after printing a proof copy.

- 1) Check the proof copy and adjust the settings as needed.
- 2) Press the  key.
Printing starts.

◆ Printing with Auto-process “OFF”

- 1) Follow steps 1 to 3 in “Pause before “Master””.
Stop after making a master and printing a proof copy.
- 2) Check the proof copy and adjust the settings as needed.
- 3) Press the  key.
Printing starts.

Note:

- If the data contains multiple pages, repeat the same steps for each page.
- Entering the number of copies from the Print Quantity Keys will override the number specified in the Print dialog box.
- For “ID Print”, printing starts with specified Auto Process mode after recognition.
- To manually stop a job during master-making or printing operation, press the  key. In master-making process, the machine will stop after the master is made. In the printing process, the machine will stop printing.
Press the  key to resume the job.

Note:

- After printing is completed, the master remains on the Print Drum (Cylinder). To protect confidential documents from unauthorized duplication, use the Confidential feature to discard the master after printing.
☞ p.141

Tip:

When Linked Printer is connected to the machine (Not available for EZ591U)

“Auto-Link” changes the Output Tray according to the print quantity.

☞ p.157

☞ p.192

6 Remove the printed paper.

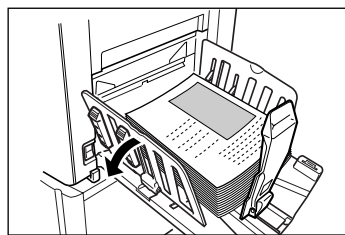

Open the Receiving Tray Paper Guides and remove the paper.

Basic Operations

Tip: Job List Screen

[Pause]	Owner	Cps.	Page
Document_1.doc	RISO	100	10

Clear Output

[Waiting Job(s)]

Document_2.doc	RISO	200	1
Document_3.doc	RISO	50	2

Clear File name only ID Print Job

Once the data is received, touch **[Pause]** on the Basic Screen to review current Job List. From the Job List screen, you can initiate output for jobs pausing for output, or cancel jobs that are “Paused/Data-Mapping/Waiting”.

Tip: ID Print

The data sent from the printer driver as the “ID Print” is retrieved from the ID Print Job Screen and printed.

Touch **[ID Print Job]** to display the Recognition Screen, and follow the message on the screen. The timing of the Recognition Screen differs depending on the “User Management” setting set by the administrator. [p.162](#)

[Pause]	Owner	Cps.	Page
Document_4.doc	RISO	25	3
Document_5.doc	RISO	300	1

Clear Output

[Waiting Job(s)]

Clear File name only

Note:

- To set the “ID Print” in the printer driver, a user registration number (ID) is required (one or two digits). Contact your administrator for the PIN code or registered USB Flash Drive, and the user registration number (ID).

Printing USB Data [USB Job List]

Even if the computer and machine are not connected by cable, you can print original data via a USB Flash Drive. It is useful when the computer and printer are placed in different places.

Note:

- When "User Management" is set by the administrator, the users will be asked to identify themselves during operations. For details, see [p.43](#).

1 Connect the USB Flash Drive to the computer.

Note:

- If the Recognition and Identification System ("Recognized by") is set to "USB Flash Drive" in the "User Management", it is also convenient for you to use the registered USB Flash Drive for outputting data.

2 Set printing options from your computer screen.

Use the USB flash-via-printer driver.

Note:

- Make sure to remove the checkmark from the "Collate" option in the Print dialog box.



3 Click [OK] in the print dialog box.

The data created on the computer is stored in the USB Flash Drive.

4 Make sure the machine is ON.

Check the Control Panel.

Note:

- When the power is OFF, both the Display and the  key are off. Turn the power ON. [p.32](#)
- If the  key is lit, the machine is in the Energy Saving mode. Press the  key to cancel the Energy Saving mode.

5 Check for printing paper.

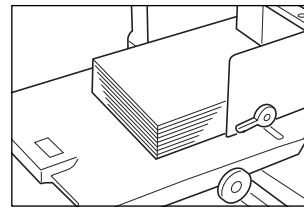

Make sure paper is loaded. To load or to change paper, see following page.

[p.32](#)

After replacing with paper of a different size, adjust the position of the Receiving Tray Paper Guides and Paper Stopper.

[p.35](#)

6 Connect the USB Flash Drive that contains the original data to print to the USB slot.

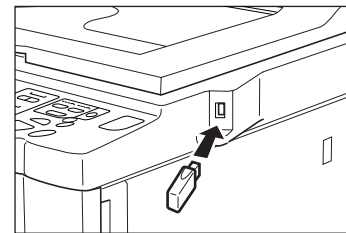

If you use an unregistered USB Flash Drive for outputting data, skip to step 9.

Important!:

- Do not remove the USB Flash Drive until the printing is completed. It might cause loss of data and settings or damage to the USB Flash Drive.

Basic Operations

Note:

- If the “USB print (Auto process)” has been set as the output method (Basic tab), connecting the USB Flash Drive starts master-making/ printing process as per the “Auto Process” setting. For detailed settings, refer to the “RISO Printer Driver User’s Guide”.

7 Touch [Functions] on the Master Making Basic Screen.

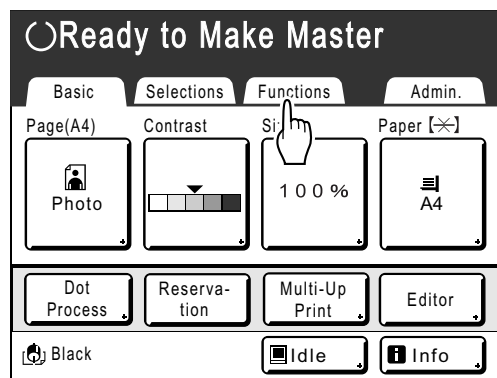

8 Touch [USB Job List].

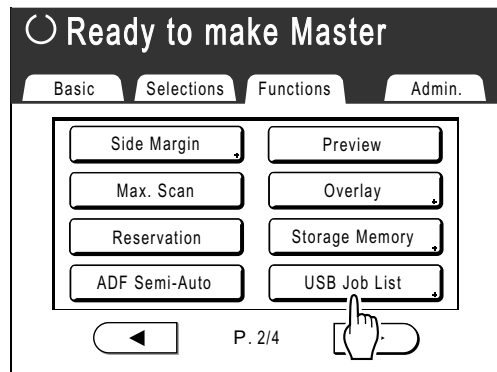

The USB Job List Screen (with “Non-ID Print”) is displayed.

(The “ID Print Job” button is displayed on the screen.)

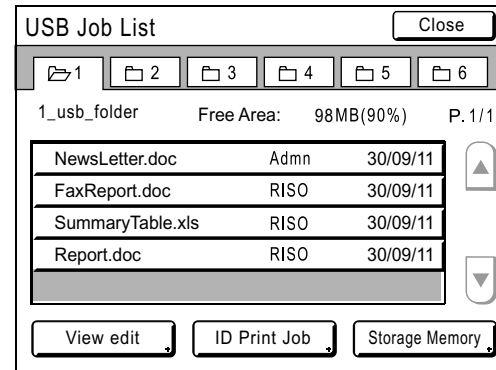

9 Touch the data to print.

The “USB Job List” retrieve screen is displayed. If you are selecting data stored in a different folder, touch that folder’s tab.

Note:

- To retrieve the ID print, touch [ID Print Job].
- When “Management Level” is set to “Low/ Admin tab only” in the “User Management”, [ID Print Job] will not be displayed.
- If the stored data is not shown on the screen, touch ▲ or ▼ to display it.

10 Confirm the retrieved data.

Use the thumbnail to check whether the specified data is the desired data or not.

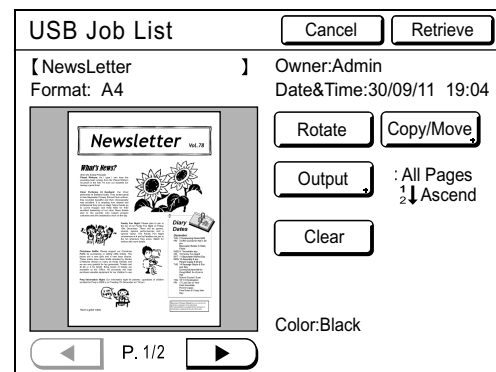

From the “USB Job List” retrieve screen, you can confirm retrieved data and specify output settings. See p.186 for operational details.

11 Touch [Retrieve].

The data is retrieved and the Storage Mode Basic Screen appears.

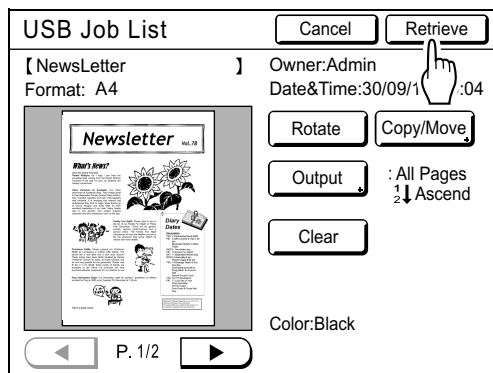

The following screen appears.

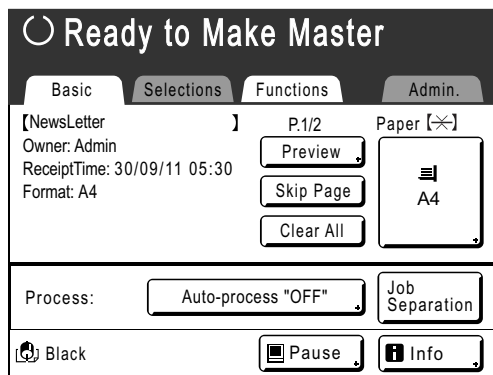

Note:

- You can change the output directions and stop timing settings on Master Making Basic Screen. For details, see [p.52](#) and [p.54](#)

12 Enter the number of copies using the Print Quantity Keys.

The entered number is displayed on the Print Quantity Display.

13 Press the key.

Data is printed.
After this, follow the same operations for paper documents.

Basic Operations

Changing Output Directions

Output can be controlled from the Master Making/Print Basic Screens.

◆ Master Making Basic Screen

- **[Preview]**
You can check the master making image of the page currently awaiting creation.
- **Note:**
 - In "Preview", all received original data is displayed as a master making image. The outside of print area is not actually printed.
- **[Skip Page]**
Cancels a pending page, and start processing the next page. Use this button when current file has extra, unwanted pages.
- **[Clear All]**
Deletes all currently queued jobs. Use this button to delete a job sent by a mistake, or pending jobs no longer needed.

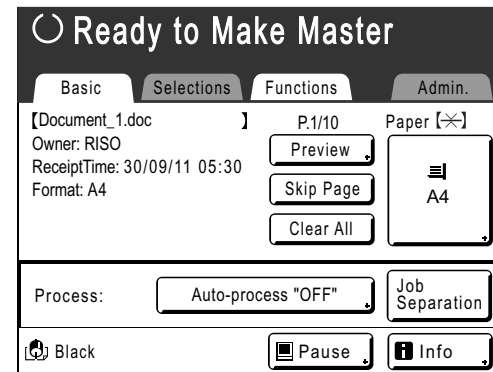



◆ Print Basic Screen

- **[Renew Page]:**
You can recreate another master when the current one is damaged without having to receive original data from the computer.
- **Note:**
 - If multiple pages exist, only the last page will be processed.
 - "Rotate" can also be specified.
 - The confirmation screen for each respective button appears when touched. Touch **[OK]** to implement the instructions.

Important!:

- **[Skip Page]** and **[Clear All]** are disabled during master-making or printing processes. Press the  key to modify directions while master-making or printing is in progress. (In master-making process, the operation will stop after the master is made. In print process, the print job is halted.)

Note:

- Pressing either the  key or the  key while waiting for a command (under Ready to Make Master/Ready to Print screens) will delete the pending job.

When selecting [Skip Page]

1 Touch [Skip Page].

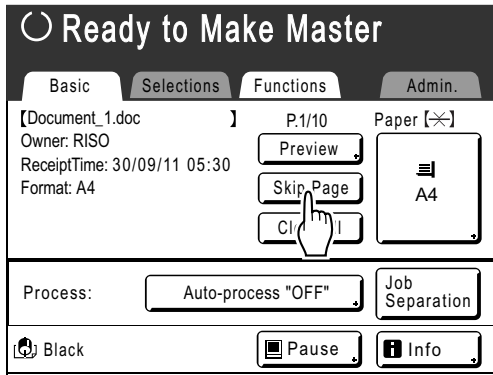

2 Touch [OK].

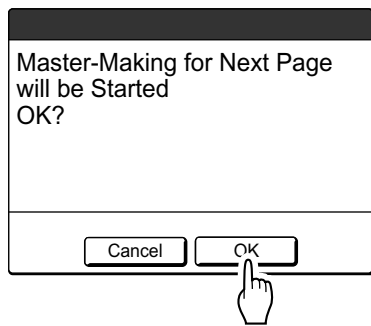

Stops processing the current page and moves on to process the next page.

When selecting [Clear All]

1 Touch [Clear All].

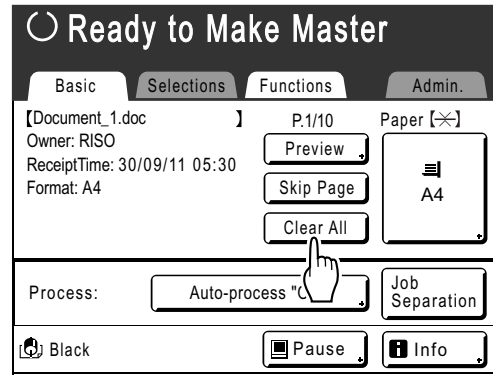

2 Touch [OK].

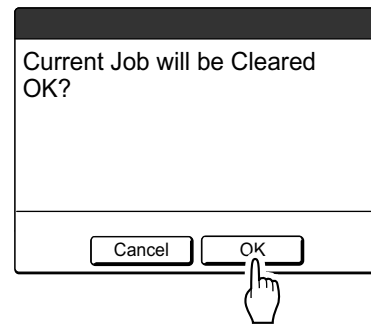

Clears current job. Starts processing next data in queue.

Basic Operations

Changing Stop Timing

Stop timing as set on the printer driver takes priority by default. However, the settings can be changed on the machine while the machine is halted.

Note:

- If "Process" is set to "Auto-process" in the Printing Property of the Printer Driver, press the  key to stop the operation and to make changes.

1 Touch the "Process" function button.

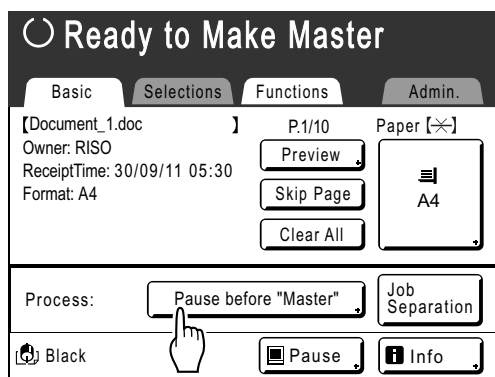

The Auto Print screen appears.

2 Select the desired function.

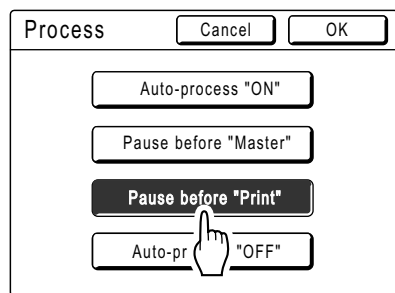

- **[Auto-process "ON"]:** Makes a master then automatically prints.
- **[Pause before "Master"]:** The operation stops before making a master.
- **[Pause before "Print"]:** After a master is made and a proof copy is printed, the operation stops.
- **[Auto-process "OFF"]:** Stops before making a master, and then again before printing.

Note:

- See [p.46](#) for details regarding operations after each stop.

3 Touch [OK].

Returns to Basic Screen. Auto Print setting is updated.

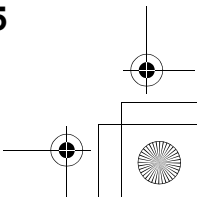
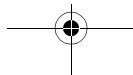
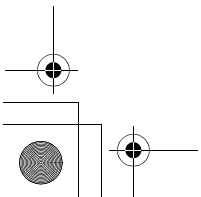
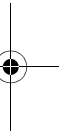
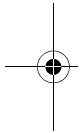
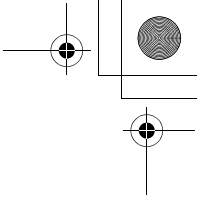

Functions for Master-Making

Selecting Image Processing Mode [Image]

In order to make a master best suited for the original document, select an appropriate mode depending on whether original contain only text (Line), photo, or both of them.

Note:

- Default Image Processing mode can be set on the Admin. screen.
p.159

1 Touch [Image] on the Master Making Basic Screen.

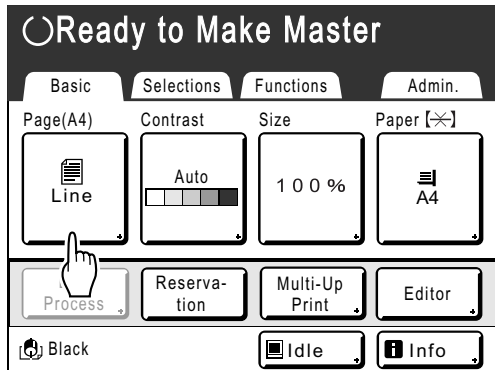

2 Select the appropriate Image Processing mode for the original.

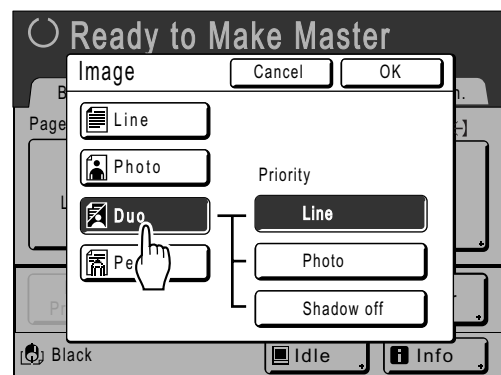

- **[Line]:** Only text contained; e.g., text document, newspaper
- **[Photo]:** Only photos contained
- **[Duo]:** Both text and photos contained
- **[Pencil]:** Pencil drawings or lightly printed documents

Touch **[Photo]**, **[Duo]** or **[Pencil]** to select more detailed settings.

Image (Detailed settings)	Description
[Photo]	
Standard	Select for photos other than [Portrait] or [Group] .
Portrait	Use this setting for pictures of one or two individuals from the bust up. This type of image processing is particularly good for printing photos of faces.
Group	This setting is for group photos that are over-exposed. This process is effective for restoring facial features that have become washed out by a flash. The Group setting is not for photos with faces that are overly dark. It may be more effective to select [Standard] for such photos.
[Duo]	
Line	Select to print small text clearly.
Photo	Select to print photos more clearly (brightly).
Shadow off	Select to clear the background color (colour) of the dark-color (colour) originals (such as newspapers). [Shadow off] is selectable aside from [Line] and [Photo] .
[Pencil]	
Darker	Select to print faint originals clearly.
Lighter	Select to print cut-and-pasted pencil drawings with shadows.

3 Touch [OK].

Returns to the Master Making Basic Screen.
Image Processing mode is updated.

Note:

- Some functions are not available in certain Image Processing mode settings.

	Line	Photo	Duo	Pencil
Dot Process	—	✓	✓	—
Contrast (Auto)	✓	—	—	—
Contrast (1-5)	✓	✓	✓	✓
Contrast Adj	—	✓	—	—
Tone Curve	—	✓	✓	✓

✓ : available — : not available

- In the **[Line]** mode, when **[Contrast]** is set to **[Auto]**, the background color (colour) of the original is automatically deleted.
☞ p.58

Functions for Master-Making

Selecting Scanning Contrast for the Original [Contrast]

Scanning contrast can be adjusted to accommodate the density of the original. Specify by selecting Auto or numeric levels (1-5). In the Auto mode, "Contrast" is automatically adjusted to the background color (colour) of the original for printing.

Important!:

- "Auto" is available only when Image Processing mode has been set to "Line".
☞ p.56
- When the Ink Saving mode is selected, you cannot adjust the "Print Density".

Note:

- Default Scanning Contrast can be set on the Admin. screen.
☞ p.159

1 Touch [Contrast] on the Master Making Basic Screen.

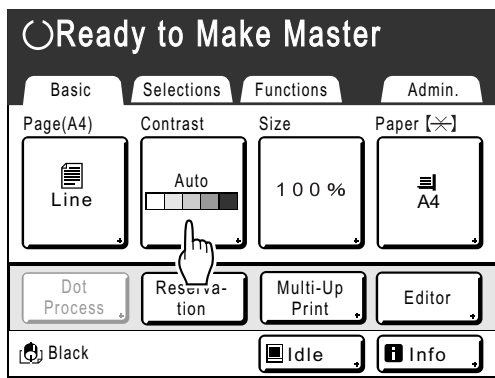

2 Touch the desired contrast or [Auto].

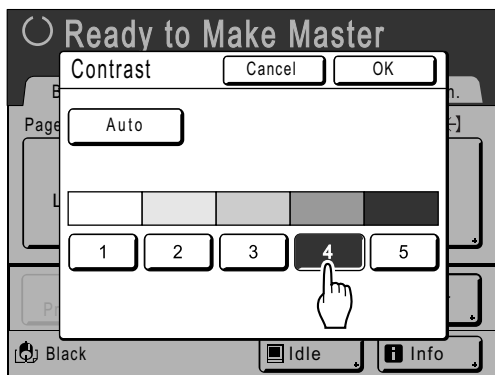

Levels of scanning contrast

- 1) : Very Light
- 2) : Light
- 3) : Standard
- 4) : Dark
- 5) : Very Dark

3 Touch [OK].

Returns to the Master Making Basic Screen. "Contrast" is updated.

Enlarging/Reducing Originals

[Standard Ratio] [Margin+] [Free] [Zoom]

The document can be printed enlarged or reduced. The following methods can be used to enlarge/reduce the original.

◆ Standard Ratio

Enlarging or reducing a standard-sized original (A4, B5, Letter, Legal, etc.) to print in another standard size.

◆ Auto*

The original can be automatically enlarged or reduced and printed according to the paper size in the Paper Feed Tray.

*"Auto" is available only when the originals are placed in the ADF unit (Option).

◆ Margin+

Reducing the original slightly. This feature is useful when allowing binding margins, or when text or diagram extends beyond the printing area.

☞ p.18

Specify reduction rate of 90%-99% on the Admin. screen.

☞ p.161

Note:

- "Margin+" and "Standard Ratio" can be selected at the same time.

◆ Free

The top/bottom and left/right of the original can be enlarged or reduced and printed as desired.

Specify the enlarging/reducing between 50% and 200% in increments of 1%.

◆ Zoom

Allows you to specify numerical resize ratio.

Specify the enlarging/reducing between 50% and 200% in increments of 1%.

Note:

- To avoid paper jam, flipping or ink smudges on the back side by design the machine does not print too close to the edge. The top edge in particular needs 5 mm ($\frac{3}{16}$ ") of margin space.

☞ p.18

5 mm ($\frac{3}{16}$ ") wide area on the top edge (marked ▲) of the Glass Platen or the ADF unit (Option) cannot be scanned, regardless of enlargement or reduction settings.

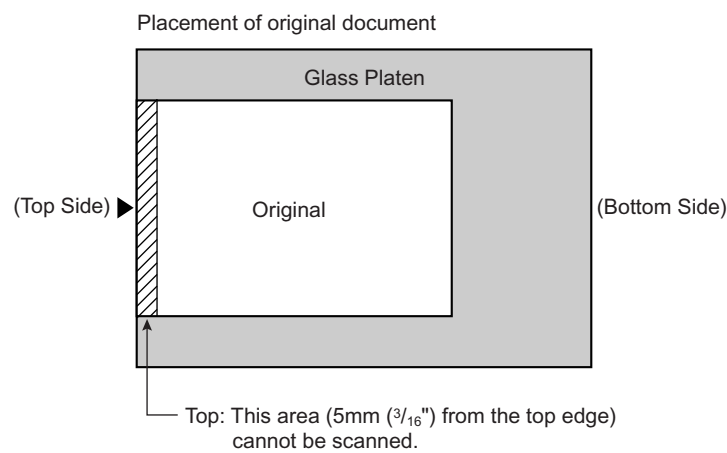

- Do not position the original within 5 mm ($\frac{3}{16}$ ") of the top edge, or the top edge of its printed image will be cut off. This 5 mm ($\frac{3}{16}$ ") margin will remain even in the "Max. Scan" setting. ☞ p.90
- If the original document has no margin on its top edge, the top 5 mm ($\frac{3}{16}$ ") of its print will be cut off even when "Margin+" is selected. Move the original about 5 mm ($\frac{3}{16}$ ") inwards from the top edge of the Glass Platen and reduce the size.

Functions for Master-Making

Enlargement and Reduction by Standard Ratio [Standard Ratio] [Margin+] [Auto]

1 Touch [Size] on the Master Making Basic Screen.

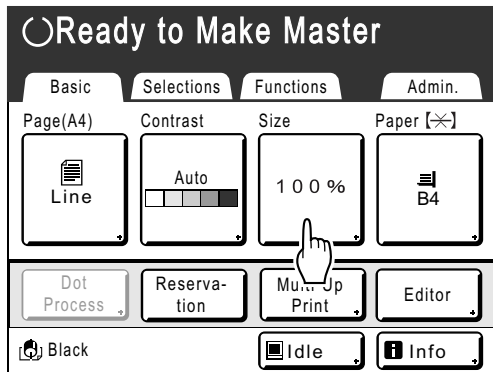

2 Touch the button corresponding to the desired size.

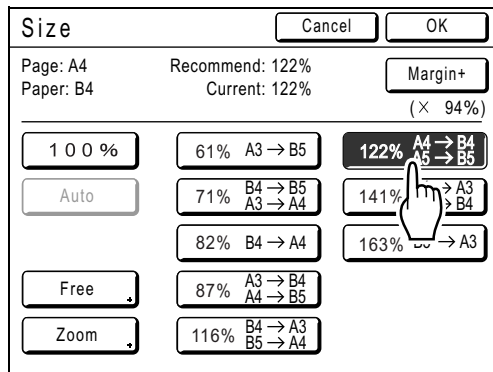

Touch **[100%]** to restore the original size.
For original with no margins, touch **[Margin+]** before printing.

Important!:

- The "Margin+" setting is not available when "Auto", "Free" or "Zoom" is selected.

Note:

- "Standard Ratio" and "Margin+" can be selected at the same time. The "Current" field will indicate the combined result of "Standard Ratio" × "Margin-Plus Rate" when both are selected.
- When the page size (original size) is not detected, "---" is displayed.

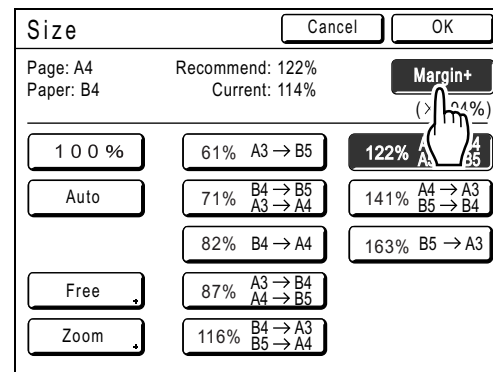

3 Touch [OK].

Returns to the Master Making Basic Screen.
"Size" is updated.

Enlargement/Reduction of a Changed Aspect Ratio [Free]

1 Touch [Size] on the Master Making Basic Screen.

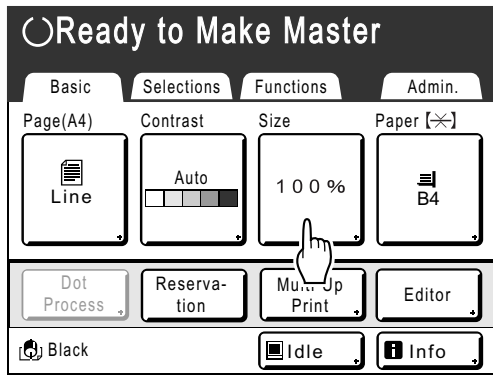

Note:

- Print Quantity Keys can also be used to enter numbers.
- Press the **C** key to restore the original size (100%).

4 Touch [OK].

Returns to the Master Making Basic Screen. "Size" is updated.

2 Touch [Free].

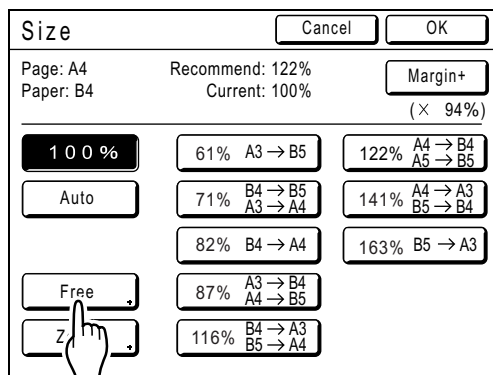

3 Touch or to adjust enlarging/reducing in horizontal or vertical directions.

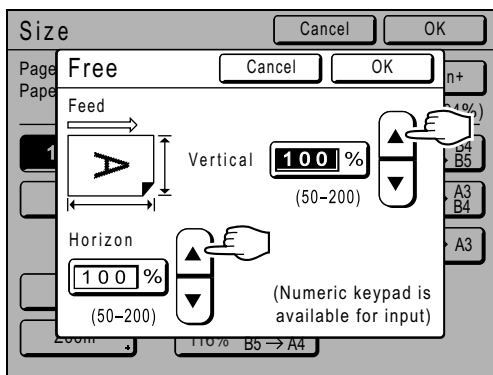

The reproduction size can be increased/decreased in increments of 1%.

Functions for Master-Making

Enlarging and Reducing with the Zoom Function [Zoom]

1 Touch [Size] on the Master Making Basic Screen.

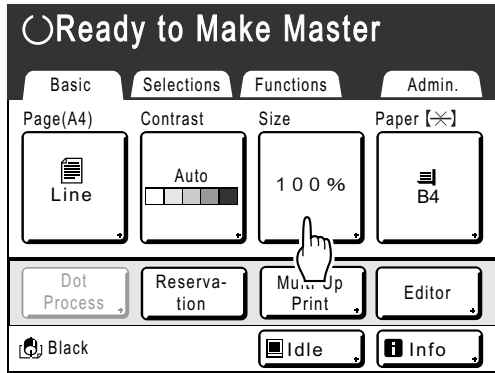

Note:

- Print Quantity Keys can also be used to enter numbers.
- Press the **C** key to restore the original size (100%).

4 Touch [OK].

Returns to the Master Making Basic Screen. "Size" is updated.

2 Touch [Zoom].

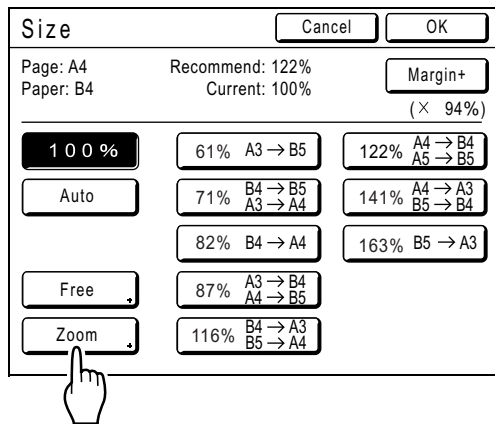

3 Touch  or  to change ratio.

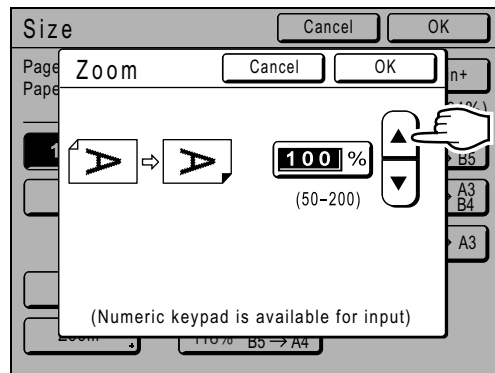

The reproduction size can be increased/decreased in increments of 1%.

Using Custom-Sized Paper [Paper]

The machine automatically detects standard-sized paper in the Paper Feed Tray to create a correct size master for printing. However, because non-standard paper sizes cannot be detected, they must be manually specified before a master can be made.

Important!:

- Custom paper size must be registered on the Admin. screen. Failure to do so may make an incomplete master. [p.170](#)

1 Touch [Paper] on the Master Making Basic Screen.

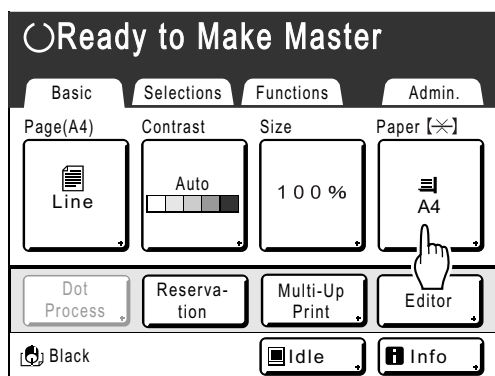

2 Touch the desired paper size.

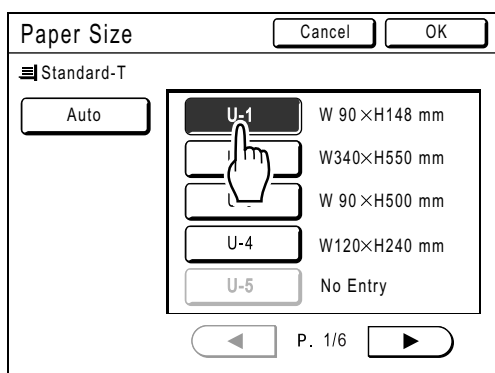

Important!:

- Previously recorded custom paper sizes is displayed on this screen. Make sure to register any custom sizes not displayed here prior to use. [p.170](#)

Note:

- Touch [Auto] to use standard-sized paper.

3 Touch [OK].

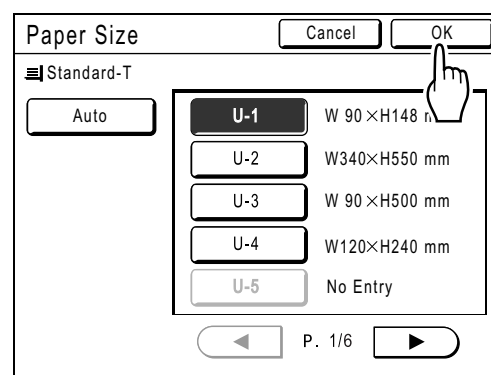

Returns to the Master Making Basic Screen. "Paper size" is updated.

Functions for Master-Making

Automatic Printing [Auto-Process]

Master-making and printing can be performed automatically in sequence.

When "Auto-Process" is selected, simply enter the number of copies to print, then press the  key.

Note:

- When printing is completed, Print Quantity will restore the number originally entered.
- On the Admin. screen, you can make such a setting that "Auto-Process" is always set to ON when you reset or start the machine.

☞ p.159

Press the  key.

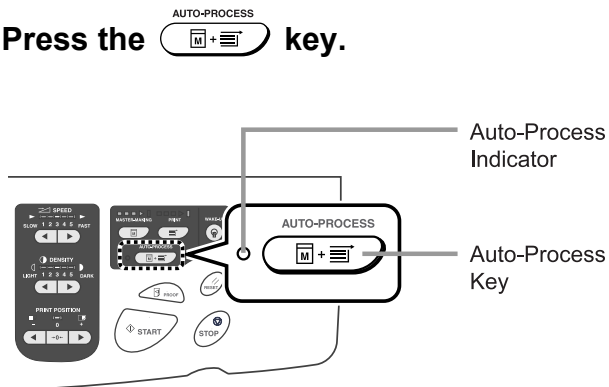

The Auto-Process indicator turns on.

Note:

- To cancel "Auto-Process", press the  key again. The indicator turns off.
- When "Auto-Process" is set to ON and multiple originals are placed in the ADF unit (Option), all originals will be printed automatically.
- When the ADF unit is installed, the default setting for "Auto-Process" is set to ON.

☞ p.159 "Changing Default Settings / OP Auto Process"

Processing Photos with Dot Screen

[Dot Process]

“Dot Process” function processes photo originals with dot screening in order to print more clearly. Select from four types of dot patterns.

Important!:

- “Dot Process” is not available when Image Processing mode has been set to “Line” or “Pencil”.

1 Touch [Functions] on the Master Making Basic Screen.

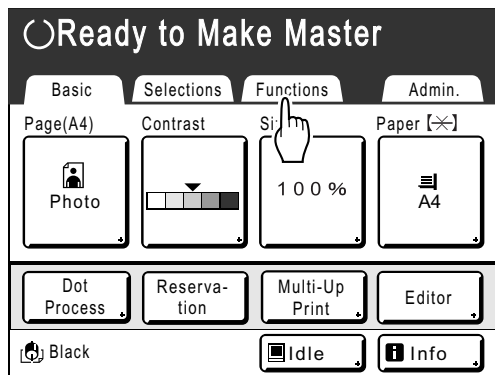

2 Touch [Dot Process].



3 Select a dot pattern.

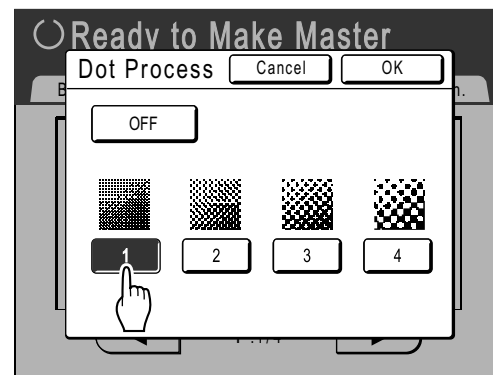

Number	1	2	3	4
Equivalent Lpi	106	71	53	34

Note:

- Touch [OFF] to cancel the “Dot Process”.

4 Touch [OK].

Returns to the Functions screen. “Dot Process” setting is updated.

Functions for Master-Making

Adjusting Photo Contrast [Contrast Adj]

For originals that have ill-defined photos, adjust the contrast to print more clearly. There are two ways to adjust contrast.

Important!:

- If the "Image" is set to "Line", "Duo" or "Pencil", "Contrast Adj" cannot be used.

1 Touch [Contrast Adj] on the Functions Screen.

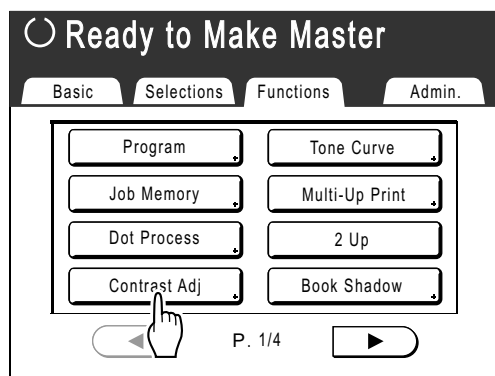

2 Touch the button of the contrast to use.

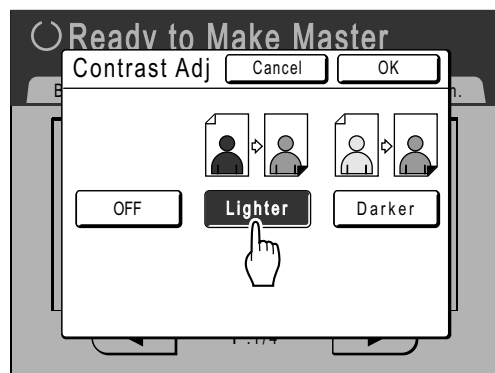

- **[Lighter]:** Lightens dark sections. Use this setting if the entire photo is underexposed and the target subject of the photo is ill-defined.
- **[Darker]:** Clarifies lighter portions. Use this setting if the entire photo is overexposed and the target subject of the photo is ill-defined.

3 Touch [OK].

Returns to the Functions screen. "Contrast Adj" setting is updated.

Adjusting Photo Gradation [Tone Curve]

You can adjust the light and shadow portions of a photo by 3 tones respectively.

Important!:

- If the “Image” is set to “Line”, “Tone Curve” cannot be used.

1 Touch [Tone Curve] on the Functions Screen.

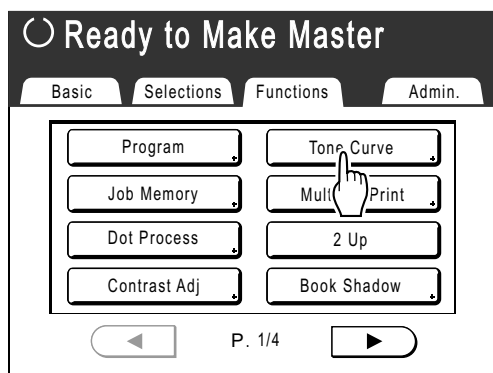

2 Touch the “Lights” and “Shadows” adjustment buttons.

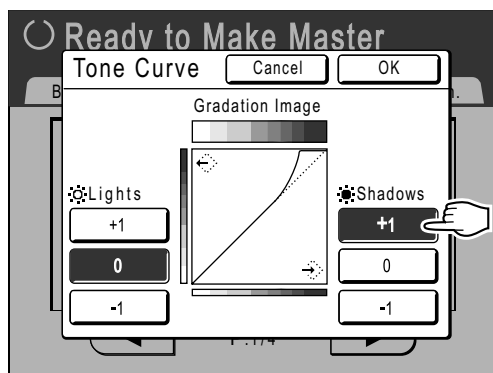

- Lights: Adjusts the portion of the picture most exposed to light.
- Shadows: Adjusts the portion of the picture least exposed to light.

Use [+1] or [-1] to strengthen or weaken each respectively.

3 Touch [OK].

Returns to the Functions screen. “Tone Curve” setting is updated.

Functions for Master-Making

Saving Ink [Ink Saving]

Selecting “Ink Saving” makes a master that requires less ink when printing.

Important!:

- This function is not available at the time of printing. It must be selected before the master-making process is started.
- The ink consumption save process may result in lighter prints than usual.
- “Contrast” and “Print Density Adjustment” functions are not available when “Ink Saving” is selected.
 ☞ p.58
 ☞ p.93

1 Touch [Functions] on the Master Making Basic Screen.

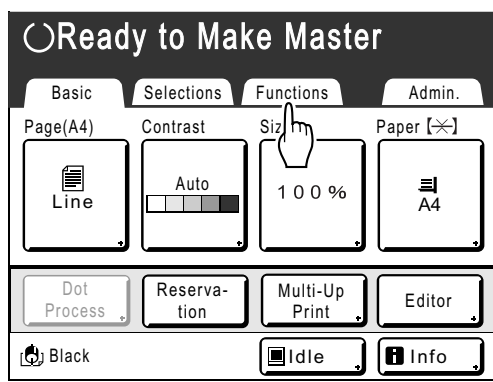

2 Touch [Ink Saving].

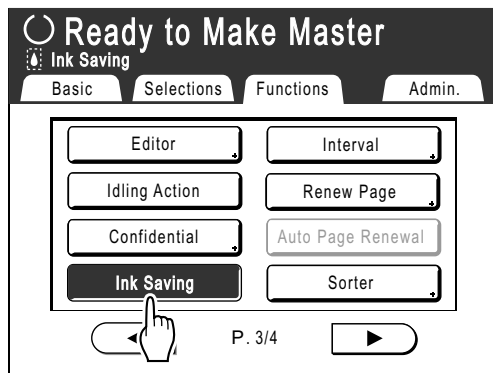

“Ink Saving” is set.

“ Ink Saving” will appear in the message area.

Note:

- “Ink Saving” is a useful function for master-making. Even if this function is set or canceled during printing, it doesn't reflect on the master that is currently rolled around the Print Drum (Cylinder). The setting will be reflected in the next master.
- Even if the “ECO mode” is selected, a  mark appears in the message area of the basic screen.

Printing Multiple Originals on One Sheet

[2 Up] [Multi-Up Print]

“Multi-Up” function prints multiple originals on one sheet.

◆ 2 Up

Prints two copies of the same original side-by-side on one sheet of paper.

Note:

- Using the ADF unit (Option), two different originals can be printed side-by-side on one sheet of paper.

◆ Multi-Up Print

One or multiple originals (up to 4) can be printed on a single sheet of paper.

The border lines between the originals (shadows) will not be printed and you can get a clearer copy.

“Multi-Up Print” has the following three types:

- Single-Original: A single original is printed multiple times.
 - Multiple-Original: Multiple originals are printed multiple times.
 - Multi-Up Tickets: You can print multiple long, thin custom originals such as tickets.
- Single-Original and Multiple-Original can print in quantities of 2, 4, 8 and 16 respectively.

Important!:

- Use standard-sized paper when using the “Multi-Up” function. With custom-sized paper placed, you cannot perform “Multi-Up” printing even when the size is stored on the Admin. screen.

Note:

- “2 Up” and “Multi-Up Print” functions cannot be used with the following functions.
 - Auto-Link (This function is not available for EZ591U)
 - Top Margin
 - Book Shadow
 - Side Margin
 - Size (Auto)
 - Format (Auto) (in Scan Mode)
- If you change the “Image” setting between originals in Multiple-Original, you cannot use “Ink Saving”.

Functions for Master-Making

Original Orientation and Print Results

The orientation of the original differs depending upon the number of images. The orientation and print results for each possibility is shown below.

2 Up

Prints two copies of the same original side-by-side on one sheet of paper.

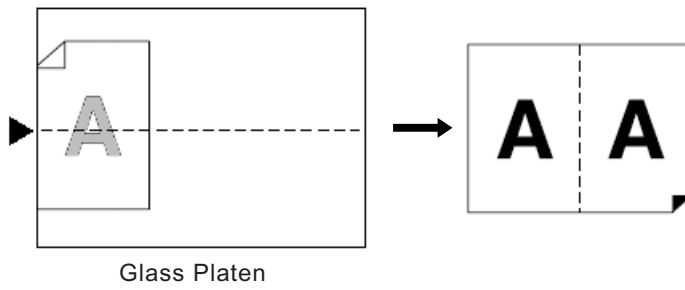

Multi-Up Print

For Single-Original and Multiple-Original:

Note:

- When "Multiple-Original" is used in Multi-Up Print, the actual number of pages to be scanned is specified. In the case that the actual number of pages in the document is less than the number of pages specified in the mode settings, set an equivalent number of blank pages in the machine to make up for the specified number. (For example, if you want to make eight pages and there are only three originals, add a blank page to the originals and set the four sheets for scanning.)

◆ 2 Up (2 on 1)

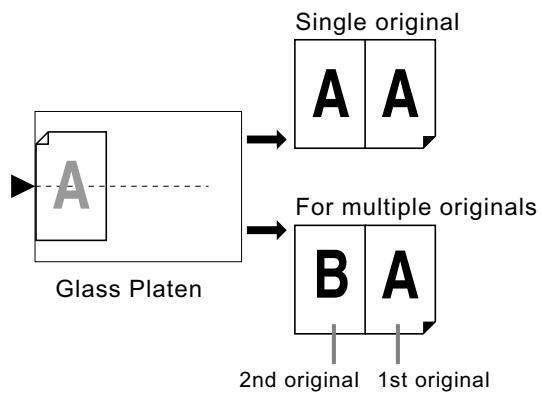

Up to 2 originals can be scanned.

◆ 4 Up (4 on 1)

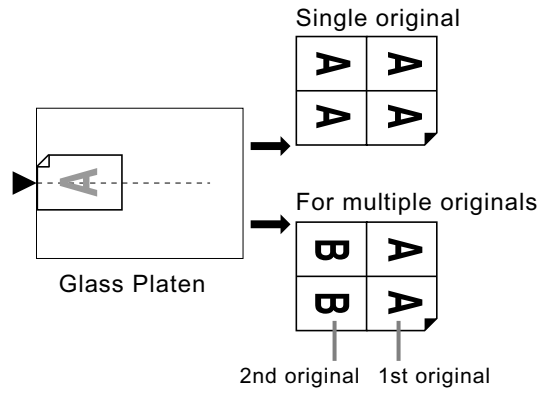

Up to 2 originals can be scanned.

◆ 8 Up (8 on 1)

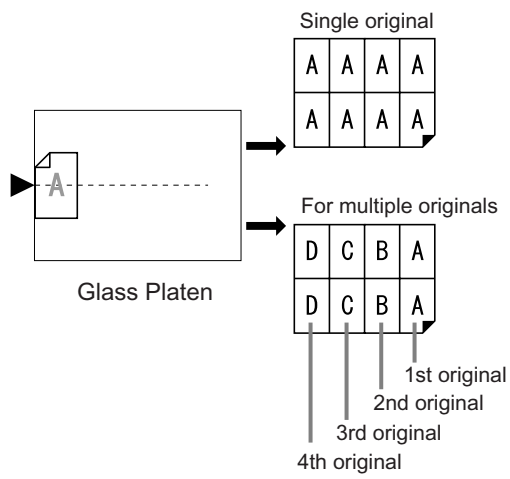

Up to 4 originals can be scanned.

Functions for Master-Making

◆ 16 Up (16 on 1)

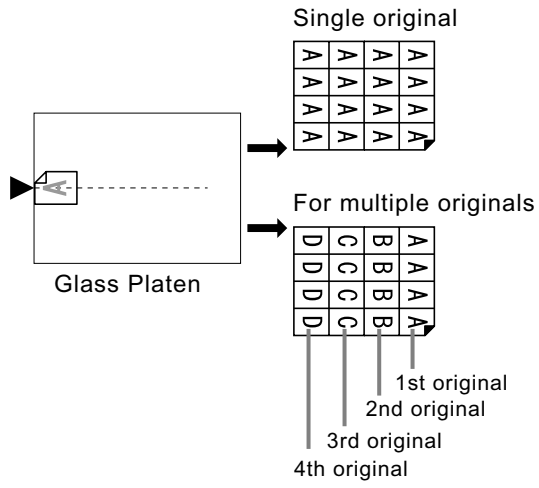

Up to 4 originals can be scanned.

◆ For Multi-Up Tickets:

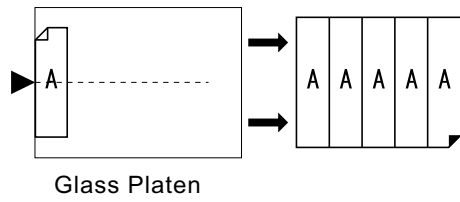

“Multi-Up Tickets” cannot be used with multiple originals.
The number of images printed is determined by the width of the ticket.

Margin

Leave a margin of at least 5 mm ($\frac{3}{16}$ ") on the top edge of the Glass Platen or the ADF unit (Option). Allowing a proper margin is critical in well-balanced Multi-Up positioning.

☞ p.18

Note:

- A margin on the top edge will remain regardless of enlargement or reduction settings.

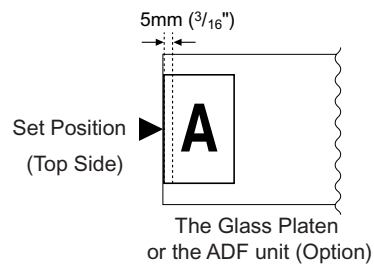

Orientation of Print Paper

Always place paper in the Paper Feed Tray as shown below.

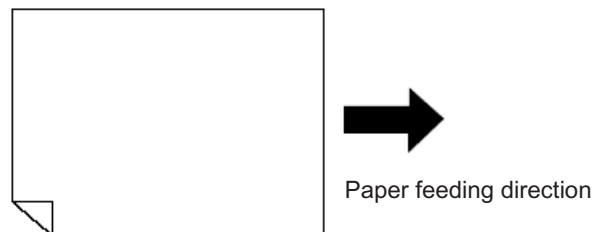

Multi-Up Interval

"Multi-Up" performs scanning for the number of sheets.

The interval between the first scan and the second scan is called "Multi-Up Interval".

Replace originals or change settings for the second scan during the "Multi-Up Interval".

Note:

- Default "Multi-Up Interval" can be set on the Admin. screen. The factory default is 15 seconds. ☞ p.161

Functions for Master-Making

2 Up Operation

1 Set the original and print paper.

Important!:

- Pay attention to the orientation of the original. For “2 Up”, make sure to place the original as shown below. The same is true when using the ADF unit (Option).

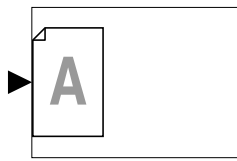

- Make sure to load paper as shown below.

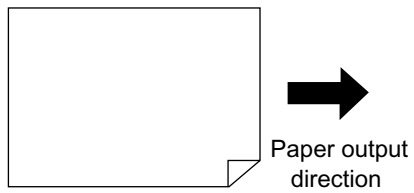

Note:

- With the ADF unit (Option) you can print two different originals side by side on a single sheet of paper (2 in 1 printing). Set the two originals one above the other.
- To print two copies of the same original side by side on a single sheet of paper (2 Up printing), set the original on the Glass Platen.

2 Touch [Functions] on the Master Making Basic Screen.

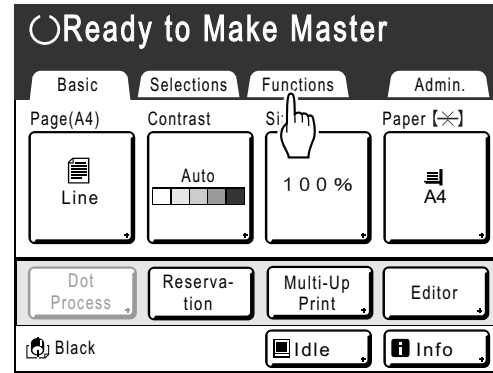

3 Touch [2 Up].

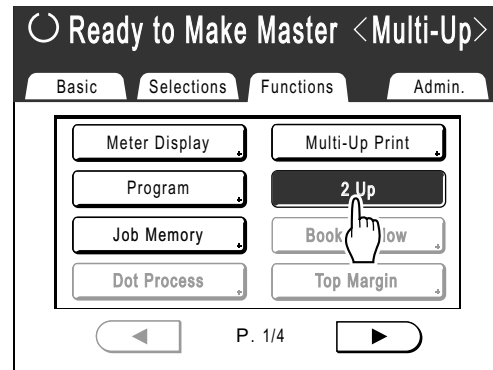

4 Make necessary settings.

Make various settings as needed.
The enlarging/reducing needs to be set depending on the combination of the original size and printing paper size.

		Original			
		A4	B5	A5	B6
Printing Paper	A3	100%	116%	141%	163%
	B4	87%	100%	123%	142%
	A4	71%	82%	100%	116%
	B5	61%	71%	87%	100%

		Original			
		A6	B7	A7	B8
Printing Paper	A3	200%	---	---	---
	B4	173%	200%	---	---
	A4	138%	163%	200%	---
	B5	122%	141%	173%	200%

		Original	
		Letter	Statement
Printing Paper	Ledger	100%	155%
	Legal	82%	127%
	Letter	65%	100%
	Statement	50%	77%

5 Press the key.

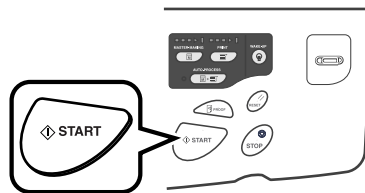

Starts scanning of the original.

Functions for Master-Making

Operation for Multi-Up Printing

1 Set the original and print paper.

Important!:

- Pay attention to the orientation of the original. [p.70](#)
- Make sure to load paper as shown below.

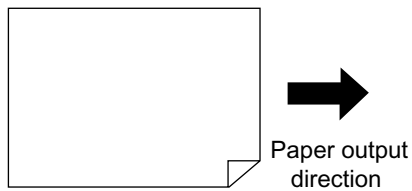

Note:

- It is convenient to place all originals in the ADF unit (Option) when using the “Multiple-Original” mode. [p.37](#)

2 Touch [Functions] on the Master Making Basic Screen.

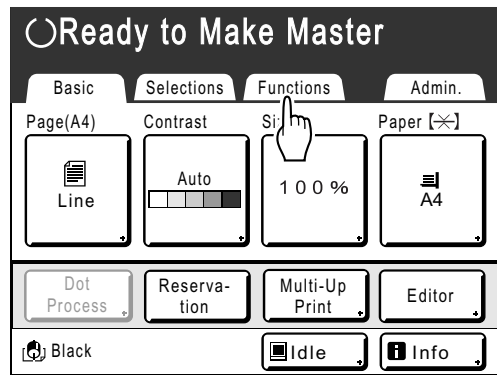

3 Touch [Multi-Up Print].

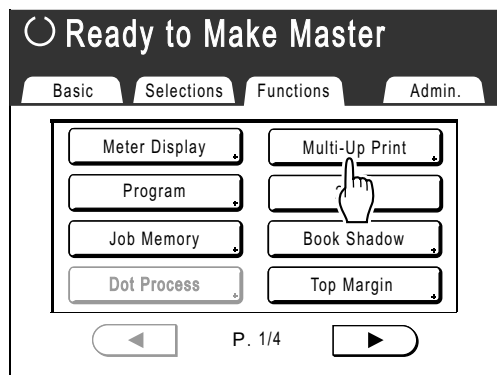

4 Select a Page size to use.

Touch the button to match the original size and touch **[Next>]**.



The enlarging/reducing is automatically set and the Multi-Up Print screen is displayed.

5 Touch [Single] for Single-Original, touch [Multiple] for Multiple-Original.

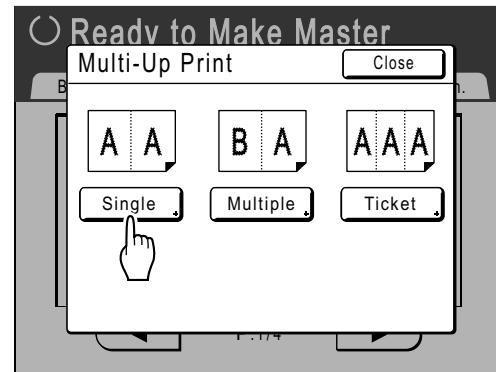

Except for the original placement method, operations for “Single-Original” and “Multiple-Original” are basically the same. This example is for “Single-Original”.

6 Touch the button of the number of images to use.

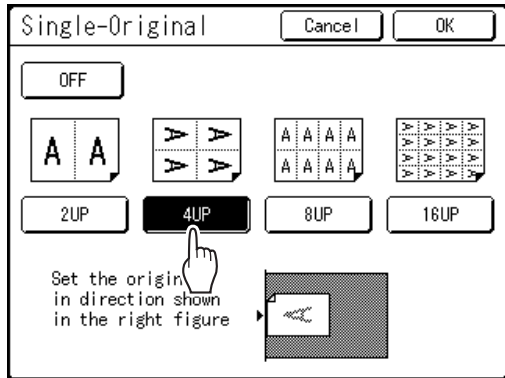

To cancel the "Multi-Up Print" settings or return to the Functions screen, touch **[Cancel]**.

7 Touch [OK].

Returns to the Functions screen. "Multi-Up Print" setting is updated. The reproduction size is automatically set according to the selected number of images based on the paper size and original size to use.

8 Make necessary settings.

- Make various settings as needed.
- When the reproduction size is set before setting Multi-Up Print, the reproduction size is invalidated and changes to the size setting suitable for the selected number of images.
 - The image of the 2nd original and subsequent originals can be changed to something different from the image of the 1st original.

9 Press the  key.

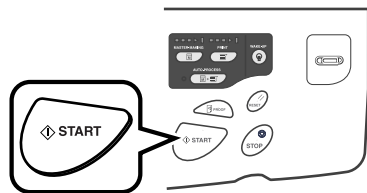

Scanning of the original starts. After scanning has finished, follow the usual steps to print.

Important!:

- After displaying the message, "Place Another Original and Press Start Key To Cancel, Press Stop Key" the machine waits for the next original to be loaded. Set the next original and press the  key while waiting (interval)

time. Press the  key to cancel the "Multi-Up Print" mode.

- The Glass Platen and the ADF unit (Option) cannot be used at the same time. If using the Glass Platen to scan the first sheet of the original, you must continue to use the Glass Platen to scan the rest of the original.
- To scan the original with the optional ADF unit and use the "Single-Original", you need to set the original twice.

Note:

- When "Multiple-Original" is used in Multi-Up Print, the actual number of pages to be scanned is specified. In the case that the actual number of pages in the document is less than the number of pages specified in the mode settings, set an equivalent number of blank pages in the machine to make up for the specified number or press the  key in the status of waiting for the next original. Master-making starts.
→ p.70 "Original Orientation and Print Results"
- When using the "Auto Process" setting, printing will continue automatically when originals are set in the ADF unit (Option).
- To cancel a "Multi-Up Print" setting once it has been confirmed, follow steps 2 and 3, touch **[OFF]** and then **[OK]** on the screen.

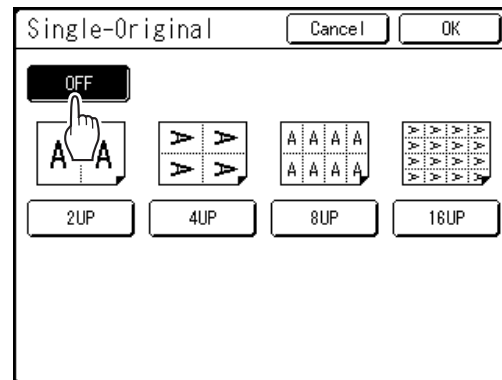

Functions for Master-Making

Operation for Multi-Up Tickets

For "Multi-Up Tickets", the specification of the short edge size of the original (the width) is used to calculate the number of images that can be printed on one sheet of paper (long edge of the print paper divided by ticket width). A ticket width of between 50 mm (1³¹/₃₂") and 210 mm (8¹/₄") can be specified.

Ex.)

Ticket width 50 mm (1³¹/₃₂")

Long edge of the print paper 297 mm (11¹¹/₁₆") (A4 size)

297÷50=5 with a remainder of 47

In this example, 5 images print on one sheet of paper.

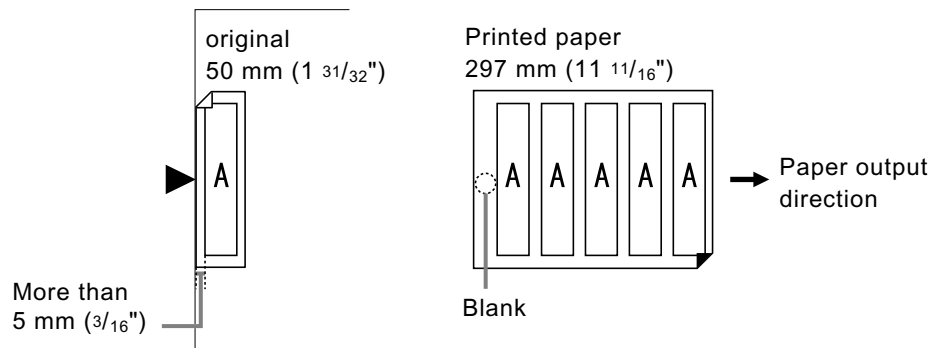

1 Set the original and print paper.

Place the original on the Glass Platen.

Important!:

- Pay attention to the orientation of the original.
☞ p.70
- Make sure to load paper as shown below.

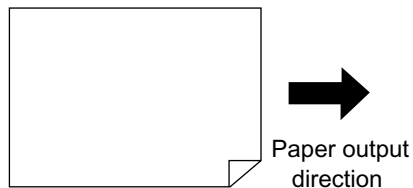

2 Touch [Functions] on the Master Making Basic Screen.

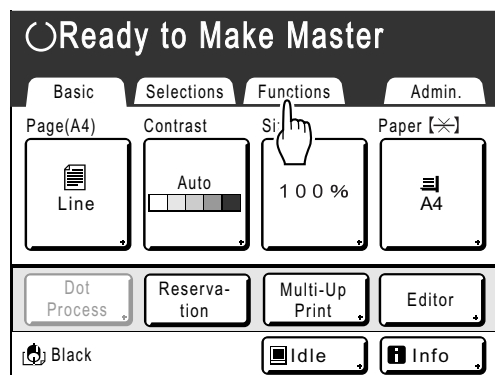

3 Touch [Multi-Up Print].

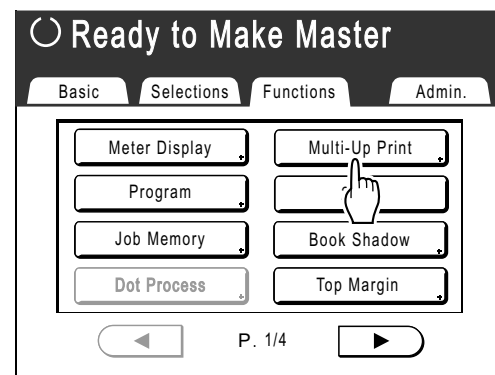

4 Select a Page size.

Touch either one of the Page size button and touch **[Next>]**.
(In "Multi-Up Tickets", the Page Size selection will not affect the rest of the procedures.)



The Multi-Up Print screen is displayed.

5 Touch [Ticket].

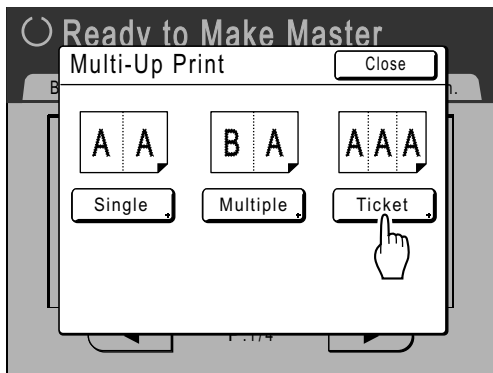

6 Touch [ON].

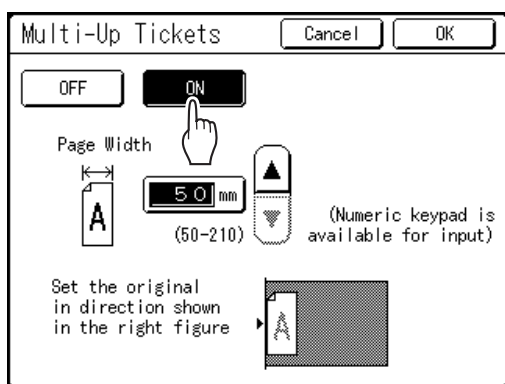

You can specify the "Page Width".

7 Touch  or  to specify the short edge size of the original (the width).

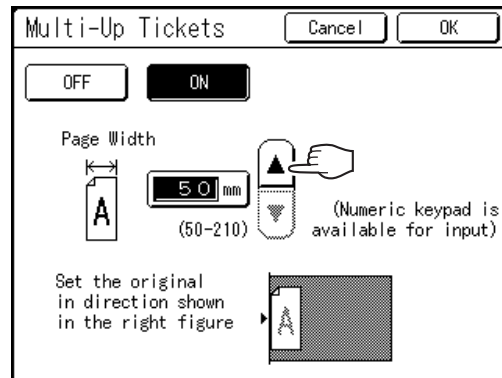

Important!:

- If you have enlarged/reduced size in step 9 (setting print functions), be careful about the following points.
 - Specify the ticket width after enlarging/reducing.
 - If you enlarged the size, make sure that the bigger size does not exceed the specified "Page Width" or the short edges of the print paper.
 - When enlarging, make sure to prepare paper that fits the enlarged size.

8 Touch [OK].

Returns to the Functions screen.
"Multi-Up Tickets" setting is updated.

9 Make necessary settings.

Make various settings as needed.

10 Press the  key.

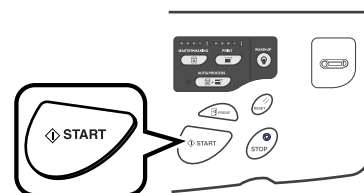

Starts scanning of the original.
After this, please follow the same operations for normally printing.

Functions for Master-Making

Note:

- To cancel a "Multi-Up Print" setting once it has been confirmed, follow steps 2 and 3, touch **[OFF]** and then **[OK]** on the screen.

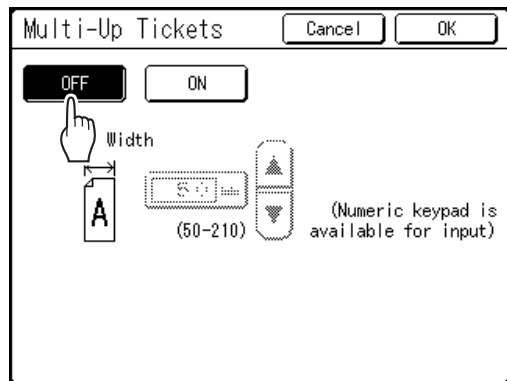

Printing from Bound Documents

[Book Shadow]

You can erase the binding “spine” shadow in the center when printing from such bound originals with facing as magazines and books.

The area to be erased (erasure width) can be selected.

Moreover, magazines or books can be spread open on the Glass Platen and their pages printed onto separate sheets.

Important!:

- The original must be placed aligning center on the Glass Platen as shown below. When erasing the binding shadow or printing an original onto separate sheets by splitting the pages, set the original in the direction of A.

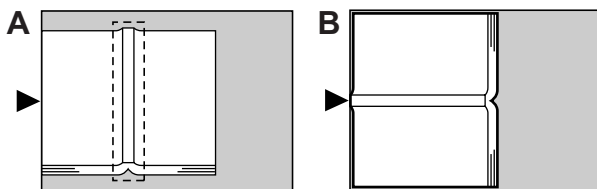

- The following image areas are also erased (or half-toned).
 - A continuous black image area (non-white) from the edge of the original

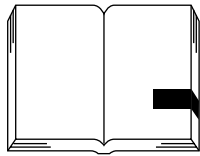

- A continuous black image area from the center of the original

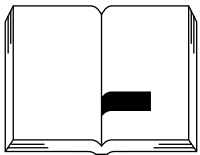

Note:

- Book Shadow function cannot be used with the following functions.
 - Binding margin
 - Ink Saving
 - Scanning Contrast ([Auto])
 - Multi-Up Print
- If you use the “Book Shadow” with the Gauge Cover installed, the surrounding image gets black on the master. If the Gauge Cover is installed, remove the Gauge Cover and then use the “Book Shadow”.
- If you are scanning a thick book such as an encyclopedia, raise the hinge of the glass platen cover and press down for best results.

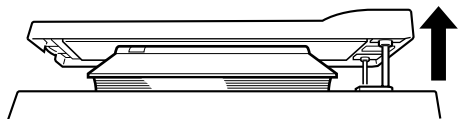

Functions for Master-Making

1 Touch [Functions] on the Master Making Basic Screen.

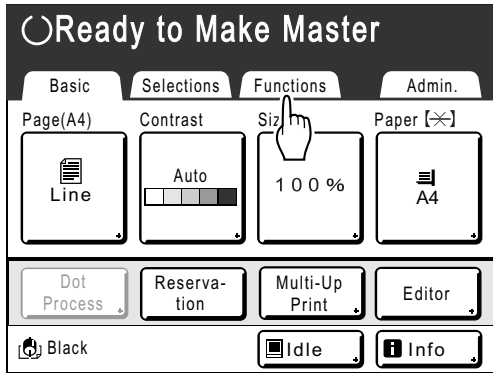

2 Touch [Book Shadow].

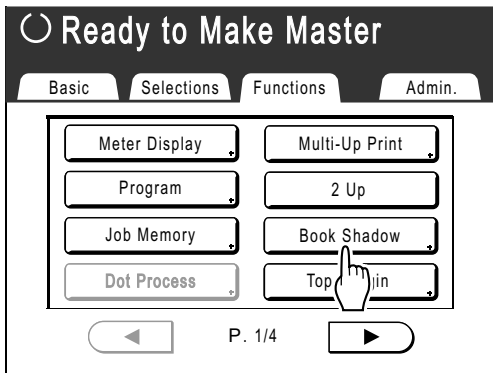

3 Touch [Erase] or [Halftone] for "Process".

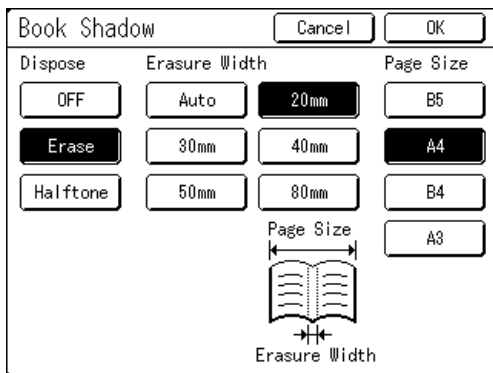

- **[OFF]:** Book Shadow is not performed.
- **[Erase]:** Erases shadows near the center and around the original.
Select the size of spread original from "Page Size".
- **[Halftone]:** Photo processes the center shadow for a natural feel and deletes shadows that it can around the original.

4 Touch [Erasure Width] and [Page Size].

- If you set "Process" to "Halftone", you can only select "Auto".
- If you set "Erasure Width" to "Auto", original detection is performed automatically, and the erasure width is calculated from the detected size.
- If you specify the erasure width, original detection is not performed automatically. Touch [Erasure Width], and then touch the [Page Size] for the magazine or book you have placed.

5 Touch [OK].

Returns to the Functions screen. "Book Shadow" setting is updated.

Cutting the Top Margin of the Original and Printing [Top Margin]

You can cut the top portion of the margin to between 0 to 99 mm (0" to 3⁷/₈") and make a master. This feature enables you to skip the registration marks* on the original and print on the finish-sized paper without any of these marks.

A margin on the paper periphery is required even if you use "Top Margin" function.

☞ p.18

*** About the Registration Mark**

In the field of commercial printing, it is normal to print on paper that is larger than the finished size and then cut down to the finished size afterwards. The symbol that indicates the position to cut in this event is known as the registration mark.

Important!:

- When you are setting the "Size", magnify / reduce using the area that skips the set value.
- Do not use "Auto Reproduction Size".
- This function cannot be used with "Multi-Up Print" and "2 Up".

1 Place an original.

Place the original face down on the Glass Platen. Align center on the top edge, and close Platen Cover.

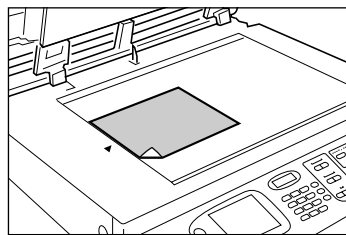

2 Touch [Functions] on the Master Making Basic Screen.

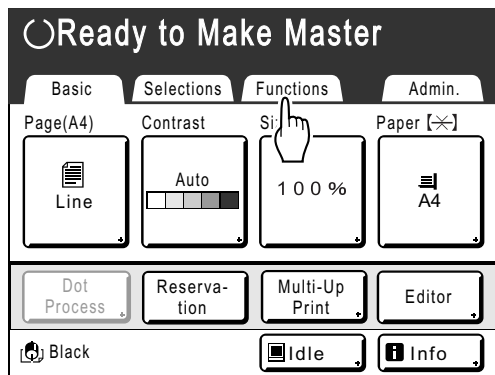

3 Touch [Top Margin].

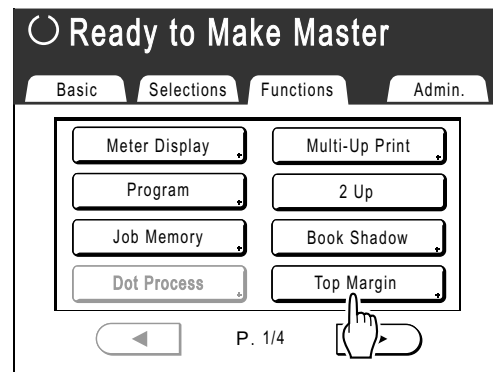

4 Touch [ON].

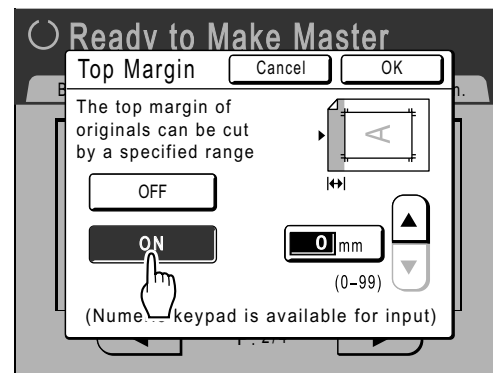

Functions for Master-Making

- 5 Touch  or  to specify the cut width.

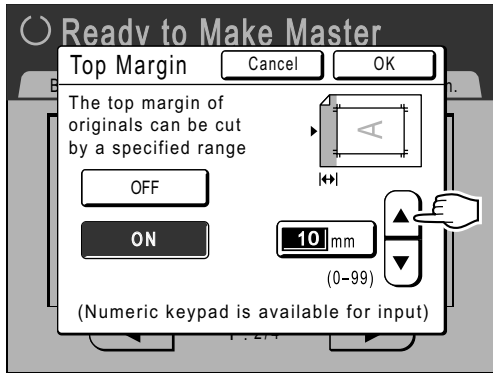

You can set from 0 to 99 mm (0.0" to 3.9").

Note:

- Print Quantity Keys can also be used to enter numbers.

- 6 Touch [OK].
Returns to the Functions screen.
"Top Margin" setting is updated.

Adjusting the Side Margins of the Master

[Side Margin]

If you are using the ADF unit (Option) to print multiple originals and need to move the left and right margins to make a master, use "Side Margin" for one simple operation to offset the margins for all the originals (up to 10 mm ($13/32$ " left/right)).

Important!:

- The "Side Margin" function shifts the location of the original to the right or left. It does not reduce the size of the original.
- By using "Side Margin", the opposite side of the side margin may be pushed out of the print area and not print. Check the margins of the original prior to setting.
- This function cannot be used with the following functions.
 - Multi-Up Print
 - 2 Up
 - Overlay

Note:

- This function can be used to set the side margins even when the original is set on the Glass Platen.

1 Touch [Functions] on the Master Making Basic Screen.

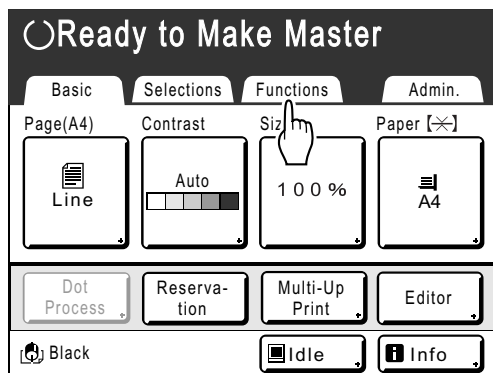

3 Touch [Left] or [Right] to adjust.

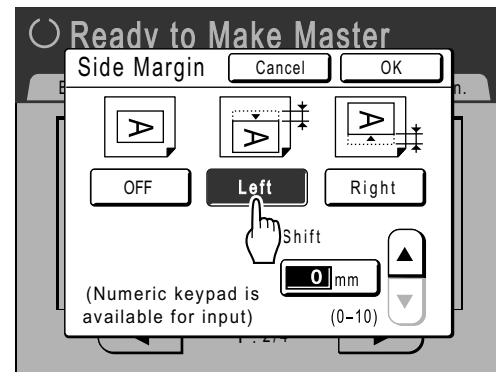

2 Touch [Side Margin].

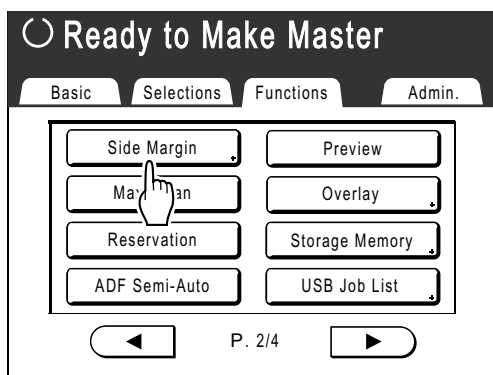

4 Touch ▲ or ▼ to specify the shift distance.

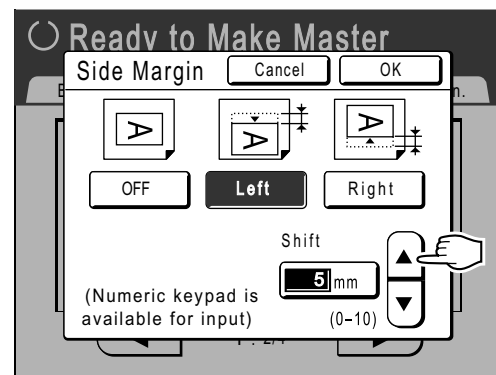

You can set from 0 to 10 mm (0" to $13/32$ ").

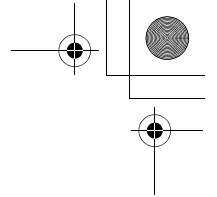

Functions for Master-Making

Note:

- Print Quantity Keys can also be used to enter numbers.

5 Touch [OK].

Returns to the Functions screen.
"Side Margin" setting is updated.

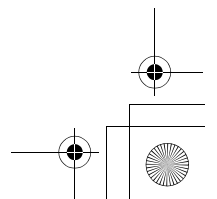
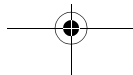
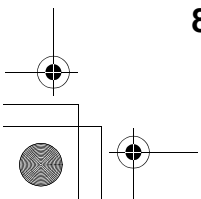
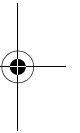
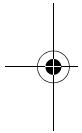

Checking the Print Image Prior to Making Master [Preview]

You can check what the actual master will look like by previewing an image of the scanned original or an image of data sent from a computer. This function is handy for checking the layout or final image of a Multi-Up job. The operation and display timing differ depending upon the mode.

Mode name (original type)	When set	When to display	If "Auto Processing" is ON
Printing from the Original Document	When setting functions related to Master Making (settings from Functions)	After Scanning the Original	Scans the original, then temporarily stops to display preview.
Scan Mode	When setting functions (master making functions) related to Scanning (setting from Functions)	After Scanning the Original	When in scan mode, an original is scanned and then saved, so there is no "Auto Process" operation. However, if multiple originals are placed in an ADF unit (Option), you can touch [Close] after reviewing the preview to start the scan of the next original.
Printing Original Data from a Computer	Stopping the print job prior to making a master (Pause before "Master"/Auto Process OFF), after the machine has received the original data	Displays when touching [Preview]	A preview is not shown if data is sent from the printer driver with "Auto-process".
Retrieving Stored Data and printing	When retrieving stored data (set on the Storage Basic Screen).	Displays when touching [Preview]	If you touch [Preview] , it displays immediately.

Note:

- Preview shows an image oriented towards output after printing.
- It shows the scanned original as-is. A margin is required when actually printing. Check to make sure that the margins are sufficient.
- In "Direct Print" operation, **[Preview]** will be displayed on the Master Making Basic Screen when data is received from the computer.
p.44
- When in Link mode (when a Linked Printer is connected), the original image after scanning and prior to output from the Linked Printer is previewed.

Functions for Master-Making

Actions Available on the Preview Screen

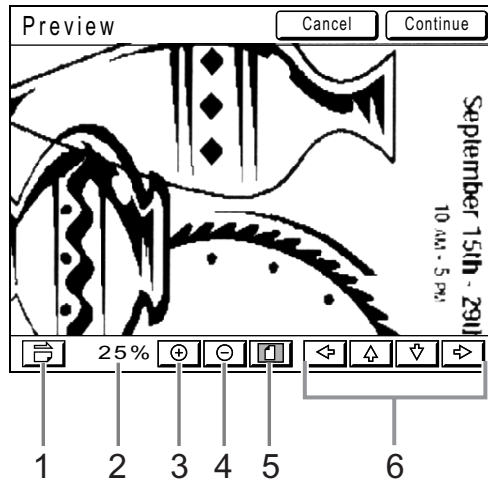

- | | |
|----------------------------------------------------------------------------------------------------------------------------------------------------------------------------------------------------------------------------------------------------|--------------------------------------------------------------------------------------------------------------------------------------------------------------------------------------------------------------------------------------------------------------|
| <p>1) Rotate Image Button
Allows you to rotate the displayed image 90 degrees.</p> <p>2) Displays the size of the current display.</p> <p>3) Enlarge Button
Enlarges the preview display each time it is touched.</p> | <p>4) Reduce Button
Reduces the preview display each time it is touched.</p> <p>5) Show All Button
Shows the entire image.</p> <p>6) Scroll Button
The image in the display screen moves in the direction of the arrow.</p> |
|----------------------------------------------------------------------------------------------------------------------------------------------------------------------------------------------------------------------------------------------------|--------------------------------------------------------------------------------------------------------------------------------------------------------------------------------------------------------------------------------------------------------------|

Operation for Preview

The operational procedures for "Printing from the Original Document" are explained below.

- 1 Place an original.**
p.40
- 2 Touch [Functions] on the Master Making Basic Screen.**
- 3 Touch [Preview].**

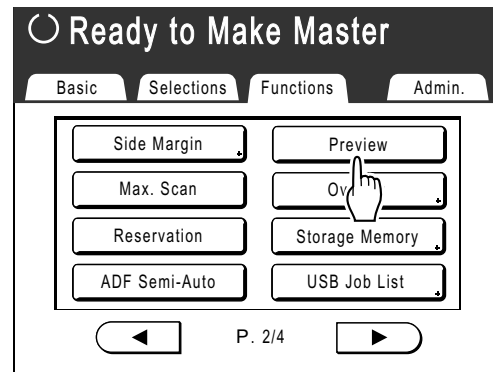
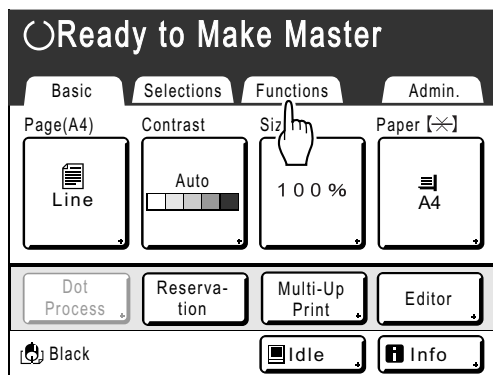

"Preview" setting is updated.

4 Make necessary settings.

You can configure print functions to apply to the new original as needed.

5 Press the  key.

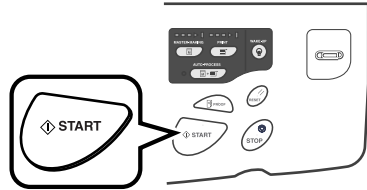

A scan of the original begins, and can be previewed on the Preview screen.

6 Check the preview image.

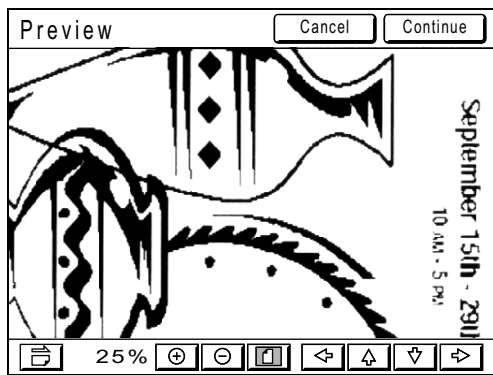

You can use various controls on this screen to check the image.
 p.88

7 Touch [Continue].

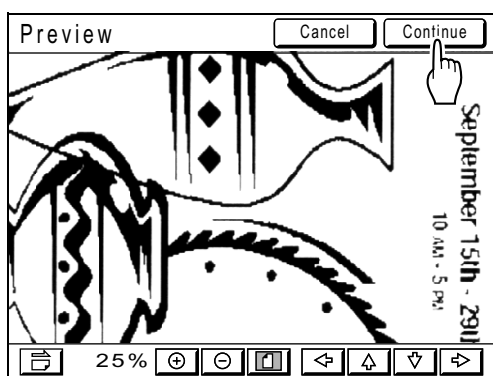

A master is created.
 After this, follow the same operations for normally making a master.

Note:

- Touching **[Cancel]** will cancel the image, returning to the Master Making Basic Screen. To resume preview operation, repeat from step 4.

Functions for Master-Making

Making a Master that Utilizes the Maximum Printing Area [Max. Scan]

When a master is made, automatic paper size detection and image size adjustment applies to allow appropriate print margins. This is to prevent paper jams, and to keep internal roller free of ink stains.

By selecting "Max. Scan", maximum printing area will apply to the scanned image, regardless of the print paper size or original document size.

Be sure to check the sizes of the original document and the printing paper first.

☞ p.18

◆ Maximum printing area

EZ591: 291 mm × 425 mm (11⁷/₁₆" × 16³/₄")

EZ571: 291 mm × 413 mm (11⁷/₁₆" × 16¹/₄")

EZ531: 251 mm × 357 mm (9⁷/₈" × 14¹/₁₆")

Important!:

- The 5 mm (³/₁₆") margin on the top cannot be scanned even in the "Max. Scan" setting.
- Do not use print paper smaller than the area of the image made on the master. This may cause ink stains.
- The entire surface of the Glass Platen must be clean.
By scanning the maximum size, dirt found outside the original document area will also be included in the master. This may cause the internal roller to be stained with ink.

1 Touch [Functions] on the Master Making Basic Screen.

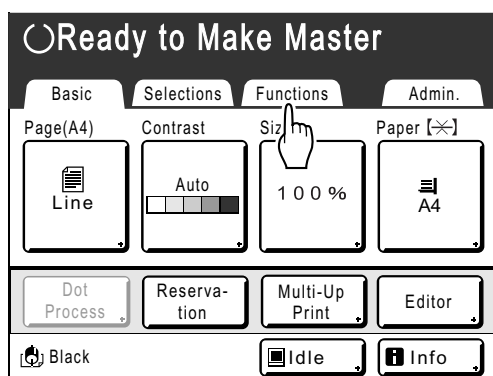

2 Touch [Max. Scan].

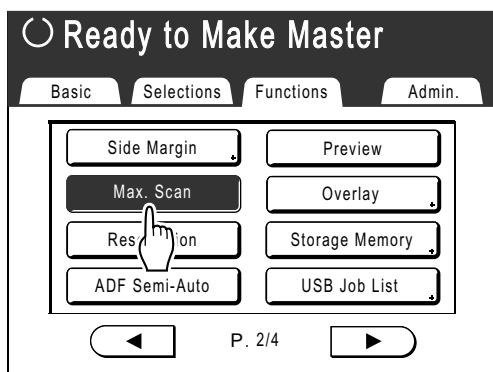

"Max. Scan" is selected.

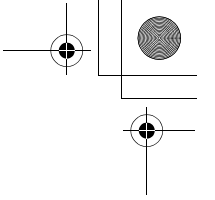

Functions for Master-Making

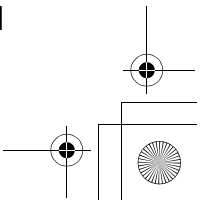
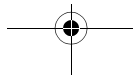
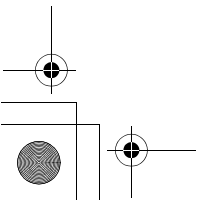
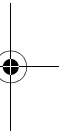
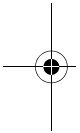

Functions for Printing

Changing the Print Speed

[Print Speed Adjustment]

You can select the print speed from five levels; from 60 to 130 pages/minute. The print speed may be changed while printing is in progress.

Note:

- The default print speed can be set on the Admin. screen. The factory default is level 3 (approximately 100 pages/minute).
p.159
- When the “ECO mode” is selected, the initial setting for the print speed is set to “3”. The print speed can be adjusted even while the ECO mode is set to “ON”.

Press the ◀ or ▶ key to change the print speed.

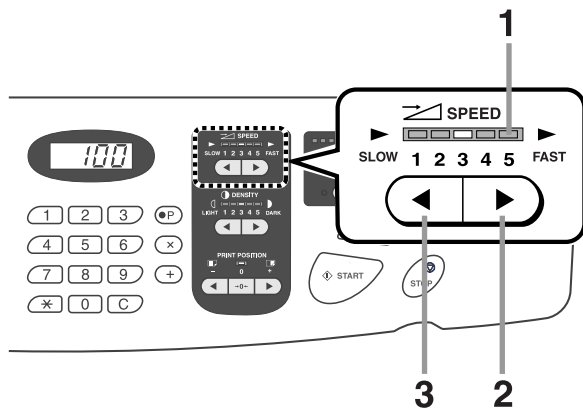

- 1) Print Speed Adjustment Indicator**
Shows the current print speed.
- 2) ▶ Key**
Increases the print speed incrementally.
- 3) ◀ Key**
Decreases the print speed incrementally.

Indicator level and print speed

Indicator Level	1	2	3	4	5
Print Speed (pages/minute)	Approx. 60	Approx. 80	Approx. 100	Approx. 120	Approx. 130

Adjusting the Print Density

[Print Density Adjustment]

You can select the print density from five levels.
The print density may be adjusted while printing is in progress.

Important!:

- “Print Density” is not available when **[Ink Saving]** is selected.
☞ p.68

Note:

- The default print density can be set on the Admin. screen.
The factory default is set at level 3 (Standard).
☞ p.159
- When the “ECO mode” is selected, the initial setting for the print density is set to “1”.
The print density can be adjusted even while the ECO mode is set to “ON”.
☞ p.162 “Changing Default Settings / Print Density Standard/ ECO mode”

Press the ◀ or ▶ key to adjust the print density.

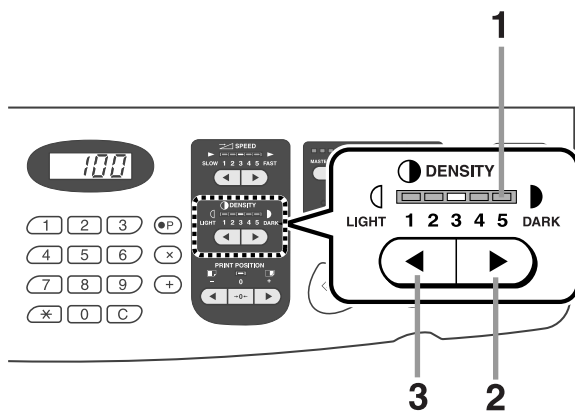

- 1) **Print Density Adjustment Indicator**
Shows the current print density.
- 2) **▶ Key**
Increases the print density incrementally.
- 3) **◀ Key**
Decreases the print density incrementally.

Functions for Printing

Adjusting the Print Position

[Print Position Adjustment]

Use the Vertical Print Position Adjustment keys to adjust the print position in the vertical direction; and use the Horizontal Print Position Adjustment Dial (located on Paper Feed Tray) to adjust it in the horizontal direction.

Adjustment range Vertical direction: $\pm 15 \text{ mm}$ ($\pm 19/32''$) Horizontal direction: $\pm 10 \text{ mm}$ ($\pm 3/8''$) *

The vertical positioning may be adjusted while Printing is in progress.

*For paper of widths over 297 mm ($\pm 11 1/16''$), the adjustment range in the horizontal direction becomes smaller than $\pm 10 \text{ mm}$ ($\pm 3/8''$).

Important!:

- After adjusting the print position, print a proof copy to check the result.
☞ p.96

Vertical (Up/Down) Adjustment

Press the ◀ or ▶ key to move up or down.

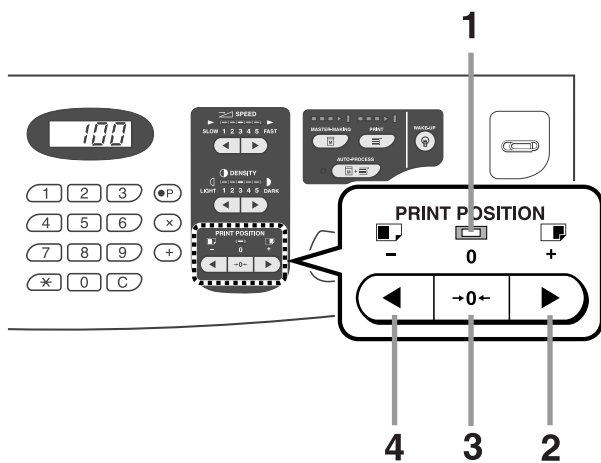

- 1) Center Position Indicator**
Indicates when vertical positioning has not changed.
- 2) ▶ Key**
Each press shifts the print position upward in steps of about 0.5 mm ($1/64''$).

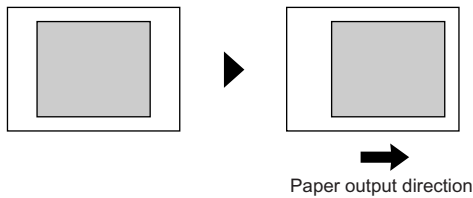

- 3) ←0→ Key**
Press to return to original position.
To restore the original Print Position during printing, hold the button down for more than 1 second. When the original Print Position is restored the indicator will light up.

- 4) ◀ Key**
Each press shifts the print position downward in steps of about 0.5 mm ($1/64''$).

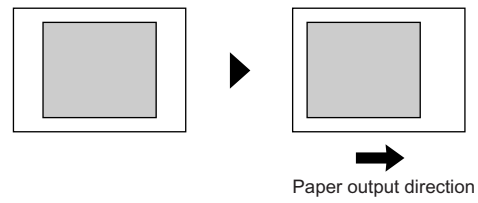

The Print Basic Screen shows current vertical adjustment.

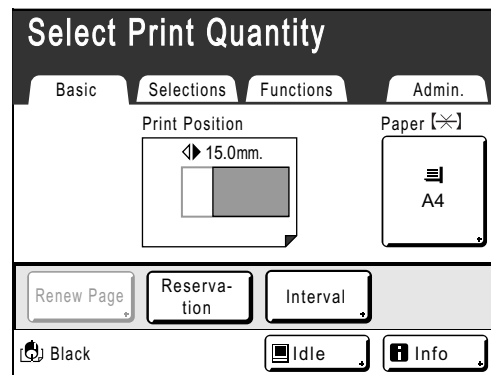

Horizontal (Left/Right) Adjustment

1 Press the Feed Tray Ascent/Descent Button to lower the Paper Feed Tray.

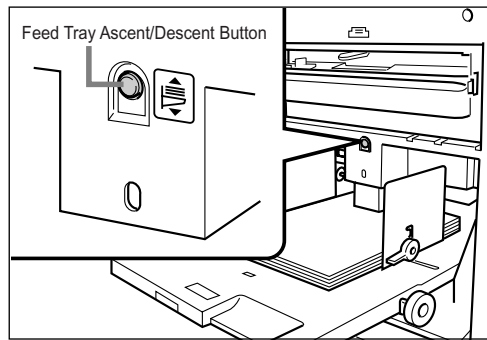

2 Turn the Horizontal Print Position Adjustment Dial to move horizontally (left or right).

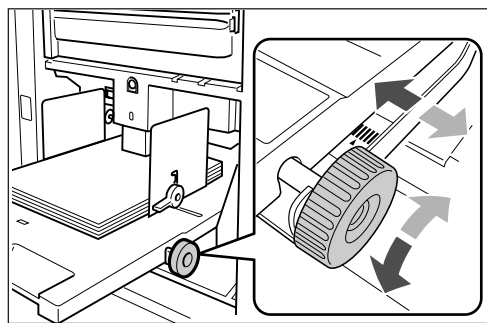

◆ Turning clockwise

Paper: moves to right
Print Position: moves to left

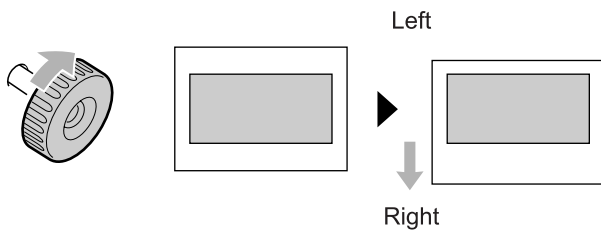

◆ Turning counter-clockwise

Paper: moves to left
Print Position: moves to right

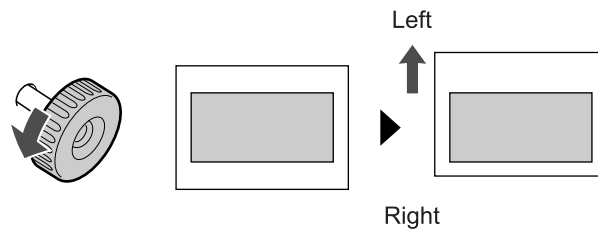

Check the amount of offset from the center by looking at the gauge beside the Paper Feed Tray. (Horizontal adjustment cannot be checked on the Display.)

▲ indicates center on the gauge. Press the  key to verify positioning by proof copy.

Important!:

- Be sure to adjust the Receiving Tray Paper Guides after moving left or right. [p.35](#)
- Be sure to re-position the Paper Feed Tray to center after printing is completed.

Functions for Printing

Printing Proof Copies [Proof]

After making adjustments to the print position or density, check the print quality in a proof copy. Proof copies are not counted towards the number of copies displayed on the Print Quantity Display.

Note:

- The machine will continue to print proof copies if the  key is held down.
- A proof copy cannot be printed from a Linked Printer.

Press the  key.

A single proof copy is printed.

Print Quantity Display

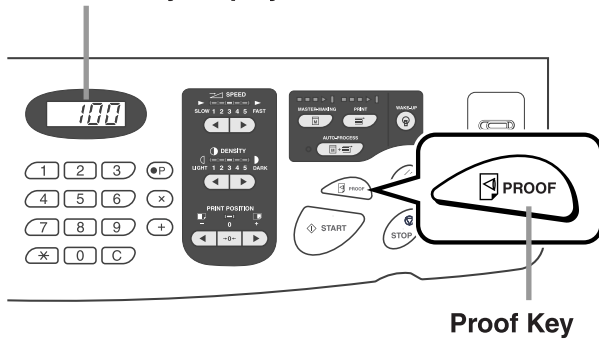

Extending the drying time [Interval]

A sheet of paper is normally fed and printed with each drum (cylinder) rotation, but by extending the paper feed interval, the ink has more time to dry, which prevents ink marks on the back of the next sheet. The paper feed interval (skip rotation) can be set from 1 - 10.

- 1 Touch [Functions] on the Print Basic Screen.

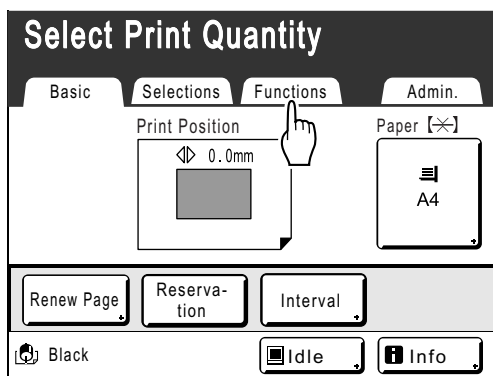

- 2 Touch [Interval].

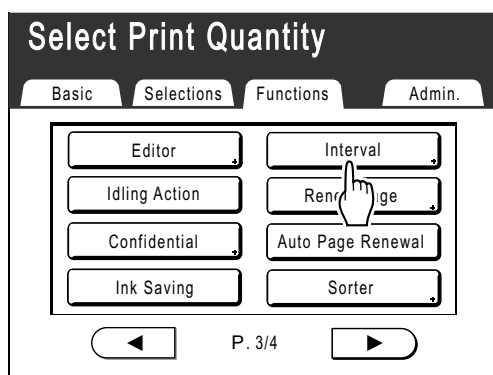

- 3 Touch [ON].

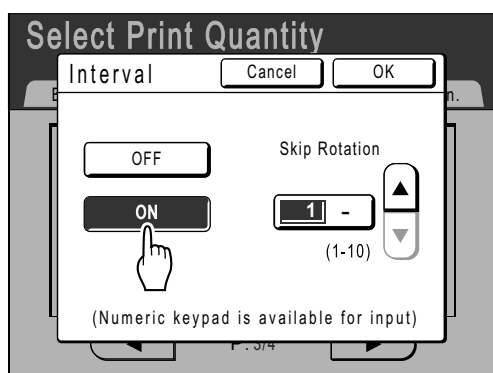

- 4 Touch  or  to set the number of Skip Rotations for the Print Drum (Cylinder).

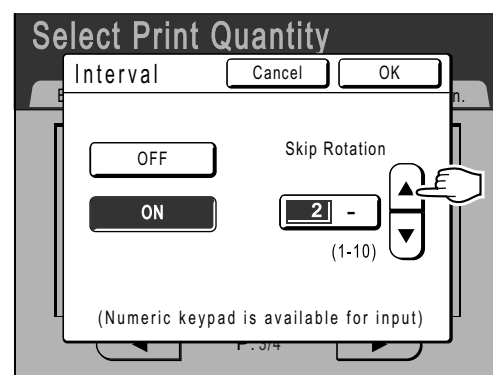

Note:

- Print Quantity Keys can also be used to enter numbers.
- If you are using extended paper and set the Print Drum (Cylinder) skip rotation to an odd number, the actual skip rotation is the "Set Number +1".
p.171

- 5 Touch [OK].

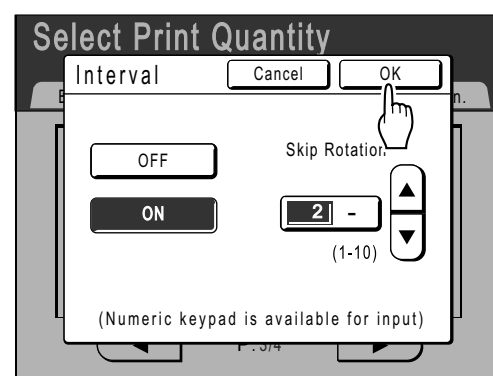

Returns to the Functions screen.
Interval setting is updated.

Paper Feed/Output Settings for Special Paper and Printing Types

[Jump Wing Control] [Special Paper Ctrl]

Paper feed and output settings can be adjusted when using special paper or uneven print finishes.

◆ Jump Wing Control

The following steps retrieve pre-configured custom settings for the Paper Jumping Wing. Use this feature to eject certain printing paper that is hard to eject with automatically adjusted normal Paper Jumping Wing setting.

Important!:

- “Jump Wing Control” feature is not available unless pre-configured.
- Only one setting can be pre-configured.
- To pre-configure or to change settings, please contact your dealer (or authorized service representative).

Note:

- The Paper Jumping Wing is a device which helps eject printed paper onto the Paper Receiving Tray. It automatically adjusts according to the position of the Paper Feed Pressure Adjustment Lever (Normal or Card).

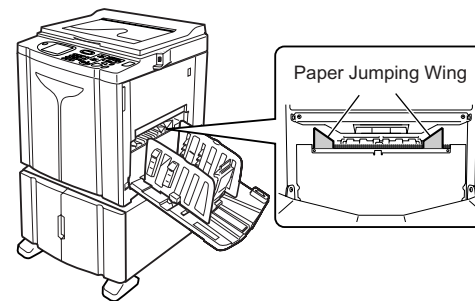

◆ Special Paper Ctrl

You can save settings for easy retrieval next time. The “Special Paper Ctrl” menu contains the following options:

Paper Feed Adj.

Adjust Paper Feed Tray position and paper-feed amount to suit special paper characteristics. For adjustment methods, please contact your dealer (or authorized service representative).

Paper Eject Adj.

Some types of original image/paper may be printed with an uneven or blurred finish due to separation fan settings. This option can be used to change separation fan and suction fan settings. For adjustment methods, please contact your dealer (or authorized service representative).

Setting the Jump Wing Control [Jump Wing Control]

- 1 Touch **[Functions]** on the **Print Basic Screen**.

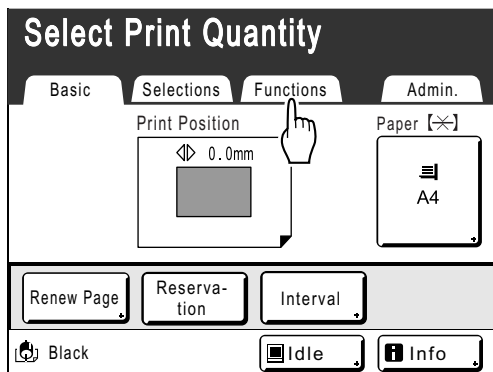

- 2 Touch **[Jump Wing Control]**.

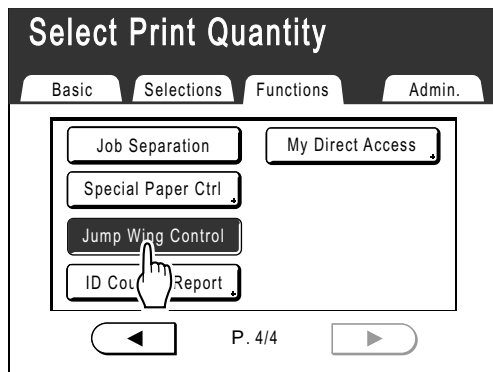

“Jump Wing Control” is selected.

Functions for Printing

Saving settings and Renaming the Parameter Names in the Parameter List

1 Touch [Functions] on the Print Basic Screen.

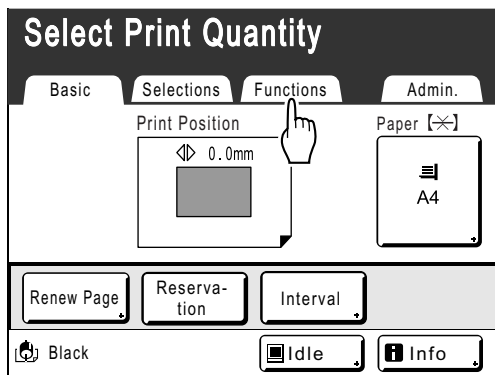

2 Touch [Special Paper Ctrl].

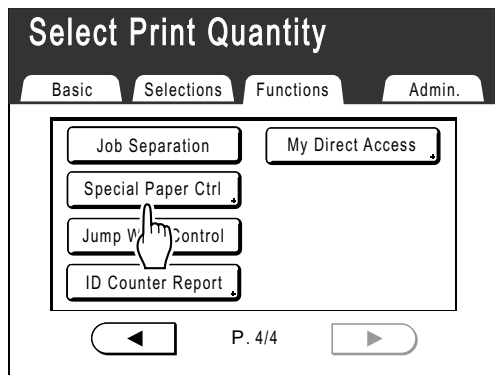

3 Adjust [Paper Feed Adj.] and [Paper Eject Adj.].

Note:

- For details of adjustments, see p.98.

4 Confirm the adjustments on the Special Paper Ctrl screen.

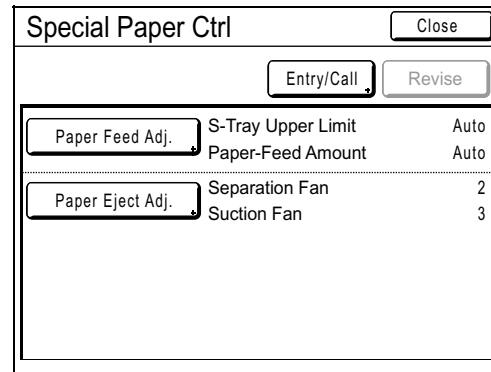

5 Touch [Entry/Call].

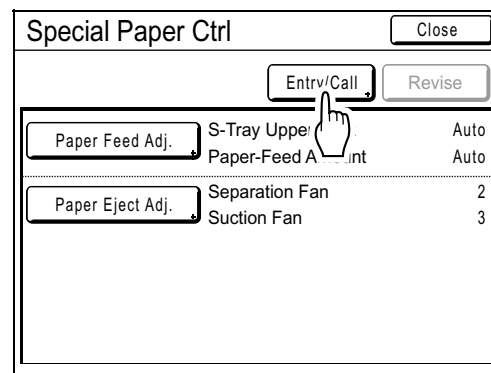

Parameter List screen is displayed.

6 Touch an unused button.

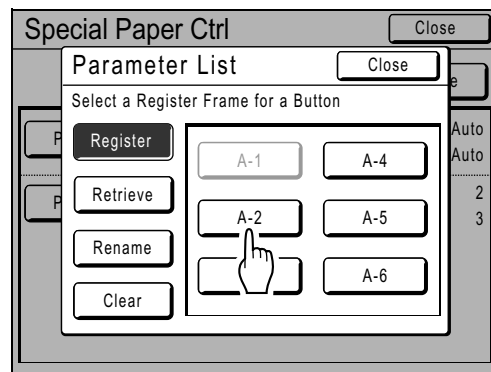

Unused buttons are displayed with a solid line. Used buttons are grayed-out and are not available.

7 Touch [OK].

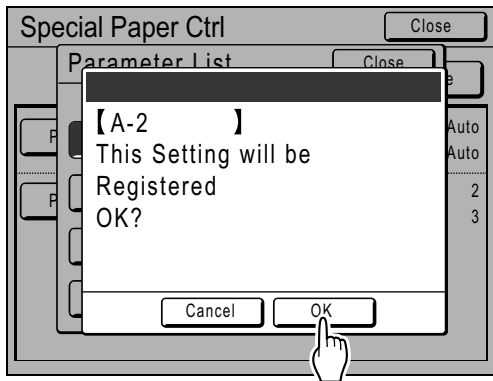

Returns to the Parameter List after the settings have been registered.
The name of each parameter can be changed for your convenience. To change parameter names, proceed to the next step.

Note:

- After registering the settings, touch **[Close]** on the Parameter List screen to return to the Special Paper Ctrl screen.
- Touch **[Close]** on the Special Paper Ctrl screen to return to the Functions screen. Printing will be done with the registered settings.
- If you do not wish to print after registering the settings, press the  key on the control panel.

8 Touch [Rename].

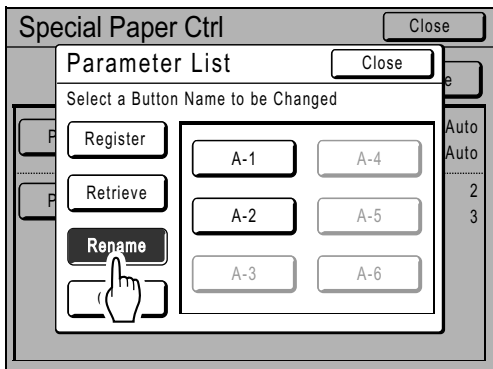

9 Touch the button to rename.

Unregistered buttons are grayed-out and are not available.

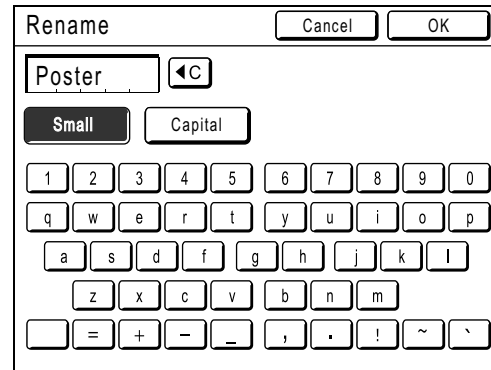

10 Touch the character buttons to enter a new name.



Change capitalization by selecting the **[Small]** or **[Capital]** button.

 p.130

Note:

- To delete the current name, touch  button or press the  key.

11 Touch [OK] after entering all the characters.

Returns to the Parameter List screen and the name is updated.

12 Touch [Close].

Returns to the Special Paper Ctrl screen.

Functions for Printing

Retrieving Settings from the Parameter List

1 Touch [Functions] on the Print Basic Screen.

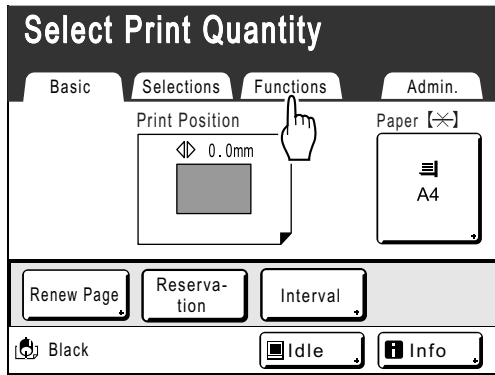

2 Touch [Special Paper Ctrl].

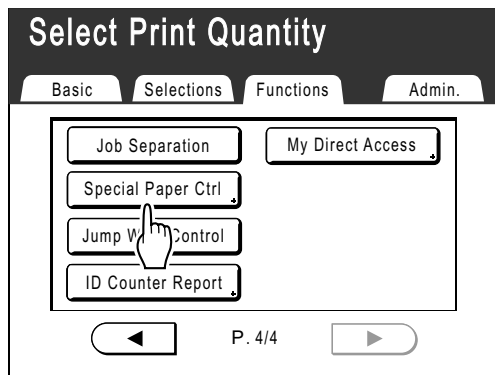

3 Touch [Entry/Call].

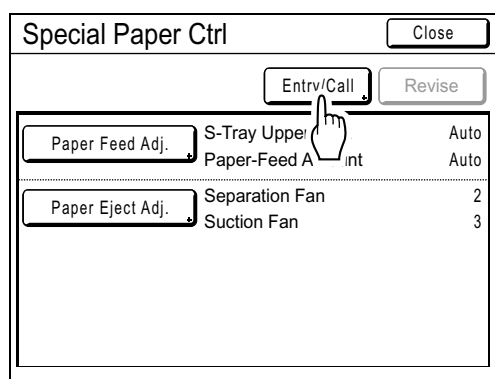

Display the Parameter List screen.

4 Touch [Retrieve].

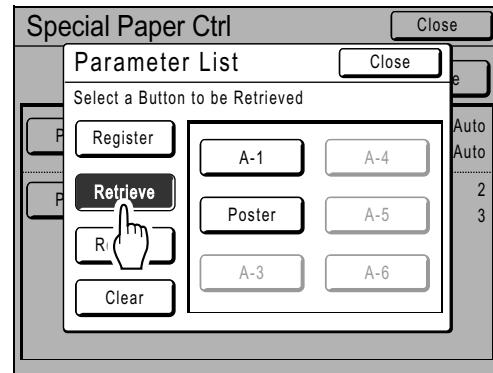

5 Touch the button to retrieve.

Unregistered buttons are grayed-out and are not available.

Returns to the Special Paper Ctrl screen and the desired setting is retrieved.

Confirm the settings made.

Note:

- Repeat steps 3 to 5 to retrieve other settings.

6 Touch [Close].

Returns to the Functions screen and the settings are updated.

After this, follow the same operations for normal printing.

Making changes to Special Paper Ctrl Setting

- 1 Display the Parameter List screen.**
Follow steps 1 to 3 (p.102).

- 2 Touch [Retrieve].**

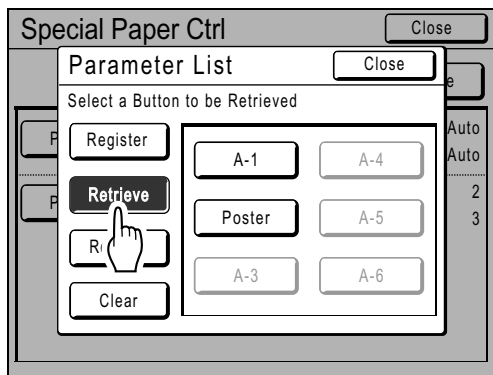

- 3 Touch the button to change.**

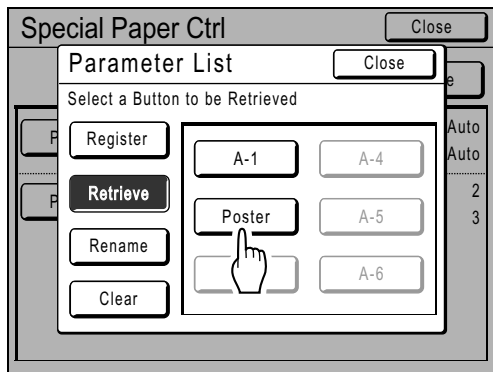

- 4 Change the setting parameters.**
Parameters for the following can be changed:
“Paper Feed Adj.” and “Paper Eject Adj.”.

Note:

- For details of changes, see p.98.

- 5 Touch [Revise] on the Special Paper Ctrl screen.**

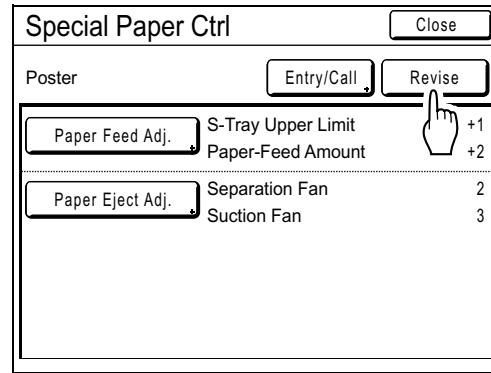

- 6 Touch [OK].**
Returns to the Special Paper Ctrl screen after parameters have been revised.

Functions for Printing

Clearing Special Paper Ctrl Settings

1 Display the Parameter List screen.

Follow steps 1 to 3 (p.102).

Important!:

- First, check whether the setting can be cleared. (Retrieve the appropriate setting and follow the steps beginning with step 2.)
- Cleared settings cannot be recovered.

2 Touch [Clear].

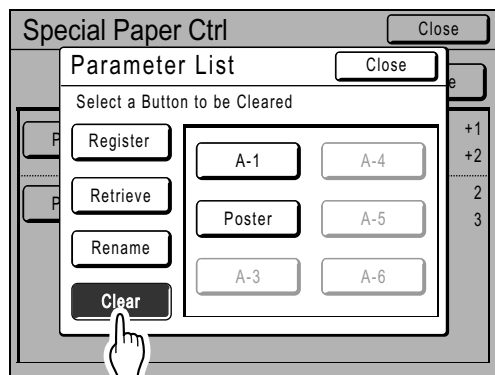

3 Touch the button to clear.

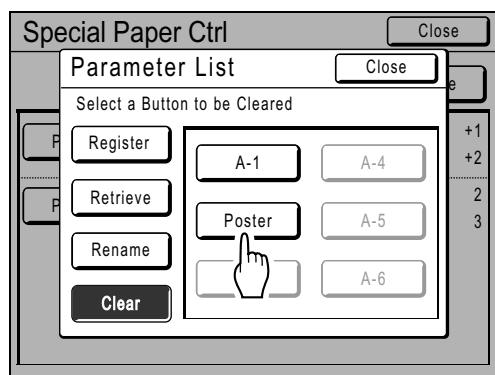

Unregistered buttons are grayed-out and are not available.

4 Touch [OK].

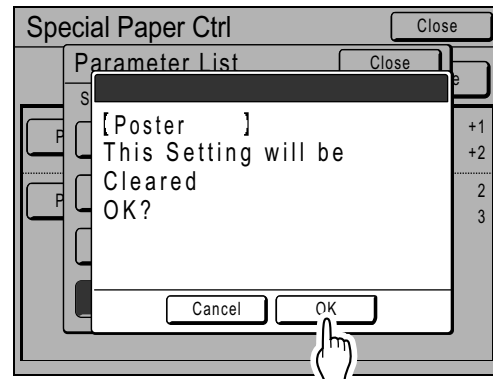

Returns to the Parameter List screen. The selected setting is cleared.

5 Touch [Close].

Returns to the Special Paper Ctrl screen.

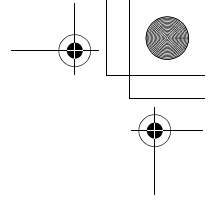

Functions for Printing

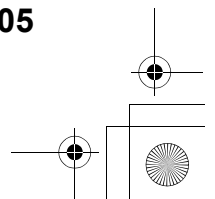
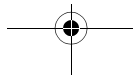
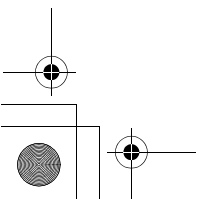
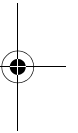
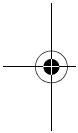

Advanced Features

Setting Up User Management [User Management]

This machine is equipped with a User Management function to ensure security and enhance user management. The User Management function has 3 Management Levels. The following features are available according to level.

Feature	Management Level		
	High/Full Management	Mid/ID Print Only	Low/Admin tab Only
[ID Counter Report] for managing the number of prints/masters. p.151	Available	Available For ID print only	Not Available
[Limit] for setting the upper limit of the number of copies/masters per user set. p.117	Available	Available	Not Available
[ID Print] for printing data sent from PC. p.44	Available	Available	Not Available
[My Direct Access] for registering the frequently-accessed functions displayed in the Direct Access Area. p.155	Available	Not Available	Not Available
Saving scanned originals for [ID Print] . p.178	Available	Not Available	Not Available
Allowing only the administrator to change the [Admin.] settings. p.165	Available	Available	Available

All users must be registered to manage the machine at the High/Full Management level. Also, users must input a PIN code (or connect a registered USB Flash Drive) to use the machine.

This section explains settings for using the User Management function and how to make those settings set by the Administrator.

Management Level and access timing of user identification access

When "Management Level" is set to "High/Full Management" or "Mid/ID Print Only", the users will be asked to identify themselves ("User identification access") during operations. The Recognition and Identification System can be selected from either "PIN code" or "USB Flash Drive" which set by the administrator in advance.

	When Operating the Machine	When Outputting the ID Print
High/Full Management	<p>User identification access is required</p>	<p>User identification access is not required</p>
Mid/ID Print Only	<p>User identification access is not required</p>	<p>User identification access is required</p>
Low/Admin tab only	<p>User identification access is not required</p>	<p>ID Print cannot be performed</p>

User Management Options

To activate the User Management function, the administrator must set up User Management. The setting options of User Management and details are explained below.

◆ **"Recognized by" (p.109)**

Select the Recognition and Identification System.

PIN code: When user identification access is required, input the PIN code.

Set up to 8 digits for each user in "Create User".

USB Flash Drive: When user identification access is required, connect the registered USB Flash Drive to the USB slot. Prepare the number of USB Flash Drives for the individual users and register them with the machine.

OFF/Delete: Delete the information registered in User Management (administrator/user registration included), and return to the factory setting.

Important!:

- If the "Recognized by" setting is changed, all settings in User Management, including the administrator's registration, will be deleted. Set "Recognized by" first, then operate the other settings.

◆ **"Management Level" (p.111)**

Select the Management Level from among 3 levels.

High/Full Management: Users require identifying themselves when operating the machine and outputting the ID Print.

Mid/ID Print Only: Users require identifying themselves when outputting the ID Print.

Low/Admin tab only: Manages the users without any use of security features. Users don't require identifying themselves when operating the machine and cannot perform ID print. This level allows only the administrator to change the [Admin.] settings.

For details, see the table of p.106.

Advanced Features

◆ Create User (☞ p.112)

Register the administrator/users.

Up to 100 users (administrator included) can be registered.

Set following options when registering.

- PIN code or USB Flash Drive

PIN code: A PIN code can be set for user identification access.

We recommend that you prepare a list of the registered users and record the user registration numbers (ID) and PIN codes for each user.

Notify each user of the set PIN code and user registration number (ID).

USB Flash Drive: A USB Flash Drive can be set for user identification access.

We recommend that you record which USB Flash Drives you distribute to which user.

Distribute to each user a registered USB Flash Drive and a user registration number (ID).

- **Rename**
- **Group:** User groups can be set.
- **Limit:** The upper limit of the copies/masters can be set.
- **Disable:** User identification access can be enabled or disabled.

Registered settings can be changed or cleared.

In order to register users or operate other settings in User Management, the administrator must be registered in advance. The User Management functions are activated after registering the administrator.

◆ Rename Group (☞ p.121)

Set a group name when operating group management.

Up to 32 groups can be registered.

◆ Reset Counter (☞ p.122)

Clear the usage counters of all users and groups.

Operation flow of User Management

We recommend that you set up User Management in following order.

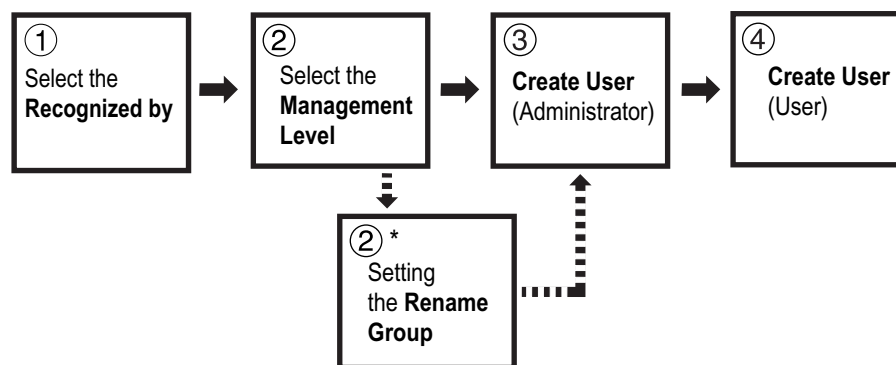

*Set when you want to count user usage by group using "ID Counter Report". See ☞ p.151.

Selecting Recognition and Identification System

Set the Recognition and Identification System using "Recognized by" in advance when setting up User Management.

Important!:

- If "Recognized by" is changed, all settings in User Management, including the administrator's registration, will be cleared.

1 Touch [Admin.] on the Basic Screen for each mode.

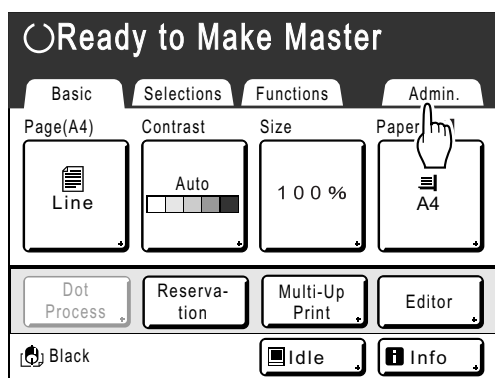

2 Touch [OK].

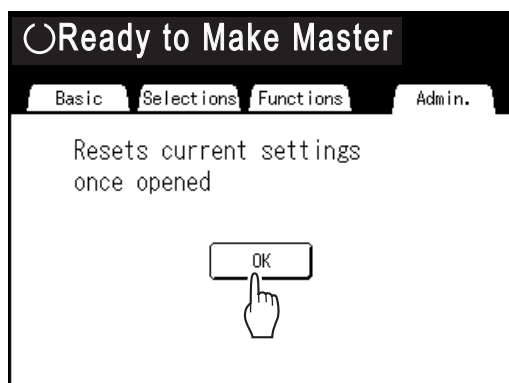

Skip to step 4 if the administrator is not registered. If the administrator is already registered, the Recognition Screen is displayed here. See step 3.

3 Identify the administrator.

◆ When "Recognized by" is set to "PIN code"

Input the administrator's PIN code.

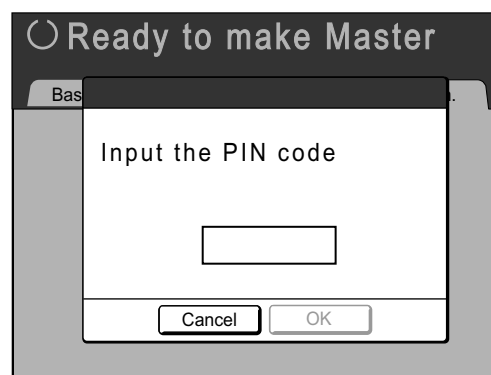

◆ When "Recognized by" is set to "USB Flash Drive"

Connect the administrator's registered USB Flash Drive to the USB slot.

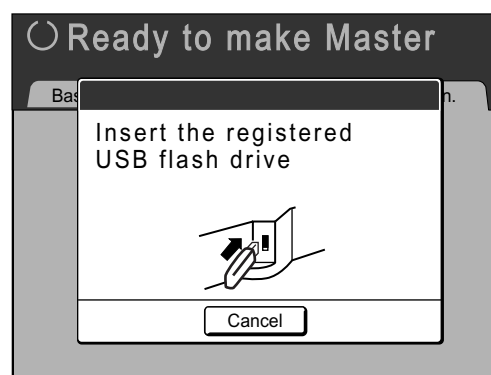

Advanced Features

4 Touch [User Management].

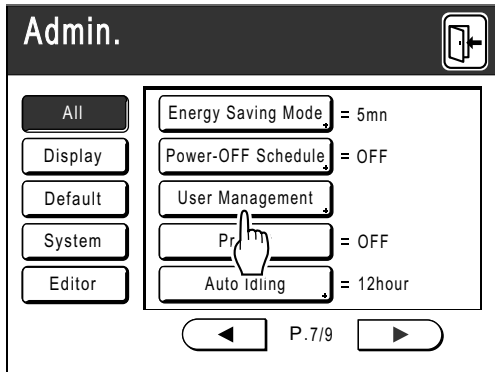

5 Touch [Recognized by].

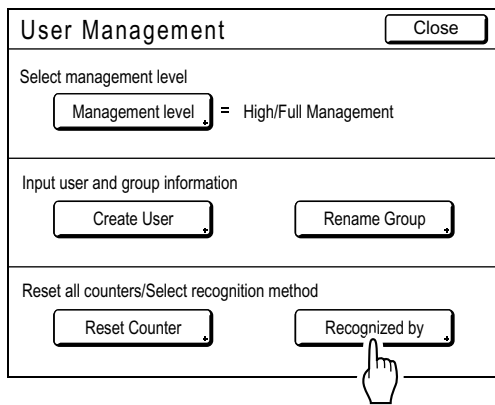

6 Touch the button to select the “Recognized by” option.

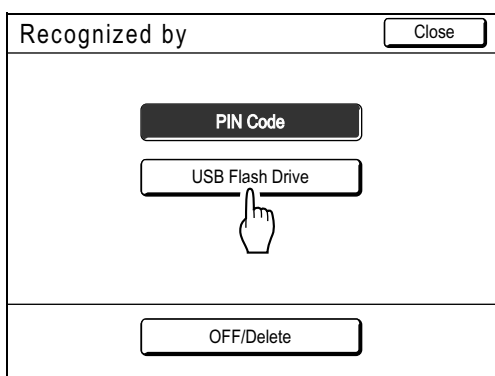

Note:

- If you touch **[OFF/Delete]**, all settings set in User Management will be deleted and returned to the factory setting.

7 Touch [OK].

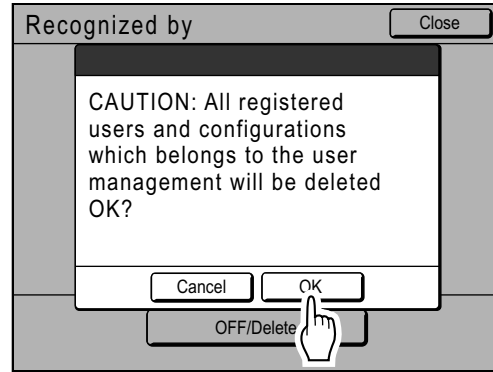

Returns to the User Management screen. “Recognized by” is updated.

Continue User Management settings. See the subsequent pages.

Setting Up the Management Level

Important!:

- Set “Recognized by” in advance.
☞ p.109

1 Display the User Management screen.

Follow steps 1 to 4 in “Selecting Recognition and Identification System” (☞ p.109).

2 Touch [Management Level].

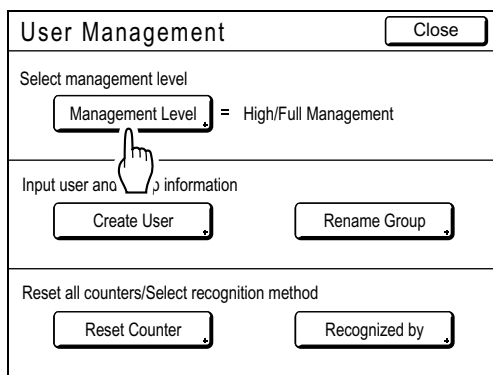

3 Touch the button to select the “Management Level” option.

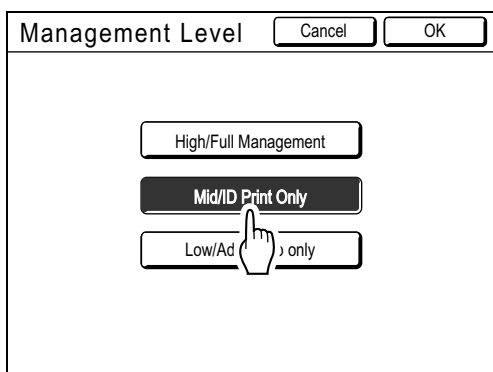

See ☞ p.106 for details of Management Level options.

4 Touch [OK].

Returns to the User Management screen. “Management Level” is updated. You can continue registering users and renaming groups if needed.

To close the User Management setting, touch **[Close]** on the User Management screen to return to the Admin. screen.

Advanced Features

Registering Administrator/Users

In order to activate the User Management function, the administrator must be registered. Up to 100 users can be registered (administrator included).

Note:

- The user registration number (ID) is required when operating “ID print” from the printer driver.

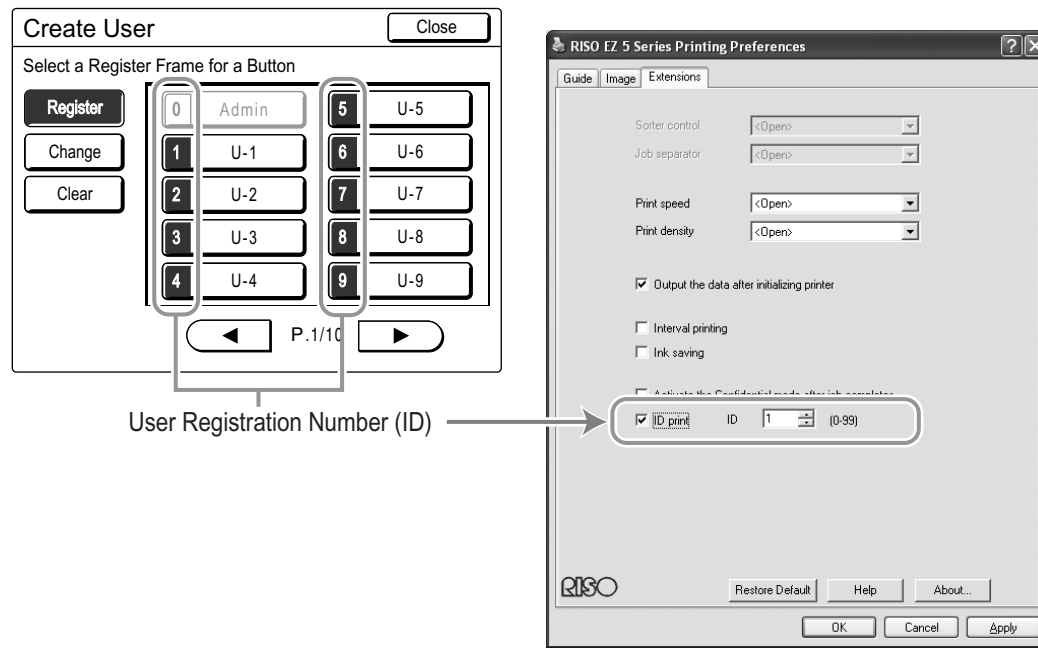

◆ Basic operation for registering administrator/users

1 Display the User Management screen.

Follow steps 1 to 4 in “Selecting Recognition and Identification System” (p.109)

Important!:

- Set “Recognized by” in advance.
- If you set the group to assign, we recommend that you set “Rename Group” first. (p.121)

2 Touch [Create User].

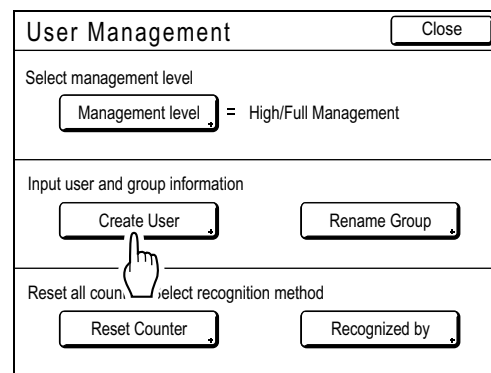

3 Touch an unused button.

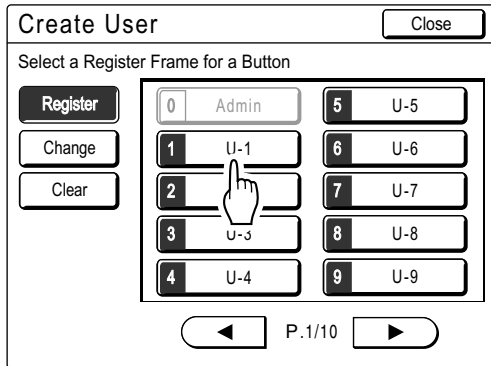

Unused buttons are displayed with a solid line. Used buttons are grayed-out and are not available. (Another user has been registered.)

Important!:

- Be sure to register the administrator first.
- If the administrator is not registered, buttons are not available except “0 Admin”.
- The “0” button is only available to the administrator. Even if you rename this button, it will be treated as the administrator.

4 Input the PIN code or connect the USB Flash Drive.

◆ When “Recognized by” is set to “PIN code”

Input the PIN code using the Print Quantity Keys.

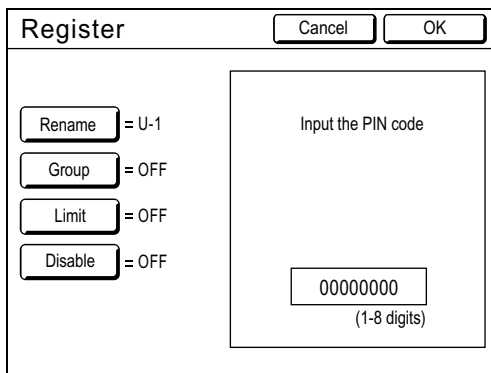

Up to 8 digits can be input. Press the **C** key to clear the PIN code.

◆ When “Recognized by” is set to “USB Flash Drive”

Connect the registered USB Flash Drive to the USB slot.

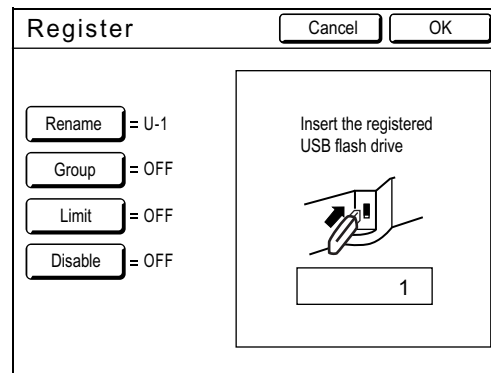

The number that identifies the registered USB Flash Drive is displayed.

Note:

- If you register multiple USB Flash Drives, we recommend that you ready them to be distinguished later (for example, put a user name on the USB Flash Drive).
- If you input the assigned PIN code (“Recognized by”: PIN code) or connect the USB Flash Drive that you already registered (“Recognized by”: USB Flash Drive), the following message is displayed when touching [OK].

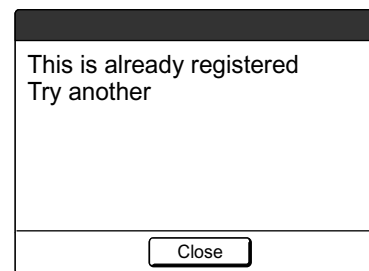

Touch **[Close]** and input the unassigned PIN code or connect the unregistered USB Flash Drive.

5 Set various settings.

Set the following settings if needed.

- Rename (p.115)
- Group (p.116)
- Limit (p.117)
- Disable (p.118)

Advanced Features

6 Touch [OK].

Returns to the Create User screen.
The administrator or the user is registered.
To register multiple users, touch **[Register]** and repeat steps 3 to 6.

7 Touch [Close].

Returns to the User Management screen.
You can continue registering users and renaming groups if needed.

To close the User Management setting, touch **[Close]** on the User Management screen to return to the Admin. screen.

◆ Enter the User Name

1 Touch [Rename] on the Register screen.

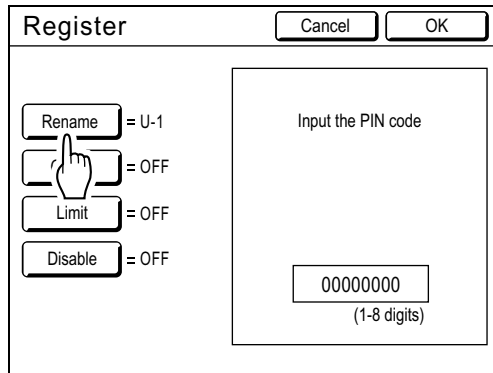

3 Touch [OK].
Returns to the Register screen.
The user name is renamed.

2 Touch the character buttons to enter a new name.

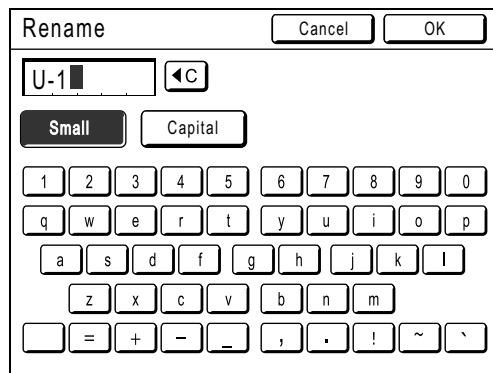

Change capitalization by selecting the **[Small]** or **[Capital]** button.
p.130

Note:

- To clear the current name, touch **[C]** button or press the **[C]** key.

Advanced Features

◆ Setting the Group to assign

When you set up a group by user, user usage can be counted by group.
It is recommended to enter the group name in advance.
☞ p.151

1 Touch [Group] on the Register screen.

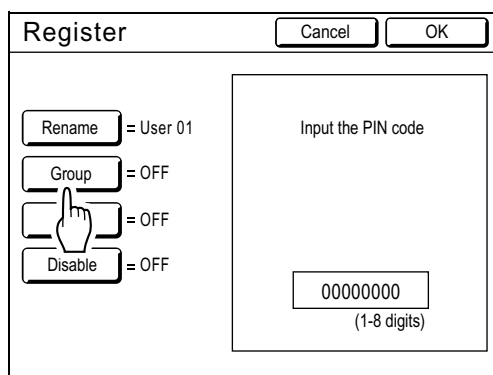

2 Touch the Group button to set.

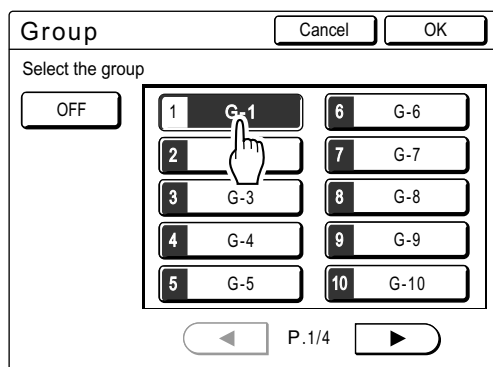

Note:

- If you are not setting up a group, touch **[OFF]**.
- The group button can be renamed. See ☞ p.121

3 Touch [OK].

Returns to the Register screen.
The user is assigned to the group that you set.

◆ Setting the Upper Limit of the User's Usage

Set the upper limit of the number of copies/masters.

Up to 99,999,999 can be set.

The present copy count and master count can also be cleared.

1 Touch [Limit] on the Register screen.

2 Touch the limit input box and enter the upper limit number using the Print Quantity Keys.

C/C: Copy Count
M/C: Master Count

Note:

- To clear the number, press the **C** key.
- "Present C/C" and "Present M/C" show the current amount of copies and masters that the user used.
- To clear the "Present C/C" and "Present M/C", touch each **C** button.

3 Touch [OK].

Returns to the Register screen.
"Limit" is updated.

Advanced Features

◆ Disabling User identification access

Touch **[Disable]** on the Register screen to turn it “ON”.

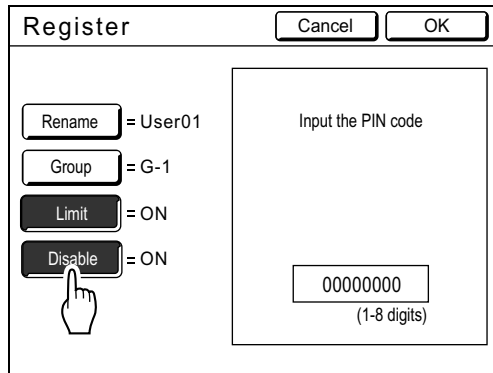

User identification access is disabled and the user cannot use the machine.

Note:

- To inactivate “Disable”, touch **[Disable]** to turn it “OFF”.
- On the Register screen for the administrator, a **[Disable]** button is not available.

Changing Administrator/User Registration

1 Display the User Management screen.

Follow steps 1 to 4 in “Selecting Recognition and Identification System” (p.109)

2 Touch [Create User].

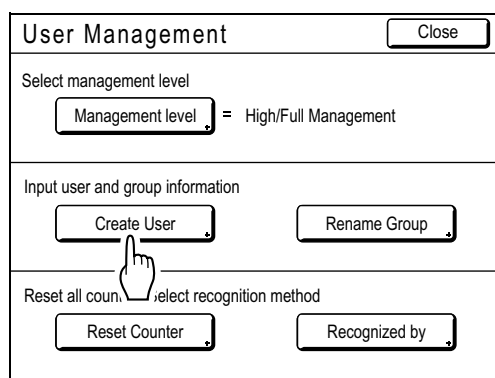

3 Touch [Change].

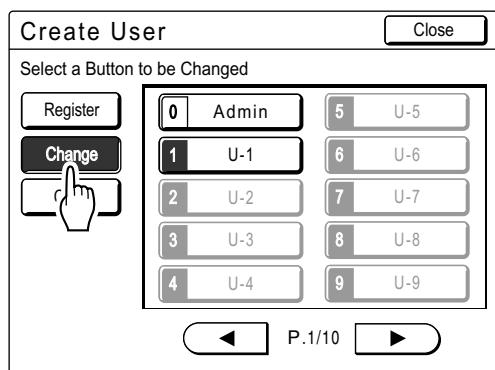

4 Touch the User Button to change.

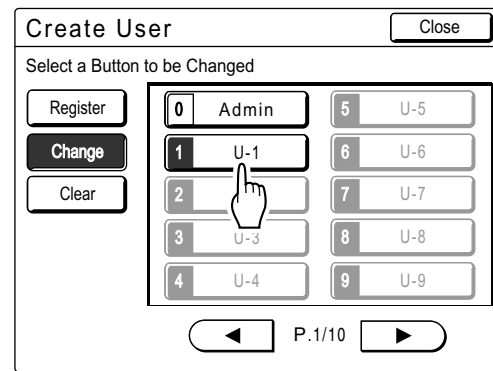

Registered buttons are displayed with a solid line. Unregistered buttons are grayed-out and are not available.

5 Change various settings.

Follow steps 4 to 5 in “Basic operation for registering administrator/users” (p.112).

6 Touch [OK].

Returns to the Create User screen.
Registered setting is updated.

7 Touch [Close].

Returns to the User Management screen.

To close the User Management setting, touch **[Close]** on the User Management screen to return to the Admin. screen.

Advanced Features

Clearing User Registration

1 Display the User Management screen.

Follow steps 1 to 4 in “Selecting Recognition and Identification System” (p.109)

2 Touch [Create User].

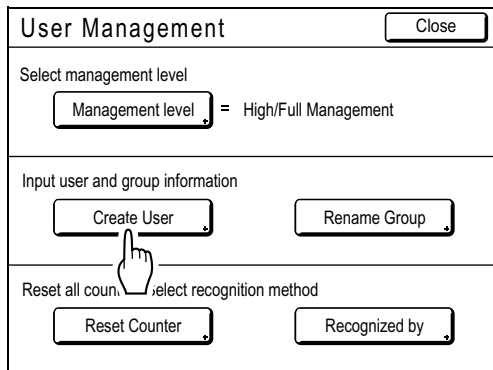

3 Touch [Clear].

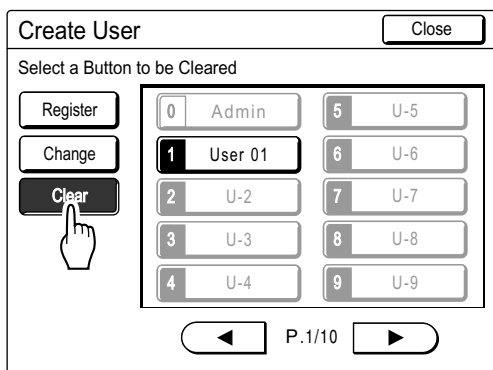

4 Touch the User Button to clear.

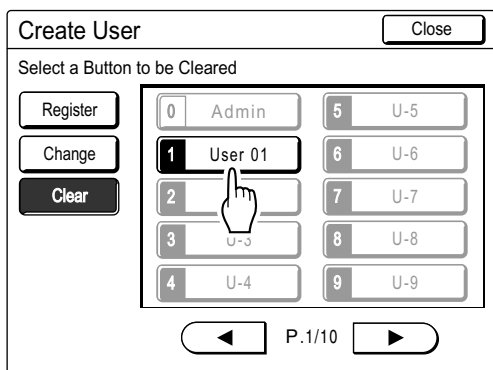

Registered buttons are displayed with a solid line. Unregistered buttons and “0 Admin” button are grayed-out and are not available.

Important!

- Once the user registration is cleared, it cannot be recovered.

5 Touch [OK].

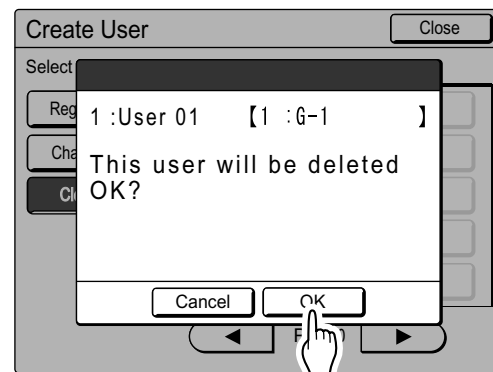

Returns to the Create User screen. The setting of the selected user is cleared.

6 Touch [Close].

Returns to the User Management screen.

To close the User Management setting, touch **[Close]** on the User Management screen to return to the Admin. screen.

Renaming Groups

1 Display the User Management screen.

Follow steps 1 to 4 in “Selecting Recognition and Identification System” (p.109)

2 Touch [Rename Group].

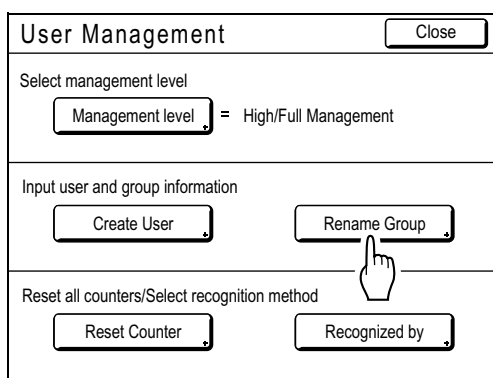

3 Touch the Group button to rename.

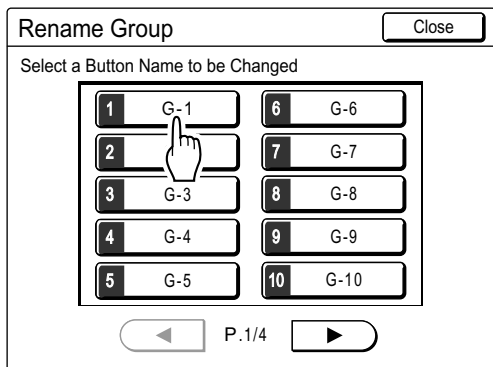

4 Touch the character buttons to enter a new name.

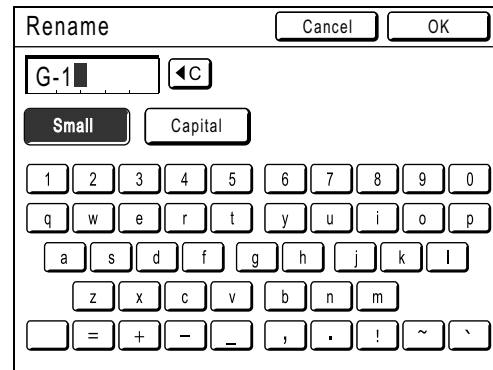

Change capitalization by selecting the **[Small]** or **[Capital]** button.
p.130

Note:

- You can enter up to 10 characters.

5 Touch [OK].

Returns to the Rename Group screen.
The group name is renamed.

6 Touch [Close].

Returns to the User Management screen.

To close the User Management setting, touch **[Close]** on the User Management screen to return to the Admin. screen.

Advanced Features

Reset All User Counters

All user counters can be cleared in a single procedure.

Important!:

- After the counter is cleared, it cannot be recovered.

1 Display the User Management screen.

Follow steps 1 to 4 in "Selecting Recognition and Identification System" (p.109)

2 Touch [Reset Counter].

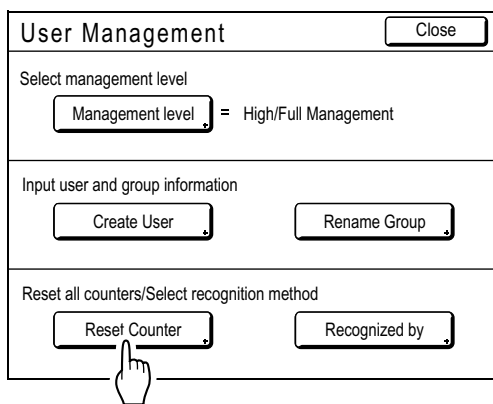

3 Touch [OK].

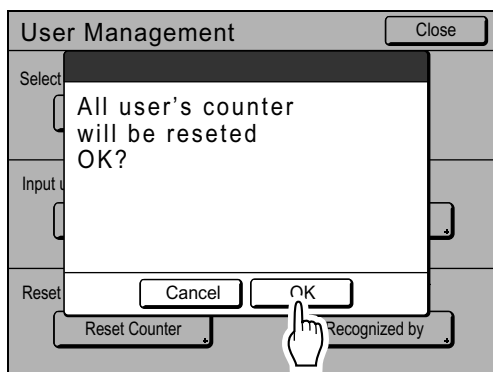

Returns to the User Management screen.
All user counters are cleared.

To close the User Management setting, touch **[Close]** on the User Management screen to return to the Admin. screen.

Automatic Sorting Into Groups [Program]

“Program” feature saves you from repeatedly having to enter how many copies to print, by assigning the number of copies per sets in advance. Operation stops after printing each set of copies.

Store a “Program” setting for easy retrieval later.

Sample usage for this feature; in a school setting, the number of copies (sheets) per class (set) can be pre-assigned, then the number of grades (groups) in the entire school.

“Program” consists of two types: “Single” and “Multiple”.

Important!:

- “Program” is not available when “Auto Page Renewal” is selected.

◆ Single Page Mode

From a single original document, print into multiple groups of sets.

A maximum of 50 groups can be created, each having up to 99 sets. Each set can be up to 9999 copies.

The machine can be configured to specify how many copies (sheets) per set, then how many sets are to be created for each group.

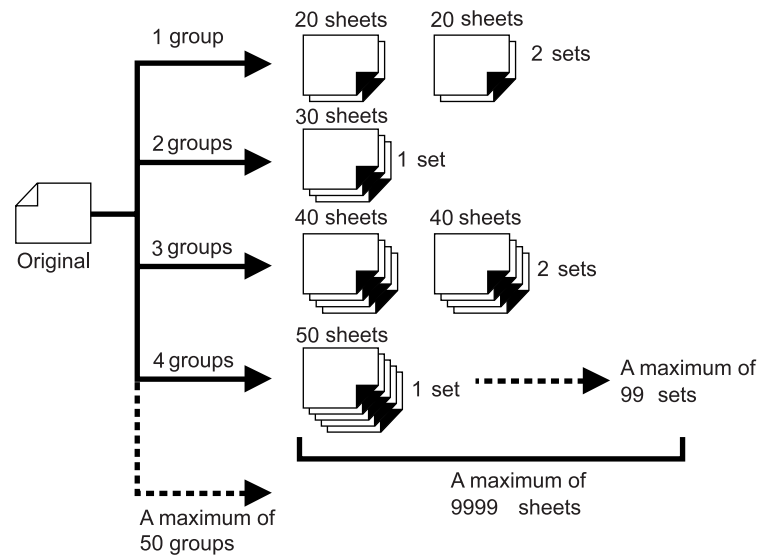

Note:

- If you are printing multiple originals with “Single Page” program, place multiple originals (up to 50) in the ADF unit (option), and as long as “Auto Process” is “ON”, the set program can be repeated and all the originals are divided into groups to print the various number of copies specified.

Advanced Features

◆ Multi-Page Mode

For multiple originals, a different number of copies are printed for each original.
From a single original, up to 9999 copies can be made.
Each original can reproduce a pre-assigned number of sheets (up to 20 originals).

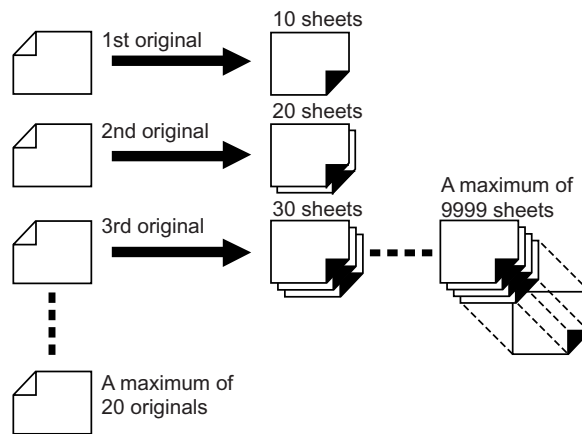

Note:

- This function cannot be used for printing from a computer data (direct print).
☞ p.45

How to Program Print

There are two ways to print in sets using "Program" printing feature.

- Program, then print (without saving the settings) [p.126](#)
- Retrieve a saved program, then print (when program is registered) [p.131](#)

Choose from the following actions on the Print Basic Screen.
Touch a button to proceed.

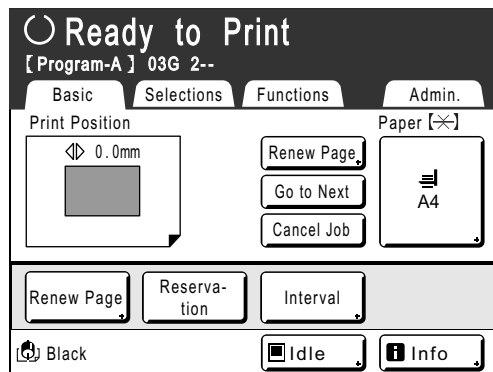

[Renew Page]: Creates a master from the last Master-Making data. [p.144](#)

[Next Page] or **[Go to Next]:** Stops current print job, skips to the next original, set or group.

[Cancel Job]: Cancels execution of the Program.

Note:

- The Job Separator (option) is useful for Programed Printing. The Job Separator releases a piece of tape after each set or original document, thereby automatically separating sets or groups. It eliminates the need to manually remove a stack of sheets or insert a marker between sets. Remember to activate "Job Separation" in the Functions screen when printing with the Job Separator. You must remove each stack from the Paper Receiving Tray, or insert a marker during the pause if not using the Job Separator.

Advanced Features

Setting Up for Programed Printing

There are two ways to display the Program screen.

- Touch **[Program]** on the Functions screen on the display.
- Press the **(OP)** key of the Print Quantity Keys.

In the following steps, the explanation will be for pressing the **(OP)** key of the print quantity keys.

1 Press the **(OP)** key.

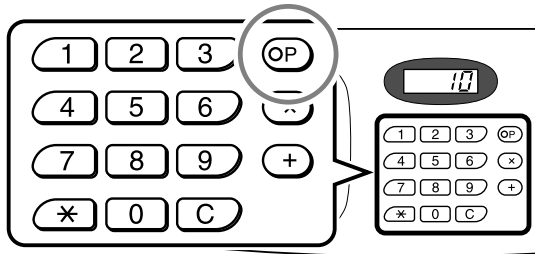

Note:

- Press the **(x)** key and skip to step 3 of the "Single Page Mode". Press the **(+)** key and skip to step 3 of the "Multi-Page Mode".

2 Touch **[Single]** or **[Multiple]**.

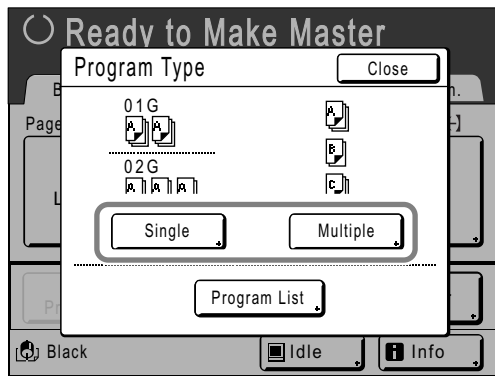

3 Enter the numbers using the Print Quantity Keys.

◆ For Single Page Mode

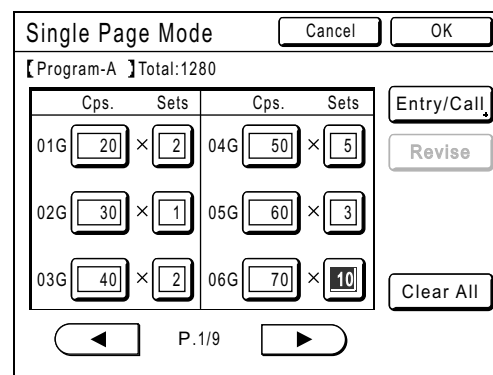

- 1) Enter the number of copies using the Print Quantity Keys.
- 2) Press the **(x)** key or the **(*)** key.
- 3) Enter the number of sets (in the group) using the Print Quantity Keys.
- 4) Press the **(+)** key or the **(*)** key.

To program more than one group, repeat steps 1) to 4).

Note:

- To cancel or change a number, press the **(C)** key and enter again.
- To clear all (number of copies and number of sets), touch **[Clear All]**.
- The total number of all copies to be printed is shown on the top of the screen.

Important!:

- To save the current Programed Printing setting, touch **[Entry/Call]**. Once **[OK]** is touched, the setting cannot be saved. See "Saving Programs" (p.128) for further information.

◆ For Multi-Page Mode

- 1) Enter the number of copies using the Print Quantity Keys.
- 2) Press the (+) key or the (**) key.
- 3) Repeat steps 1 and 2 above to enter the number of copies for each original.

Note:

- (+) and (***) keys can also move the entry box from top of to bottom.
- To cancel or change a number, press the (C) key and enter again.
- To clear all (number of copies and number of sets), touch **[Clear All]**.
- The total number of all copies to be printed is shown on the top of the screen.

Important!:

- To save the current Programed Printing setting, touch **[Entry/Call]**.
Once **[OK]** is touched, the setting cannot be saved.
See "Saving Programs" (p.128) for further information.

4 Touch [OK].

Returns to the original screen. Ready to print in accordance with the program.

Note:

- Alternatively, after entering number of copies or sets, press the (START) key to start printing without touching **[OK]**.

Advanced Features

Saving Programs

Store frequently-used Program settings for later retrieval and printing. A total of 12 settings (Single or Multiple Mode) can be stored.

1 Create and enter a Programed Printing settings.

Follow steps 1 to 3 in "Setting Up for Programed Printing" (p.126).

2 Touch [Entry/Call] on the Program screen.

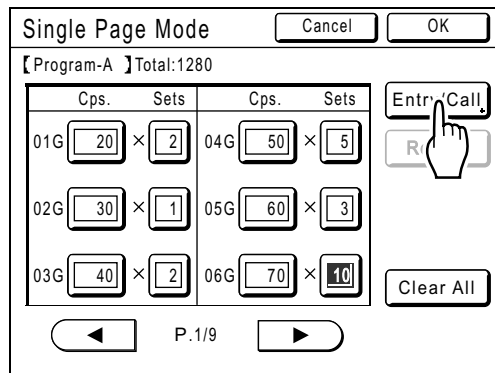

3 Touch an unused button.

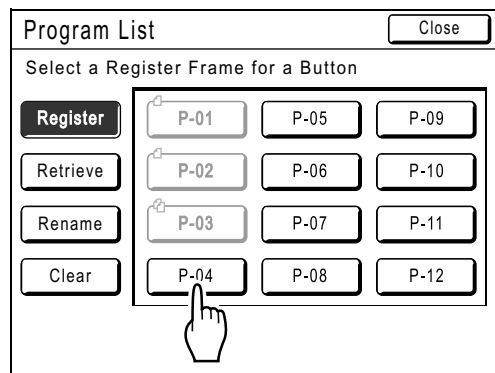

Unused buttons are displayed with a solid line. Used buttons are grayed-out and are not available.

4 Touch [OK].



Returns to the Program List screen. The Program is stored.

Each Program can be named for your convenience. See step 3 in "Renaming a Program" (p.129).

Note:

- After saving the Program, touch [Close] on the Program List screen to return to the Program screen. Touch [OK] on the Program screen to print from a saved Program.

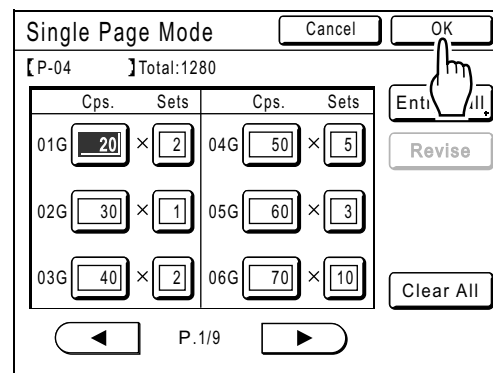

Renaming a Program

Program names can be changed to better describe their usage or purpose.

1 Touch [Program] on the Functions screen.

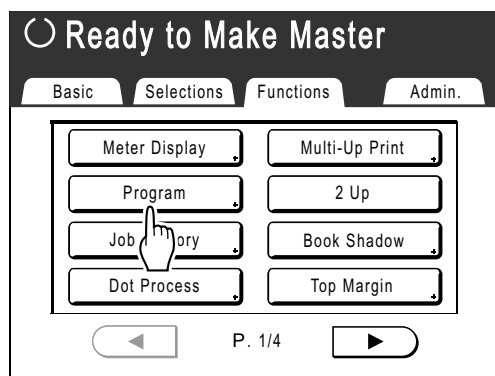

Note:

- If [Program] button is already highlighted, touching it will again display the Program screen, and not the Rename a Program screen. Touch [Cancel Job] then [OK] to return to Functions screen. Touch [Program] again.

2 Touch [Program List].

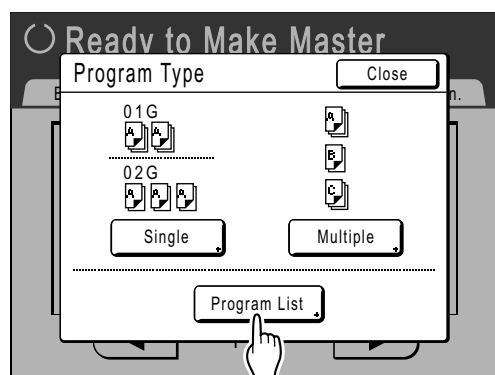

3 Touch [Rename].

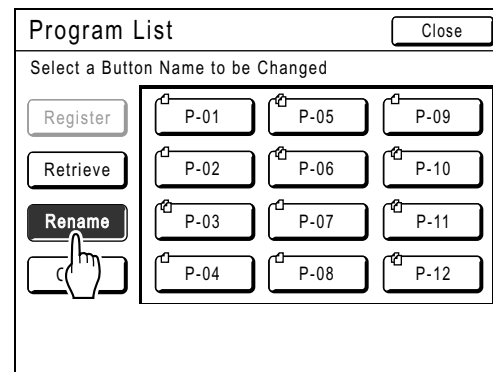

Note:

- Each Program button has an icon on top left. indicates Single Page Mode Program, indicates Multi-Page Mode Program.

4 Select a program to rename.

5 Touch the character buttons to enter a new name.

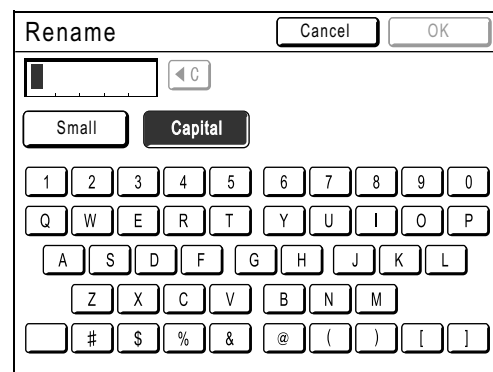

Change capitalization by selecting the [Small] or [Capital] button. [p.130](#)

Note:

- To delete the current name, touch button or press the key.

6 When entered, touch [OK].

Returns to the Program List screen. The program is renamed.

Advanced Features

Tip: Rename screen

◆ Small

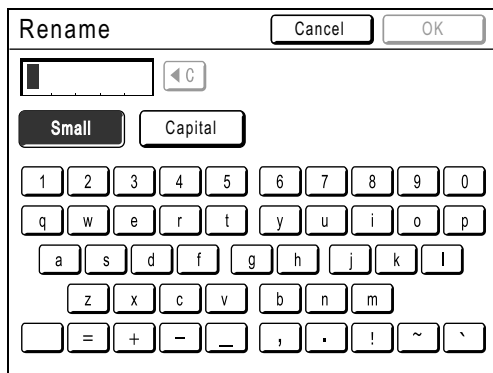

◆ Capital

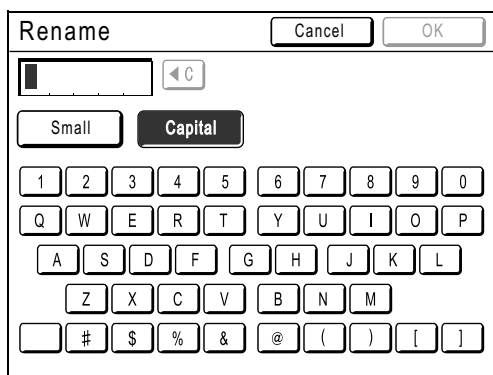

Note:

- You can enter up to 10 characters.
- Print Quantity Keys may also be used for entering numbers.
- button or key clears previously saved or current entry. Touch to clear one character at a time.

Retrieving a Program

Retrieve a stored program and modify its settings.

1 Press the  key.

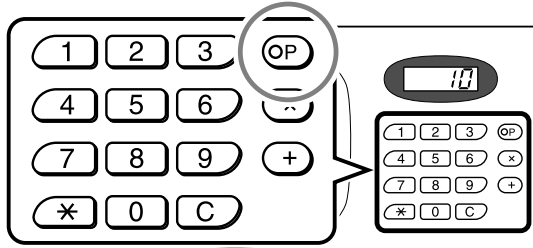

2 Touch [Program List].

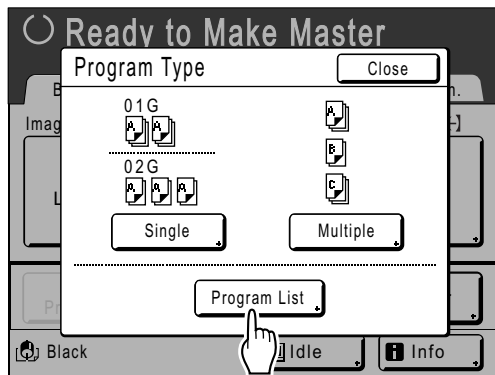

3 Touch a button to select a Program to retrieve.

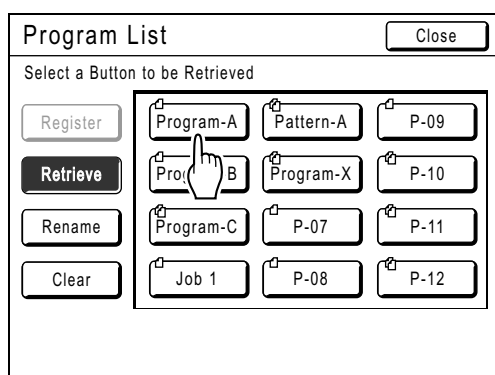

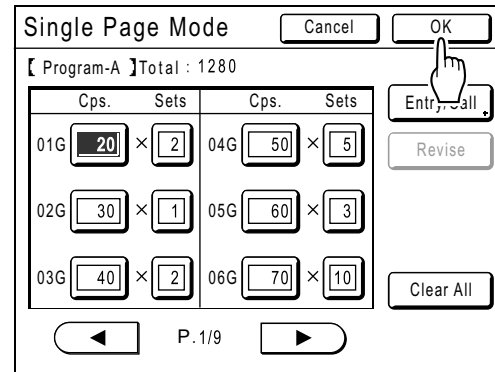

4 Touch [OK].



Returns to the original screen. Ready to print using the retrieved program.

Note:

- To cancel the program printing, press the  key (or touch **[Functions]**→**[Program]**) and then touch **[Cancel Job]** on the next screen displayed. Canceling program printing by pressing the  key will reset other settings.

Advanced Features

Clearing Programs

1 Display the Program List screen.
 Follow steps 1 to 2 in “Retrieving a Program” (p.131).

2 Touch [Clear].

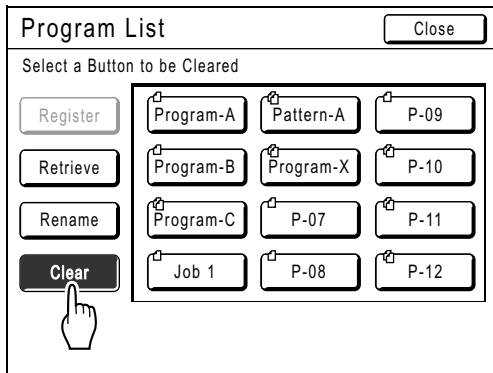

3 Select a program to clear.

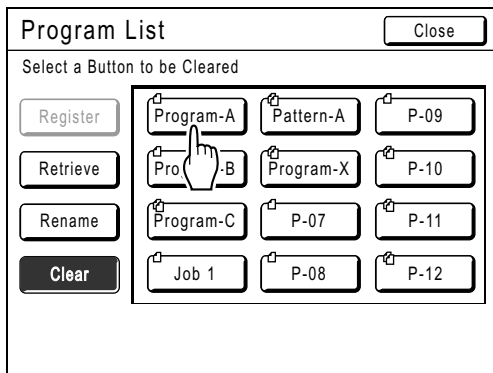

4 Touch [OK].

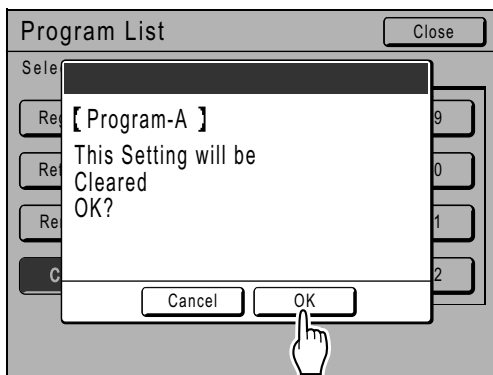

Returns to the Program List screen. The program is cleared.

Making changes to Stored Programs

- 1 Retrieve a program to modify.**
Follow steps 1 and 3 in “Retrieving a Program” (p.131).
- 2 Make changes to the Program.**
Modify number of copies or sets in the current screen.
Note:
 - See “Setting Up for Programed Printing” (p.126) for details on how to set up a program.
- 3 Touch [Revise].**

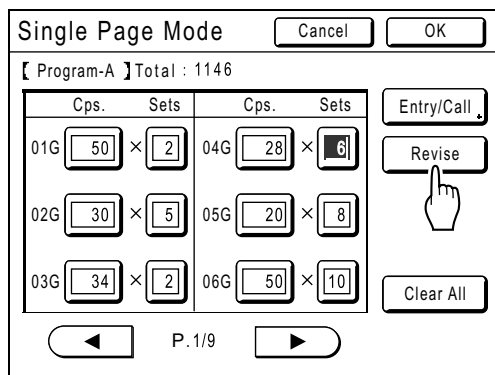

- 4 Touch [OK].**

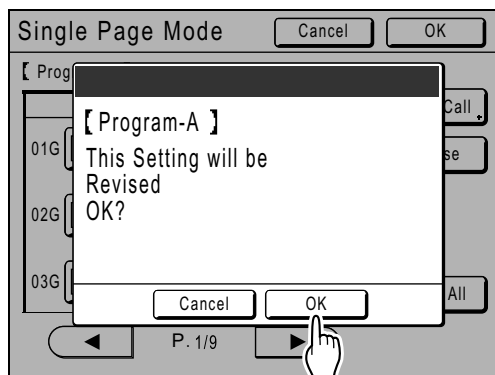

Returns to the Program screen. “Program” settings are updated (overwritten).

Advanced Features

Using Job Memory Functions [Job Memory]

Save the settings of the last print job into "Job Memory". Simply retrieve those "Job Memory" settings when doing a similar print job. Up to 10 jobs can be saved.

The following attributes can be saved to "Job Memory".

◆ MasterMaking/Print

Image	Max. Scan	Print Quantity	Interval
Dot Process	Book Shadow	Print Speed	ADF Semi-Auto*1
Contrast	Multi-Up Print	Print Density	Job Separation*1
Ink Saving	Top Margin	Print Position	Auto Page Renewal
Size	Contrast Adj	Paper Feed Adj.	Separation Fan
Margin+	Tone Curve	Jump Wing Control	Suction Fan
Paper Size	Side Margin	Auto Process	

*1 Available with optional device

◆ Link Mode (available with Linked Printer)

Image	Feed Tray	Print Quantity	Punch*
Dot Process	Book Shadow	Duplex*	Mailbox*
Contrast	Top Margin	Printer Collate*	Output Reversal*
Size	Contrast Adj	Offset Pages*	
Margin+	Tone Curve	Staple*	

*: Available with optional device

Storing Job Memory

- 1 Set various settings for a print job.
- 2 Touch [Functions] on the Master Making Basic Screen.

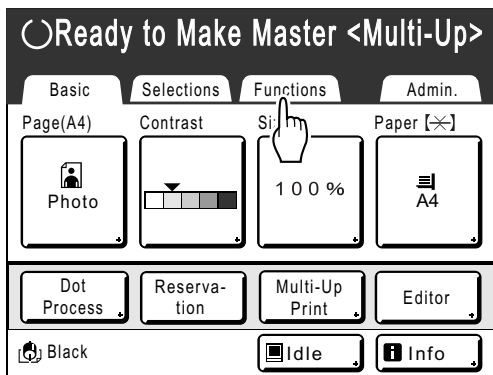

- 3 Touch [Job Memory].

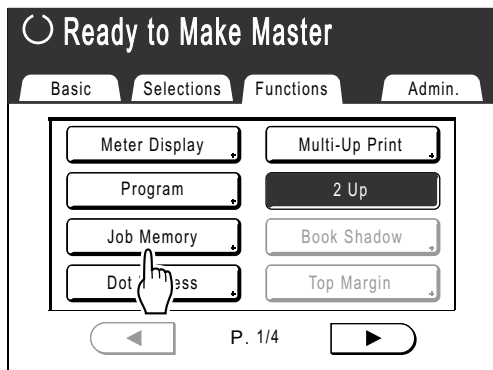

- 4 Touch an unused button.

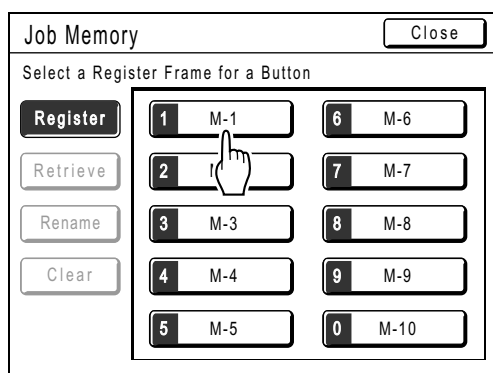

Unused buttons are displayed with a solid line. Used buttons are grayed-out and are not available.

Note:

- If you pressed the key to open the screen, first touch [Register] then select an available button.

- 5 Confirm settings.

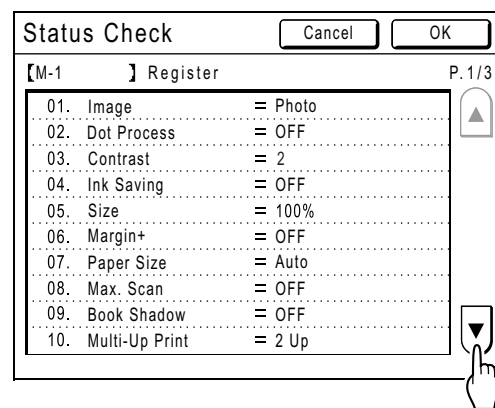

Touch and scroll down to check all items.

Note:

- To change a setting, touch [Cancel] and start over again. (Return to step 1.)

- 6 Touch [OK].

Returns to the Job Memory screen. Settings are updated.

Each job memory can be named for your convenience. See step 3 in "Renaming a Job Memory" (p.136).

Advanced Features

Renaming a Job Memory

1 Touch [Functions] on the Master Making Basic Screen.

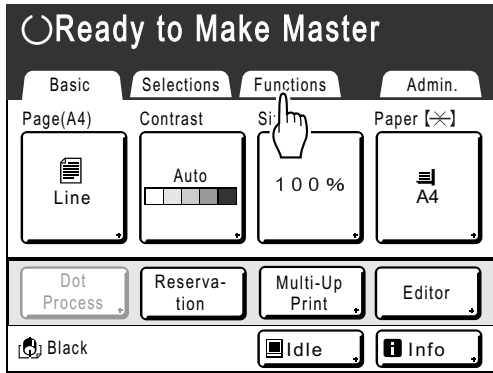

2 Touch [Job Memory].

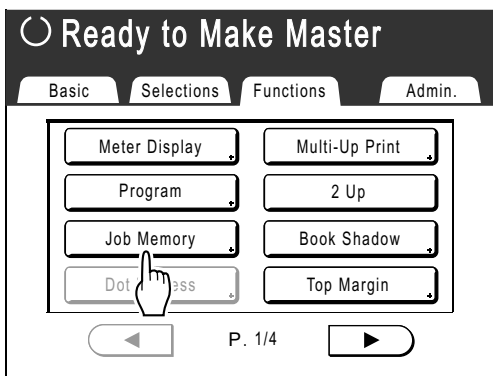

3 Touch [Rename].

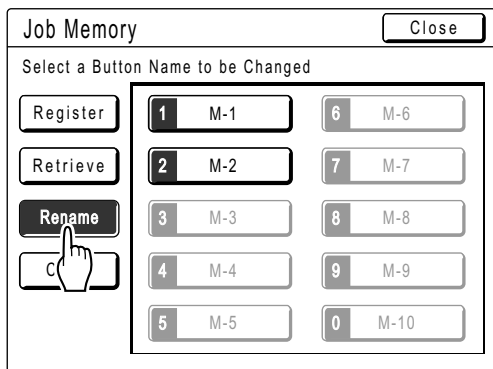

4 Select a Job Memory to rename.

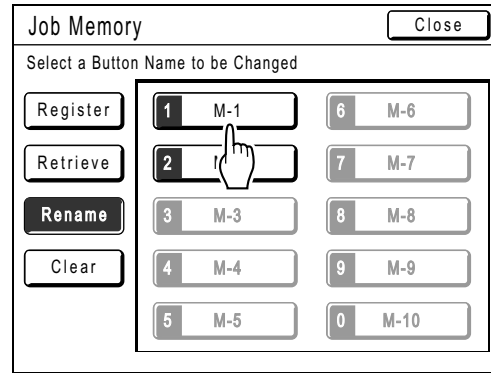

Unregistered buttons are grayed-out and are not available.

5 Touch the character buttons to enter a new name.

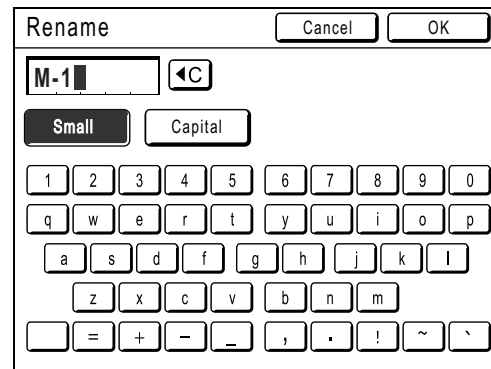

Change capitalization by selecting the **[Small]** or **[Capital]** button.

☞ p.130

Note:

- To clear the current name, touch **⏪** button or press the **C** key.

6 When entered, touch [OK].

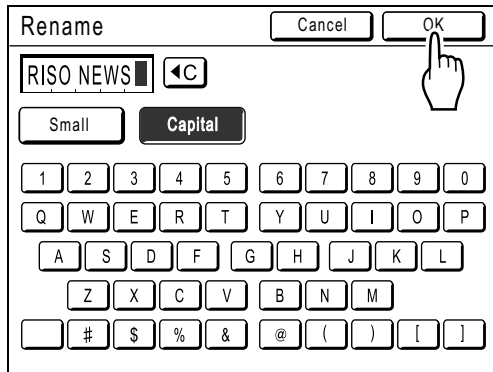

Returns to the Job Memory screen. The name is updated.

7 Touch [Close].

Returns to the Functions screen.

Advanced Features

Retrieving a Job Memory and Printing

There are two ways to display the Job Memory screen.

- Touch **[Job Memory]** on the Functions screen on the display.
- Press the  key of the Print Quantity Keys.

In the following steps, the explanation will be made for touching the display.

1 Touch [Functions] on the Master Making Basic Screen.

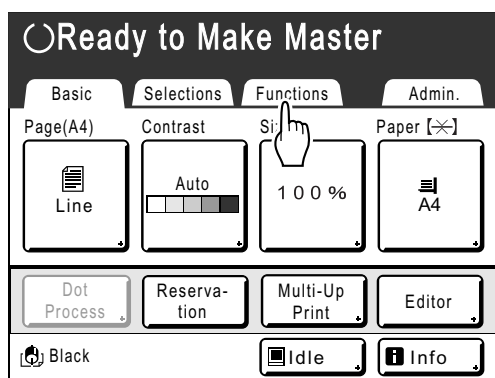

2 Touch [Job Memory].

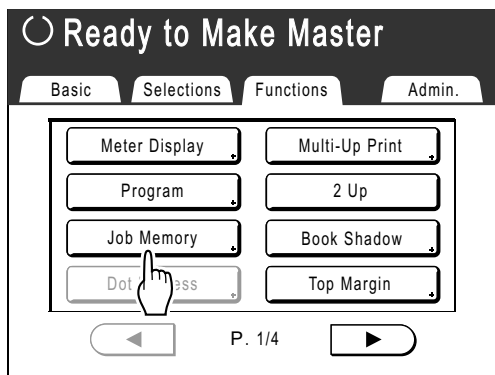

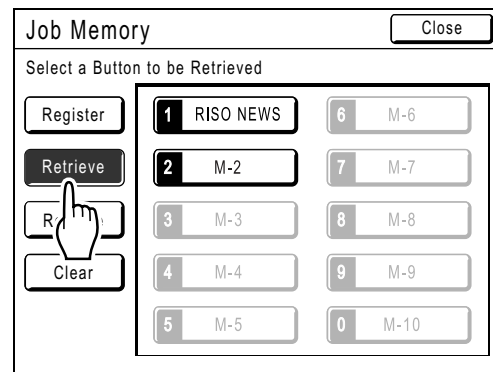

3 Touch [Retrieve].

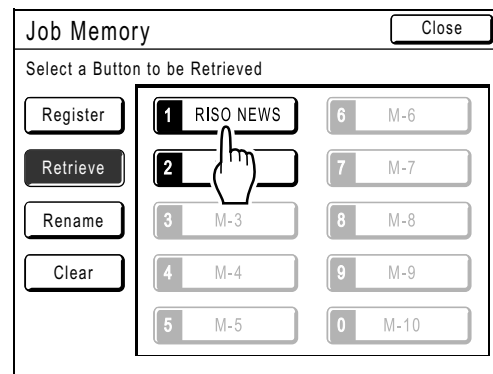

4 Select a Job Memory to retrieve.



Note:

- A job setting can also be retrieved using the Print Quantity Keys.
M-1 to 9:  to 
M-10: 

5 Confirm the settings and touch [OK].

Returns to the Functions screen. Ready to print using the retrieved job settings. Continue with the normal printing processes.

Note:

- To cancel a retrieved job memory, press the  key.

Tip:**Quick Retrieval**

A job setting can be retrieved via hardware keys without touching the Touch Screen.

For example, to retrieve and print job M-2, press the *****, **2**, **START** key in that order. M-2 is retrieved and starts the master-making process.

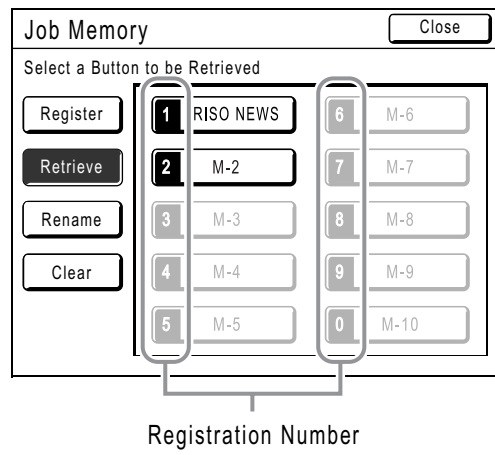

Advanced Features

Clearing Job Memory

1 Touch [Functions] on the Master Making Basic Screen.

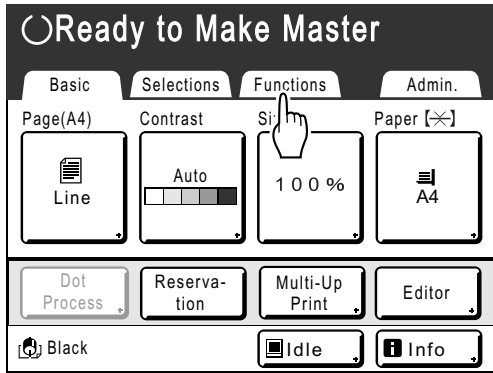

2 Touch [Job Memory].

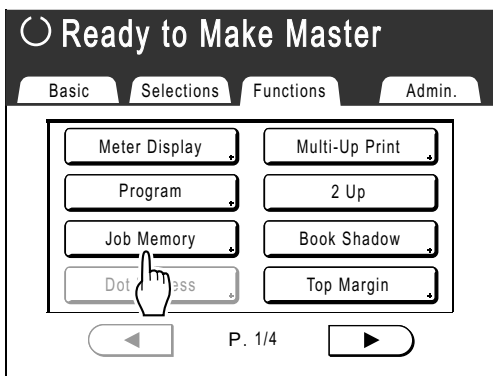

3 Touch [Clear].

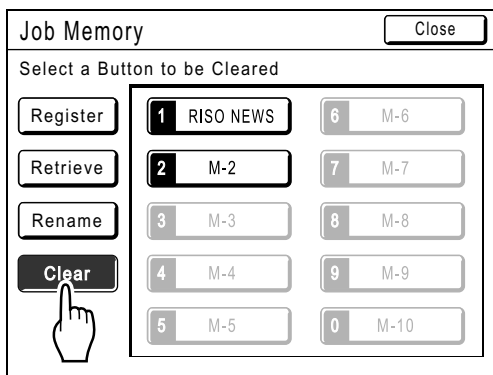

4 Select a Job Memory to clear.

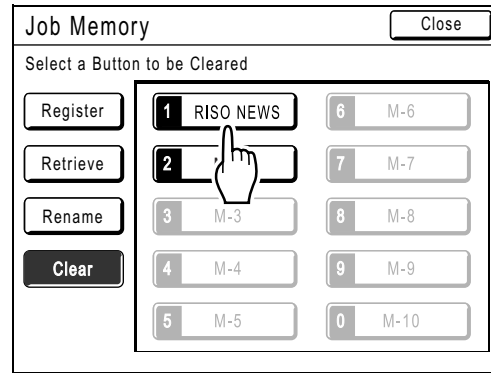

Important!:

- Make sure it is the job setting you want to delete.
- Once the Job Memory is cleared, it cannot be recovered.

5 Touch [OK].

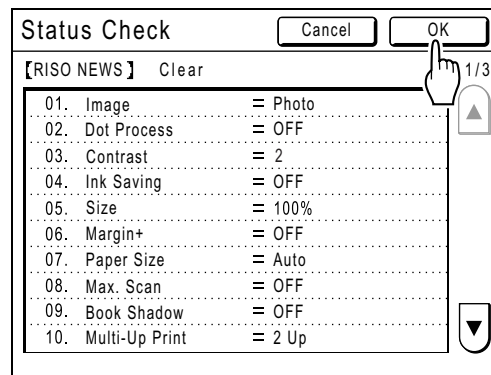

6 Touch [Close].

Returns to the Functions screen.

Protecting Confidential Documents

[Confidential]

After printing is complete, the master remains on the Print Drum (Cylinder) and is ready for printing another set of copies. To protect confidential documents from unauthorized duplication, use the Confidential feature to discard the master after printing.

Note:

- When “Confidential” is performed, the discarded master may no longer be reproduced, and “Renew Page” feature is disabled.
- If “Idling Action” is set to “ON”, “Idling Action” is executed using a confidential master (use this function when not using the Print Drum (Cylinder) for extended periods of time).
- You can set the machine to remind users to use the “Confidential” feature every time it is used.
p.173

1 Make sure printing is completed.

Confirm that everything is printed.

2 Touch [Functions] on the Print Basic Screen.

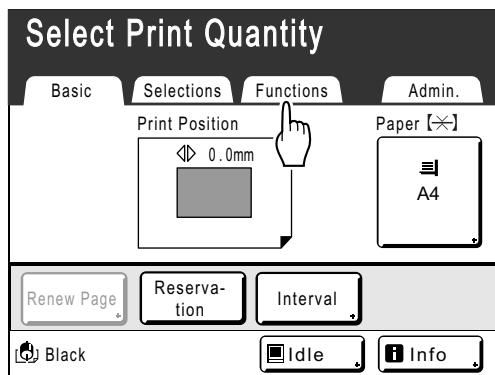

3 Touch [Confidential].

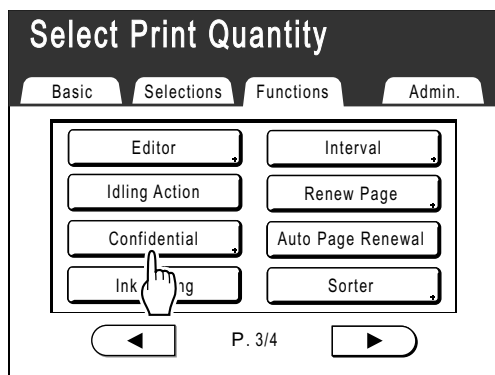

4 Touch [OK].

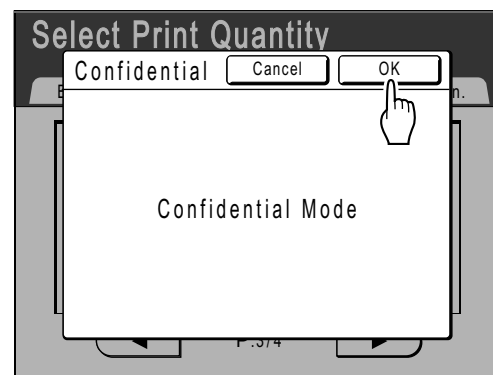

The current master is discarded, and a new master is set on the Print Drum (Cylinder).

Advanced Features

Extending the Reserve Period [Reservation]

This function is useful when the machine is connected to a computer. When the machine is inactive for a certain period of time, it determines that the current job is completed, even if the actual printing is still under way. If another person accidentally initiates another job from the computer, this will cause a new master to be made, discarding the current one.

By extending "Reserve Period", such interruption can be prevented. We recommend that you activate the "Reservation" setting when temporarily pausing a job or when printing leaflets, etc. to prevent interruption.

Note:

- Select from 5, 10, or 30 minutes as the "Reserve Period" on the Admin. screen. The factory default is 5 minutes.
☞ p.161
 - The following operations do not count towards reservation period.
 - When the machine is operating (making a master, printing, confidential action, idling, etc.)
 - When the Job Separator (option) is operating
 - When Control Panel buttons are being entered
 - When the setup screen for some function is displayed
 - Auto Sleep and Auto Power-OFF will be disabled during the reservation period.
 - Auto Sleep/Auto Power-OFF: timer re-activates after the reservation period is up.
 - Power-OFF Schedule: Will not shut off until next day on time.
- ☞ p.162

1 Touch [Functions] on the Master Making Basic Screen.

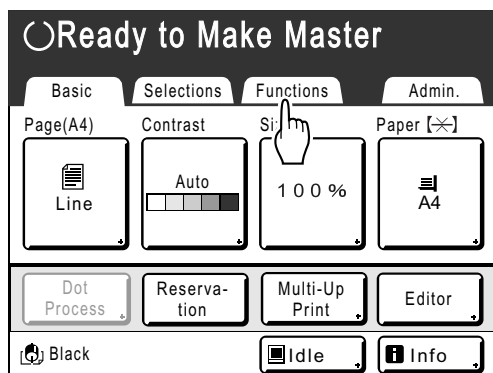

2 Touch [Reservation].

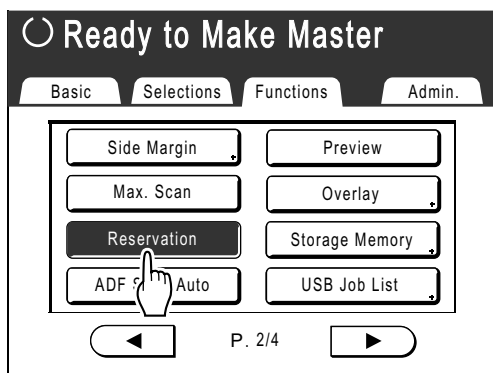

Reservation period is extended.

Idling Action [Idling Action]

When the machine has not been used for an extended period of time, or when the Print Drum (Cylinder) is replaced, the first several copies may be printed too light. By performing "Idling Action" before making a master, high print quality may be instantly achieved and reduce paper waste.

Important!:

- "Idling Action" is effective only in conjunction with the master-making process. When performing print processes only, "Idling Action" will have no effect.

Note:

- To perform "Idling Action" automatically when making a master after a specified period of time since the last print job, set "Auto Idling" on the Admin. screen.
p.163

1 Touch [Functions] on the Master Making Basic Screen.

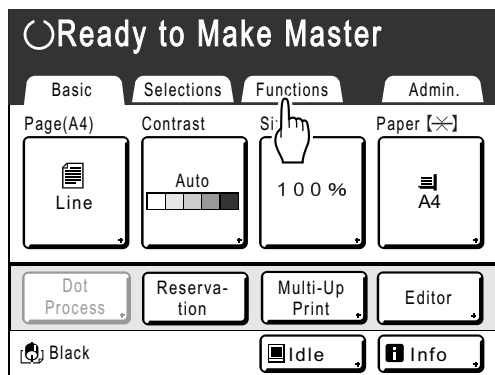

The following screen appears.

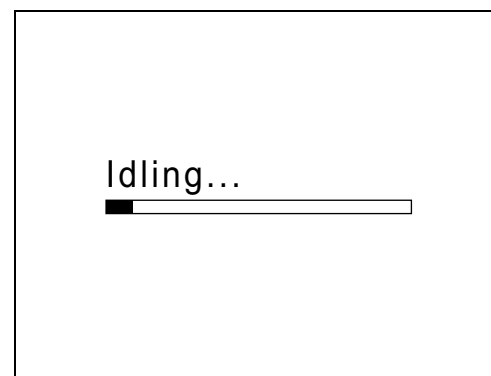

After "Idling Action" has been finished, the master-making process is started.

Note:

- Remember to load the originals before pressing the **START** key as the master will be made immediately after "Idling Action" finishes.
- If **i** displays in the screen message area even though it is not set, this indicates that the "Auto Idling" time has elapsed. If you make a master in this status, "Idling Action" is executed.

2 Touch [Idling Action].



i appears on screen.

3 Press the **START** key.

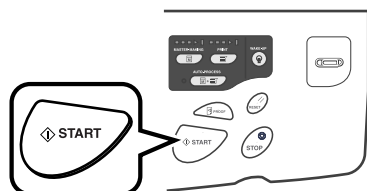

Reproducing the Master

[Renew Page][Auto Page Renewal]

The data from the last master-making process is temporarily stored on the machine.

Using this data, another master can be reproduced without repeating steps to scan the same original.

You can “Rotate” the original and recreate a master.

“Auto Page Renewal” is a function that automatically recreates a master when a specified number of pages are printed. If you are printing a large-volume job of thousands or tens of thousands of copies, the master may degrade before the job is completed.

If you set “Auto Page Renewal” to “ON” prior to starting a large-volume print job, a master will be automatically re-created when the specified number of copies is reached (Auto Renewal Point). This allows you to maintain a consistent print quality from start to finish.

Note:

- “Renew Page” works with data sent from a computer as well. However, if multiple pages exist, only the last page will be processed with “Renew Page”.
- “Renew Page” function is not available:
 - immediately after startup
 - after pressing the  key
 - after executing “Auto Clear” (“Changing Default Setting” p.161)
 - after performing “Confidential”
 - after performing “Multi-Up Print”
 - after performing “Book Shadow”
 - when an error has occurred during master-making
 - after performing “Link Print”
 - after master-making for Data Output Mode (when the optional Key Card Counter is installed.)
 - after Idling Action has been executed, excluding with following conditions.
 - displaying the preview
 - overlaying
 - while in “Book” mode
- The number of pages in the proof copy when using “Auto Page Renewal” can be adjusted using “Admin.”. p.163
- Once the print position has been adjusted the new position is saved when master-making is resumed, avoiding the need for readjustment.

Using Page Renewal

1 Touch [Functions] on the Print Basic Screen.

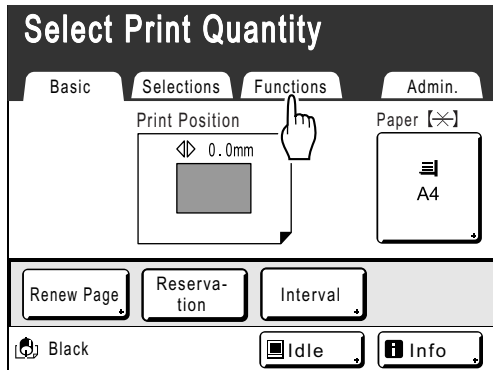

2 Touch [Renew Page].

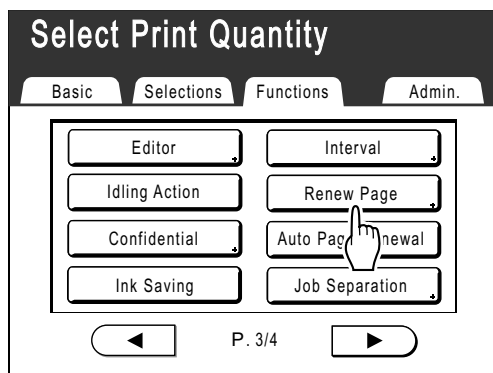

Note:

- If you touch and select **[Rotate]**, you can rotate the original 180 degrees for renewing the master.
- When "Rotate" is set, the machine rotates 180 degrees for renewing the master while executing "Auto Page Renewal".

- To cancel "Rotate", touch **[Rotate]** again.

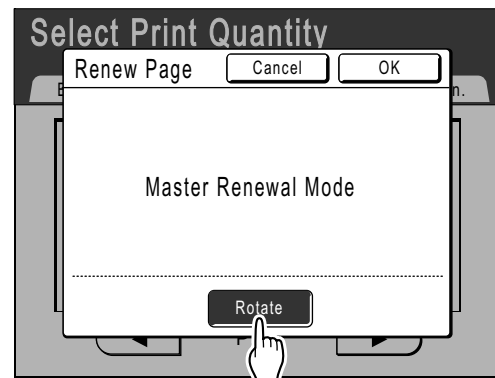

3 Touch [OK].

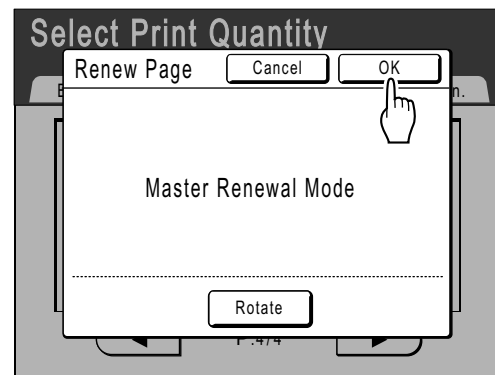



"Renew Page" begins reproducing the master.

Advanced Features

Using Auto Page Renewal

In order to use “Auto Page Renewal”, you must enable it in “Admin.” prior to use. If “Auto Page Renewal” is activated and “Auto Page Renewal” is set to “ON”, “Auto Page Renewal” can be executed during a print job.

Important!:

- If “Auto Page Renewal” is not activated in “Admin.”, “Auto Page Renewal” cannot be set to “ON”. [p.163](#)
- The “Auto Page Renewal” is set to “OFF” in the following instances.
 - When printing with “Program”
 - When the  or the  is pressed
 - When attempting to process the next job with direct print

Note:

- The factory settings are such that a master is recreated every 1000 copies, with a setting to print 3 proofs. This setting can be changed in “Admin.”. [p.163](#)

Turning ON “Auto Page Renewal”

- 1** Touch [Functions] on the Print Basic Screen.

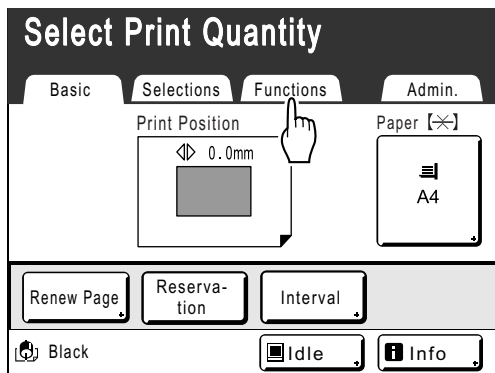

When you print with these settings, “Auto Page Renewal” will be executed after the specified number of copies are printed.

Note:

- If [Auto Page Renewal] is grayed-out, go to “Admin.” and turn “Auto Page Renewal” ON. [p.163](#)

- 2** Touch [Auto Page Renewal].

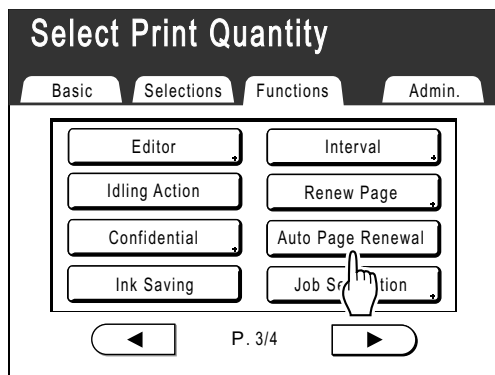

“Auto Page Renewal” is activated.

Proof and Print

(with the ADF unit (Option) installed)

[ADF Semi-Auto]

Selecting “Auto Process” with the ADF unit (Option) installed automatically performs the complete printing job, but you cannot make proof copies, or any necessary adjustments of each master. To pause for check after printing a proof copy of each master, select “ADF Semi-Auto”.

Important!:

- Turn “Auto Process” OFF when using “ADF Semi-Auto”.
p.64

Note:

- The default “ADF Semi-Auto” can be set on the Admin. screen.
p.159

1 Touch [Functions] on the Master Making Basic Screen.

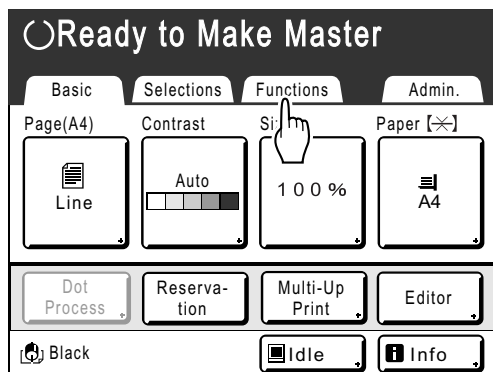

2 Touch [ADF Semi-Auto].

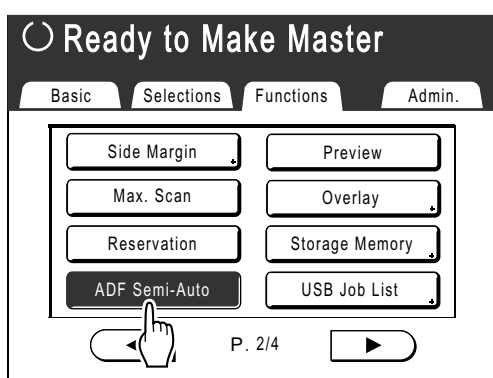

“ADF Semi-Auto” is selected.

3 Place original(s) in the ADF unit (Option).

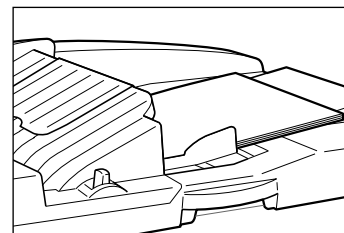

The ADF unit (Option) detects the document, and automatically opens the Master Making Basic Screen

4 Enter the number of copies using the Print Quantity Keys.

The number is displayed on the Print Quantity Display.

Note:

- To change the number, press the **C** key, then re-enter the correct number.

Advanced Features

5 Press the key.

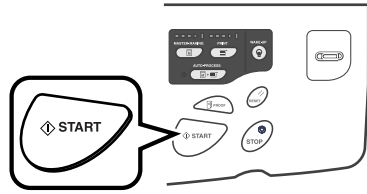

After a master is made, a proof copy is printed and the job stops.

6 Check the proof copy.

Make adjustments if needed.

7 Press the key.

The machine prints specified number of copies. Master for the next original is made, its proof copy is printed, then the machine stops again.

Repeat steps 6 and 7.

Showing Usage Status [Meter Display]

The machine can record and display the following information:

- A4/Letter and Under: Total number of copies A4/Letter-sized and smaller that have been printed.
- Above A4/Letter: Total number of copies larger than A4/Letter that have been printed.
- Total: The total number of copies printed by the machine.
- A3/Ledger Master Count: Total number of A3/Ledger-sized masters that have been made.
- A4W/LetterW Master Count: Total number of A4W/LetterW-sized masters that have been made.
- Master Count: The total number of masters made by the machine.
- Print Drum (Cylinder) Meter: The number of copies that have been printed with the current drum (cylinder).
- Job Count: Start and stop as needed.

For example, to keep track of the number of copies made in a day, set “Job Count” to 0 in the morning, and check the counter at the end of the work day to get the count.

Note:

- When using more than one Print Drum (Cylinder), install the Print Drum (Cylinder) for which you need information before displaying the Meter Display screen.

1 Touch [Functions] on the Master Making Basic Screen.

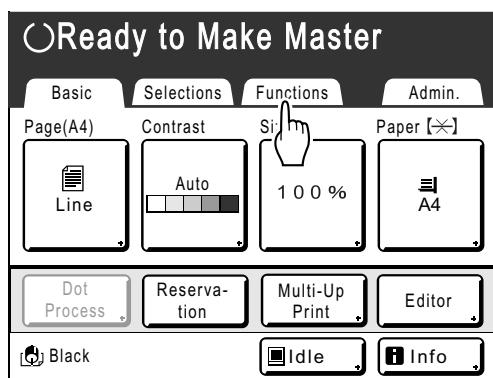

2 Touch [Meter Display].

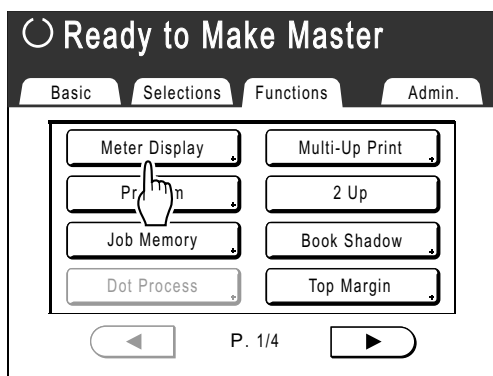

3 Review counts.

Meter Display		Close
A4/Letter and Under	0	
Above A4/Letter	0	
Total	0	
A3/Ledger Master Count	0	
A4W/LetterW Master Count	0	
Master Count Total	0	
Print Drum Meter	0	
Job Count	0	◀C

Note:

- Using the “Job Count”
 - 1) Touch **◀C** to set the counter to 0.
 - 2) Touch **Close** to close the Meter Display screen. Operate the machine as normal.
 - 3) To display and review the Job Count, follow steps 1 and 2.

4 Touch [Close] to close the window.

Returns to the Function screen.

Advanced Features

Rotating the Original 180 Degrees to Make a Master [Rotate]

When you are direct printing, you can rotate the original data received from a computer 180 degrees to make a master. When this function is used for the original data of a wide range of solid colors (colours) on the top side, you can prevent paper jams.

After the machine receives the original data, touch [Rotate] on the Functions Screen.

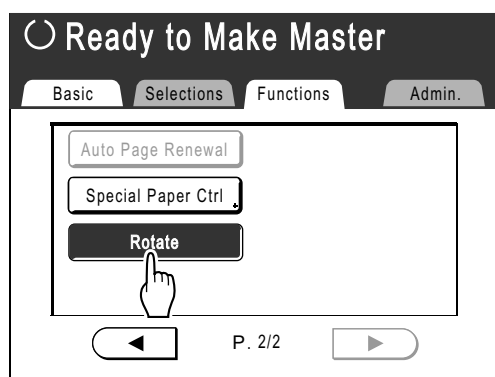

"Rotate" setting is updated.

Note:

- When you send the original data from a computer, set "Auto Process" to **[OFF]** or **[Pause before "Master"]**.

Checking User Counters [ID Counter Report]

Each user can output counter data (number of prints, etc.) when checking usage status.

Important!:

- “ID Counter Report” can be outputted only when the “User Management” function is set.

◆ Report Output

Counter data can be outputted by following methods.

- Print
Prints the counter data.
- E-mail
E-mail attached with the counter data is sent to the e-mail addresses set as the destination.
The mail settings must be set in advance. For details on mail settings, the RISO Network Card is required. For details, see the “RISO Network Card User’s Guide”.
- USB Flash Drive
Outputs the counter data to the USB Flash Drive.
USB Flash Drive must be connected to the USB slot in advance.

Note:

- By using the “RISO Utility Software” (RISO COPY COUNT VIEWER) included on the provided CD-ROM, the counter data output to the USB Flash Drive can be managed by a computer.
For details, see the “RISO Utility Software User’s Guide”.

Setting the reminder date

For regular counting, a reminder date can be set.
The following screen is displayed on the set date.

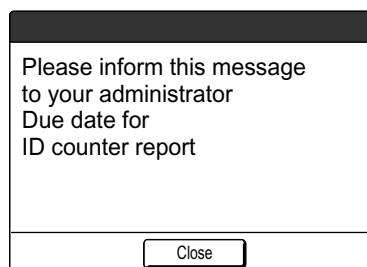

Important!:

- To manage usage status correctly, the following setting is required. If you do not make the following setting, you cannot count the number of prints/masters correctly.
 - Set **[Management Level]** to **[High/Full Management]** in User Management. [p.106](#)
 - If you print from the computer, be sure to use “ID Print”. See the “RISO Printer Driver User’s Guide” for detail.

Advanced Features

Outputting the Counter Report

1 Touch [Functions] on the Basic Screen for each mode.

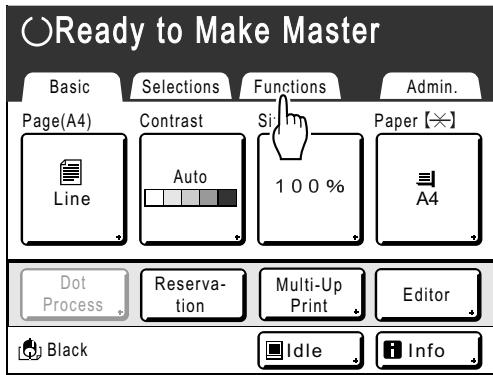

2 Touch [ID Counter Report].



3 Touch the button of the desired output method.

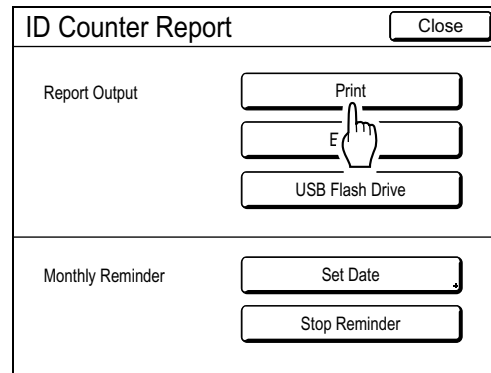

Returns to the Basic screen after output.
If the mail setting is not set, **[E-mail]** is not available.

Consult your dealer (or authorized service representative) about mail settings.

If the USB Flash Drive is not connected, **[USB Flash Drive]** is grayed-out and is not available.

Setting Up the Monthly Reminder

- 1 Touch [Functions] on the Basic Screen for each mode.**

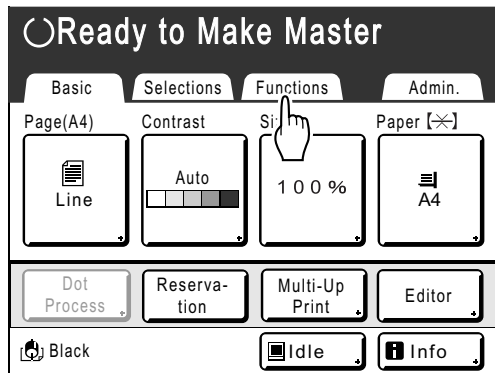

- 2 Touch [ID Counter Report].**



- 3 Touch [Set Date].**

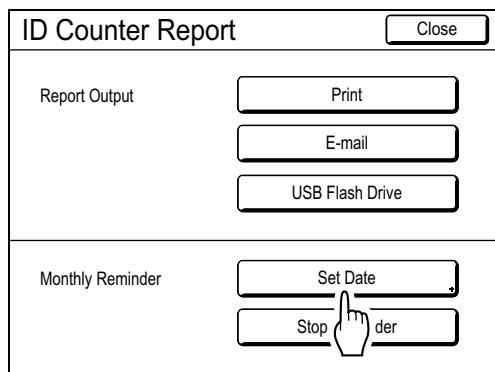

- 4 Touch ▲ or ▼ to set the reminder date.**

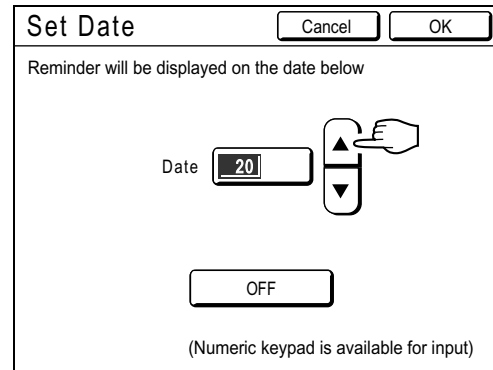

If the [Date] button is grayed-out, touch [OFF] and input the date.

Note:

- Print Quantity Keys can also be used to enter numbers.
- The set date can be selected between 1 and 31.
- When setting the reminder date between the 29th - 31st, and if the number of days in the month is less than this range such as in February, the reminder screen is displayed on the last day of the month.
- If you are not setting the reminder date, touch [OFF].

- 5 Touch [OK].**

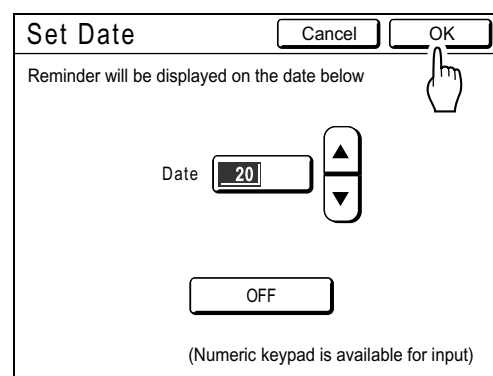

Returns to the ID Counter Report screen. The reminder date is updated.

Advanced Features

6 Touch [Close].

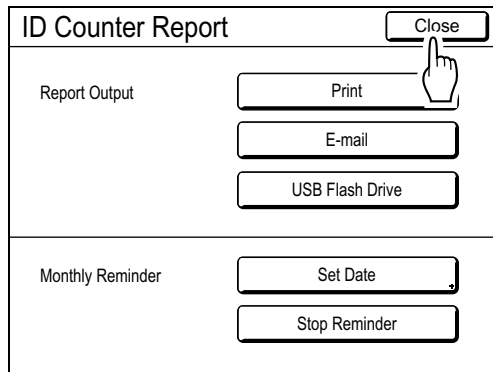

Returns to the Functions screen.

Note:

- Once the reminder date is set, a “reminder screen” is displayed on each reminder date. In fact, this message is displayed each time the machine is turned ON until the counter report is output. If you do not want to output the counter data on the set date of this month, touch **[Stop Reminder]**. The reminder screen is not displayed until the reminder date of the next month.

Customizing the Direct Access Area

[My Direct Access]

Normally, the functions displayed in the Direct Access Area of the Basic Screen are already registered by default setting or changed by the administrator. However, if User Management is set up, each user can register the functions displayed in the Direct Access Area using "My Direct Access".

The functions that can be displayed in the Direct Access Area can individually be registered in each mode (Master Making/Print/Scanning).

Up to 4 functions can be registered.

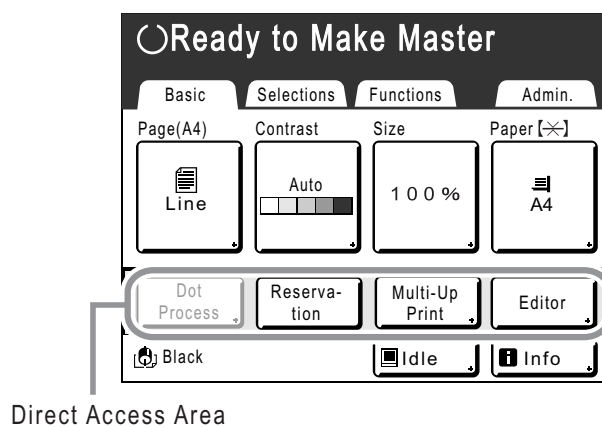

"My Direct Access" kept by each user can be displayed after the user has been identified and cannot be changed by other users.

Note:

- "My Direct Access" can be set when "Management Level" is set to "High/Full Management" in "User Management".
- If "My Direct Access" is not set, the functions registered via the usual methods are displayed in the Direct Access Area. (p.168)

1 Touch [Functions] on the Basic Screen for each mode.

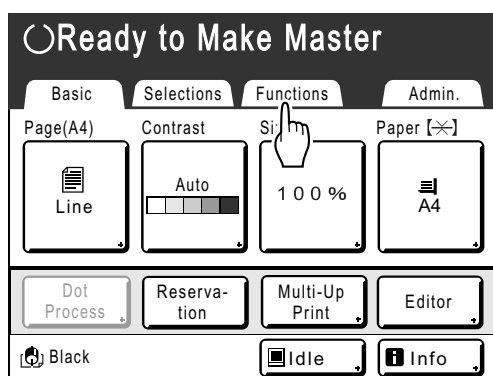

2 Touch [My Direct Access].



If "Management Level" is not set to "High/Full Management" in "User Management", the **[My Direct Access]** button is grayed-out and is not available.

Note:

- Consult your administrator for Management Level.

Advanced Features

3 Select a mode tab to register new buttons.

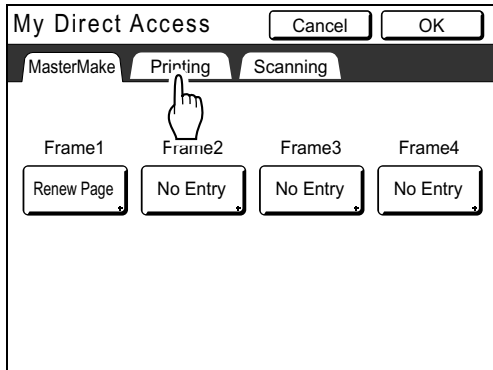

4 Select a button to assign a function to.

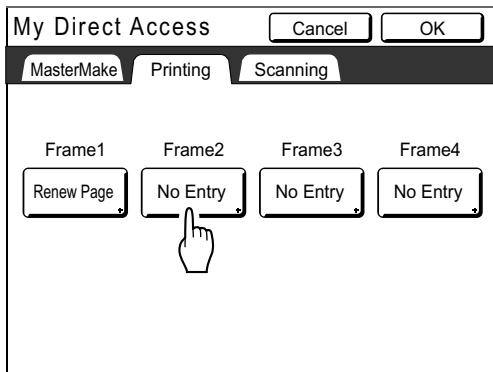

If the button has a function already assigned to it, the newly selected function will overwrite the previous function.

5 Select a function to assign.

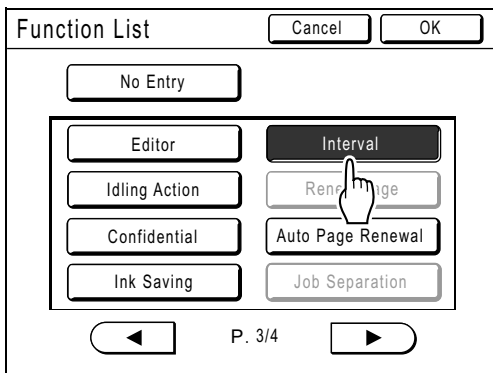

Note:

- Touch ◀ or ▶ to display more functions if necessary.
- To remove a function that is accidentally assigned, touch **[No Entry]**.
- Functions already assigned are grayed-out and are not available.
- Some functions display only when optional devices are installed.

6 Touch [OK].

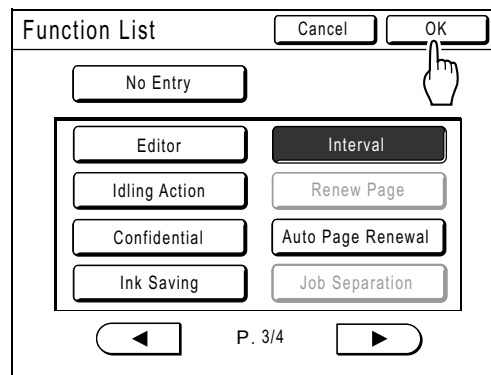

Returns to “My Direct Access” screen. The selected functions are added. To add more functions or to replace a button with another function, repeat step 3 to 6.

7 Touch [OK].

Returns to the Functions screen.

Changing Default Settings [Admin.]

The default settings can be modified to best suit your needs. They may be edited as needed.

Important!:

- If the administrator is registered in User Management, only the administrator can change the **[Admin.]** settings. (This operation requires input of the administrator's PIN code or connection of the registered USB Flash Drive.)
☞ p.165, ☞ p.106
- Depending upon the usage environment, the "Admin." features may not be available (the "Admin." tab may not be displayed).
 Consult your dealer (or authorized service representative) for details.



Note:

- The default settings are the values restored when the machine is turned ON or when the  key is pressed.

Configurable Functions

 : Initial setting (factory default)

* This function can be set only when the option is installed.

Display Access Button	Functions	Description
[Display]	DirectAccess Entry Store frequently-used functions on the Basic Screen for each mode.	<small>☞ p.168</small>
	Selections Entry Store frequently-used functions on the Selections screen for each mode.	<small>☞ p.168</small>
	Display Priority Select first screen to display following the Startup. Note: • The Mode Screen is available only when "Mode Key Pattern" is set to "Mode Selection".	Mode Screen/RISO Print/ (Scanning)
	Mode Key Pattern Select screens to display when the  key is pressed. [Mode Selection] Pressing the  key will open the Mode Screen no matter which screen you are currently on. [Loop] The screen changes as shown below when the  key is pressed. • Normally: "Master Making Basic Screen" ↔ "Print Basic Screen" • When a Linked Printer is connected: "Link Basic Screen" ↔ "Master Making/Print Basic Screen" • When the optional Document Storage Card or USB Flash Drive is attached: "Scan Basic Screen" ↔ "Master Making/Print Basic Screen"	Mode Selection/Loop





Advanced Features

Display Access Button	Functions	Description
[Display]	Start-Up Screen Select an animation to display at Start-up.	Logo(RISO)/ <u>Logo(EZ)</u> /Character
	Metric/Inch Switch (For EZ591U only) Change the format for displaying measurements to metric or inches (imperial).	<u>Inch</u> /Metric
	Display Adjustment Change background color (colour), density and brightness of the Touch Screen. When the "ECO mode" is set to "ON", the background brightness of the Touch Screen is locked to "-2".	Background: <u>White</u> /Blue Display Density -5, -4 ... -1, <u>0</u> , +1 ... +4, +5 Backlight Lightness: -2, -1, <u>0</u> , +1, +2
	Job list display Change the file name display of the stored data in Storage Selection Screen, Job List Screen and USB Job List Screen.	<u>From top</u> , From bottom
	Displayed Language Select the language displayed on the screen. Important! • Contact your dealer (or authorized service representative) to change the settings.	#01, #02, #03 ...

Display Access Button	Functions	Description
[Default]	Image Processing Change the default setting for the "image processing mode".	<ul style="list-style-type: none"> • <u>Line</u> • Photo (Standard, Portrait, Group) • Duo (Line, Photo/Shadow off) • Pencil (Darker, Lighter)
	Scanning Contrast Change the default setting for the "scanning contrast".	<ul style="list-style-type: none"> • Contrast Range: Lighter/<u>Standard</u>/Darker • Contrast: 1, 2, 3, 4, 5, <u>Auto</u>
	Reproduction Size Change the default setting for the "size".	<u>100%</u> , Auto
	Print Speed Change the default setting for the "print speed". When the "ECO mode" is set to "ON", the initial setting cannot be changed.	1, 2, <u>3</u> , 4, 5
	Print Density Change the default settings for the "print density". When the "ECO mode" is set to "ON", the initial settings cannot be changed.	<ul style="list-style-type: none"> • Print Density Level: Lighter, <u>Standard</u>, Darker • Print Density: 1, 2, <u>3</u>, 4, 5
	OP Auto Process * Change the default setting for the "Auto Process" when an ADF unit (Option) or Job Separator is installed.	<u>ON</u> , OFF
	ADF Semi-Auto * Change the default setting for the "ADF Semi-Auto" when the ADF unit (Option) is installed.	ON, <u>OFF</u>
	Auto Process Mode * Change the default setting for the "Auto Process".	ON, <u>OFF</u>
	Job Separation * Change the default setting for the "Job Separation" when the Job Separator (option) is installed.	ON, <u>OFF</u>

Advanced Features

Display Access Button	Functions	Description
[Default]	Jump Wing Control Change the default positioning of the Paper Jumping Wing. Important! • This option is available only when the special paper setting is pre-configured. Contact your dealer (or authorized service representative) to pre-configure this setting.	ON, <u>OFF</u>
	Paper Ejection Adj Change the default settings for "Paper Ejection Adj." ☞ p.98	Separation Fan: OFF, 1, <u>2</u> , 3, 4 Suction Fan: 1, 2, <u>3</u> , 4
	Default Folder * When the optional Document Storage Card is attached, change the folder in which to save the data scanned in the scan mode and the folder to save the data sent from the computer.	<ul style="list-style-type: none"> • Scan Data Folder: 1-6 folder (Factory default: 1_folder) • PC Job Folder: 1-6 folder (Factory default: 1_folder)
[System]	Custom Paper Entry Specify paper dimensions before using non-standard sized paper.	☞ p.170
	Fixed Scan Size Scan the original at the specified standard size regardless of the set original size.	For EZ591: <u>OFF</u> , Ledger, Legal, Letter, LetterR, Statement, Statement R For EZ571/EZ531: <u>OFF</u> , A3, B4, A4, A4R, B5, B5R, Foolscap
	Folder Renaming * When the optional Document Storage Card is attached, changes the folder name of the folder used to save data.	1-6 folder
	CI Select Choose between "Internal CI" and "External CI" settings.	<u>Internal CI</u> , External CI

Display Access Button	Functions	Description
[System]	<p>External CI Info *</p> <p>If the machine is equipped with the optional IS300, set the IP address to connect the machine to the network. IP address settings differ depending on the type of network.</p> <p>Note:</p> <ul style="list-style-type: none"> To change an input source, touch the applicable box, or press the  key to rotate options. If the message "Network Communication is Not Possible" is displayed when touching [External CI Info], touch [Cancel] and wait for the IS300 to finish starting up, then try again. 	<ul style="list-style-type: none"> When using a DHCP server [Use DHCP] When entering IP address manually [Manual Input]   or the Print Quantity Keys.
	<p>Base IP Address</p> <p>Set the IP address for connecting the machine to a network. IP address settings differ depending on the type of network.</p> <p>Note:</p> <ul style="list-style-type: none"> To change an input source, touch the applicable box, or press the  key to rotate options. If the message "Starting Up Network Card" is displayed when touching [Base IP Address], touch [Cancel] and wait for the RISO Network Card (Option) to finish starting up (approx. 1 minute), then try again. 	
	<p>Margin-Plus Rate</p> <p>Specify default size-reduction rate for the "Margin+" setting.</p>	<p>90 to 99 % (Factory default is 94%)</p>
	<p>Clock/Calendar</p> <p>Set the internal clock of the machine. The time/date displays on the  Info screen. p.207</p>	<p>Year/Month/Day Hour:Minute (Day/Month/Year Hour:Minute)</p>
	<p>Multi-Up Interval</p> <p>Select the interval time (seconds) between first and second scans when using Multi-Up Printing.</p>	<p><u>15s</u>/30s</p>
	<p>Reserve Period</p> <p>Select a duration of time (seconds) for the inactive machine to receive data from a computer but restricts processing any output command.</p>	<p>OFF/<u>15s</u>/30s/60s</p>
	<p>Ex. Reserve Period</p> <p>When "Reserve Period" is set, extends the Reserve Period (minutes) to prevent data interruption.</p>	<p><u>5mn</u>/10mn/30mn</p>
	<p>Auto Clear</p> <p>Select whether to reset all settings to default automatically when the machine is inactive for a set period (minutes).</p>	<ul style="list-style-type: none"> Auto Clear OFF/<u>ON</u> Waiting Time 1-60 mn (factory default is 5 mn)

Advanced Features

Display Access Button	Functions	Description
[System]	<p>Energy Saving Mode Select to activate Sleep Mode or Shutdown Power when the machine is inactive for a set period of time.</p> <ul style="list-style-type: none"> • OFF “Energy Saving Mode” is not activated. Power is turned ON/OFF using the power switch. • Auto Sleep The machine is standing by to receive data from the computer, but the rest of its functions are powered off. • Auto Power-OFF Automatically shuts the power off. (Data cannot be received.) 	<ul style="list-style-type: none"> • Energy Saving Mode OFF/<u>Auto Sleep</u>/Auto Power-OFF • Waiting Time 1-60 mn (factory default is 5 mn)
	<p>Power-OFF Schedule Set a time of the day to automatically shut power to the machine off. If the machine is in use, or receiving data, power will not shut off.</p>	<ul style="list-style-type: none"> • Power-OFF Schedule <u>OFF/ON</u> • Shut-Off time Hour: Minute
	<p>ECO mode This mode makes the printing pressure and the LCD touch panel brightness lower than those in the normal printing mode, thus reducing power consumption in printing. When “ON” is selected, the default values for the “print speed” and the “print density” cannot be changed. When this machine is in the ECO mode, the “ECO mode” icon appears.</p> <p>Note:</p> <ul style="list-style-type: none"> • When both the “ECO” and “Ink Saving” modes are selected, the “Ink Saving” icon appears. 	ON, <u>OFF</u>
	<p>User Management Set the User Management function.</p> <ul style="list-style-type: none"> • Management Level Set the “Management Level”. • Create User Register the administrator and users of this machine. • Rename Group Change the group name. • Reset Counter Reset all user counters for master-making/printing. • Recognized by Set the Recognition and Identification System. 	p.106
	<p>Protect Determine the “Protect” setting.</p>	<u>OFF</u> , ON p.173

Display Access Button	Functions	Description
[System]	<p>Auto Idling Select whether to perform "Auto Idling" when making a master after a set period of non-use. Also selects a period of non-use before initiating "Auto Idling", as well as the number of idle rotations.</p>	<ul style="list-style-type: none"> • Auto Idling <u>OFF/ON</u> • Non-Use Time <u>1-12 hour</u> • Rotation <u>1-3 (times)</u>
	<p>Auto Page Renewal Allows you to set when to recreate a new master. Once the specified number of copies is reached, the master in use is automatically discarded and a new one created. You can also specify the number of proof copies to make after recreating the master.</p>	<ul style="list-style-type: none"> • Auto Page Renewal <u>OFF, ON</u> • Auto Renewal Point 1-9999 copies (Factory default is 1000 copies) • Sample Copy Output 0-99 copies (Factory default is 3 copies)
	<p>Minimum Print Q'ty Set minimum number of copies to print. This prevents master from being made when a smaller quantity is entered for printing.</p> <p>Important!:</p> <ul style="list-style-type: none"> • This setting can be locked to prevent alteration. Consult your dealer (or authorized service representative) for details. 	<p><u>OFF/ON</u> (2-99 copies)</p>
	<p>Stock Management In order to check current stock quantity, insert the number of consumables purchased.</p> <p>Note:</p> <ul style="list-style-type: none"> • When stock quantity falls below the "Remaining Qty to be notified", a message will appear on the display. • This setting is disabled by factory default. Consult your dealer (or authorized service representative) for details. 	<ul style="list-style-type: none"> • Purchase Qty <u>0-99 Pcs.</u> • Remaining Qty to be notified <u>0-99 Pcs.</u>
	<p>Initialize Network * Initialize the network setting and return to the factory setting when the RISO Network Card (Option) is installed.</p>	<p>See RISO Network Card User's Guide for details.</p>
	<p>Beep Sound Select whether to activate a beep sound when a key/button is pressed, or when an error occurs.</p> <ul style="list-style-type: none"> • ON Beeps when any key/button is pressed. Beeps when an event is caused/completed. • Limited Does not beep when keys/buttons are pressed. Does not beep when restarting the machine. • OFF Does not beep. 	<p>OFF/Limited/<u>ON</u></p>

Advanced Features

Display Access Button	Functions	Description
[Link Mode] Only displayed when a Linked Printer is connected.	Link Properties	p.193
	Linked Printer If only one Linked Printer is attached to the machine (there are no other Linked Printers or networked computers), it is "One-to-One".	PC Network , One-to-One
	Link-Free Volume Set a number of copies by which the output device is determined. When print quantity does not reach the set value, the job is to be output from a Linked Printer. When printing more copies than Link-Free Volume, the machine will perform printing. Note: <ul style="list-style-type: none"> This function is not available for EZ591. The default value is 20 copies. "Minimum Print Q'ty" cannot be set when "Link-Free Volume" is ON. 	ON [Link-Free Volume] 2-99 copies/OFF (Factory default is 20 copies)
	Duplex Interval Select the interval time (seconds) between first and second scans when using Double-sided Printing.	15 seconds /30 seconds
	Online Auto-Link Select whether to automatically output a job from the Linked Printer when print quantity is less than Link-Free Volume. Note: <ul style="list-style-type: none"> This function is not available for EZ591. When "Link-Free Volume" is OFF, this item is grayed out and not available. 	OFF/ ON
	Link Info Refresh Set how frequently the machine receives data from a Linked Printer.	10-999 seconds (Factory Default is 15 seconds)
	Link Scanning Mode You can select "Speed-based" or "Image-based" when outputting from a connected machine.	Speed-based , Image-based
[Editor]	Print Colors (Colours)	See RISO Editor User's Guide for details.
	Tool Bar Position	
	Sub Tool Bar	
	Page Orientation	

Customizing the Default Settings

The default settings can be changed when the machine is not in operation. Make sure there is no pending or current Print Job operation.

Note:

- If the administrator is registered in User Management, only the administrator can change the [Admin.] settings. (This operation requires input of the administrator's PIN code or connection of the registered USB Flash Drive.) See p.106
- On the Admin. screen, the current setting is displayed on the right side of each button.

1 Touch [Admin.] on the Basic Screen for each mode.

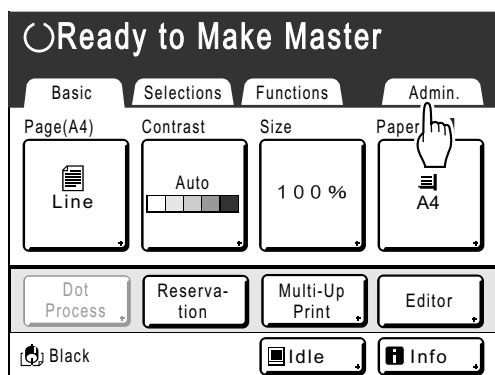

2 Touch [OK].



Note:

- When an administrator is registered in User Management, the Recognition Screen is displayed. Operate the screen to log in as the administrator. If already identified as the administrator, the Recognition Screen will not be displayed. Users other than administrator are prohibited.

◆ When “Recognized by” is set to “PIN code”

Input the administrator's PIN code using the Print Quantity Keys and touch [OK].

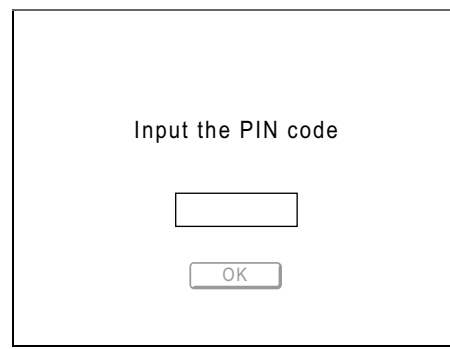

◆ When “Recognized by” is set to “USB Flash Drive”

Connect the administrator's registered USB Flash Drive to the USB slot.

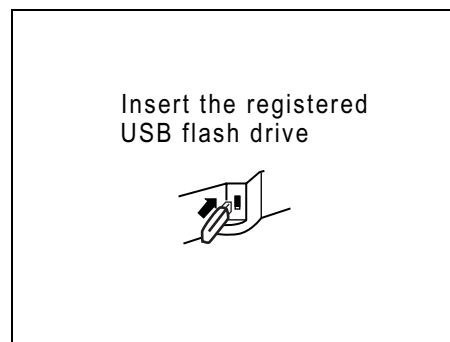

The Admin. screen is displayed once access has been identified.

Advanced Features

3 Select a function to modify.

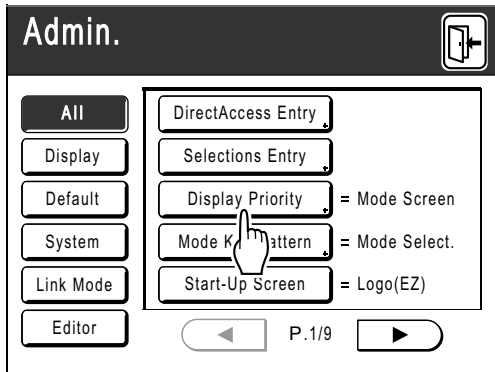

Display Access Buttons

Display Access Buttons allow for quick selection of desired functions by displaying only relevant groups of function buttons.

- [All]: All Functions
- [Display]: Functions related to Screen Display
- [Default]: Basic Operational Functions
- [System]: Functions affecting the entire System
- [Link Mode]: Functions related to Linked Printer
- [Editor]: Functions related to Editor

- [Link Mode] is only displayed when a Linked Printer is connected.

4 Change settings.

Some functions have their own Setup screens, some don't. There are several styles for setting values. Following samples demonstrate different value setting styles.

◆ No additional Setup Screen

(2 or more options to choose from)

Touch the function name button to change the value displayed to the right.

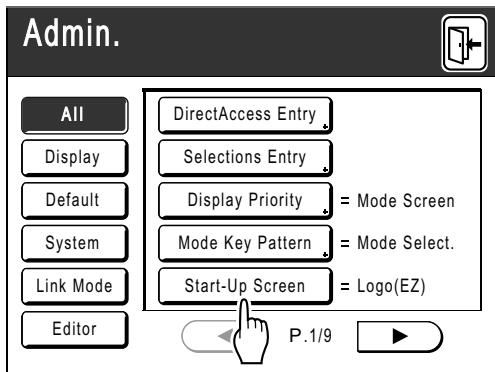

Once the settings have been changed, continue on to step 6.

◆ Additional Setup Screen Available

Button Style

Choosing a button makes it the default.

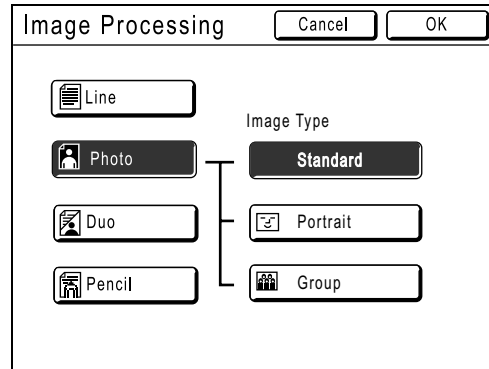

◆ Additional Setup Screen Available

Numeric Value Style

Touch ▲ ▼ to increase/decrease value. Numbers may be entered using the Print Quantity Keys.

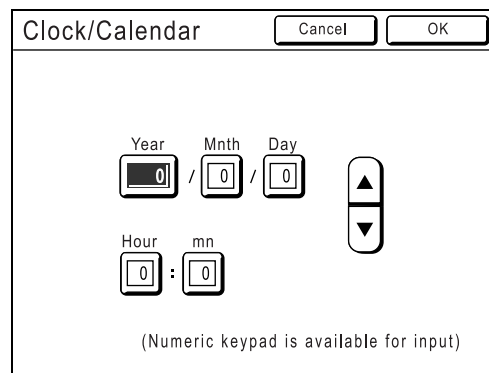

◆ Additional Setup Screen Available

Multi Level Entry Style

Select a button, then set its values either by touching more buttons or entering a value numerically.

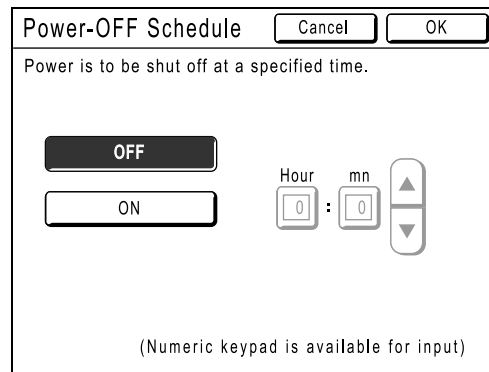

The following screen appears.

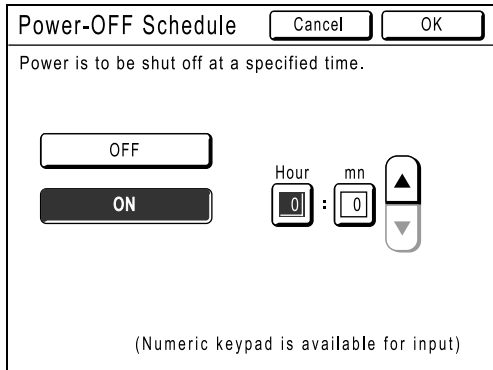

Touch **[ON]** to display more options on the right.

◆ **Additional Setup Screen Available**

Text Input Type

Input the name after touching the button of the name to change.

Touch the button and the Rename screen appears.

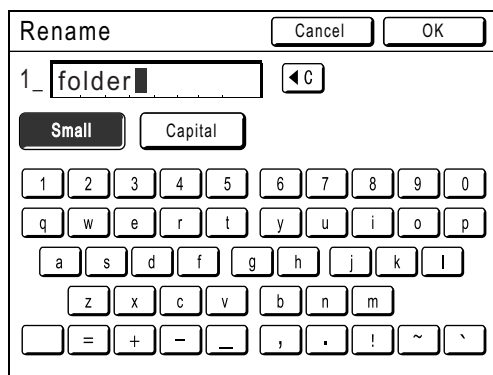
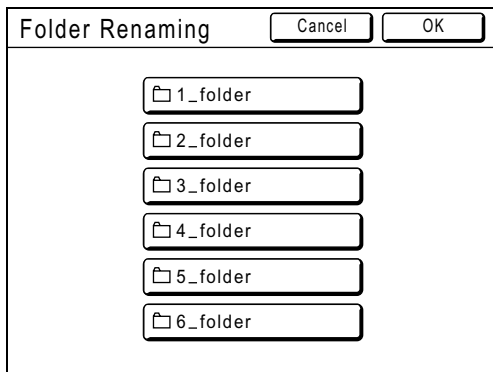

Touch the character buttons to enter text. Change capitalization by selecting the **[Small]** or **[Capital]** button.

☞ p.130

◆ **Additional Setup Screen Available**

Data Specification Type

A screen to specify the stored data displays. See ☞ p.183 for details on specifying the data.

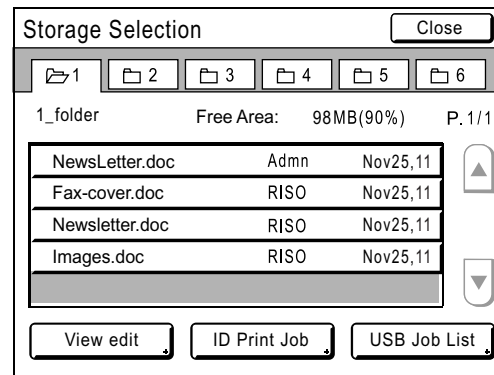

5 Touch [OK].

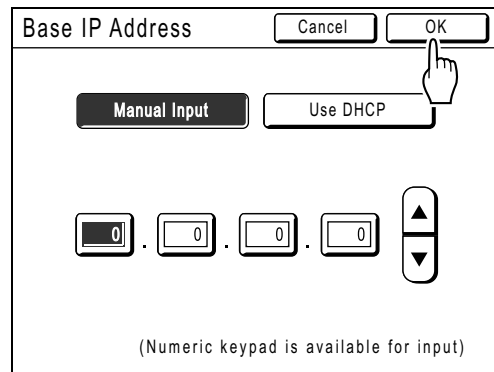

Skip to step 6 if there is no additional setup screen.

Note:

- Touch **[Cancel]** to cancel the changes and return to the Admin. screen.
- The selected value is displayed to the right of the button (for most functions).

6 Touch [Home].

Returns to the original Basic Screen.

Advanced Features

Setting Up Direct Access Area and Selections Tab

[Direct Access Entry] [Selections Entry]

Frequently-accessed functions for each mode can be placed on “Direct Access” area in the Basic Screen, or on “Selections” screen.

This allows quick changes and direct access to each function's Setup screens, eliminating the need to search from a long list of functions.

Each mode (Master Making/Print/Scanning/Link) is capable of storing its own unique settings.

Basic Screen	Master Make	Print	Scanning	Link
Direct Access	4	4	4	4
Selections	9	9	-	6

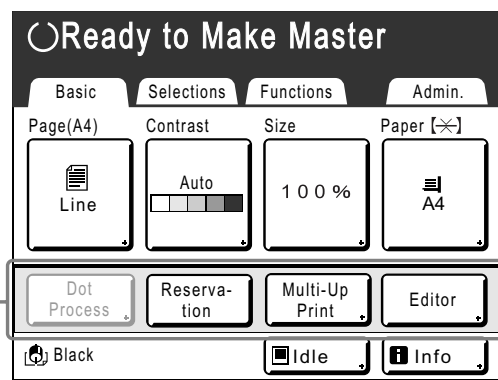

Direct Access Area

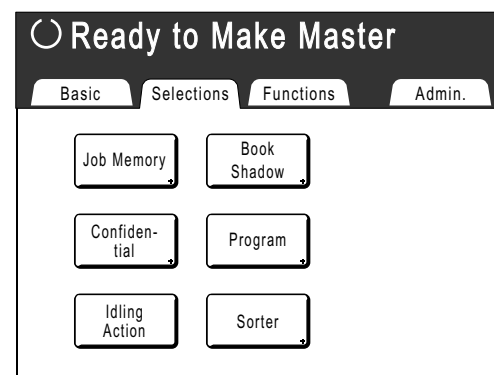

Selections Screen

Note:

- Choose functions that are relevant to each mode.
- The machine comes with factory default “Direct Access” area and “Selections” screen entries, which can be changed.
- Any functions available in the “Functions” screen can be selected.
- When there are multiple Linked Printers, select a device first, then make changes in the “Admin.” tab to select/mod-ify “Direct Access” area and “Selections” screen.
- Optional attachment is automatically added to the “Direct Access” area and “Selections” tab if a space is available for another button.
(Optional devices to a Linked Printer must be entered on the Admin. screen.)
- When the Management Level is set to “High/Full Management”, each user can set the functions displayed in the Direct Access Area (My Direct Access). See, p.155.

In the following steps, the registration on DirectAccess Entry and Selections Entry are explained at the same time.

1 Touch [DirectAccess Entry] or [Selections Entry] on the Admin. screen.

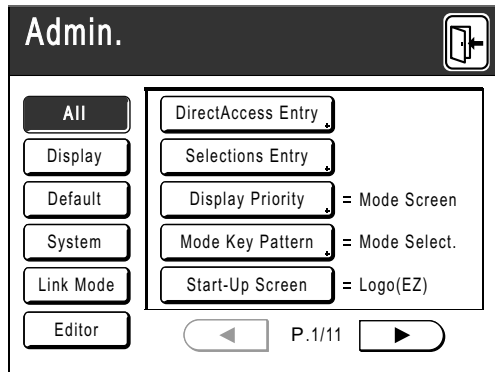

2 Select a mode tab to store new buttons.

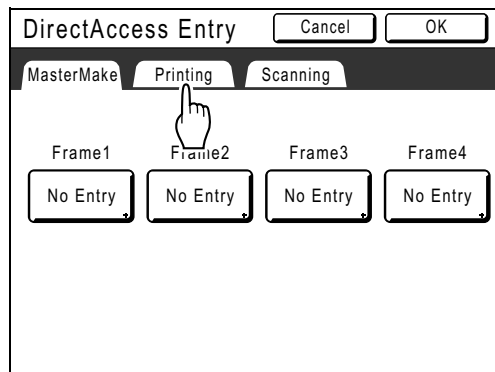

3 Select a button to assign a function.

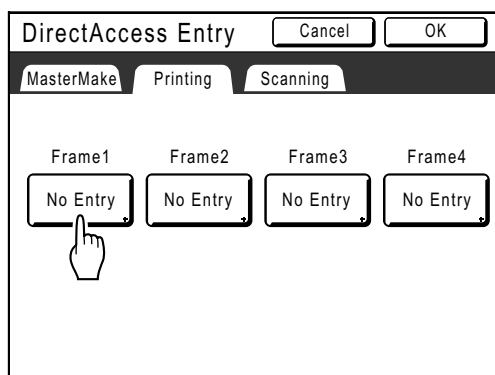

If the button has a function already assigned to it, the newly selected function will overwrite the previous function.

4 Select a function to assign.

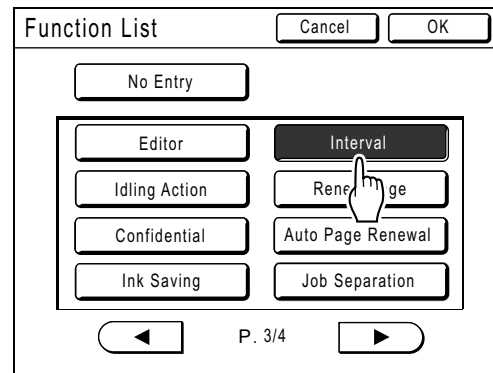

Note:

- Touch ◀ or ▶ to display more functions if necessary.
- To remove a function that is accidentally assigned, touch [No Entry].
- Functions already assigned are grayed-out and are not available.
- Some functions display only when optional devices are installed.

5 Touch [OK].

Returns to DirectAccess Entry screen or Selections Entry screen. The selected functions are added. To add more functions, or to replace a button with another function, repeat steps 2 to 5.

6 Touch [OK].

Returns to the Admin. screen. "Direct Access" area or "Selections" screen is updated.

7 Touch [Return].

Returns to the Master Making Basic Screen or Print Basic Screen.

Advanced Features

Registering a Custom Paper Size

[Custom Paper Entry]

Non-standard paper sizes must be pre-entered into memory. Once a paper size is stored into memory, it can be retrieved with the **[Paper]** button.

Up to 30 different sizes may be entered. Previously stored sizes can be modified or deleted.

Important!:

- Custom paper sizes must be entered. Failure to do so may result in incorrect scanning.

Entering sizes and changing names

- 1 Touch **[Admin.]** on the Basic Screen for each mode.

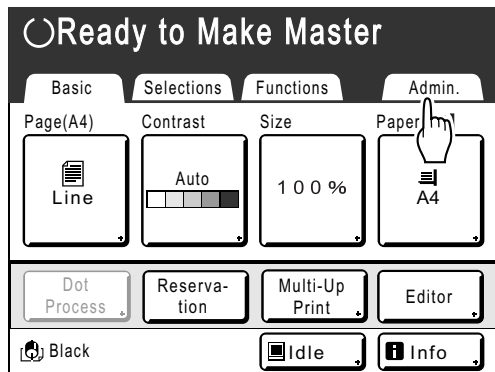

- 2 Touch **[OK]**.

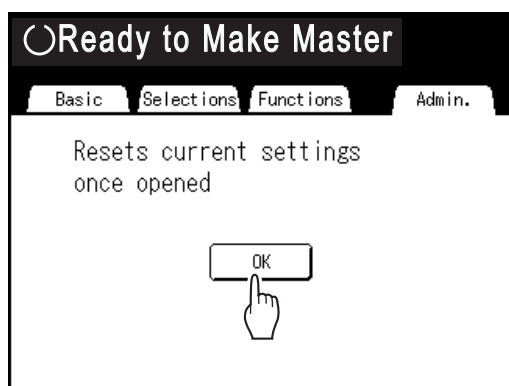

If the Recognition Screen is displayed, follow the message on the screen. See step 2 in "Customizing the Default Settings". (p.165)

- 3 Touch **[System]** or **[▶]** to display **[Custom Paper Entry]** on the screen.

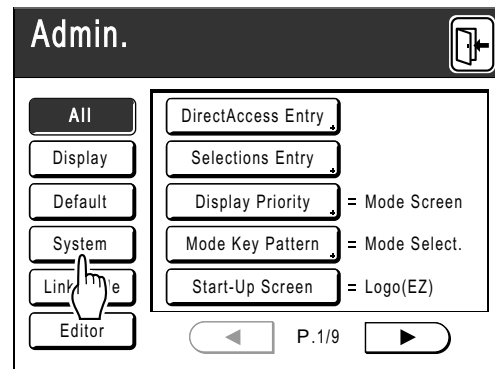

- 4 Touch **[Custom Paper Entry]**.

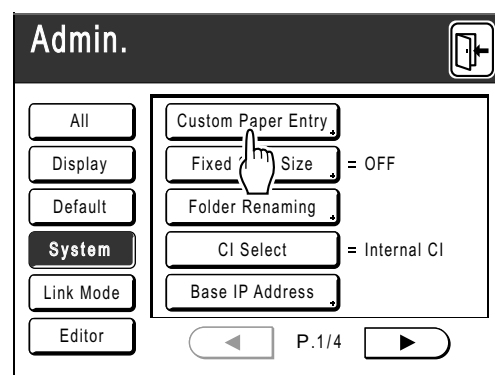

5 Touch an unused button.

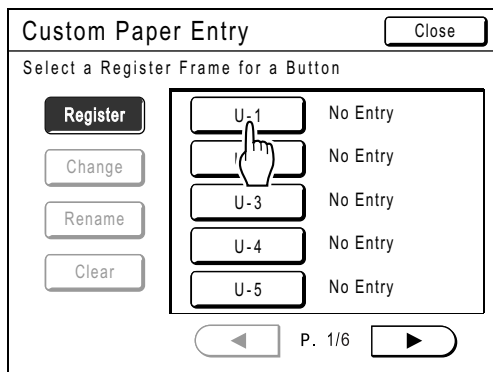

Unused buttons are displayed with a solid line. Used buttons are grayed-out and are not available.

6 Enter the paper size.

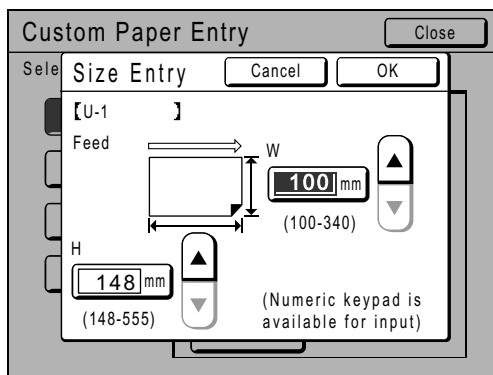

Facing towards the paper feeding direction (into Paper Feed Tray), enter W (width) and H (height). Touch either , or use Print Quantity Keys.

7 Touch [OK].

Rename as necessary.
Touch [Close] to skip renaming the size.

8 Touch [Rename].

9 Select a button to rename.

10 Touch the character buttons to enter a new name.

Change capitalization by selecting the [Small] or [Capital] button.

p.130

Note:

- To clear the current name, touch button or press the key.

11 Touch [OK] when done.

Note:

- To change a name, repeat from step 8.

12 Confirm the name and touch [Close].

Returns to the Admin. screen. Paper size is updated.

Tip:

Printing on Extended Paper

The machine can print on paper 436 mm-555 mm ($17\frac{5}{32}$ "- $21\frac{27}{32}$ ") long by storing the size as a custom-size.

p.170

When entering a size longer than 436 mm ($17\frac{5}{32}$ ") on the Custom Paper Entry screen, the paper will be treated as "Extended Paper".

When "Extended Paper" is selected on the Paper Size screen, the machine switches into "Extended Paper" mode.

Important!:

- Some Extended Paper may fail to pass through the machine due to its paper characteristics, or may get smudged with ink due to its image positioning. Consult your dealer (or authorized service representative) for advice.

"Extended Paper" Mode

- When the machine is on "Extended Paper" mode, it is indicated in the message area as either "Ready to Make Master <Ext.Paper>" or "Ready to Print <Ext.Paper>".
- On "Extended Paper" mode, the machine can print papers measuring 436 mm-555 mm ($17\frac{5}{32}$ "- $21\frac{27}{32}$ ") lengthwise from top to bottom facing the paper feed direction. However, maximum printing area and top/bottom Print Positioning range remains as usual.
 p.18
 p.94
- Print timing and speed is different on "Extended Paper" mode in comparison to normal printing. This is to be expected, so do not be alarmed.
- Contact your dealer (or authorized service representative) for suggestions about placing paper on the Paper Feed Tray and the Paper Receiving Tray when on "Extended Paper" mode.

Advanced Features

Deleting a Custom Paper Size

- 1 Touch [Custom Paper Entry] on the Admin. screen.

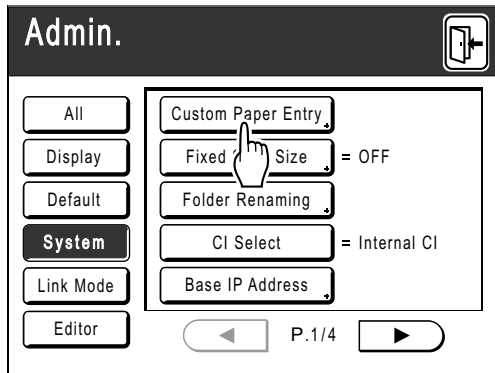

- 2 Touch [Clear].

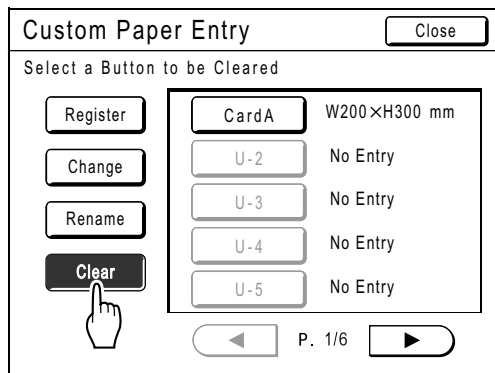

- 3 Select the paper size to clear.

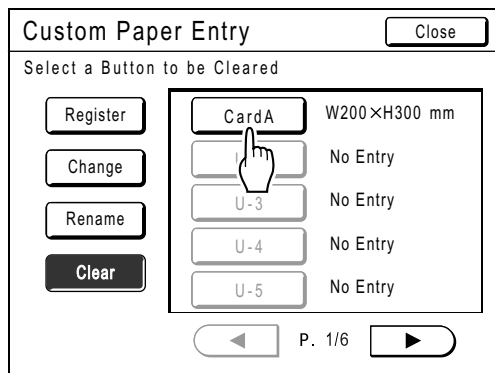

- 4 Touch [OK].

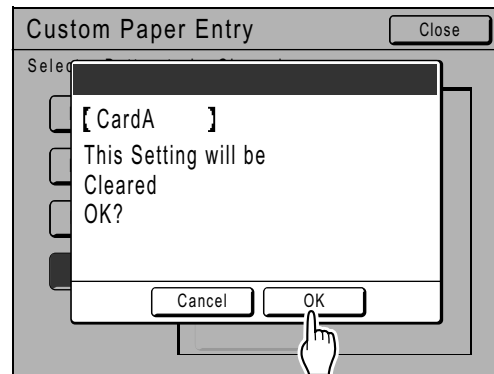

Returns to the Custom Paper Entry screen. The selected paper size is cleared.

- 5 Touch [Close].

Returns to the Admin. screen. Paper size is updated.

Keeping Masters Secure After Printing

[Protect]

After printing is completed, the master remains on the Print Drum (Cylinder). To protect confidential documents from unauthorized duplication, use the Confidential feature to discard the master after printing. (i.e. "Confidential" function) Used masters are held in the Master Disposal Box. The machine is equipped with a protection function to prevent the master from being removed from the Master Disposal Box and leaked by any ill-intended third party.

"Protect" Setting

When the "Protect" setting is ON:

- When printing is complete, the "Confidential" function is activated to show the message to discard the master remaining on the Print Drum (Cylinder).
- The Master Disposal Box is locked and cannot be removed while the machine is standby. (However, the Master Disposal Box can be unlocked and removed if the master jams in the Disposal Unit or if the Master Disposal Box becomes full.)

Locking the Master Disposal Box

To prevent any leak of master documents after printing, the Master Disposal Box can be locked with a padlock so that no-one apart from the administrator of the machine can remove it. (Purchase an ordinary padlock whose loop will fit through the hole, which is 7 mm (1/4") wide.)

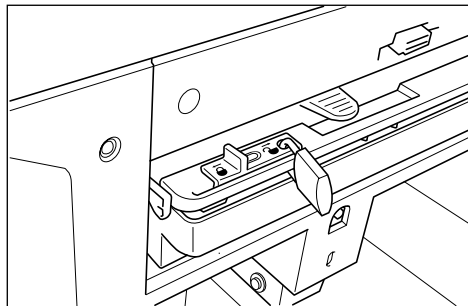

Status of Protect functions and restrictions

Status of [Protect] functions	Restrictions
Protect: OFF Padlock: No	No restrictions on printer access *1
Protect: ON Padlock: No	"Confidential" message is displayed Master Disposal Box is locked *2
Protect: OFF Padlock: Locked	No "Confidential" message is displayed Nobody but the administrator can dispose of the master.
Protect: ON Padlock: Locked	"Confidential" message is displayed Nobody but the administrator can dispose of the master.

*1 The ordinary "Confidential" function is available.

*2 The lock is released if a master jams in the Disposal Unit or if the Master Disposal Box becomes full.

Advanced Features

Preventing Leaks of Masters After Creation or Disposal [Protect]

Turning the Protect Setting ON

- 1 Touch [Admin.] on the Basic Screen for each mode.

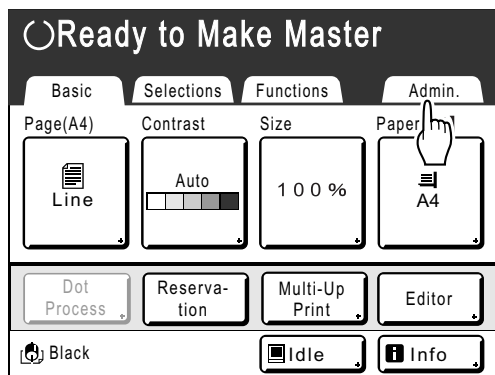

- 2 Touch [OK].



If the Recognition Screen is displayed, follow the message on the screen. See step 2 in "Customizing the Default Settings". (p.165)

- 3 Touch [Protect].

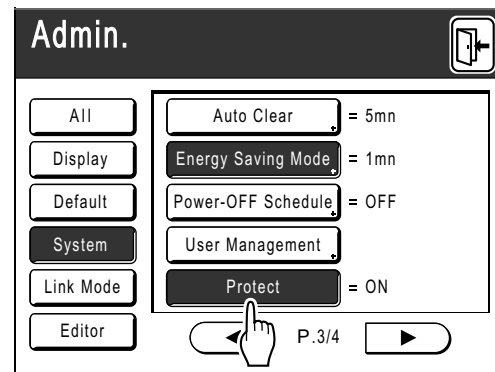

"Protect" is turned ON.

Note:

- If "Protect" is ON, "Energy Saving Mode" (Auto Sleep) is activated automatically.
- If "Protect" is ON, [Renew Page] is grayed-out and is not available.

◆ If “Protect” is ON:

The following screen is displayed after printing.

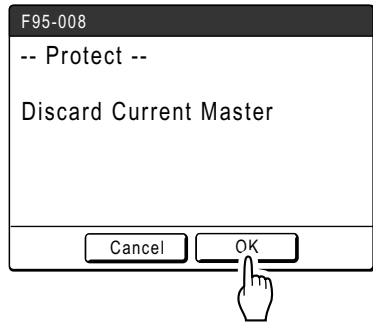

Touch **[OK]** or **[Cancel]**.

[OK]: Discards the master remaining on the Print Drum (Cylinder).

[Cancel]: Choose this when you do not wish to discard the master or wish to print further copies.

Note:

- The “-- Protect -- Discard Current Master” message is also displayed when printing from computer data on a PC.
- If you select **[Cancel]** while the “Protect” setting is active, the “-- Protect -- Discard Current Master” message appears each time you press the key or the key.
- The screen shows the message below when:
 - setting the Print Drum (Cylinder) that has been removed without the “Confidential” operation, or
 - the machine goes into the sleep mode after a certain period of time has passed after the confirmation message was displayed, and then the sleep mode is canceled (or the power is turned ON).

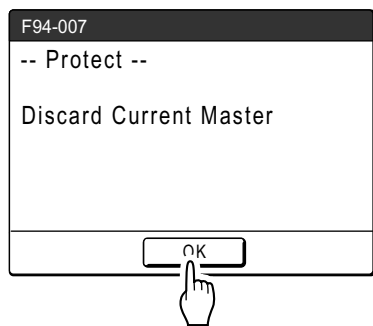

Touch **[OK]** to discard the master remaining on the Print Drum (Cylinder).

Cancel the “Protect” setting

Only the administrator can cancel the “Protect” setting.

1 Touch [Admin.] on the Basic Screen for each mode.

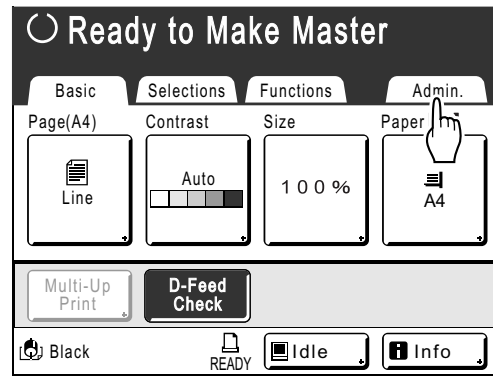

2 Touch [OK].



If the Recognition Screen is displayed, follow the message on the screen. See step 2 in “Customizing the Default Settings”. (p.165)

3 Touch [Protect].

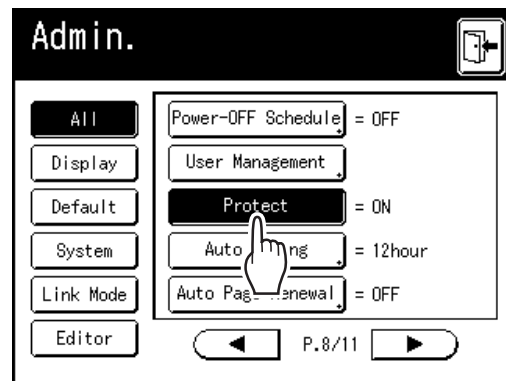

After “Please Wait a Moment” is displayed, the “Protect” setting is canceled.

Storing Original Data and Use Method

The machine can store original data. (To use this function, an optional Document Storage Card or USB Flash Drive is required.)

Stored original data can be repeatedly retrieved for printing.

There are two methods of storing original data: "Storage Memory" and "USB Flash Drive". "Storage Memory" allows you to store original data on the internal optional Document Storage Card of the printing machine. "USB Flash Drive" allows you to store original data in a USB Flash Drive. Both methods can store original data as follows.

- Storing data from a hard-copy original after scanning from the scanner of the printer.
- Storing original data created on a computer.

The methods of storing data from a hard-copy original and printing the stored original data are explained here. Details on how to store the data created on a computer, see the "RISO Printer Driver User's Guide (CD-ROM)".

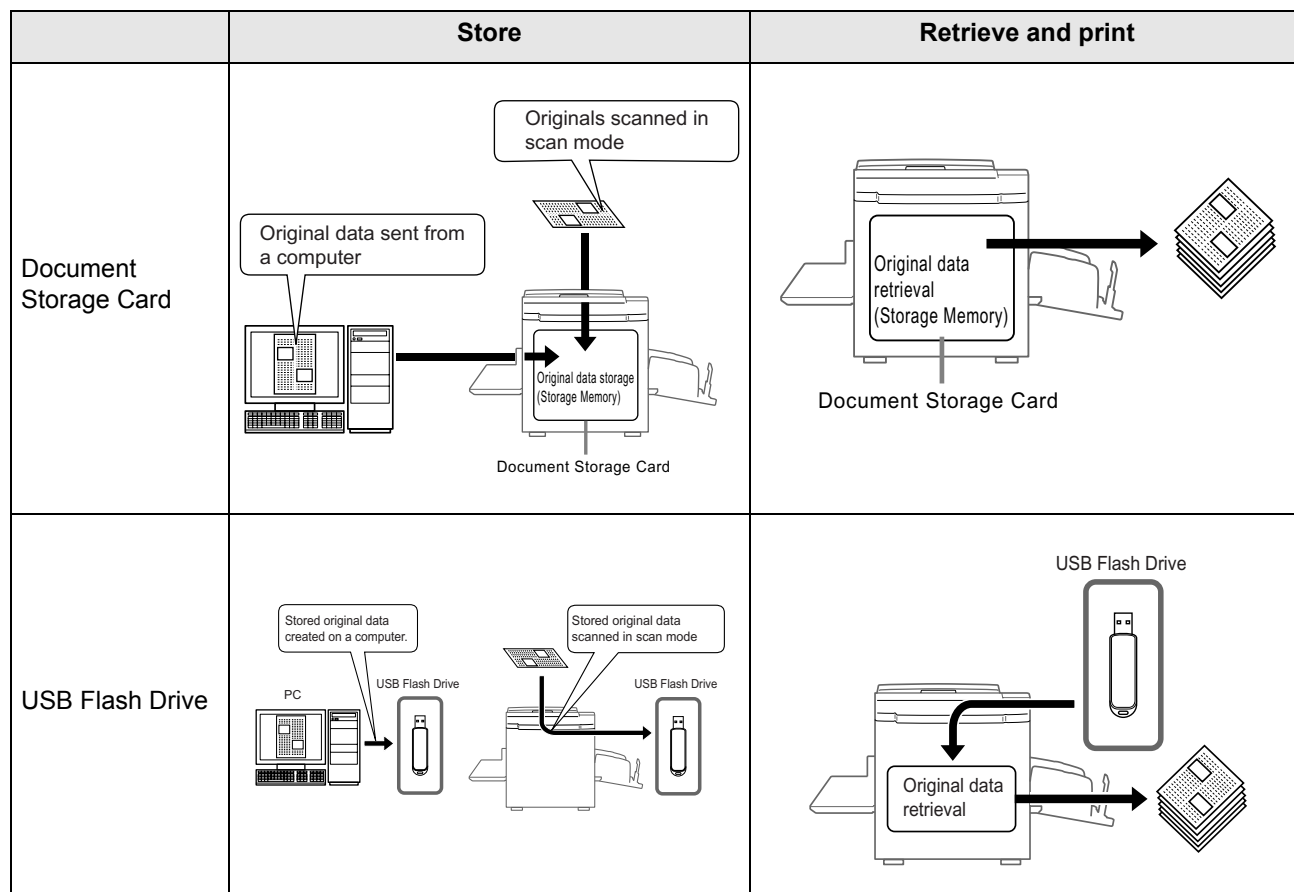

Storing Original Data and Use Method

- The following operations are available with data stored in “Storage Memory” or “USB Flash Drive”.
 - Stored original data can be repeatedly retrieved for printing.
 - If the storage data contains multiple pages, you can choose to output only odd or even pages, or indicate the specific pages to print using “Output”.
☞ p.186
 - The storage data also can be overlaid onto a hard-copy original and printed.
☞ p.187
- All users of this machine can use the 6 folders in “Storage Memory”. It is convenient to store and use the data in common with others.
- 6 folders are created in each “USB Flash Drive”. Use the folders as needed, such as when selecting a folder for storing any specified data.

Important!:

- We cannot guarantee storage data or USB Flash Drive data against loss caused by accidents or unforeseen events. We recommend that you use your computer to make back-up copies of any important documents.

Note:

- You can easily delete unnecessary stored data when remaining free area of the optional Document Storage Card or USB Flash Drive is limited. The free area is displayed in the Storage Selection screen or USB Job List screen.
☞ p.186
- As to the folder for storing original data, 6 folders are prepared for the optional Document Storage Card and 6 folders are prepared for each memory in the case of USB Flash Drives. When you use folders to share data, you are recommended to devise folder rules (e.g. dividing the folders by department or type of data)
- Folder names of the optional Document Storage Card can be changed on the Admin. screen.
☞ p.160
- To change folder names of the USB Flash Drives, use the “RISO Utility Software” (RISO USB PRINT MANAGER) included on the provided software CD-ROM. (If you change folder names by Explorer, they will not be recognized by the machine.) ☞ “RISO Utility Software User's Guide” (CD-ROM)
- You can change the order of the storage data and USB Flash Drive data.
☞ p.185

Storing Original Data and Use Method

Converting Hard-copies into Stored Data (Scan Mode)

Scan mode is a function that allows you to scan a hard-copy original with the machine's scanner to save as storage data or USB Flash Drive data.

You can repeatedly retrieve and print previously scanned and stored original data. This saves you the trouble of rescanning documents when repeatedly printing the same materials.

☞ p.183

This function also prevents documents from getting lost or damaged over time.

Important!:

- The storage function is not available in the machine equipped with the optional RISO IS300 controller. The data scanned in the Scan Mode is stored in the IS300.

Note:

- Delete unnecessary stored data when remaining free area of the optional Document Storage Card or USB Flash Drive is limited.

☞ p.186

The following functions can be used in scan mode: See the explanation of each function for more details.

- Image (☞ p.56)
- Contrast (☞ p.58)
- Size (enlargement/reduction) (☞ p.59)
- Dot Process (☞ p.65)
- Contrast Adj (☞ p.66)
- Tone Curve (☞ p.67)
- My Direct Access (☞ p.155)
- 2 Up/Multi-Up Print (☞ p.69)
- Book Shadow (☞ p.81)
- Preview (☞ p.87)

The following functions are specific to scan mode.

- Format (☞ p.182)

Scanning an Original

1 Place the original.

See step 4 in "Printing from a Paper Document or Book" (☞ p.40).

2 Select a scan mode.

See ☞ p.24 for information about selecting a scan mode.

After selecting the Scan mode and if the following "Page Size" screen is displayed, select the page size (original size) and touch **[OK]**.

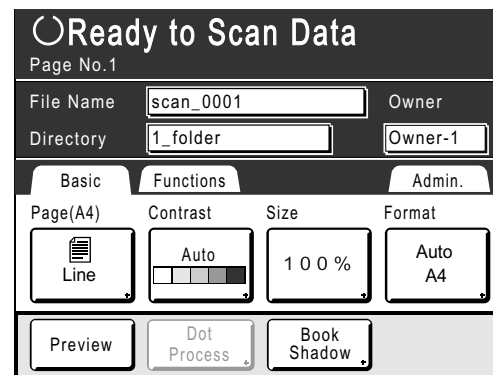
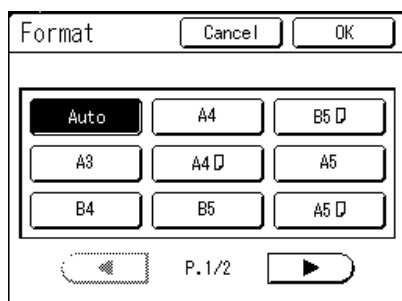

3 Setting data information.

Sets the file name, directory and owner name. ☞ p.180

4 Setting required functions.

Set the required functions for scanning the original.

Note:

- You can check scanned data instantly by enabling the "Preview" function. You can also use this function to check data before saving.
☞ p.87
- See ☞ p.178 for the functions that can be set.

Important!:

- Set "Format" when scanning custom-sized originals.
☞ p.182

5 Press the key.

The scan starts.

Note:

- After scanning the original, a preview shows on the display if "Preview" is set.

6 Repeat steps 1, 4 and 5 if the original has multiple pages.

Note:

- If multiple originals were placed on the ADF unit (Option), all originals will be scanned at the same settings.

7 Touch .

Once the original to be saved as one set of data is scanned, touch .
A confirmation screen appears.

8 Touch [Yes].

The data is saved.

Note:

- Press the  key to exit scan mode.

Storing Original Data and Use Method

Setting Data Information

Settings for the data to be scanned and stored are configured on the Scan Basic Screen. The file name, directory and owner name are automatically allocated when scan mode is started, but you can change this preset information if needed.

Note:

- Default settings for the “Directory” folder can be changed in “Admin.”. (p.160)

1 Enter a file name.

- 1) Touch the file name input box.

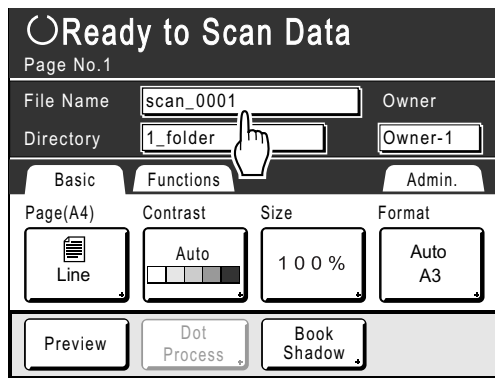

The Rename screen appears.

- 2) Touch the **[C]** button to delete the current name.

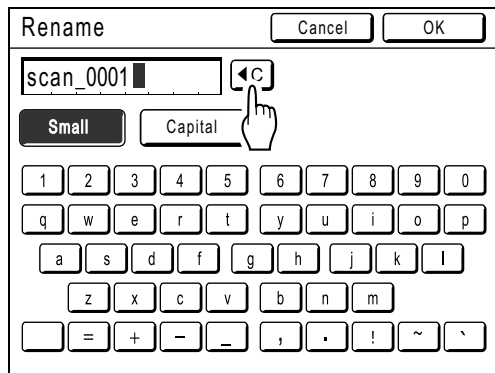

Note:

- You can also press the **[C]** key to delete.

- 3) Touch the text button and enter the file name one character at a time. Touch the Text Type button to change the display, and look for the text you want to enter. (p.130)
- 4) Touch **[OK]**. The file name is confirmed and the screen returns to the Scan Basic Screen.

2 Specifying a Directory.

When saving in the USB Flash Drive, connect the USB Flash Drive to the USB slot in advance.

Note:

- If the machine is equipped with the optional RISO Controller IS300, you cannot specify where to store the data.

- 1) Touch the directly input box.

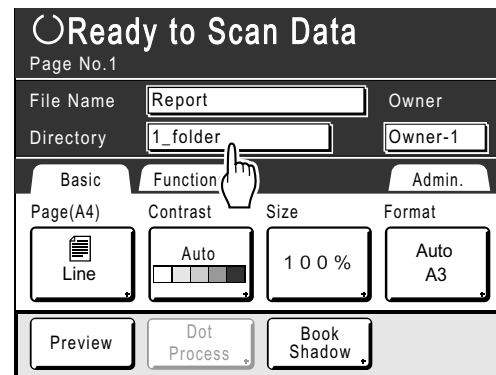

The Directory screen appears.

- 2) Touch **[Storage Memory]** or **[USB Flash Drive]**.

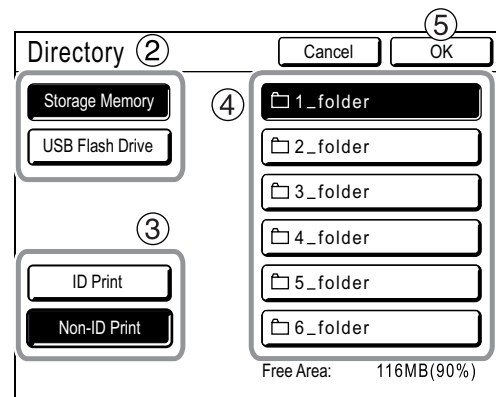

If the USB Flash Drive is not connected, **[USB Flash Drive]** is grayed-out and is not available.

- 3) Touch **[ID Print]** or **[Non-ID Print]**.
[ID Print] and **[Non-ID Print]** are displayed only when "Management Level" is set to "High/Full Management".
- 4) Touch the folder to save the data.
- 5) Touch **[OK]**.
 The "Directory" folder is confirmed and the screen returns to the Scan Basic Screen.

Note:

- The folder name of the "Directory" folder of storage data can be changed in "Admin." (p.160)

3 Specifying an Owner.

- 1) Touch the owner input box.

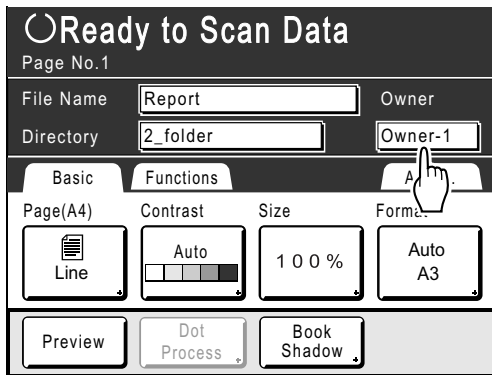

The Owner screen appears.

- 2) Touch the button of the owner to set.

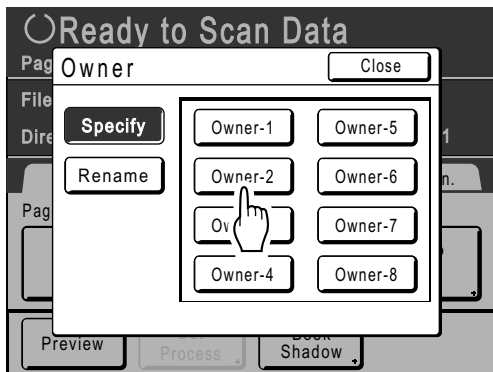

The owner name is confirmed and the screen returns to the Scan Basic Screen.

Tip:

Changing the Owner Name

- 1) Touch **[Rename]** on the Owner screen.

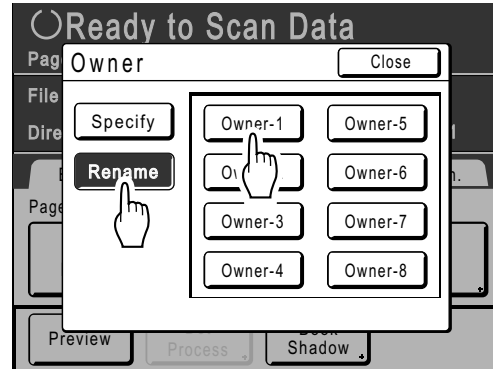

Touch the button of the owner to rename. The Rename screen appears.

- 2) Touch the **[C]** button to delete the current name.
- 3) Enter the Owner name.
- 4) Touch **[OK]**.

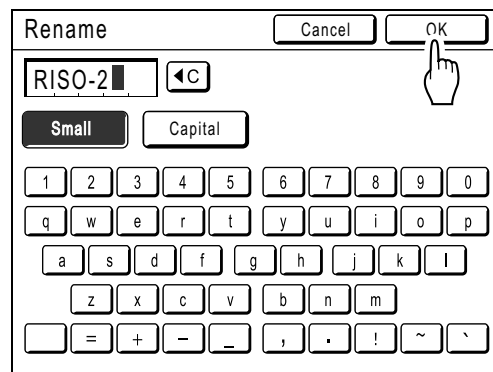

The owner name is confirmed and the screen returns to the Owner screen.

Storing Original Data and Use Method

Specifying Stored Size

Specify the size at which to save the scanned original.

It is necessary to set the Format size when:

- you place the originals on the glass platen
- you set the custom-sized originals in the ADF unit (Option)
- you want to save at a size that differs from the size of the original

When the standard-sized original is set in the optional ADF unit, the original size is detected automatically. The original is saved by original format.

1 Touch [Format] on the Scan Basic Screen.

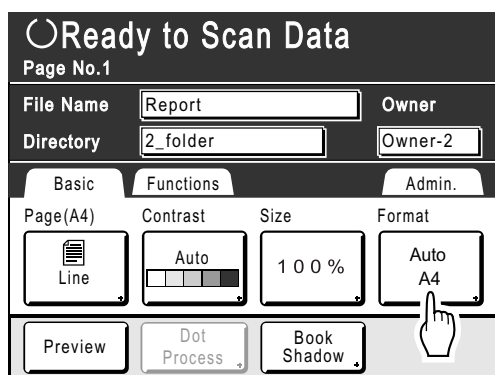

The Format screen appears.

2 Touch the Format size button to be set.

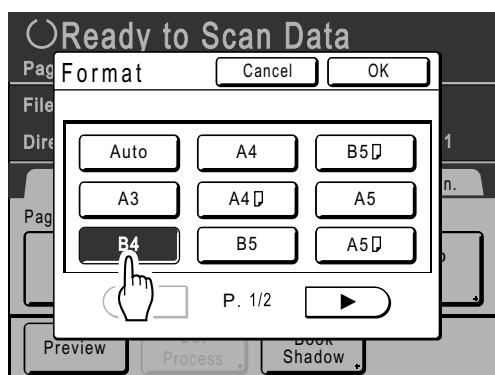

If you select [Auto], the same size as the original will automatically be set.

3 Touch [OK].

The stored size is confirmed and the screen returns to the Scan Basic Screen.

Retrieving Stored Data and Printing

[Storage Memory][USB Job List]

Retrieving and printing stored data.

Retrieving Stored Data

When retrieving the USB Flash Drive data, connect the USB Flash Drive to the USB slot in advance. For details on how to print USB Flash Drive data, see p.44 "Printing from a Computer Data".

Note:

- When "User Management" is set up by the administrator, the users will be asked to identify themselves during operations. For details, refer to p.43.
- When "Recognized by" is set to "PIN code" in User Management and the USB Flash Drive is connected while the Basic Screen for each mode is displayed, the USB Job List screen is automatically displayed. See step 2.

1 Touch [Functions] on the Master Making Basic Screen.

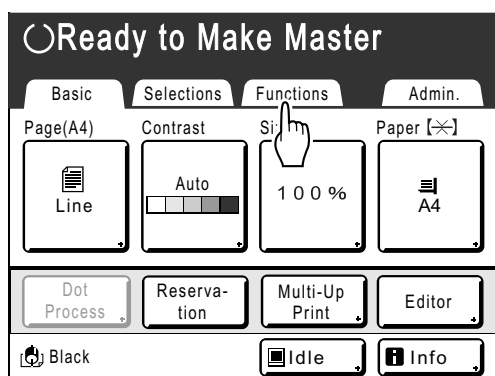

2 Touch [Storage Memory] or [USB Job List].

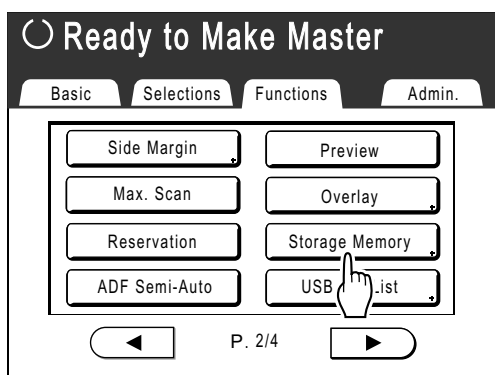

The Storage Selection screen or USB Job List screen (with "Non-ID Print") is displayed. (The "ID Print Job" button is displayed on the screen.)

3 Select [ID Print Job] or [Non-ID Print].

Note:

- When "Management Level" is set to "Low/ Admin tab only" in User Management, [ID Print Job] will not be displayed.

◆ When retrieving data set with "ID Print Job"

Touch [ID Print Job].

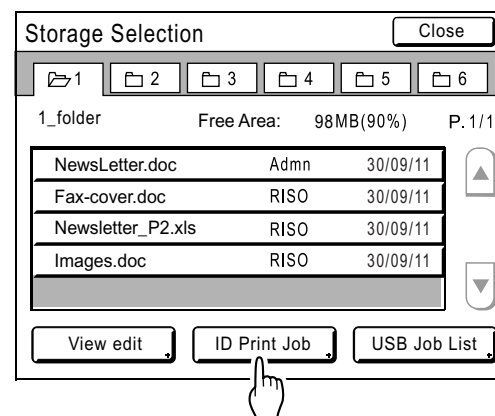

Storing Original Data and Use Method

◆ When retrieving data set with “Non-ID Print”

When “Non-ID Print” is displayed on the screen, touch “Non-ID Print”.

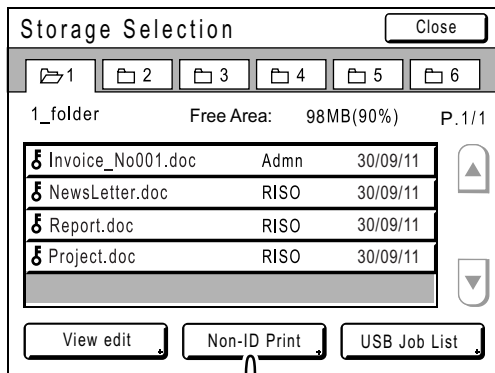

4 Touch the data to print.

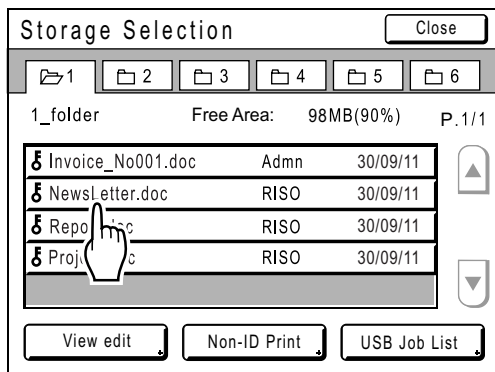

If you are selecting data stored in a different folder, touch that folder's tab.

Note:

- If the stored data is not shown on the screen, touch ▲ or ▼ to display.
- Touching [USB Job List] or [Storage Memory] displayed in the bottom right corner of the screen switches to the Storage Selection screen or USB Job List screen.
- For the data set with [ID Print], the following icon appears.
 ID Print Job

5 Confirm the retrieved data.

Use the thumbnail to determine whether the retrieved data is the data desired.

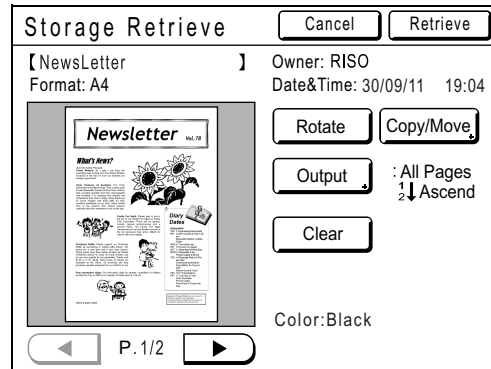

From the Storage (USB Job List) Retrieve screen, you can confirm retrieved data and specify output settings.

See p.186 for operational details.

6 Touch [Retrieve].

The data is retrieved and Storage Mode Basic Screen appears.

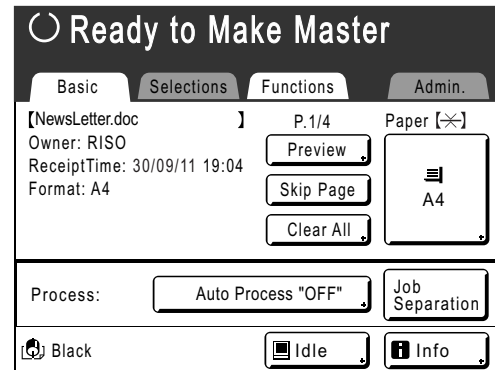

7 Press the  key.

A master is made from the data.

After this, follow the same operations for paper documents.

Changing the Data Order

You can change the order of the stored data displayed on the Storage Selection screen/USB Job List screen.

Note:

- The factory setting is "Date Descend".

1 Touch [View edit].

Note:

- [View edit] is inactive if there is no storage data/USB Flash Drive data or only one stored item.

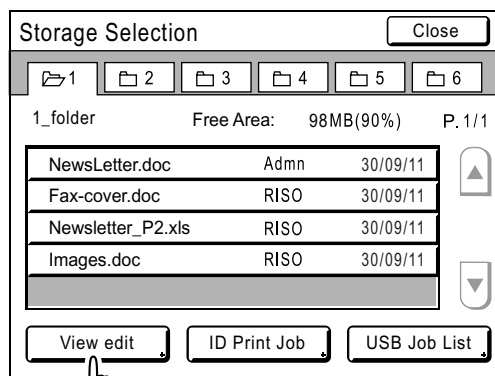

3 Touch [OK].

Returns to the Storage Selection screen (USB Job List screen).

2 On the Sorting screen, touch the button of the order you want.

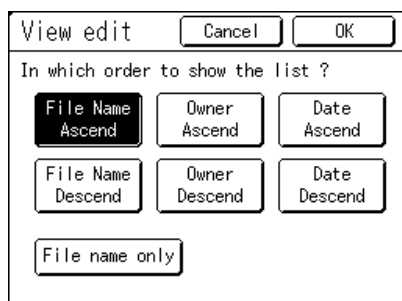

Note:

- By using ON (inverted)/OFF of [File name only], the data display format can be switched on the Storage (USB) Selection screen.

OFF: File Name + Owner Name + Date
ON (inverted): File Name

Storing Original Data and Use Method

Using the Storage Retrieve Screen/USB Job List Retrieve Screen

Each section of the Storage Retrieve screen/USB Job List Retrieve Screen is shown below. An example of the Storage Retrieve screen is explained here.

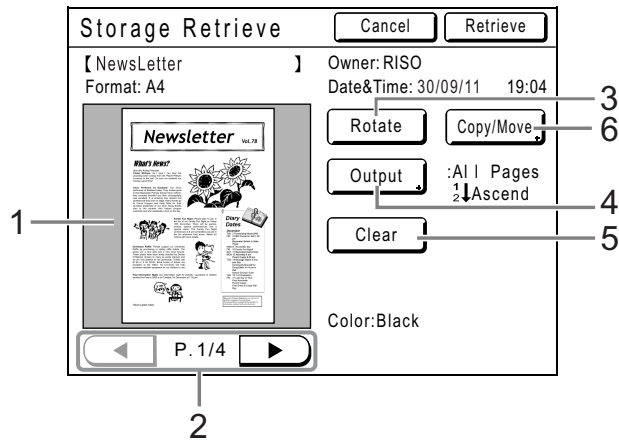

- 1) A thumbnail is displayed for each page.
- 2) If the data contains multiple pages, touch to change page.
- 3) Touch to rotate the storage data 180 degrees and output.
- 4) **Output Range**
If the storage data/USB Flash Drive data consists of multiple pages, you can specify which pages to print. Touch **[Output]** to display the Output screen.

- 5) **Clear**
Touch **[Clear]** and a confirmation screen appears. Touch **[OK]** to clear the data.

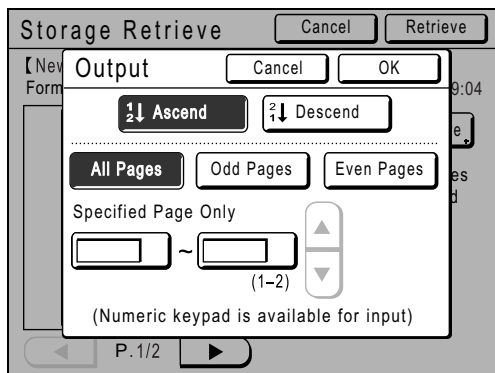
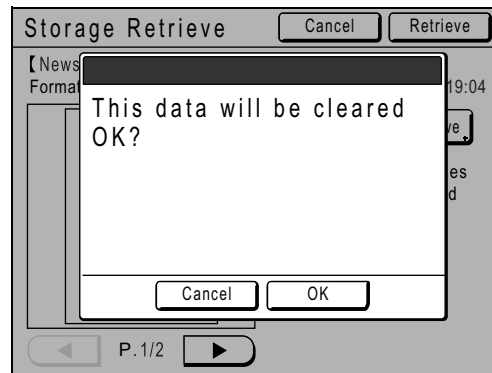

Touch the corresponding buttons to print all pages, only odd pages, or only even pages. You can also specify whether to print the selected pages in **[Ascend]** or **[Descend]** order.

To specify a page range, touch the page input box and touch either or to specify the pages.

- 6) **Copy/Move**
Copy/Move the stored data between the Storage Memory and USB Flash Drive. From the Storage Retrieve screen, copy/move data to the USB Flash Drive. From the USB Job List retrieve screen, copy/move data to the Storage Memory.
For details, see [p.189](#).

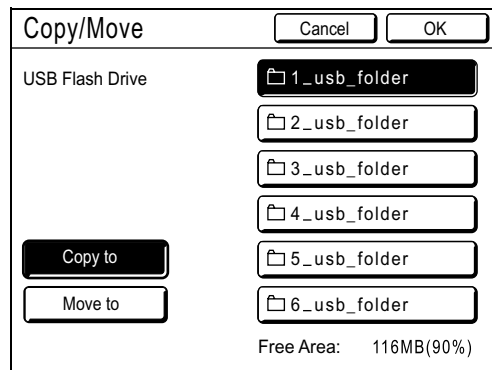

Overlaying Stored Data onto a Print Job [Overlay]

You can overlay stored data onto a hard-copy original.

For example, this function can be used to overlay a stamp over multiple originals indicating "Sample".

Important!:

- To use this function, the optional Document Storage Card or USB Flash Drive is required.
- This function cannot be used with the following functions.
 - Ink Saving
 - Top Margin
 - Side Margin
 - Storage Memory ("Overlay" images cannot be stored.)
 - USB Job List ("Overlay" images cannot be stored.)
 - When sending original data from the computer

1 Place an original.

Place the original on Glass Platen or in ADF unit (Option).
See p.37 for information on placing the original.

2 Touch [Functions] on the Master Making Basic Screen.

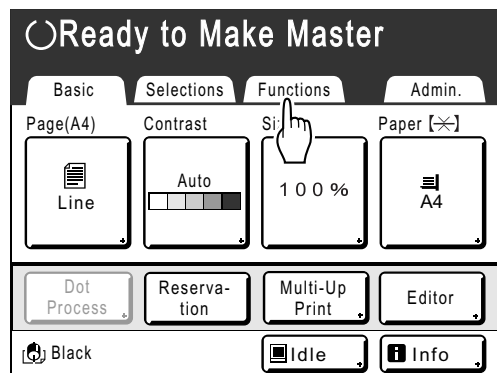

3 Touch [Overlay].

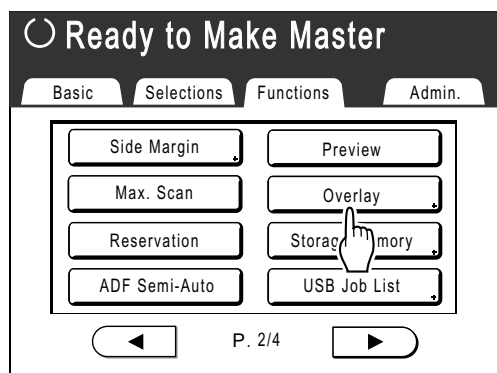

The Storage Selection screen appears.

When overlaying data stored in the USB Flash Drive, connect the USB Flash Drive to the USB slot and touch **[USB Job List]**.

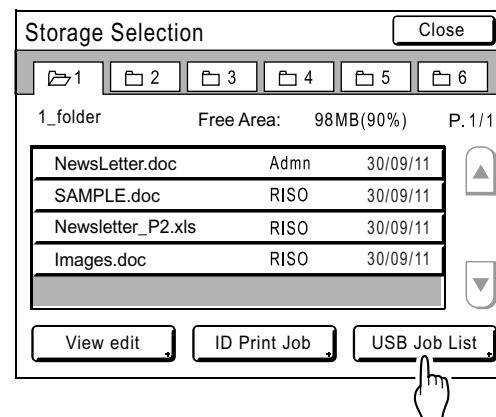

USB Job List screen is displayed.

Important!:

- Do not remove the USB Flash Drive until printing is finished.

4 Select the stored data to overlay.

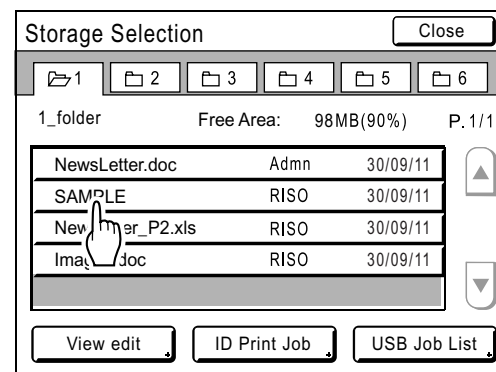

Storing Original Data and Use Method

Details on how to select data, see steps 4 and 5 in "Retrieving Stored Data and Printing" (p.183).

5 Check the stored data.

Check the thumbnail to make sure that the data is the data you want to retrieve.
When there are several pages (editions), display the data by touching ◀ or ▶ button.

Important!:

- Only one page of data can be retrieved for Overlay.

6 Touch [Retrieve].

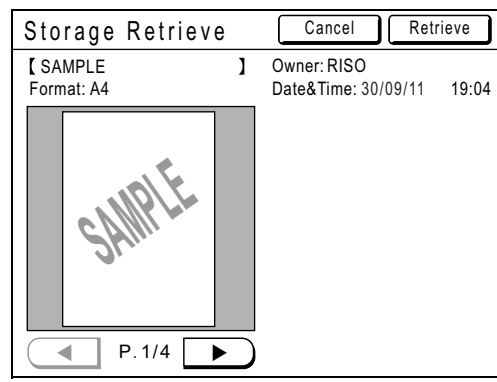

"Overlay" is set and the screen returns to the Functions screen.

7 Make necessary operation to print.

For subsequent operations, see step 5 in "Printing from a Paper Document or Book" (p.40).

Tip: Overlaying Stored Data

The stored data overlays at the size it was saved. You cannot enlarge/reduce the size to match the original or paper size.

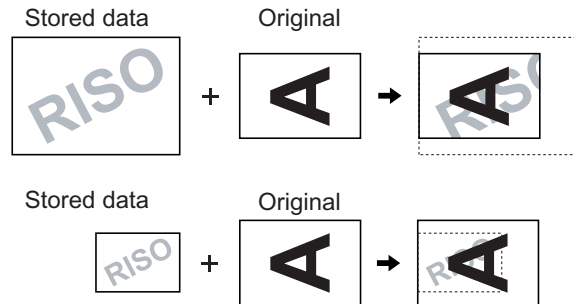

The stored data is overlaid after being centered at the top of the original. You cannot adjust the overlay position.

Copying/Moving Stored Data

Data can be copied or moved between the Storage Memory and USB Flash Drive. This is useful for performing backup or when the remaining free area of the Storage Memory or USB Flash Drive is limited.

Note:

- It is not possible to copy/move data within the Storage Memory or USB Flash Drive.
- The original data stored in the USB Flash Drive can be organized or managed by a computer using the “RISO Utility Software” (RISO USB PRINT MANAGER) included on the provided CD-ROM. For details, see the “RISO Utility Software User’s Guide” (CD-ROM).
- The [ID Print Job] is maintained even if it is copied or moved.

The procedure for copying/moving data from the Storage Memory to the USB Flash Drive is explained here.

1 Confirm that the USB Flash Drive that will store the data is connected.

If the USB Flash Drive is not connected, connect the USB Flash Drive to the USB slot.

2 Touch [Functions] on the Master-Making Basic Screen.

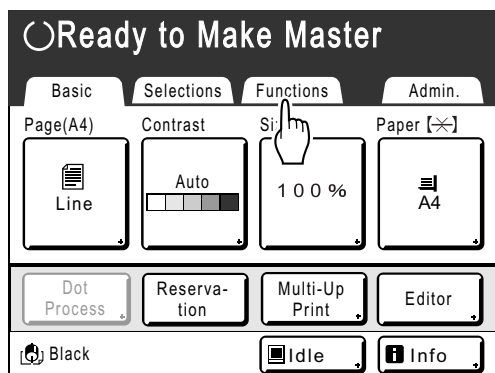

3 Touch [Storage Memory].

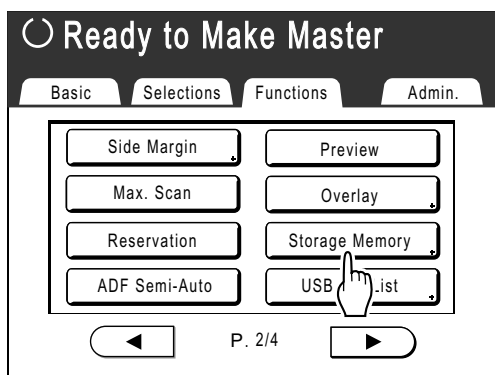

Note:

- When copying/moving the data from the USB Flash Drive to the Storage Memory, touch [USB Job List].

4 Touch the storage data to copy/move.

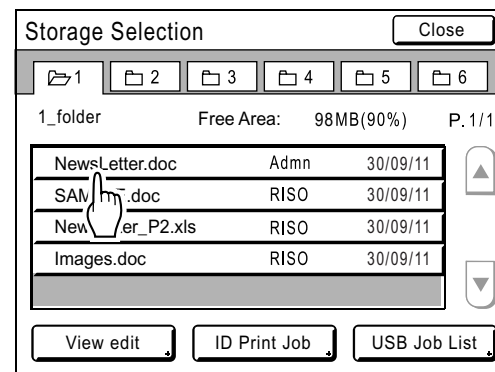

For details on how to select data, see steps 3 and 4 in “Retrieving Stored Data and Printing” p.183.

5 Touch [Copy/Move].

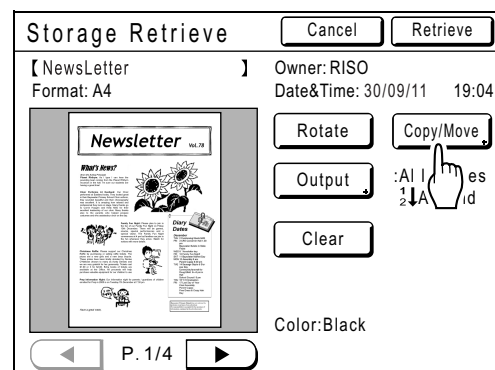

Storing Original Data and Use Method

6 Touch [Copy to] or [Move to].

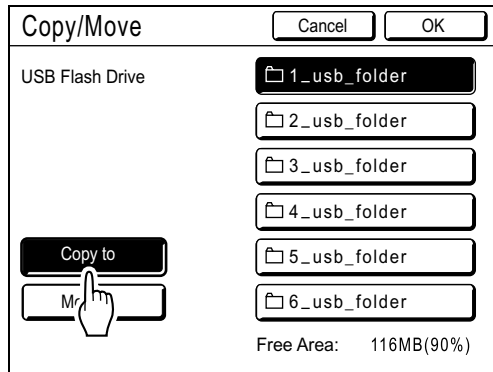

7 Touch the button of the destination folder that you want to copy or move the data to.

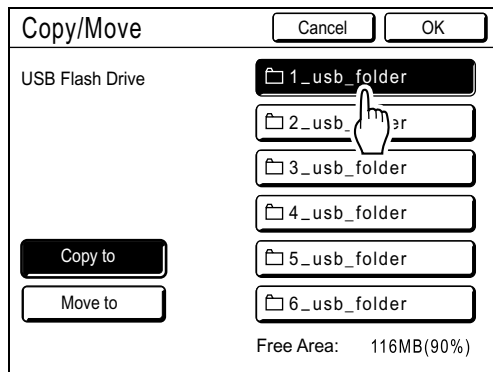

8 Touch [OK].

Data is copied/moved and the selected destination folder is displayed.

Important!:

- While processing the data, do not remove the USB Flash Drive. This will cause data to disappear and the USB to malfunction.

Note:

- When the remaining free area of the USB Flash Drive is limited, the following message is displayed. Touch **[USB Job List]** to organize the data of USB Flash Drive, or touch **[Cancel]** to cancel copying/moving.

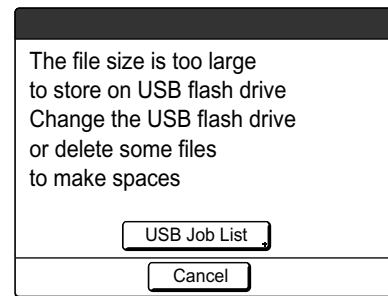

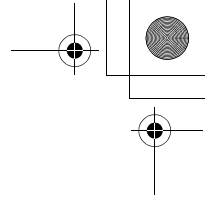

Storing Original Data and Use Method

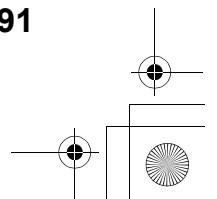
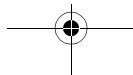
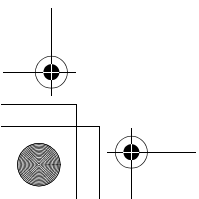
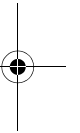
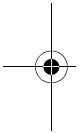

When using a Linked Printer

Print Functions for Using Linked Printers

The machine may be connected with Linked Printers for more convenient operations.
2 special printing functions Auto-Link Function and Link Mode are available;

Important!:

- The RISO Network Card is required in order to connect the machine and Linked Printers.
- Please contact your dealer (or authorized service representative) for the compatible printer.

Auto-Link Function

(This function is not available for EZ591U.)

Automatically select an output device, the machine or a Linked Printer, based on a pre-determined number of copies (Link-Free Volume).

☞ p.164

Even when you print by retrieving the original data stored in a USB Flash Drive or the optional Document Storage Card, you can print the data by automatic allocation depending on the quantity.

☞ p.164

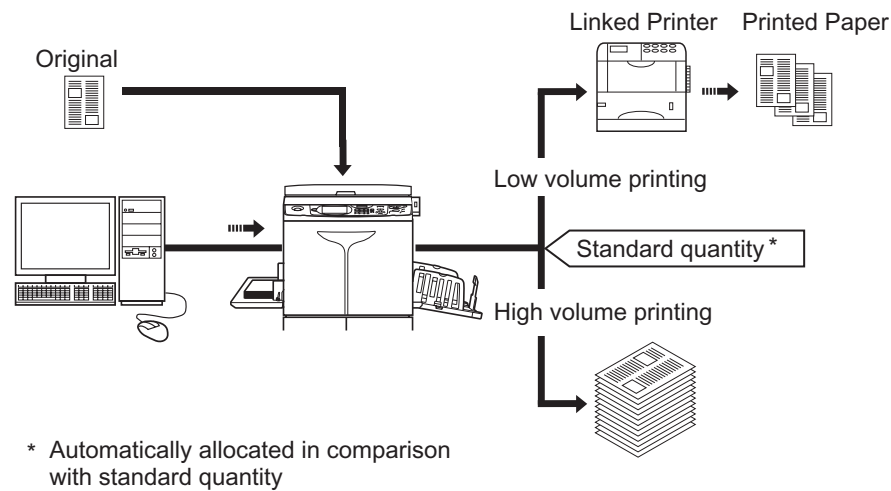

Important!:

- In the case of hard-copy originals, you need to enter print quantity before master-making. If you press the  key when the quantity is "0", the machine prints the data unconditionally.

Link Mode Function

The original is scanned on the machine and printed from the Linked Printer.

☞ p.197

Special Linked Printer functions such as double-sided printing can be achieved.

Setting up a Linked Printer [Link Properties]

Linked Printer data must be entered in the machine in order to operate.

“Link Properties” are explained below.

See “Link Mode” (p.164) for more information about Link Mode and other Admin. settings.

Important!:

- Make sure that the Linked Printer is physically connected to the machine. A Linked Printer cannot be recognized by the machine unless physically connected.
- Enter information for each attached Linked Printer one device at a time.
- When there’s only one Linked Printer to the machine, set “Linked Printer” as “One-to-One”.
- Unless the Linked Printer data is entered in the machine, the device will not print, and its optional features will not be available.

Setting up a Linked Printer

1 Touch [Link Mode] on the Admin. screen.

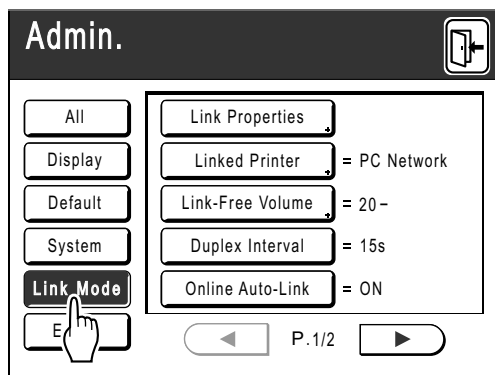

2 Touch [Link Properties].

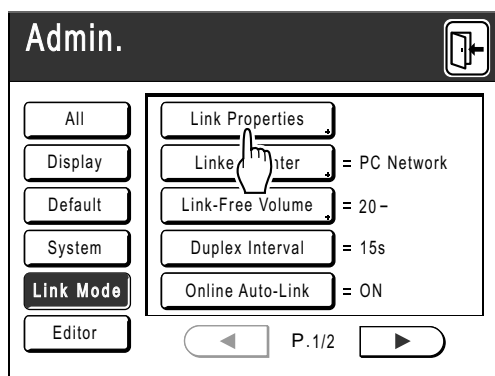

3 Select a tab for the Linked Printer.

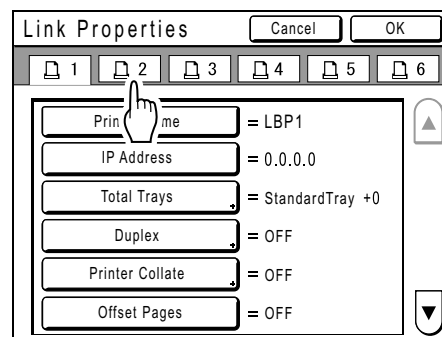



Note:

- Up to 6 Linked Printers may be entered.

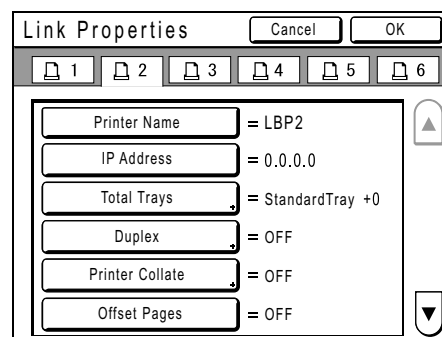
4 Select the button to enter information.



Note:

- To display other functions that are not visible on the screen, touch  or .

When using a Linked Printer

5 Change settings.

See “Linked Printer Setup List” (p.194) to change settings.

Note:





- If the function has additional Setup screens, enter necessary settings then touch **[OK]**. Returns to the Link Properties screen. The changes are updated. Touch **[Cancel]** to cancel the changes and return to the Link Properties screen.

6 Touch .



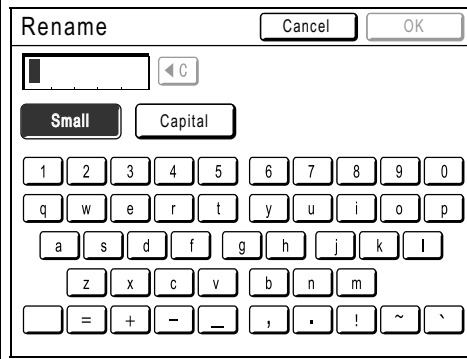
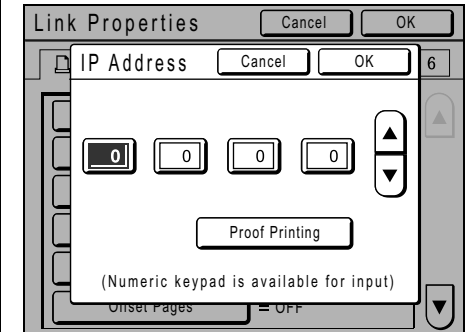



Returns to the Basic Screen. “Admin.” settings are updated.

Linked Printer Setup List

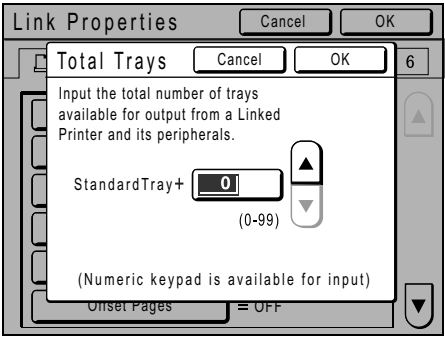

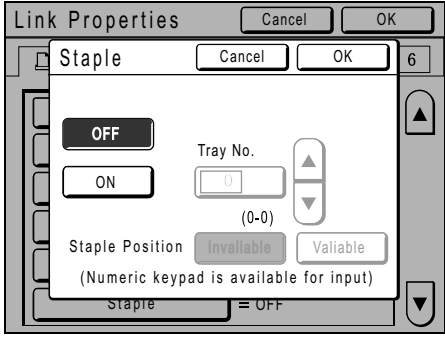
== : Initial setting (factory default)

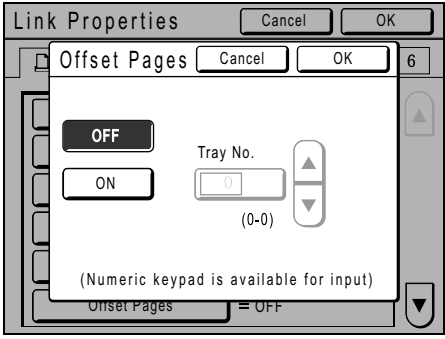
Functions	Description	How to Enter
<p>Printer Name Enter a name for the Linked Printer.</p> <p>Note:</p> <ul style="list-style-type: none"> • The entered name will be displayed on the Link Mode screen. 		 <p>Touch character button to enter a new name. Once the name is entered, touch [OK] to store it as the Printer Name. See “Rename screen” (p.130) for more details.</p>
<p>IP Address Enter the IP address of the Linked Printer to connect to the network.</p> <p>Note:</p> <ul style="list-style-type: none"> • Touch [Proof Printing] to execute a data transmission test to the Linked Printer. When successful, the test results will print from the Linked Printer. • [Proof Printing] is disabled until “Base IP Address” is correctly entered on the Admin. screen. p.161 		 <ul style="list-style-type: none"> • Use , , or enter using the Print Quantity Keys. • To move to another field, touch the field, or press the  key to move.

When using a Linked Printer

Functions	Description	How to Enter
<p>Total Trays Enter total number of trays other than the Standard Tray.</p> <p>Important!:</p> <ul style="list-style-type: none"> • If the number is less than the number of trays set in other options, other options will be disabled. • Enter the actual number of trays available for the linked printer. Entering an incorrect number will result in output from the Standard Tray. 	<p>0-99</p>	 <ul style="list-style-type: none"> • When printing from the standard tray of the Linked Printer, enter "0". • Use , , or enter using the Print Quantity Keys.
<p>Staple Set "Staple" ON if the device has the capability. Also set the tray number *1 used by the "Staple" function and whether it is fixed/variable.</p>	<p>OFF: No Staple capability (disabled) ON: Staple function available Tray number used, Invariable/variable</p>	 <p>Touch to select a button. Use , , or enter using the Print Quantity Keys for "Tray No.".</p>
<p>Offset Pages Set "Offset Pages" ON if the device has the capability. Also set the tray number *1 used by the "Offset Pages" function.</p>	<p>OFF: No Offset Pages function (disabled) ON: Offset Pages available Tray number used</p>	 <p>Touch to select a button. Use , , or enter using the Print Quantity Keys for "Tray No.". "Offset Pages" and "Punch" may be configured using similar steps.</p>

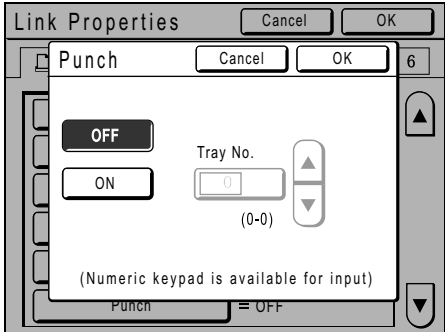
When using a Linked Printer

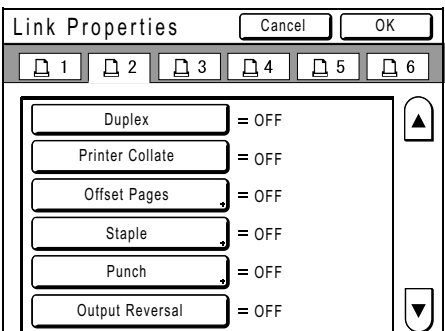
Functions	Description	How to Enter
<p>Punch Set "Punch" ON if the device has the capability. Also set the tray number *1 used by the "Punch" function.</p>	<p>OFF: No Punch capability ON: Punch function available Tray number used</p>	 <p>Touch to select a button. Use  , or enter using the Print Quantity Keys for "Tray No.". "Offset Pages" and "Punch" may be configured using similar steps.</p>
<p>Duplex Set "Duplex" ON if the device has the capability.</p>	<p>ON/OFF</p>	 <p>Touch each button to switch between OFF/ON. "Duplex", "Printer Collate", "ADF Auto Face-up" and "Mailbox" may be configured using similar steps.</p>
<p>Printer Collate Set "Printer Collate" ON if the device has the capability.</p>		
<p>ADF Auto Face-up Set "ADF Auto Face-up" ON if the device has the capability.</p>		
<p>Output Reversal*2 Set "Output Reversal" ON if the device has the capability.</p>		
<p>ADF Auto Reversal Set "ADF Auto Reversal" ON if the device has the capability.</p>		
<p>Mailbox Set "Mailbox" ON if the device has the capability.</p>		

*1 The tray number may differ depending upon the model of the Linked Printer.

*2 This function is only available only if the machine is equipped with the Auto Document Feeder AF-VI.

Printing Scanned Original from a Linked Printer



[Link Mode]

The mode in which an original is scanned into the machine and printed from a Linked Printer is called "Link Mode". In Link Mode, the original is printed from the Linked Printer, regardless of the number of copies to print.

1 Place the original.

Place the original on the Glass Platen or in the optional ADF unit.
To place the original, see p.37.

2 Switch to Link Mode.

Press the  key on the machine to switch to Link Mode.
From Mode Screen, touch **[Link Print]** to switch to the Link Basic Screen.
When "Mode Key Pattern" is set to "Loop", press the  key until the Link Basic Screen is displayed.
p.24

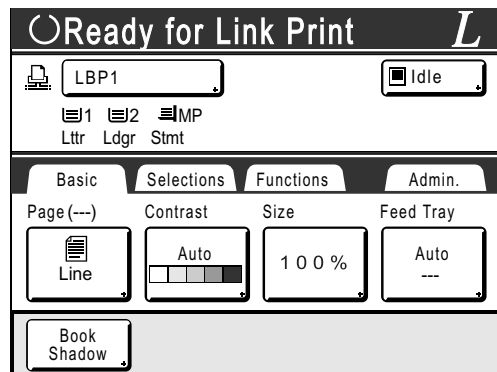

Note:

- While the message "Starting Up Network Card / Acquiring Linked Printer Configuration Data Please Wait a Moment" is displayed on the machine, the Linked Printer information is being retrieved via the network. Wait until the message disappears.

3 Select printing paper.

If the Linked Printer has multiple feed trays, touch **[Feed Tray]** to specify the tray (paper size).

- 1) Touch **[Feed Tray]** in the Link Basic Screen.

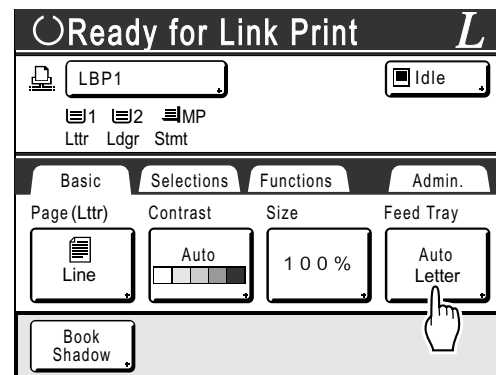

- 2) Select the desired paper size.

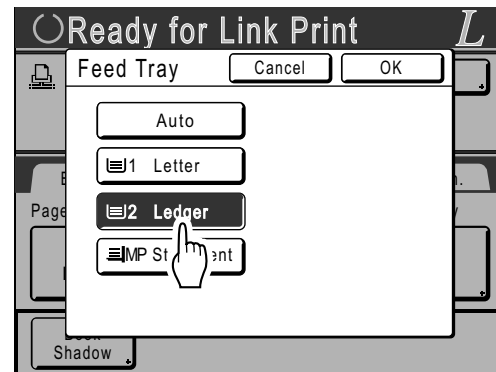

- 3) Touch **[OK]**.

When using a Linked Printer

4 Select the print functions as needed.

The following functions are available:

- Image Processing mode (p.56)
- Scanning Contrast (p.58)
- Size (p.59)
- Dot Process (p.65)
- Memory (p.134)
- Contrast Adj (p.66)
- Tone Curve (p.67)
- Book Shadow (p.81)
- Top Margin (p.83)
- Preview (p.87)
- Overlay (p.187)
- Reservation (p.142)
- Storage Memory (p.183)
- My Direct Access (p.155)

Note:

- If the Linked Printer has optional devices such as a duplex unit, the optional functions are also available.
p.199
- Print Speed, Contrast, or Positioning cannot be adjusted.
- When a computer sends an output signal to the machine while it is in operation, such interrupting data may take priority, initiating a new print job over current one.
We recommend that you set "Reservation" on the Admin. screen to set higher priority on output jobs from Linked Printers. Data received from the computer within specified time frame will not be processed.
p.142

5 Enter the number of copies using the Print Quantity Keys.

The number is displayed on the Print Quantity Display.

Note:

- To change the number, press the **C** key, then re-enter the correct number.

6 Press the **START** key.

The scan of the original begins.
The scanned original data is sent to the Linked Printer, and the specified number of copies is printed from the Linked Printer.

Note:

- The current settings can be stored in Job Memory for future retrieval of the same settings.
p.134

7 Press the **RESET** key when the print job is complete.

The setting returns to its default value.

Tip:

When multiple Linked Printers are connected to the network

When multiple Linked Printers are connected to the network, output device can be selected as needed.

- 1) Touch the "Printer Name" button in the Link Basic Screen.

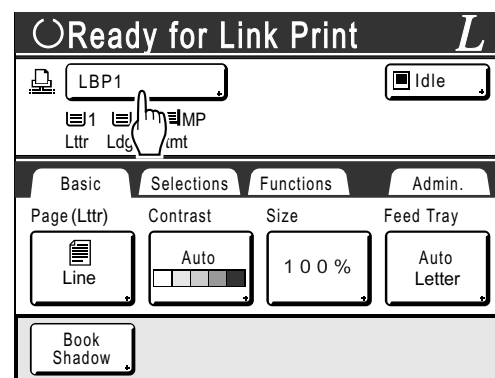

- 2) Select the Linked Printer to print from.

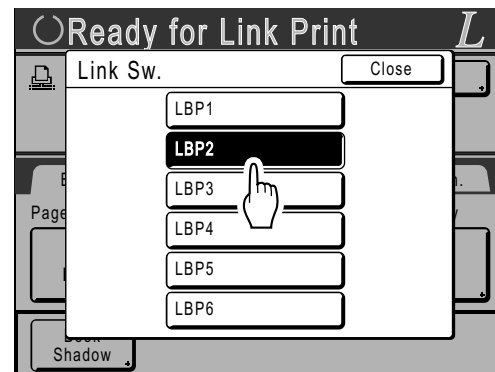

Note:

- If a Linked Printer is experiencing an error, that device is not available to be selected.
- If an error occurs on the selected Linked Printer while in Link Mode, the Link Sw. screen opens. Reselect another Linked Printer currently available for printing. For information on purchasing additional Linked Printers, contact your dealer (or authorized service representative).

Using Optional Functions on a Linked Printer

Steps for setting up optional functions are shown below. These are available when the Linked Printer has an optional device such as a sorter or a duplex unit installed.

Note:

- See Linked Printer User's Guide for further details on each function.

1 Touch [Functions] in the Link Basic Screen.

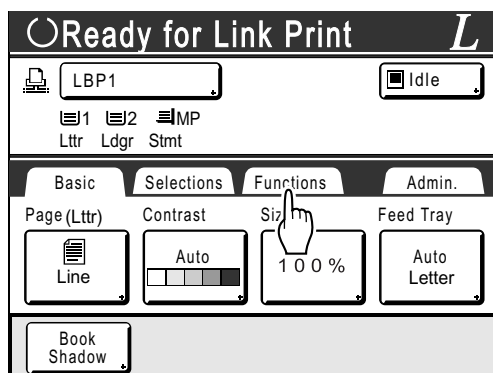

2 Select a function to modify.

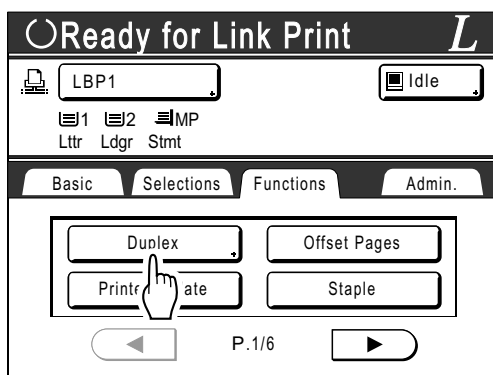



3 Make changes as needed.

See "Configurable Functions" (p.200) to select correct settings.

When using a Linked Printer

Configurable Functions

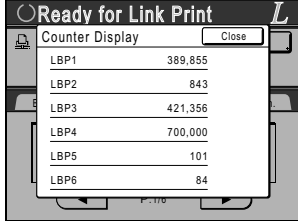
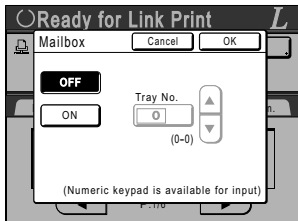
—: Initial setting (factory default)

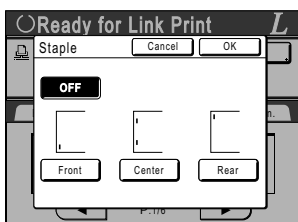
Functions	Description	Screens and Steps	Related Admin. Settings
<p>Meter Display Displays the number of printed copies for each Linked Printer recognized by the machine.</p>	---		---
<p>Mailbox Select a paper receiving tray as an Output Tray.</p>	<p>ON/OFF Tray No. 1 to n (n is the total number of trays set on "Total Trays" on the Admin. screen.)</p>	 <p>Touch   or enter using the Print Quantity Keys.</p>	<p>Total Trays: The total number of trays. Set at 1 or more.</p> <p>Note:</p> <ul style="list-style-type: none"> When the "Sort" function is set to ON, you cannot set the "Total Trays" function.
<p>Offset Pages Enable a feature to alternately eject multiple-page print copies.</p>	ON/OFF	---	<p>Offset Pages: Available only when "Offset Pages" option is ON.</p>
<p>Staple Specify the positioning of staples on printed copies.</p>	<p>Differs depending on how the "Staple Position" is set on the Admin. screen.</p> <ul style="list-style-type: none"> When set to "Invariable": ON/OFF When set to "Variable": OFF /Front/Center/Rear 	 <p>Touch to select a button.</p>	<p>Staple: Available only when "Staple" option is ON.</p> <p>Note:</p> <ul style="list-style-type: none"> When the "Sort" function or the "Offset Pages" function is set to ON, you cannot set the "Staple" function.
<p>Punch Select whether to punch holes on the printed copies.</p>	ON/OFF	---	<p>Punch: Available only when "Punch" option is ON.</p> <p>Note:</p> <ul style="list-style-type: none"> When the "Sort" function or the "Offset Pages" function is set to ON, you cannot set the "Punch" function.

When using a Linked Printer

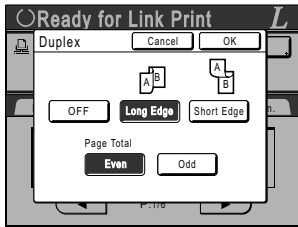
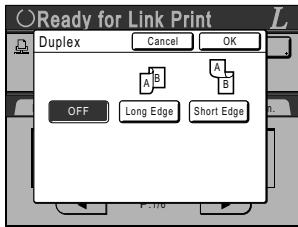
Functions	Description	Screens and Steps	Related Admin. Settings
<p>Output Reversal This enables reverse output of originals scanned with the optional ADF unit.</p>	ON/OFF	---	Output Reversal: Available only when "Output Reversal" option is ON.
<p>Printer Collate Select to retain original page order of the multi-page prints while ejecting into a single tray.</p>	ON/OFF	---	Printer Collate: Available only when "Printer Collate" option is ON.
<p>Duplex Print on both sides of the paper. Different screens and steps apply depending on whether or not the machine is equipped with the optional Auto Document Feeder AF-VI unit or Auto Document Feeder DX-1 unit.</p> <p>Note:</p> <ul style="list-style-type: none"> For instructions on how to print double-sided, See "Duplex Printing" (p.202). 	<ul style="list-style-type: none"> When the Auto Document Feeder AF-VI is installed OFF/Long Edge/Short Edge Page Total: Odd/Even When the Auto Document Feeder AF-VI is not installed OFF/Long Edge/Short Edge 	<ul style="list-style-type: none"> When the Auto Document Feeder AF-VI is installed  Touch to select a button. When the Auto Document Feeder AF-VI is not installed  	---

Important!:

- Some optional functions may not be enabled concurrently, depending on the model and option configuration of the Linked Printer.

When using a Linked Printer

Duplex Printing

[Duplex]

Double-sided printing is possible when a Duplex Unit (Option) is installed to a Linked Printer.

Note:

- The “Duplex” settings can be made from either Master Making or Print Functions screens. Linked Printer will print following the specifics set via either of these screens.

Using the Glass Platen or Auto Document Feeder AF-VI

This setting is available when a connected Linked Printer is equipped with the optional duplex printing unit.

1 Touch [Duplex] on the Functions screen.

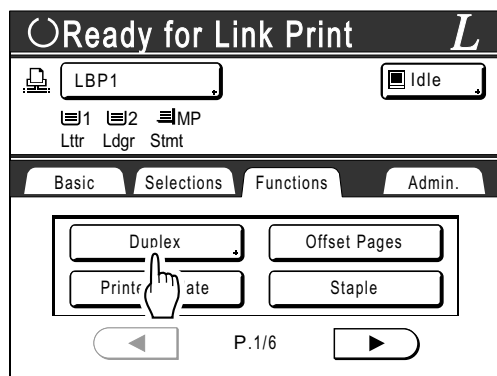

2 Set duplex binding direction.

Set the binding direction as shown below. The combination of scanning orientation and binding direction will result in different styles.

Scanning orientations and duplex binding directions.

Original Orientation	Vertical (Portrait)	Horizontal (Landscape)
Binding Direction		
Long Edge		
Short Edge		

3 Select the number of originals.

When scanning an original from the optional ADF unit, select either **[Even]** or **[Odd]** numbers to match the number of original sheets.

Important!:

- This step is not necessary unless using the ADF unit. Continue on to step 4.

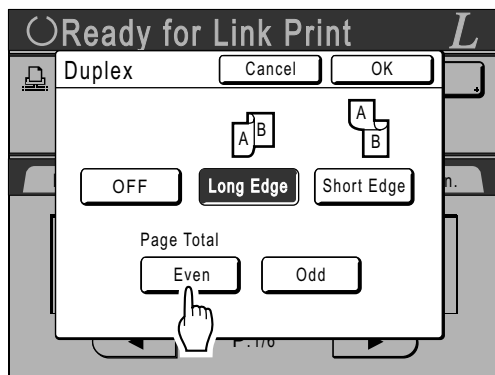
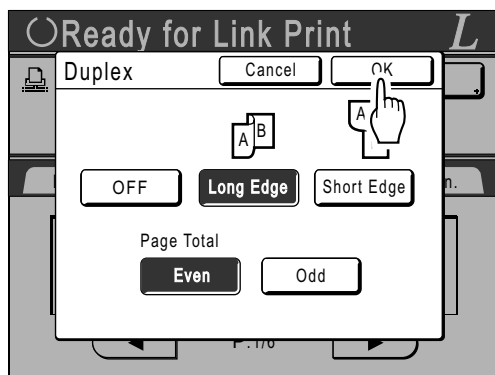
**4 Touch [OK].****Note:**

- To cancel Duplex Printing, touch [OFF] then [OK].

5 Place the original.**Note:**

- For information about placing the original, see step 4, "Printing from a Paper Document or Book". (p.39)
- To scan a single sheet of an original, place it on the Glass Platen.
- When Duplex Printing from odd number of originals scanned in the ADF unit, the reverse side of the last page will be blank.

6 Select Print functions as needed.

The following functions are available:

- Image Processing mode (p.56)
- Scanning Contrast (p.58)
- Size (p.59)
- Paper Size (p.63)
- Dot Process (p.65)
- Memory (p.134)
- Contrast Adj (p.66)
- Tone Curve (p.67)
- Book Shadow (p.81)
- Top Margin (p.83)
- Preview (p.87)
- Overlay (p.187)
- Storage Memory (p.183)
- My Direct Access (p.155)
- Reservation (p.142)

7 Enter the number of copies using the Print Quantity Keys.

The number is displayed on the Print Quantity Display.

Note:

- To change the number, press the **C** key, then re-enter the correct number.

8 Press the  key.

The next steps are different, depending on whether the original is scanned from Glass Platen, or from the ADF unit.

Perform one of the following steps:

Important!:

- Either Glass Platen or ADF unit may be used, but not both at a time.

When using a Linked Printer

◆ Using the Glass Platen

Place the first original document on the Glass Platen, wait for the message “Duplex Processing for Linked Printer” to disappear, then place the second original and press the  key.

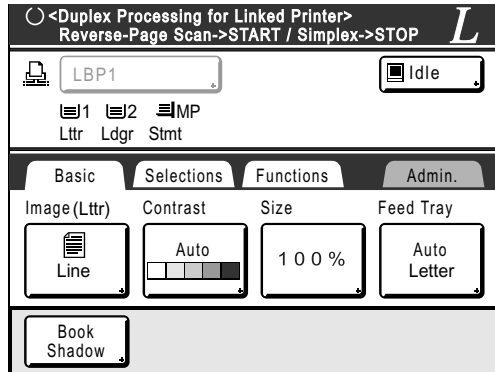

Once data for both sides of the paper is transmitted, the Linked Printer will print the specified number of copies.

To print multiple Duplex Print copies, repeat steps 5-8 of Duplex Printing.

Important!:

- Once the first original is scanned, the next original must be placed within pre-determined Duplex Interval period on the Admin. screen (p.164). Failure to do so will result in the Linked Printer printing one side only.

Note:

- Pressing the  key without placing the second original will also result in the Linked Printer printing one side only.
- Setting adjustment can be made on the following functions after placing the second original and before its scan starts:
 - Image Processing mode (p.56)
 - Scanning Contrast (p.58)
 - Size (p.59)
 - Dot Process (p.65)
 - Contrast Adj (p.66)
 - Tone Curve (p.67)
 - My Direct Access (p.155)

◆ Using the ADF unit

The top sheet is scanned first.
As each original page is scanned, the Linked Printer prints specified number of copies.

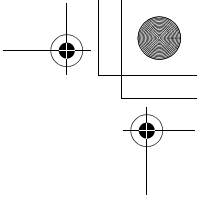

When using a Linked Printer

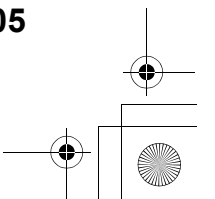
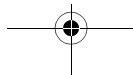
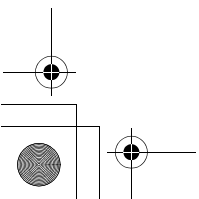
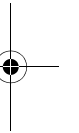
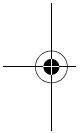

Replacing Consumables

Check for Remaining Amount of Consumables

The machine checks and reports on remaining amount of ink, master, as well as the space left in the disposal box.

Note:

- The report may not be displayed if detection fails.
- The reported amount is for reference only and may not be perfectly accurate.

1 Touch [i Info] on the Basic Screen.

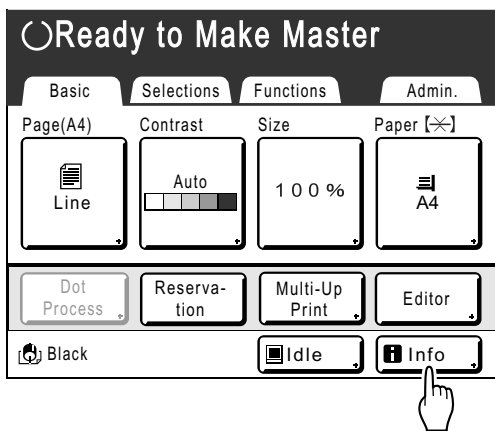

2 Check for remaining amount of consumables.

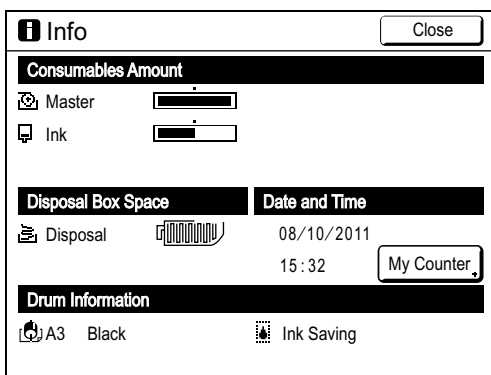

When running low, be sure to restock supply.

- Master (p.208)
- Ink (p.211)
- Master Disposal (used master) (p.213)

Display Details

Indicator/Message	Description
	The black bar indicates the remaining amount. Ex: approximately 10% left
(Unknown), ---, no display	Indicates that consumable data is not available, is not set, etc.



◆ About the “My Counter” screen

When the “Management Level” in the User Management is set to “High/Full Management”, touch **[My Counter]** to display “My Counter” screen.



On the “My Counter” screen, you can confirm the current user’s Limit C/C, M/C and Present C/C, M/C. Limit C/C and M/C are set by the administrator. Consult your administrator for details.

My Counter	
U-1(G-1)	
Limit C/C	10,000
Present C/C	6,511
Limit M/C	10,000
Present M/C	250



Tip:

 Information Button
 icon on the  Information Button displays current status of the consumables as detected by the machine.

The  icon will change depending on the matching information detected from the consumable.

- When matching information was correctly retrieved from the consumable  (normal display)
- When matching information is not available  (gray display)

When the  icon is grayed, the remaining amount of master/ink cannot be displayed.

When the master material or ink runs low,  (master) or  (ink) icon blinks on the right of the button to let you know that the item should soon be replaced.

Note:

- If the machine is unable to retrieve matching data from the consumable, you must enter the correct setting value.
p.239

Replacing Consumables

Replacing the Master Roll

When the Master Roll is depleted, a message is displayed and the machine stops. Replace with a new Master Roll.

Important!:

- For the Master Roll, it is recommended to use the products specified by Riso.
- Keep the power ON while replacing the master.

1 Open the Front Cover.

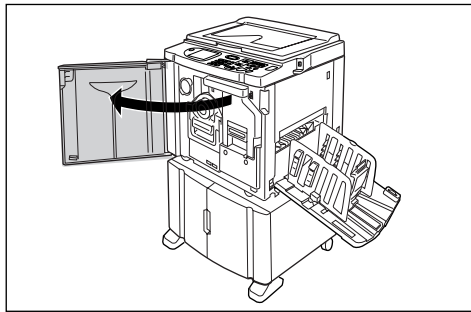

2 Check the indicator of the Master Making Unit Release Button is ON.

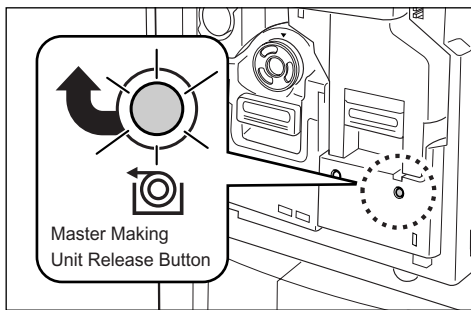

If the indicator is off, press the Master Making Unit Release Button to turn it on.

Important!:

- When the Print Drum (Cylinder) is out, Master Making Unit cannot be pulled out. Return the Print Drum (Cylinder) into position and press the Master Making Unit Release Button.
☞ p.215

3 Pull out the Master Making Unit.

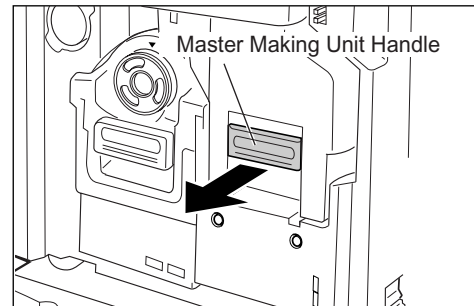

Grasp the Master Making Unit Handle and pull forward.

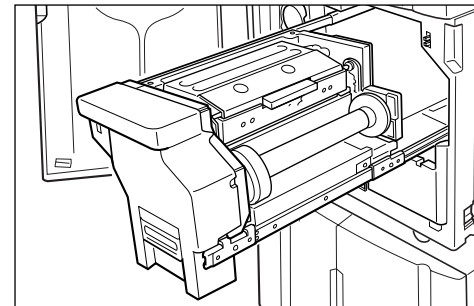

Pull out slowly until it stops.

4 Open the Master Making Unit Cover.

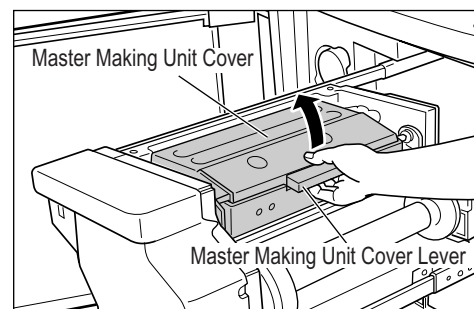

Grasp the Master Making Unit Cover Lever and open the Master Making Unit Cover.

5 Open the Master Roll Holder.

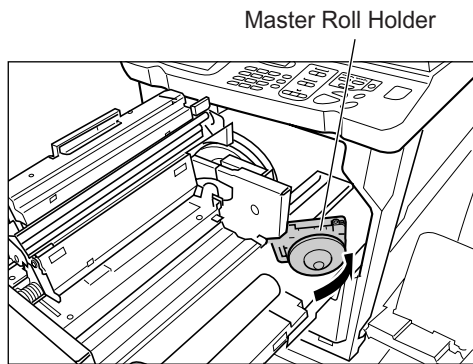

6 Remove the depleted Master core.

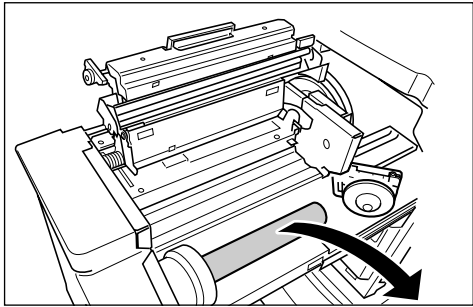

Note:

- Dispose the depleted master core according to the disposal rule of your local community. p.218

7 Install a new Master Roll.

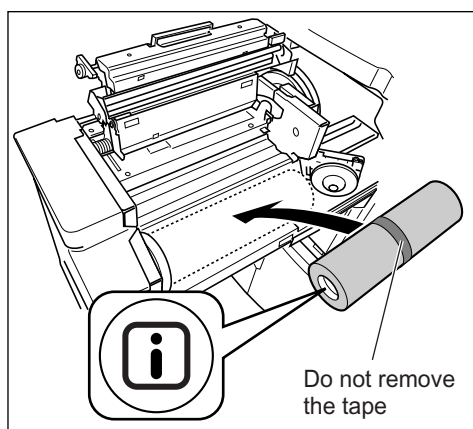

Remove the plastic shrink wrap from the new Master Roll, and place in with the **i** mark to the left.

Important!:

- Take care not to damage the **i** section when removing the shrink wrap. If the **i** section is bent or the perforation cut, the master will become unusable.
- Do not remove the tape yet.

8 Close the Master Roll Holder.

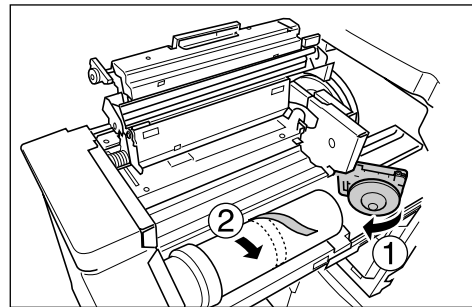

Remove the tape once the Master Roll Holder has been closed.

9 Insert the leading edge of the master under the Master Guide Flap.

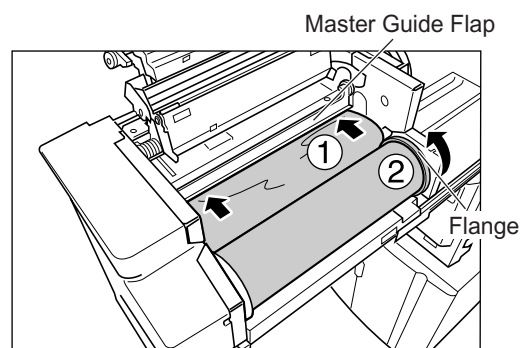

Insert the leading edge of the master into its entrance under the Master Guide Flap and advance it as far in as it will go (①). If the Master is loose, turn the flange at the right towards the rear and rewind (②).

Replacing Consumables

Tip:

If You Cannot Insert the Master

Insert the leading edge of the Master using the following steps.

- 1) Raise the Master Guide Flap
Turn the dial on the edge of the Master Guide Flap towards the rear and raise the Master Guide Flap.
- 2) Pull out the master to the line indicated by the arrow.
- 3) Lower the Master Guide Flap.

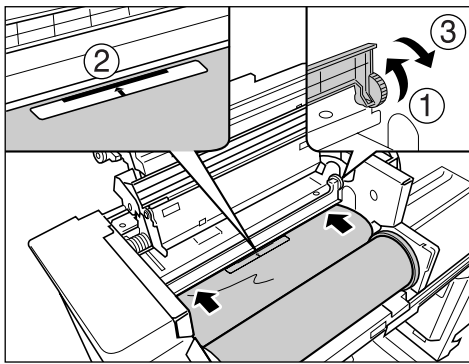

10 Return each part to its original position.

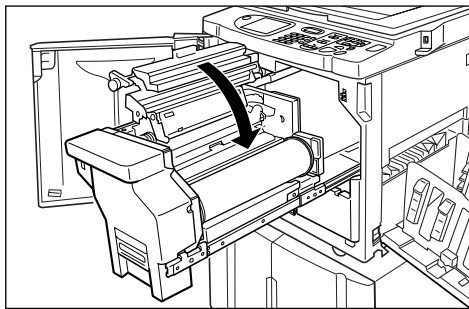

Close the Master Making Unit Cover.

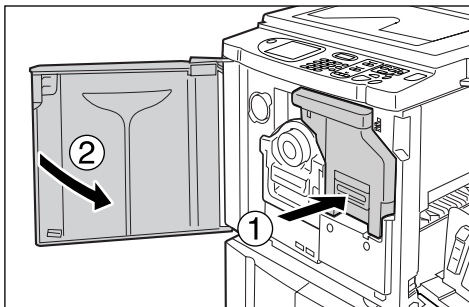

Return the Master Making Unit to its original position and close the Front Cover.

210 Replacing the Master Roll

Replacing the Ink Cartridge

When the ink is depleted, a message is displayed and the machine stops. Replace with a new Ink Cartridge.

⚠ Caution:

- Ink may be left on the area around the Print Drum (Cylinder), so take care not to smudge your hands or clothes.
- Wash immediately with soap if you should get ink on your hands, etc.

Important!:

- For the Ink Cartridge, it is recommended to use the products specified by RISO.
- Keep the power ON while replacing the Ink Cartridge.
- Replace with an Ink Cartridge of the same ink color (colour). If you want to change the ink color (colour), replace the Print Drum (Cylinder) itself.
☞ p.215

1 Open the Front Cover.

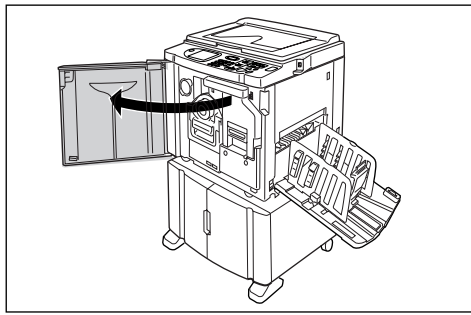

2 Pull the empty Ink Cartridge out of the holder.

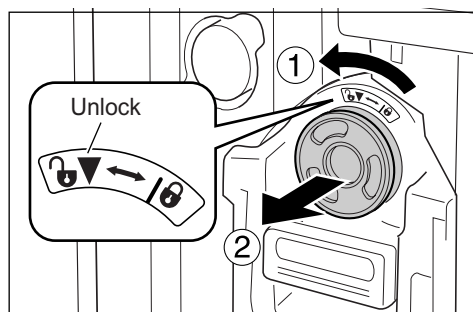

Turn the Ink Cartridge to the counter clockwise (🔓) and then pull it out.

Note:

- Dispose the empty Ink Cartridge according to the disposal rule of your local community.
☞ p.218

3 Remove the cap on the new Ink Cartridge.

Turn the Ink Cartridge cap to remove.

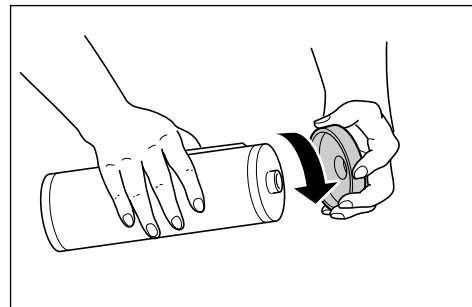

Important!:

- Do not touch or give impact to the outlet surface of the new Ink Cartridge.
Do not peel off the label beside the Ink Cartridge opening.

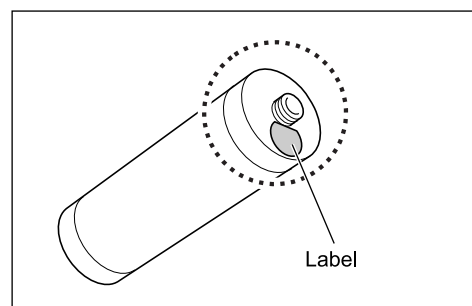

Replacing Consumables

Note:

- You can store the Ink Cartridge cap on the upper left of the Print Drum (Cylinder).

Ink Cartridge Cap Holder

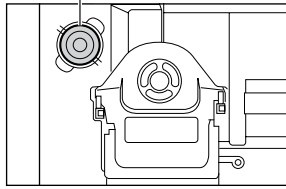

4 Insert the new Ink Cartridge.

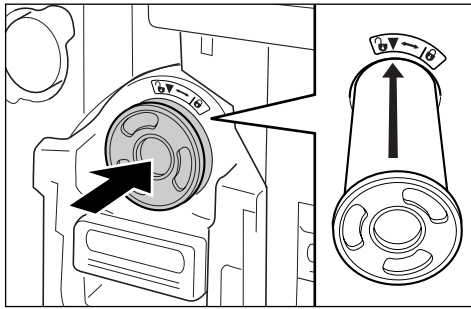

Align the arrow on the Ink Cartridge to the ▼ mark on the drum (cylinder) unit, and insert until it stops.

5 Lock the Ink Cartridge.

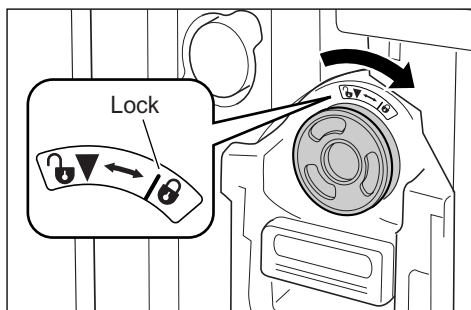

Turn the Ink Cartridge clockwise (🔒) and lock in position.

6 Close the Front Cover.

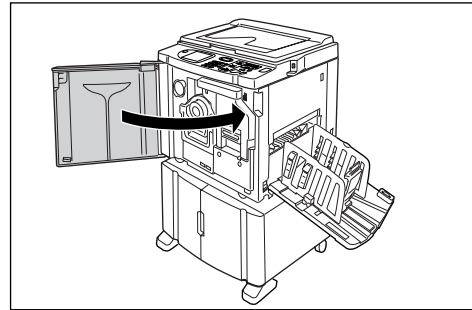

Emptying the Master Disposal Box

Used masters are held in the Master Disposal Box. When the Master Disposal Box becomes full, a message displays and the machine stops. Discard the used masters.

⚠ Caution:

- Wash immediately with soap if you should get ink on your hands, etc.

Important!:

- The Master Disposal Box can be padlocked to prevent the information contained in the discarded master from being leaked. If the Master Disposal Box is safely protected by the padlock, be sure to contact the administrator before discarding the master.
- When "Protect" is ON, you can remove the Master Disposal Box only when the messages such as "Master Disposal Box is Full" or "Master Jammed in Disposal Unit" are displayed. [p.173](#)

1 Remove the Master Disposal Box.

If the Master Disposal Box lever is locked, slide the lever to the right to unlock.

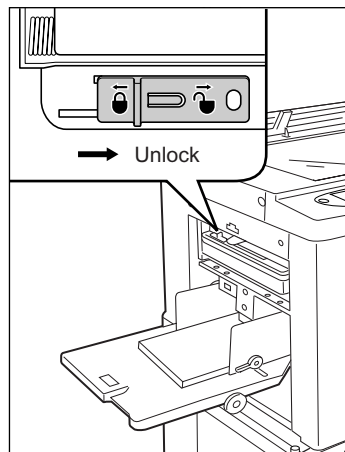

Grasp the Master Disposal Box handle and pull the box forward.

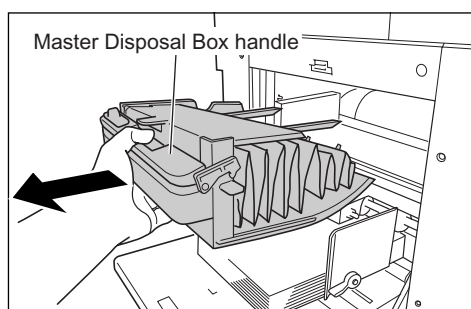

Important!:

- If the Master Disposal Box is padlocked, contact the administrator to undo the padlock.

2 Discard the ejected masters.

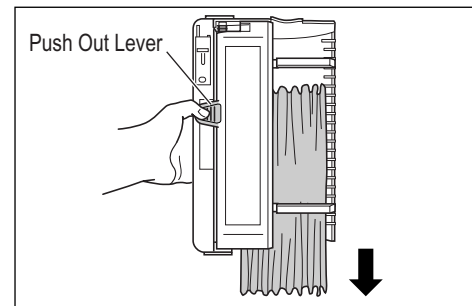

Tilt the Master Disposal Box forward and directly discard the used master into the garbage box (or bag) by grasping the Push Out Lever.

3 Place the Master Disposal Box into position.

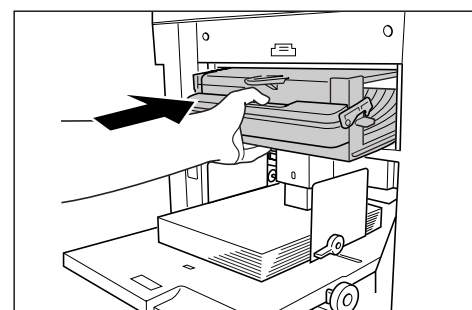

Insert the Master Disposal Box until it stops.

Replacing Consumables

Note:

- If necessary, slide the lever to the left to lock the Master Disposal Box and also have the padlock for further safety.
☞ p.173

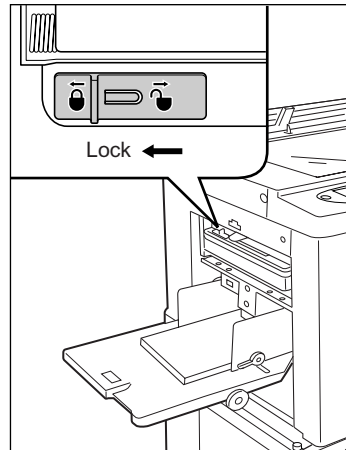

- Dispose the ejected masters according to the disposal rule of your local community.
☞ p.218

Replacing the Print Drum (Cylinder) (Color (colour) Change)

When replacing with a Color Drum (Cylinder) to change colors (colours), or when removing jammed paper, follow the steps to remove Print Drum (Cylinder). Be sure to use a Color Drum (Cylinder) specifically designed and approved for use with this machine.

⚠ Caution:

- Do not stand the Print Drum (Cylinder) upright. Doing so may stain the floor, etc.

Important!:

- Use only Print Drums (Cylinders) specifically designed and approved for use with this machine.
- Keep the power ON while removing or replacing the Print Drum (Cylinder).
- Make sure to place the changed Print Drum (Cylinder) into the drum (cylinder) case and store horizontally.

Removing the Print Drum (Cylinder)

1 Open the Front Cover.

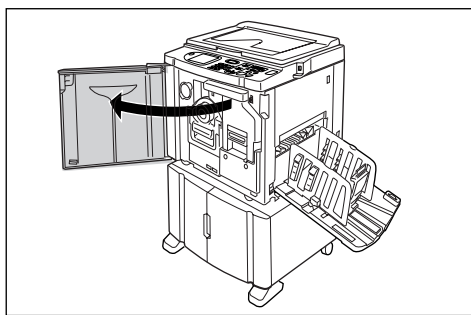

2 Check that the indicator of the Print Drum (Cylinder) Release Button is ON.

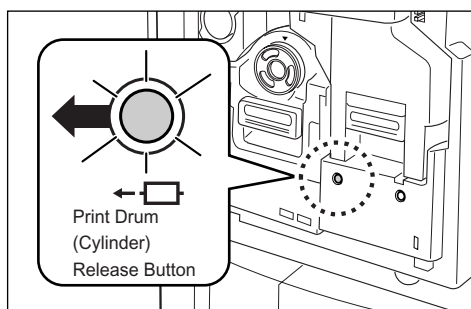

If the indicator is off, press the Print Drum (Cylinder) Release Button to turn it on.

Important!:

- When the Master Making Unit is out, the Print Drum (Cylinder) cannot be pulled out. Return the Master Making Unit into position and press the Print Drum (Cylinder) Release button.
☞ p.208

3 Pull out the Print Drum (Cylinder).

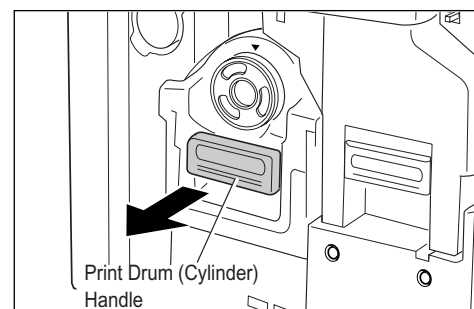

Grasp the Print Drum (Cylinder) Handle and slowly pull until the Print Drum (Cylinder) is completely extended.

Replacing Consumables

4 Remove the Print Drum (Cylinder).

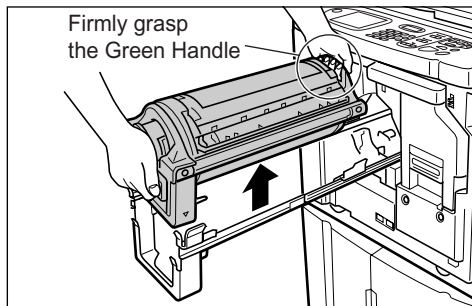

Use both hands to lift the Print Drum (Cylinder) straight up to remove from the rail. Proceed with replacing the drum (cylinder), removing the paper jam, etc..

⚠ Caution:

- Do not touch the connector on the Print Drum (Cylinder). Neglecting this may result in malfunction of the Print Drum (Cylinder) because of static electricity or other factors.

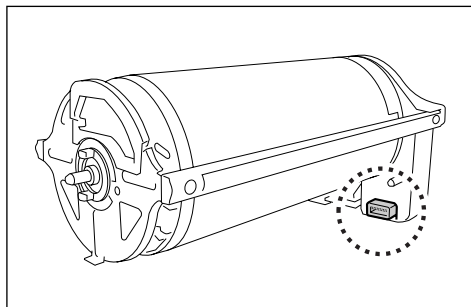

Installing the Print Drum (Cylinder)

1 Place the Print Drum (Cylinder) on the Rail.

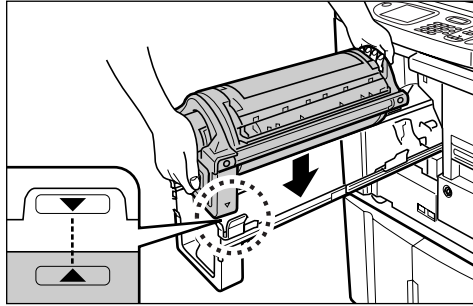

Align the ▼ mark on the Print Drum (Cylinder) with the ▲ mark on the guide, and place the Print Drum (Cylinder) horizontally onto the rail.

Note:

- If the Print Drum (Cylinder) was manually rotated, be sure to turn it back so that ► and ◀ marks align, after it is placed on the rail.

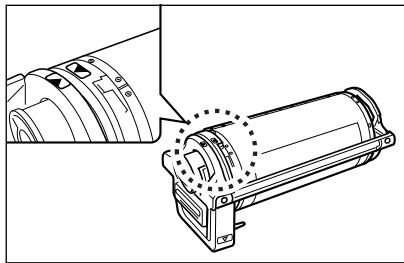

2 Return the Print Drum (Cylinder) to its original position.

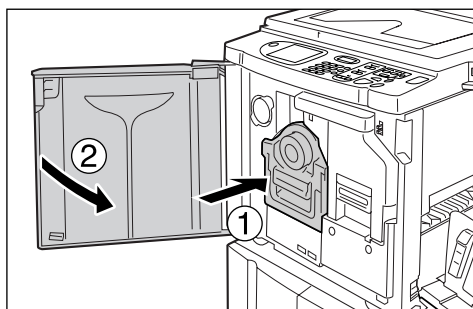

Push the Print Drum (Cylinder) in as far as it will go, and then close the Front Cover.

Important!:

- Do not grasp the Print Drum (Cylinder) Handle when pushing in the Print Drum (Cylinder).

Tip:

Changing the Drum (Cylinder) Type

When you install a different type of Print Drum (Cylinder), the Confirm Drum (Cylinder) Type screen appears.

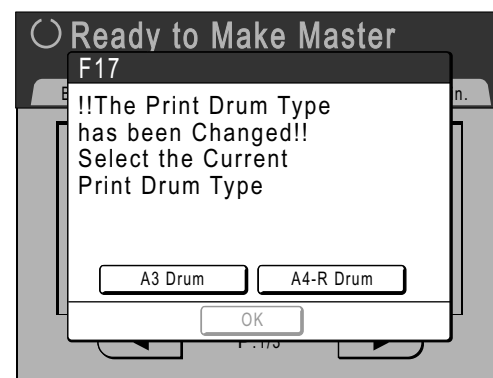

- 1) Select the type corresponding to the installed Print Drum (Cylinder).
- 2) Touch [OK].
The Print Drum (Cylinder) type is confirmed and printing is enabled.

Important!:

- You will not be able to print until the Print Drum (Cylinder) type is confirmed.
- If you install a non-approved Color Drum (Cylinder), the message "Wrong-Type Print Drum (Cylinder) Installed Replace with Correct Type" is displayed. Install a Color Drum (Cylinder) specifically approved for use with this machine.

Replacing Consumables

Disposal of Depleted Consumables

Dispose of depleted Ink Cartridges, Master cores, ejected masters according to the regulations in your local community.

If required, separate the specific components using the following procedures to dispose them properly.

◆ Ink Cartridge

Remove the label (metal included) at the arrow from the outlet surface of the Ink Cartridge, and then dispose them separately.

Because ink may have adhered to the outlet surface of the Ink Cartridge, be careful not to smudge your clothes.

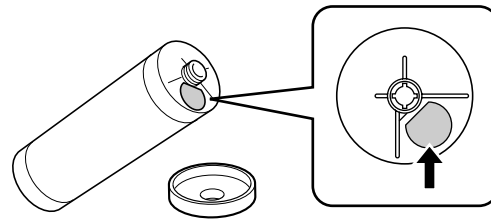

Parts	Materials
Ink Cartridge material	plastic (polypropylene/polyethylene)
Label material	plastic (metal included)
Ink	Soy oil, petroleum hydrocarbons, water, pigments

◆ Master core

A metallic component has been attached to the bottom of the end section having the  mark stamped.

Because the component section has been perforated for cutout convenience, tear along the perforation for proper disposal.

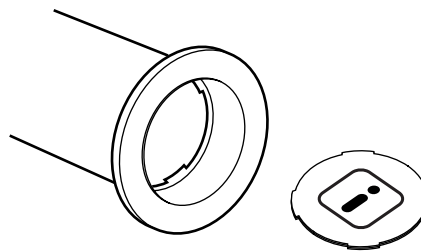

Parts	Materials
Core material	Paper
Master material	plastic, Japanese paper
Material of the cutout component	plastic (metal included) and paper

◆ Ejected Master

Parts	Materials
Master material	plastic, Japanese paper
Ink material	Soy oil, petroleum hydrocarbons, water, pigments

Note:

- It is made of carbon and hydrogen compounds. If fully combusted, it will turn into water and carbon dioxide.

Maintenance

Cleaning

The print quality may suffer if parts such as Thermal Print Head of the Master Making Unit, Scanner Glass of the ADF unit (Option), White Roller, etc. are contaminated with dust, dirt, ink, white-out, etc.

Follow the steps below for periodic cleaning.

▲WARNING:

- Before cleaning any part of the machine, turn off the power.
- Do not remove any fixed covers.
- Contact your service representative immediately if you suspect any dangerous situations or have questions or problems with the machine.
- Contact your service representative before moving the machine.
- Do not allow unauthorized persons to make adjustments or repairs.

▲Caution:

- The machine has precision moving parts inside. Do not handle the machine in any other way than described in this manual.
- Be careful of the edge of metal parts, otherwise it may cause an injury.
- Do not make any modifications to the machine or remove any parts.
- Neither RISO nor its dealer is responsible for maintenance service performed by non-RISO-authorized personnel.

Thermal Print Head

Clean the Thermal Print Head each time you replace the Master Roll.
Open the Master Making Unit Cover, and gently wipe the Thermal Print Head in the back of the unit several times with a soft cloth or tissue.

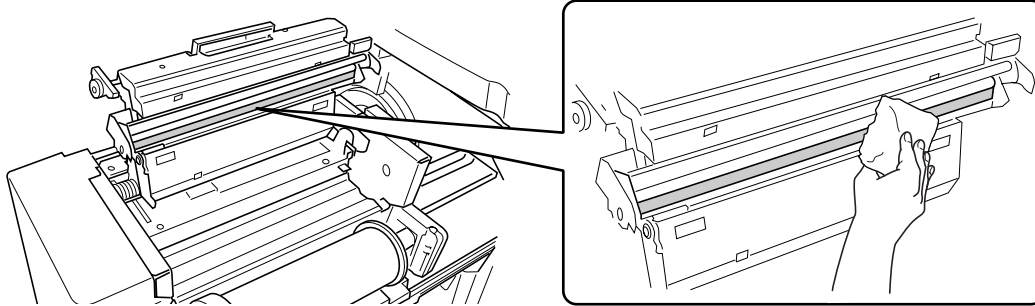

⚠ Caution:

- Since the Thermal Print Head is very delicate, avoid shocks or scratches with a hard object.
- Since Thermal Print Head is susceptible to (damage by) static electricity, please be sure to remove the static electricity charged in the body before cleaning.

Glass Platen and Platen Cover Pad

If the Glass Platen and/or Platen Cover Pad is stained, gently wipe them with a soft cloth or tissue.

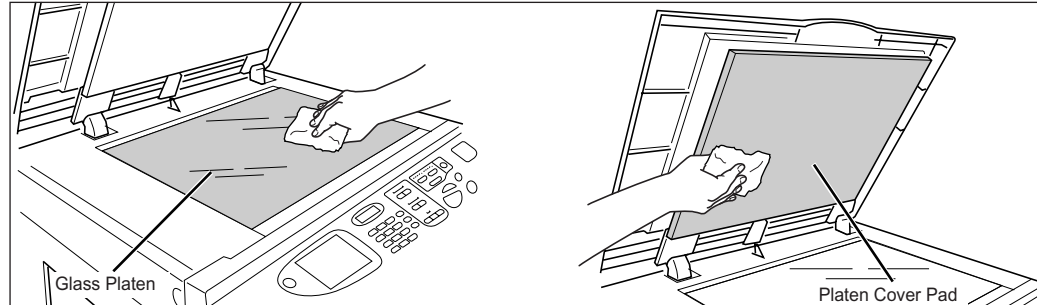

⚠ Caution:

- Since the Glass Platen is very delicate, avoid shocks or scratches with a hard object.

Maintenance

Scanner Glass and White Roller of ADF unit (Option)

Gently wipe the Scanner Glass, and the White Roller several times with a soft cloth or tissue.

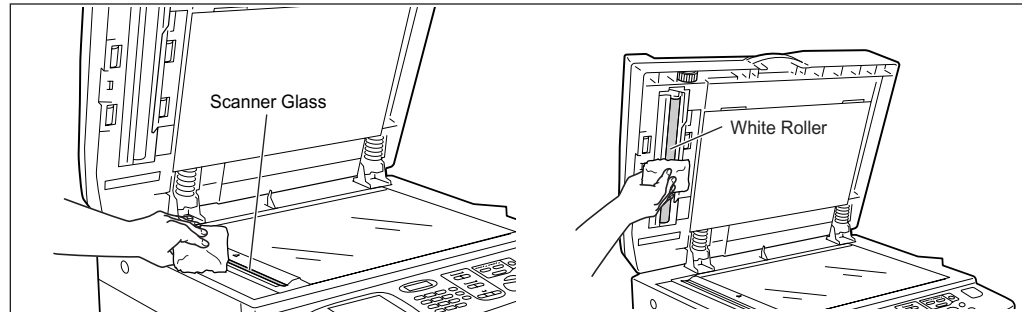

⚠ Caution:

- Since the Glass Platen is very delicate, avoid shocks or scratches with a hard object.

Pressure Roller

If the Pressure Roller, which presses print paper against the Print Drum (Cylinder), is stained, smudged strips may appear on the back of copies.

If this happens, gently wipe the Pressure Roller with a soft cloth dampened with alcohol.

To remove the Print Drum (Cylinder), see p.215.

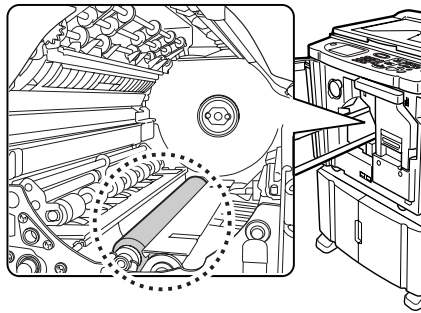

⚠ Caution:

- Be sure to turn OFF power to the machine when cleaning the Pressure Roller.
- When putting your hand into the unit, do not touch the paper separation hook or master removal hook. The sharp tips of the hooks can hurt your hand.
- Ink may be left on the area near the Print Drum (Cylinder), so take care not to smudge your hands or clothes. Wash immediately with soap if you should get ink on your hands, etc.

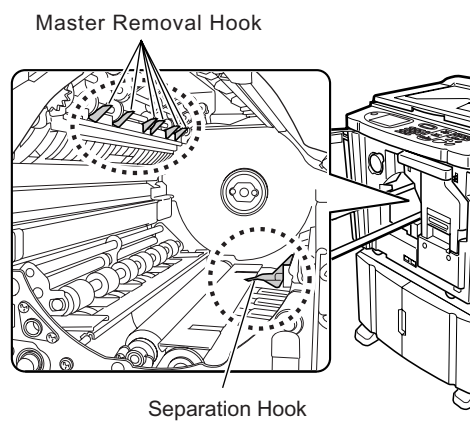

The Exterior

Use a soft cloth to gently wipe down the entire printer on a regular basis in order to prevent the exterior from getting dirty.

If using a cleaning agent, use one recommended by your authorized service representative.

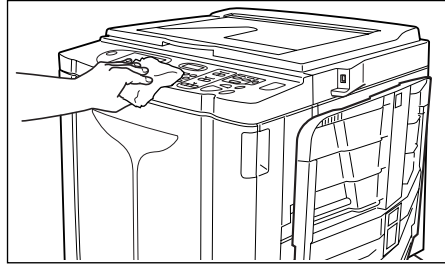

⚠ Caution:

- Because the machine exterior is plastic, never use alcohol or solvent when cleaning.
- The Display may be cleaned by gently wiping with a dry cloth. Dampen a cloth with a small amount of cleaner and gently wipe to remove any ink.
Do not spray or pour cleaner solution directly onto the display. Doing so can cause damage.

Troubleshooting

When a Message Displays

Refer to the following information to determine the cause and take appropriate actions when the machine stops operating and a message is displayed.

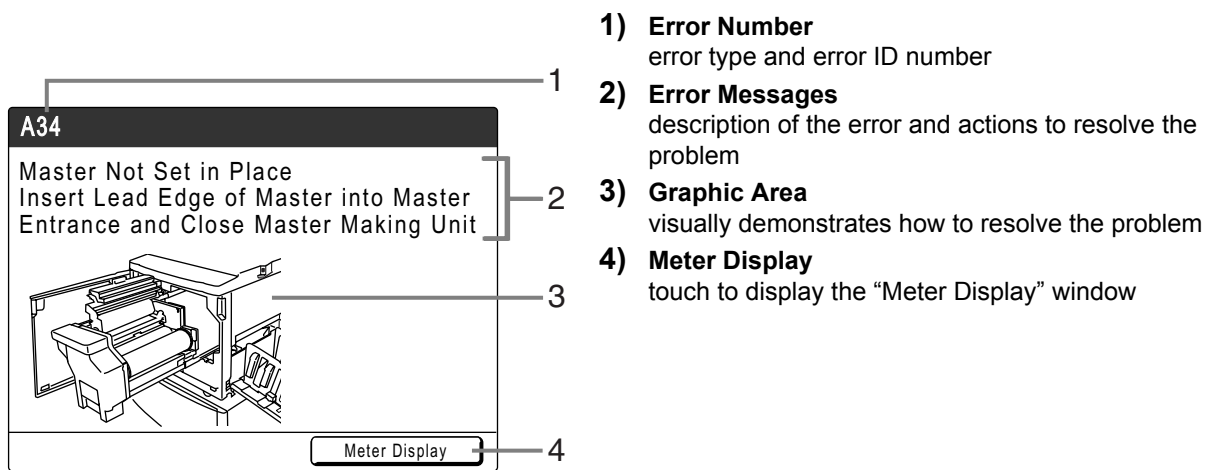

Error Message Layout

A message and a troubleshooting illustration will be displayed in accordance with the message type to show how to resolve the problem.









Error Number	Error Types	Description	Reference page
T00-000	Service Call Errors	Errors that require repair or inspection by an authorized service representative. To resolve a Service Call Error, contact your dealer (or authorized service representative) with the error number.	p.225
A00-000	Master Jam Errors	Displays when the master is jammed, etc..	p.225
B00-000	Optional Device Errors	Displays when an error occurs on the optional device.	p.226
C00-000	Consumable Errors	Displays when a consumable such as ink or master roll is depleted.	p.227
D00-000	Installation Errors	Displays when a part or unit is not properly installed.	p.228
J00-000	Paper Jam Errors	Displays when an original document or printing paper is jammed.	p.230



T00-000:Service Call Errors (in alphabetical order)

Message	Possible Cause	Action
!!Battery Replacement!! Call Service	The battery is low or depleted.	Contact your dealer (or authorized service representative) and have the battery replaced. Press the  key or the  key to clear the error message display.
!!System Error!! Press Reset Key If Recovery has Failed, Call Service	A system error has occurred.	Press the  key. If the problem persists, contact your dealer (or authorized service representative).
!!System Error!! Turn Main Power SW OFF Then ON If Recovery has Failed, Call Service		Shut off power, then restart. If the problem persists, contact your dealer (or authorized service representative).

A00-000:Master Jam Errors (in alphabetical order)

Message	Possible Cause	Action
Master Disposal Error Pull Out Print Drum (Cylinder) and Discard Master	The master was not properly discarded.	<ol style="list-style-type: none"> 1) Pull out the Print Drum (Cylinder) and remove the master from the drum (cylinder).  p.215 2) Return the Print Drum (Cylinder) in place. 3) Press the  key.
Master Jammed in Disposal Unit Pull Out Master Disposal Box and Remove Jammed Master	The master is jammed in the Master Disposal Unit.	Pull out the Master Disposal Box and remove the jammed master. If the masters are difficult to remove, pull out the Print Drum (Cylinder) and then remove.  p.213 If the error persists, contact your dealer (or authorized service representative).
Master Loading Error Pull Out Print Drum (Cylinder) and Discard Master	The master did not properly attach to the Print Drum (Cylinder).	<ol style="list-style-type: none"> 1) Pull out the Print Drum (Cylinder) and remove the master from the drum (cylinder).  p.215 2) Return the Print Drum (Cylinder) in place. 3) Press the  key.
Master Mis-Feed Pull Out Master Making Unit and Rewind Master Roll, then Reset Master in Place	The master is improperly installed.	Pull out the Master Making Unit, rewind the master and reinstall.  p.208
Master Not Set in Place Insert Lead Edge of Master into Master Entrance and Close Master Making Unit	The master is improperly installed or is missing.	Pull out the Master Making Unit and reinstall the master.  p.208 Important!: <ul style="list-style-type: none"> • If the leading edge of the master is wrinkled or torn, cut the edge straight and reinstall.

Troubleshooting

Message	Possible Cause	Action
Master Remains on Print Drum (Cylinder) Pull Out Print Drum (Cylinder) and Remove Master	An unnecessary master remains on the Print Drum (Cylinder).	<ol style="list-style-type: none"> 1) Pull out the Print Drum (Cylinder) and remove the master from the drum (cylinder). ☞ p.215 2) Return the Print Drum (Cylinder) in place. 3) Press the  key.
Paper Jam Remove Paper in Indicated Areas and Press [OK] Button	Paper jammed in indicated area.	<ol style="list-style-type: none"> 1) Remove the jammed paper. 2) Press the  key or touch [OK].
Safety SW on Standard Feed Tray is Activated Reset paper on Standard Feed Tray	The safety switch for the Standard Feed Tray (Paper Feed Tray) has been activated.	Check underneath the Standard Feed Tray (Paper Feed Tray) and on top of the printing paper for any obstructions. Remove if any exist.
System Error in Master Making Unit Take Out Master and then Close Master Making Unit Cover	The cutter mechanism for the master malfunctioned.	<p>Pull out the Master Making Unit and remove the master. ☞ p.208</p> <p>Closing the Master Making Unit Cover will reset the error. Setup the master again.</p>

B00-000:Optional Device Errors (in alphabetical order)

Message	Possible Cause	Action
Can not identify	<ul style="list-style-type: none"> • Something other than the USB Flash Drive is connected to the USB slot. • A defective USB Flash Drive is connected to the USB slot. • A USB Flash Drive not recognized for this machine is connected to the USB slot. 	<p>Connect a USB Flash Drive for this machine. ☞ p.12</p>
Can not identify (USB hub)	A USB hub is connected to the USB slot.	<p>Connect the correct corresponding USB Flash Drive. ☞ p.12</p>
Insert Card in Key/Card Counter	No card in the Key Card Counter (option).	Insert Card in the Key Card Counter.
!! Job Separator is OFF !! Turn On Power Switch of it	The Job Separator (option) is turned OFF.	Turn on the Job Separator.
Linked Printer in Error	A Service Call Error has occurred on the Linked Printer.	Check the Linked Printer and resolve the error.
No IP Address Assigned to This Printer Contact Your Network Administrator	IP address for the machine is not properly set.	<p>Contact your system administrator and set the machine IP address correctly. ☞ p.161</p>

Message	Possible Cause	Action
!! No Linked Printer Detected !! Check Cable Connection and Power Supply for Linked Printer	Linked Printer may not be turned ON; cable may not be properly connected; connection may be interrupted.	Check that the Linked Printer has been switched on. Check to make sure all cables are properly connected. If properly connected, check the server and network communication status and consult with the server and network communication administrator.
No Paper Tape in Job Separator Replace Tape Roll	No tape in the Job Separator (option).	Load new tape into the Job Separator.
No Toner in Linked Printer	No toner in the Linked Printer.	Replace toner in the Linked Printer.
Paper Jam Remove Paper in Indicated Areas and Press [OK] Button	Paper jammed in indicated area.	1) Remove the jammed paper. 2) Press the  key or touch [OK] .
Paper Tape Jam in Job Separator Remove Paper Tape	Tape jam occurred in the Job Separator (option).	Check the Job Separator and remove jammed tape.
!!System Error!! Turn Main Power SW OFF Then ON If Recovery has Failed, Call Service	A system error has occurred.	Shut off power, then restart. If recovery has failed, contact your dealer (or authorized service representative).

C00-000:Consumable Errors (in alphabetical order)



Message	Possible Cause	Action
Add Paper	No printing paper in the Paper Feed Tray.	Load paper into the Paper Feed Tray. ☞ p.32
Master Disposal Box is Full Empty Master Disposal Box	The Master Disposal Box is full.	Empty the Master Disposal Box. ☞ p.213
No Ink Replace Ink Cartridge	The ink is depleted.	Replace and install a new Ink Cartridge. Use the Ink Cartridge specifically designed and approved for use with this machine ☞ p.211 Important!: • If the error persists after replacing the Ink Cartridge, check for proper installation of the Ink Cartridge.
No Master Replace Master Roll	The Master Roll is depleted.	Install a new Master Roll. Use Master Roll specifically designed and approved for use with this machine ☞ p.208

Troubleshooting

D00-000:Installation Errors (in alphabetical order)

Message	Possible Cause	Action
Close Front Cover	The Front Cover is open or improperly closed.	Check for the magnet underneath the Front Cover and firmly close.
Close Master Making Unit Cover	The Master Making Unit Cover is open or is improperly installed.	Pull out the Master Making Unit, check and firmly close its cover.
Install Ink Cartridge	The Ink Cartridge is improperly installed or is missing.	Properly install the Ink Cartridge. ☞ p.211
Master Making Unit has been Unlocked	The Master Making Unit is ready to be pulled out.	Pull out the Master Making Unit.
Print Drum (Cylinder) has been Unlocked	The Print Drum (Cylinder) is ready to be pulled out.	Pull out the Print Drum (Cylinder).
Print Drum (Cylinder) Not Set in Place Press Print Drum (Cylinder) Release Button and Pull Out Print Drum (Cylinder) after the Button Lights	The Print Drum (Cylinder) is locked but not pushed in properly.	Push the Print Drum (Cylinder) in as far as it will go and press the Print Drum (Cylinder) Release Button . Remove the Print Drum (Cylinder) after the button is lit and reinstall.
Rear Cover of Main Body is Off Call Service	The machine rear cover is removed.	Contact your dealer (or authorized service representative).
Set Master Disposal Box in Place	The Master Disposal Box is improperly set or is missing.	Properly set the Master Disposal Box. ☞ p.213
Set Master in Place	No master is installed.	Install a Master Roll. ☞ p.208
Set Master Making Unit in Place	The Master Making Unit is missing or is improperly installed.	Properly install the Master Making Unit. ☞ p.208
Set Print Drum (Cylinder) in Place	The Print Drum (Cylinder) is improperly set or is missing.	Properly install the Print Drum (Cylinder). ☞ p.215
Wrong-type Ink Cartridge Installed or Cannot Read Ink Info Replace Ink Cartridge or Contact dealer/Riso office	Inappropriate Ink Cartridge is installed.	Properly install a correct Ink Cartridge. ☞ p.211 Important!: • Use the Ink Cartridge specifically designed and approved for use with this machine. Failure to do so may cause problems or damage to the machine.
	The label on the Ink Cartridge outlet surface has come off or surface is with dirt.	The label on the Ink Cartridge outlet surface contains information needed for printing. If the machine cannot read the information, it does not operate. Set an Ink Cartridge that is specific to the machine and that is with label attachment and free from dirt.

Troubleshooting

Message	Possible Cause	Action
Wrong-type Master Installed or Cannot Read Master Info Replace Master Roll or Contact dealer/Riso office	Incorrect master is installed.	Set a correct Master Roll. ☞ p.208 Important!: • Use a Master Roll specifically designed and approved for use with this machine. Failure to do so may cause problems or damage to the machine.
	The  section on the master core is missing, or it has worn off, or it has been tilted.	The  section on the master core contains information needed for making masters. If the machine cannot read the information, it does not operate. Set a dedicated Master Roll that has the  mark and is free from wear and tilt.
Wrong-Type Print Drum (Cylinder) Installed Replace with Correct Type	Incorrect Print Drum (Cylinder) is installed.	Install a correct Print Drum (Cylinder). ☞ p.215 Important!: • Use a Print Drum (Cylinder) specifically designed and approved for use with this machine. Failure to do so may cause problems or damage to the machine.

Troubleshooting

J00-000:Paper Jam Errors

Displays when the original document or printing paper is jammed inside the machine, the ADF unit (Option) or Sorter (option). The location of the paper jam is indicated by the flashing icon (①-⑤) in the illustration. Refer to the table below (①-⑤) and resolve the issue as indicated.

Note:

- Use appropriate printing paper to prevent paper jams. Also select appropriate original document suitable for the ADF unit (Option).
 - ☞ p.15
 - ☞ p.17

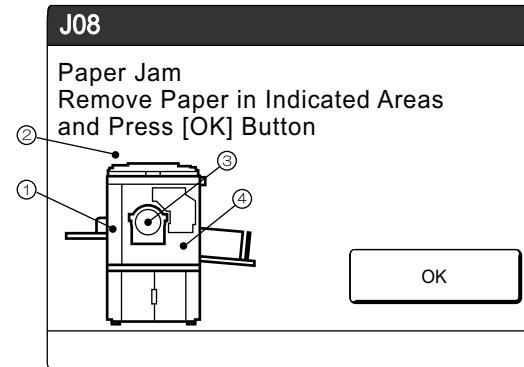

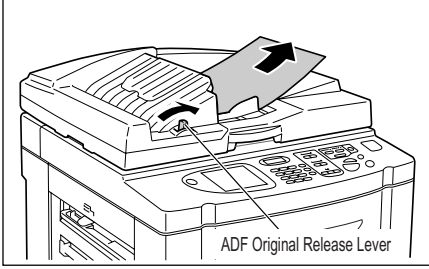
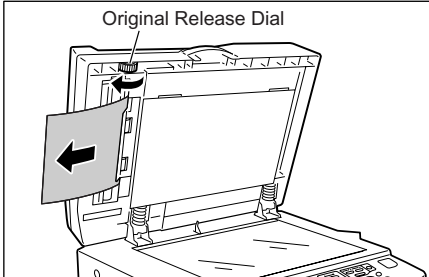
Area Indicated/ Blinking	Possible Cause	Action
①	Paper is jammed in the Paper Feed area.	<ol style="list-style-type: none"> 1) Check the paper feed side and remove the jammed paper. 2) Reload printing paper. 3) Press the  key if error display does not clear. When using special paper, adjust the Paper Feed Pressure Adjustment Lever according to the paper characteristics. ☞ p.33
②	The original is jammed in the ADF unit (Option).	<p>Removing in the document insertion direction Pull the ADF Original Release Lever (Option) to the right, and remove the original.</p>  <p>When removing in the document ejection direction Raise the Platen Cover, turn the ADF Original Release Dial and remove the original.</p> 

Area Indicated/ Blinking	Possible Cause	Action
③	Paper is jammed in the Print Drum (Cylinder) area.	<ol style="list-style-type: none"> 1) Pull out the Print Drum (Cylinder). ☞ p.215 2) Remove the jammed paper. 3) Return the Print Drum (Cylinder) in place. 4) Touch [OK]. <p>⚠ Caution:</p> <ul style="list-style-type: none"> • Do not touch the separation hook or master removal hook when putting your hand into the unit to remove paper. The sharp tips of the hooks can hurt your hand. <div data-bbox="1112 1023 1528 1366" style="text-align: center;"> <p>The diagram shows a cross-section of the printer's internal mechanism. Two hooks are labeled: 'Master Removal Hook' and 'Separation Hook'. The Master Removal Hook is a larger, curved hook, and the Separation Hook is a smaller, sharper hook. They are positioned near the print drum and paper path.</p> </div>
④	Paper did not eject correctly.	<ol style="list-style-type: none"> 1) Check for any jammed paper on the paper exit area. 2) Touch [OK]. <p>Note:</p> <ul style="list-style-type: none"> • When using special paper, adjust the Paper Arranger on the Receiving Tray Paper Guides according to the paper characteristics. ☞ p.32

Troubleshooting

Pop-Up Message Layout



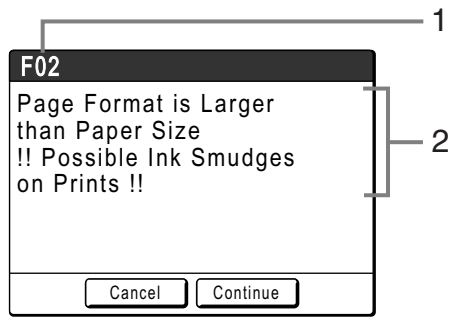

Pop-Up Messages communicates various operational statuses. You can continue operation over some of them, but depending upon the context, others will require your action before operations can be resumed.









- 1) **Error Number**
A reference letter (E/F) and an ID number.
- 2) **Pop-Up Messages**
Content of the message.

Error Number	Error Types	Description	Reference page
E00-000	Maintenance Call	Pops up when battery replacement or a routine inspection by a service personnel is required.	p.232
F00-000	Warning Messages	Pops up when printing job cannot proceed due to a conflict between a Control Panel setting and the status of the machine.	p.233















E00-000:Maintenance Call (in alphabetical order)







Message	Symptom/Action	How to Clear a Pop-Up Message
!!Battery Replacement!! Call Service	(Symptom) Low battery. (Action) Contact your dealer (or authorized service representative) and have the battery replaced.	Touch [Close] . (Alternatively, press the  key or the  key to clear.)
!!Maintenance!! Call Service	(Symptom) Notifies user of need for a periodic maintenance. (Action) Consult your dealer (or authorized service representative).	Touch [Close] . (Alternatively, press the  key or the  key to clear.)

F00-000:Warning Messages (in alphabetical order)















Message	Symptom/Action	How to Clear a Pop-Up Message
Acquiring Linked Printer Configuration Data Please Wait a Moment	<p>(Symptom) The machine system is retrieving Linked Printer information. Link Mode printing is disabled while the retrieval is underway.</p> <p>(Action) Start printing after the information has been completely retrieved from Linked Printer. Or, print from the machine.</p>	<p>Touch [Close] to clear the Pop-Up Message and return to the previous screen.</p> <ul style="list-style-type: none"> • When printing from the machine; Press the  key or the  key. • When printing from a Linked Printer; Wait until the information has been retrieved. (This may take several minutes.)
Auto Page Size Selection is Not Available for Irregular-Size Original Select Format Size to Store and then Restart	<p>(Cause 1) Attempting to scan an irregular-size original using "Auto" in scanning mode.</p> <p>(Action) Select the original size manually.</p> <p>(Cause 2) A normal-size original has been set in the wrong position.</p> <p>(Action) Lift the Platen Cover Pad up and set the original correctly.</p>	<ul style="list-style-type: none"> • To specify the format for saving Touch [Saving Format]. • To cancel scanning Touch [Cancel]. (Alternatively, press the  key or the  key to clear.)
!!Auto-Link Operation is Not Available!! Specified Linked Printer may be in Error or Turned OFF	<p>(Symptom) Linked Printer is sending an error signal. Link Mode has been activated due to low print volume since "Link-Free Volume" is currently set to ON.</p> <p>(Action) After canceling the Linked Printer error, print again. Or, print after switching to another Linked Printer or print from the machine. ☞ p.164</p>	<ul style="list-style-type: none"> • When returning to the Master Screen; Touch [Cancel]. (Alternatively, press the  key or the  key to clear.) • When changing to another available Linked Printer; Touch [Link Switch] and select another Linked Printer on the Link Sw. screen. ([Link Switch] will not display if no other Linked Printer is available.) ☞ p.198













Troubleshooting

Message	Symptom/Action	How to Clear a Pop-Up Message
Auto Paper Size Selection is Not Available for Irregular-Size Original Select Paper Size Manually and then Press START Key	<p>(Cause 1) Attempting to copy an irregular-size original using "Auto".</p> <p>(Action) Select a Feed Tray with the correct size paper.</p> <p>(Cause 2) A normal-size original has been set in the wrong position.</p> <p>(Action) Lift the Platen Cover Pad up and set the original correctly.</p>	<ul style="list-style-type: none"> • To select the Feed Tray Touch the button of the Feed Tray you wish to use. • To stop the print job; Touch [Cancel]. (Alternatively, press the  key or the  key to clear.)
!! Book Shadow Editor is Not Available with ADF !! Place Original on Glass Platen	<p>(Symptom) ADF is disabled while Book Shadow function is active.</p> <p>(Action) Place the original on the Glass Platen. p.81</p>	Touch [Close] . (Alternatively, press the  key or the  key to clear.)
Check Stock of Required Ink and Please Order If Needed	<p>(Symptom) The remaining quantity of Ink Cartridge or Master Roll has become less than specified on "Stock Management". p.163</p>	Touch [Close] . (Alternatively, press the  key or the  key to clear.)
Check Stock of Required Master and Please Order If Needed	<p>(Action) Order Ink Cartridges or Master Rolls if necessary.</p>	Touch [Close] . (Alternatively, press the  key or the  key to clear.)
Check the Original Size The Original Size is larger than Max. Printing Area	<p>(Symptom) As the original size is larger than the maximum printing area, extra areas may not be printed.</p> <p>(Action) Modify the reproduction size.</p>	<ul style="list-style-type: none"> • To change the "Size" setting; Touch [Size Setting]. • When resuming the print job; Touch [Continue]. (Alternatively, press the  key to print.) • When stopping the print job; Touch [Cancel]. (Alternatively, press the  key or the  key to clear.)
Check the Settings The Selected Reproduction Ratio will not fit the Max. Printing Area	<p>(Symptom) Reproduction size is too large for the detected original size and exceeds the maximum printing area.</p> <p>(Action) Modify the reproduction size.</p>	<ul style="list-style-type: none"> • When changing the "Size" setting; Touch [Size Setting]. • When resuming the print job; Touch [Continue]. (Alternatively, press the  key to print.) • When stopping the print job; Touch [Cancel]. (Alternatively, press the  key or the  key to clear.)









Message	Symptom/Action	How to Clear a Pop-Up Message
<p>Close Platen Cover</p> <p>If original moves you may not get desired result</p>	<p>(Symptom) The Platen Cover was opened during the editing process of the RISO Editor function.</p> <p>(Action) Close the Platen Cover gently.</p>	<p>Touch [Close].</p>
<p>Enter Print Quantity Over [N], Programed Minimum Value</p>	<p>(Symptom) You are trying to print fewer copies than previously specified on "Minimum Print Quantity".</p> <p>(Action) Enter a larger number to print, or change "Minimum Print Q'ty" on the Admin. screen. ☞ p.163</p>	<p>Specify more than the displayed number of copies and press the  key.</p>
<p>Invalid Print Drum (Cylinder) has been Selected Change Drum (Cylinder), or Reselect Drum (Cylinder) Size</p>	<p>(Symptom) You have selected a different Print Drum (Cylinder) than the one currently in place, as confirmed in the Confirm Drum (Cylinder) Type screen when it was installed.</p> <p>(Action) Select the type of Print Drum (Cylinder) currently installed. Alternatively, you can change the Print Drum (Cylinder). ☞ p.215</p>	<ul style="list-style-type: none"> • When changing a setting; In the Confirm Drum (Cylinder) Type screen, select the type of Print Drum (Cylinder) currently installed and touch [OK]. • When installing a different Print Drum (Cylinder); Pull out the Print Drum (Cylinder) and replace with the correct one. <p>When the Print Drum (Cylinder) is re-installed, the Warning Message will clear.</p>
<p>!! Multi-Up is Not Available with This Paper Size !! Replace with Proper Paper of Standard Size</p>	<p>(Symptom) Multi-up functions cannot be used when custom-sized paper is in the Paper Feed Tray.</p> <p>(Action) Load standard-sized paper in the Paper Feed Tray.</p>	<p>Touch [Close]. (Alternatively, press the  key or the  key to clear.)</p>
<p>!! No Auto Reproduction Size Selection with This Combination of Original and Printing Paper !! Select Size Manually</p>	<p>(Symptom) Auto Reproduction Size is less than 50% or more than 200%.</p> <p>(Action) Modify the reproduction size.</p>	<ul style="list-style-type: none"> • When changing the "Size" setting; Touch [Size Setting]. • When stopping the print job; Touch [Cancel]. (Alternatively, press the  key or the  key to clear.)
<p>!! No Auto Reproduction with This Original and Printing Paper !! Select Size Manually</p>	<p>(Symptom) Auto reproduction is not available because the size of the original could not be detected.</p> <p>(Action) Set the reproduction-size manually.</p>	<ul style="list-style-type: none"> • When changing the "Size" setting; Touch [Size Setting]. • When stopping the print job; Touch [Cancel]. (Alternatively, press the  key or the  key to clear.)

Troubleshooting

Message	Symptom/Action	How to Clear a Pop-Up Message
No Master on Print Drum (Cylinder) Make a New Master	(Symptom) You are attempting to print, but there is no master on the Print Drum (Cylinder). (Action) Set the original and create a master.	Touch [Close] . Important!: • Do not leave the Print Drum (Cylinder) without a master. This dries out the drum (cylinder) and causes damage. You must either create a master or perform a “Confidential” operation to wrap a master around the Print Drum (Cylinder).
Original Size Exceeds Limitation of Multi-Up Specify Original Size	(Symptom) “Multi-Up” is not available for the original size. (Action) Specify the original size. p.69	• When changing the “Original Size” setting; Touch [Original Size] . • When resuming the print job; Touch [Continue] . (Alternatively, press the  key to print.) • When stopping the print job; Touch [Cancel] . (Alternatively, press the  key or the  key to clear.)
Original Undetected Reset Original	(Symptom) The machine failed to detect the original document. The original document may not be placed. (Action) Re-position the original.	Re-position the original to clear the Pop-Up Message. • When resuming the print job; Touch [Continue] . (Alternatively, press the  key to print.) • When stopping the print job; Touch [Cancel] . (Alternatively, press the  key or the  key to clear.)
Page Format is Larger than Paper Size !! Possible Ink Smudges on Prints !!	(Symptom) The printing paper is smaller than the Master. (Action) Use a correct size printer paper.	• When printing from the machine; Touch [Continue] . (You can also print by pressing the  key.) • When stopping the print job; Touch [Cancel] . (You can also stop by pressing the  key or the  key.)
Page Format is Larger than Paper Size !! Possible Ink Smudges on Prints !! (Continue->PROOF Key)	(Symptom) The printing paper is smaller than the Master. (Action) Use a correct size printer paper.	• When printing from the machine; Press the  key. • When stopping the print job; Touch [Cancel] . (You can also stop by pressing the  key or the  key.)
Please inform this message to your administrator Due date for ID Counter Report Due date for ID counter report	(Symptom) Due date for ID Counter Report. (Action) Report to your administrator. p.151	Touch [Close] . (Alternatively, press the  key or the  key to clear.)

Message	Symptom/Action	How to Clear a Pop-Up Message
Processing Print Data from PC This Function is Not Available while Processing Current Data	(Symptom) The machine is receiving the document data from the computer. While the data is being transmitted, Scan mode is disabled. (Action) Initiate the Print job after the transmission is complete, or print from the machine.	Touch [Close] . (Alternatively, press the  key or the  key to clear.)
Reached to the limit count Contact the administrator	(Symptom) The upper limit for master-making/printing set by the administrator was reached. (Action) Contact your Administrator.	Touch [Close] . (Alternatively, press the  key or the  key to clear.)
! Scanning is Not Possible ! External CI is not Connected or Processing Connection Check Cable Connection	(Symptom) The scanning function is unavailable due to a lost connection with an external controller or because connection processing has not finished. (Action) Check the connection with the external controller.	Touch [Close] . (Alternatively, press the  key or the  key to clear.)
Set Original and Press Start Key Re-scanning will be Started to Add Image Processing	(Symptom) No original is set on the machine to rescan for image processing by the RISO Editor. (Action) Set the original and scan again.	Touch [Close] . (Alternatively, press the  key or the  key to clear.)
Starting Up Network Card Please Wait a Moment	(Symptom) RISO Network Card (Option) is starting up. (Action) Please wait a moment. Alternatively, print from the machine.	Touch [Close] . (Alternatively, press the  key or the  key to clear.)
!! The Data Storage Area has Become Full !! Clear Old Storage Data	(Symptom) Insufficient free area on the Document Storage Card. (Action) Check the storage data and delete unnecessary jobs.	Touch [Close] . (Alternatively, press the  key or the  key to clear.) • For checking the storage memory Touch [Storage Memory] .

Troubleshooting

Message	Symptom/Action	How to Clear a Pop-Up Message
!! The Number of Storage Data has Become Full !! Clear Old Storage Data in the Selected Folder	(Symptom) The selected folder is full. (Action) Check the folder and delete unnecessary data. Or, select another folder.	Touch [Close] . (Alternatively, press the  key or the  key to clear.) • For checking the storage memory Touch [Storage Memory] .
The file size is too large to store on USB Flash Drive Change the USB Flash Drive or delete some files to make spaces	(Symptom) Insufficient free area on the USB Flash Drive. (Action) Check the USB Flash Drive data and delete unnecessary jobs.	Touch [Close] . (Alternatively, press the  key or the  key to clear.) • For checking the USB Flash Drive data Touch [USB Job List] .
!!The Print Drum (Cylinder) Type has been Changed!! Select the Current Print Drum (Cylinder) Type	(Symptom) A different type of Print Drum (Cylinder) has been installed. (Action) Select the type of Print Drum (Cylinder) currently installed. Alternatively, change back to the same type of Print Drum (Cylinder) as before. p.215	• When changing a setting; In the Confirm Drum (Cylinder) Type screen, select the type of Print Drum (Cylinder) currently installed and touch [OK] . • When installing a different Print Drum (Cylinder); Pull out the Print Drum (Cylinder) and replace with the same one as before. When the Print Drum (Cylinder) is re-installed, the Warning Message will clear.
!! Unmatched Paper Size !! Interposal Paper is Smaller than Printing Paper Check Interposal Paper Size	(Symptom) Interposal Papers are smaller than paper size. (Action) Load Interposal Papers of appropriate size in the tray.	Touch [Close] . (Alternatively, press the  key or the  key to clear.)
!! Unmatched Size-- Current Page and Printing Paper !! Check Paper Size	(Symptom) The original data sent from the computer does not match the print paper size. (Action) Check the print paper size and change paper or size as needed.	• When resuming the print job; Touch [Continue] . (Alternatively, press the  key to print.) • When stopping the print job; Touch [Cancel] . (Alternatively, press the  key or the  key to clear.)

Consumable Information Screen

In order to assure optimum printing, the machine acquires information from the consumables. If acquired matching information is not proper, the Consumable Information Screen is shown. Enter appropriate values.

The **i** icon on the Info Button will be grayed-out when this occurs.

☞ p.207

Note:

- Entering an inappropriate value does not affect usual operations but may result in bad print quality.
- When you perform the following operations, the values set on the “Consumables Information Input Wizard” screen disappears and thus you need to enter the values again.
 - After the power switch is set to **O** (OFF), the switch is set to **I** (ON) again
 - After the machine is placed into the Sleep status.
 - After the **WAKE-UP** key is pressed

Ink Information Input Screen

This screen pops up when data could not be obtained from the Ink Cartridge.



Touch **[OK]** and enter values as shown below.

Screen Display	Description	Values
	[H1] Ink Color (Colour) Setting Select the same color (colour) as the Print Drum (Cylinder) currently in use.	1: Black 2: Color (Colour)

Troubleshooting

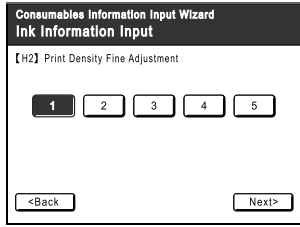
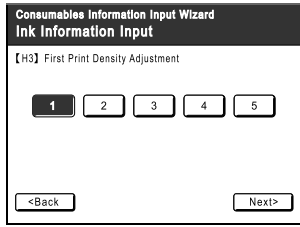
Screen Display	Description	Values
	<p>[H2] Print Density Fine Adjustment Select a Print Density level to match the ink to fine-tune print result.</p>	1 (Light) - 5 (Dark)
	<p>[H3] First Print Density Adjustment Select a Print Density level of the first print to match the ink. This can be selected independent of [H2] Print Density Fine Adjustment setting.</p>	1 (Light) - 5 (Dark)

A confirmation screen displays when done.

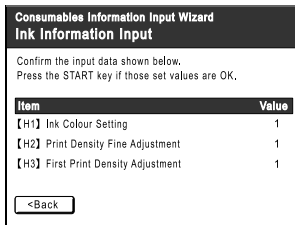

Press the  key to approve selection.
Returns to the Basic Screen.

Note:

- Master Information Input screen may also display. If so, enter Master Information as well.
p.240

Master Information Input Screen

This screen pops up when data could not be obtained from the Master Roll.
Touch **[OK]** and enter values as shown below.

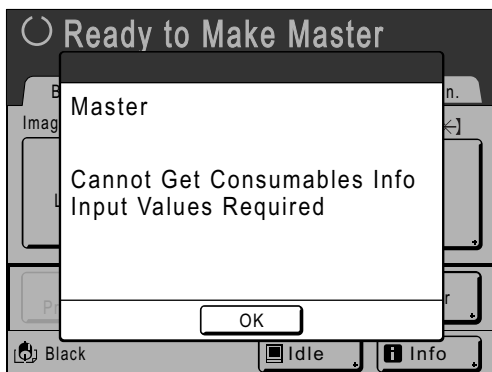

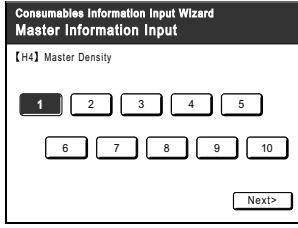
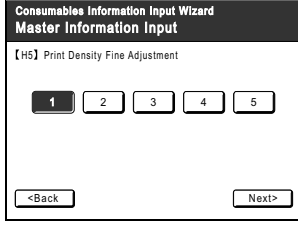
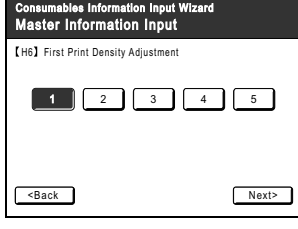
Screen Display	Description	Values
	<p>[H4] Master Density Select the standard density to be applied during creation of the master.</p>	1 (Light) - 10 (Dark)
	<p>[H5] Print Density Fine Adjustment Select a Print Density level to match the master to fine-tune print result.</p>	1 (Light) - 5 (Dark)
	<p>[H6] First Print Density Adjustment Select a Print Density level of the first print to match the master. This can be selected independent of [H5] Print Density Fine Adjustment.</p>	1 (Light) - 5 (Dark)

A confirmation screen displays when done.

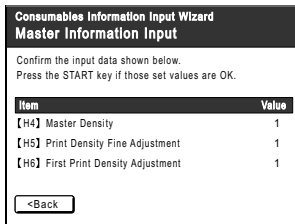











Press the  key to approve selection.
Returns to the Basic Screen.

Troubleshooting

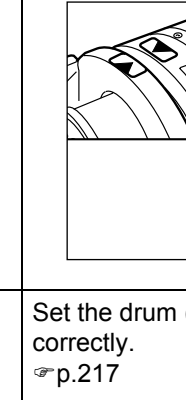
Troubleshooting



If you run into a problem, consult the following chart first to find answers before calling for a repair.

Problem	Possible Cause	Action
The machine does not start up when the power switch is pressed.	You may have pressed the power switch while the machine was in the Sleep Mode.	Try pressing the power switch again. Before pressing the power switch, you may want to find out whether the machine is indeed in the Sleep Mode, by checking the  indicator on the Control Panel. If the  key is lit, the machine is in sleep mode. Press the  key to end sleep mode and to activate the machine.
	Power has been disconnected.	<ul style="list-style-type: none"> • Check the power cord for proper connection to both the machine and the power outlet. • Check the power breaker.
The front cover is closed, but the error message still does not clear.	The Front Cover has not been firmly closed.	Completely close the Front Cover. The magnetic latch should properly engage.
The Paper Feed Tray cannot be closed.	The Feed Paper Tray Guides have not been widened up to the limit.	Turn the power on and lower the Paper Feed Tray to the bottom. Set the Feed Tray Paper Guide Lock Lever to  , widen the Feed Tray Paper Guides up to the limit, and close the Paper Feed Tray. ☞ p.32
	The power was turned off before the Paper Feed Tray was lowered to the bottom.	
The Print Drum (Cylinder) cannot be placed into position.	The Print Drum (Cylinder) was stopped at an inappropriate position after rotation.	After manually rotating the drum (cylinder), make sure that the  mark and the  mark meet as shown. 
	The Print Drum (Cylinder) has not been correctly set to the guide.	Set the drum (cylinder) to the guide correctly. ☞ p.217



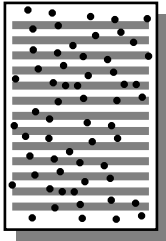

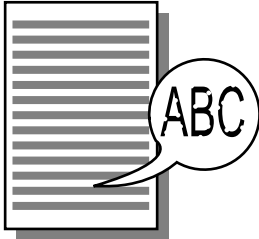
Problem	Possible Cause	Action
<p>An error indication does not disappear even though consumables (ink, master roll) are set.</p>	<p>The consumables (ink, master roll) have not been correctly set.</p>	<p>After inserting the Ink Cartridge, turn it clockwise () to lock. Or set the Ink Cartridge again. ☞ p.211</p>
		<p>Set a master roll so that the  mark comes to the left, and set the Master Making Unit. ☞ p.208</p>
	<p>The Ink Cartridge does not contain ink information.</p>	<p>Do not remove the label attached on the Ink Cartridge outlet section. If you did so, set a new Ink Cartridge. ☞ p.211</p>
	<p>The master roll does not contain master information.</p>	<p>Do not remove the  section from the master core. If you did so, set a new master roll. ☞ p.208</p>
<p>The Master Disposal Box cannot be removed.</p>	<p>The “Protect” setting is ON.</p>	<p>If the “Protect” setting is ON, the Master Disposal Box cannot usually be removed. ☞ p.174</p>
	<p>The Master Disposal Box lever is locked.</p>	<p>Slide the Master Disposal Box lever to the right to unlock. If the Master Disposal Box is padlocked, contact the administrator to release the padlock. ☞ p.213</p>
<p>There is no image on copies.</p>	<p>The original is placed face up.</p>	<p>Place the original face down. (This is also true for the ADF unit (Option))</p>
	<p>The master is installed with the incorrect side out.</p>	<p>Reinstall the Master Roll with correctly. ☞ p.208</p>
<p>Some areas are missing in the printed copy.</p> 	<p>The Glass Platen (and/or the ADF Scanner Glass) is not clean.</p>	<p>Clean the Glass Platen (and/or the ADF Scanner Glass). ☞ p.221</p>
	<p>A foreign object may exist on the master.</p>	<p>Pull out the Print Drum (Cylinder) and check if any object exists on the master. If a foreign object exists between the master and the drum (cylinder), remove the master. Then set the drum (cylinder) and perform the master-making operation again.</p>
	<ul style="list-style-type: none"> • The paper size placed on the Paper Feed Tray was not the same as the size of the original at the time of the master-making process. • The Feed Tray Paper Guides were not fit to the width of paper at the time of the master-making process. 	<p>A master is made according to the size of paper placed on the Paper Feed Tray; namely the width of the Feed Tray Paper Guides and the length of paper. If the size of paper placed on the tray is smaller than the size of the original, a master is not made for the entire original. Set the same size of paper on the tray as the original and perform the master-making operation.</p>

Troubleshooting

Problem	Possible Cause	Action
<p>Vertical blank lines are found on printed copies.</p> 	<p>The Thermal Print Head of the Master Making Unit or the Scanner Glass of ADF unit (Option) has been stained with dirt, white-out, etc.</p>	<p>Gently wipe the Thermal Print Head or Scanner Glass with a soft cloth. ☞ p.221</p>
<p>The unwanted background of an original is picked up on copies.</p> 	<p>If newspaper or colored (coloured) paper is used as an original, the background is picked up on copies.</p>	<p>Lighten the "Contrast" and create a new master. ☞ p.58</p>
<p>Dirt is found on printed copies.</p>	<p>The Glass Platen (and/or the ADF Scanner Glass) is not clean.</p>	<p>Clean the Glass Platen (and/or the ADF Scanner Glass). ☞ p.221</p>
<p>The edges of printed copies are smudged with ink.</p>	<p>Larger size of paper than the original was placed on the Paper Feed Tray at the time of the master-making process.</p>	<p>Because a master was made according to a larger size than the original, the edges of the original were processed as shadows. Set the same size of paper as the original and perform the master-making operation again. Or attach tape as described below to solve the problem.</p>
	<p>Did you use [Max. Scan] setting when making the master?</p>	
	<p>When printing thick paper such as cards, corners of the paper contacted and damaged the master.</p>	<p>Make another master and print with the new master. Or pull out the Print Drum (Cylinder) and attach cellophane tape to the damaged section on the master. However, if attached with cellophane tape, a master may not be properly sent to the Master Disposal Box.</p>

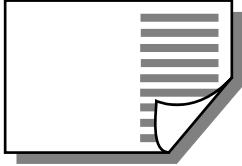
Problem	Possible Cause	Action
<p>The back of the printed paper is smudged with ink</p> 	<p>The Pressure Roller has been stained with ink.</p>	<p>Remove the Print Drum (Cylinder) and clean the Pressure Roller. ☞ p.222 If the print position is outside the print paper, this may cause the Pressure Roller to be stained with ink. Be careful when changing the size of print paper or shifting the print position.</p>
	<p>The Feed Tray Paper Guides were not fit to the width of paper at the time of the master-making process.</p>	<p>Adjust the Feed Tray Paper Guides to the width of the paper. If the Feed Tray Paper Guides are set wider than the width of the paper, a master will become wider than necessary. ☞ p.32</p>
	<p>Are you using a paper that does not efficiently absorb ink?</p>	<p>The ink did not dry fast enough, marking onto the reverse side of the next paper. Either change the paper or try "Ink Saving" or "Interval" features. ☞ p.68 ☞ p.97</p>
<p>Printed images are faint. Printed texts are blurred.</p> 	<p>If the machine is not used for an extended period of time, ink on the surface of the Print Drum (Cylinder) may dry. This results in faint or blurred printing just after printing is started.</p>	<p>The ink on the Print Drum (Cylinder) will dry when the machine is not in use for an extended period. Printing with dried ink will produce light or faded copies. Press the  key and make several copies before making copies to be actually used. Or use the "Idling Action". ☞ p.143</p>
	<p>Faint originals result in faint images.</p>	<p>Increase the scanning level and perform the master-making operation again. ☞ p.58 For originals written with a pencil, select the Pencil mode. ☞ p.56</p>
	<p>If the temperature is low (below 15°C (59°F)) in a place where the machine is installed or Ink Cartridges are stored, ink does not flow smoothly.</p>	<p>Use the machine after keeping it at room temperature for a while. ☞ p.11</p>
	<p>The Ink Saving mode has been set.</p>	<p>With the "Ink Saving" mode selected, the ink on printed copies is fainter than usual. ☞ p.68</p>

Troubleshooting

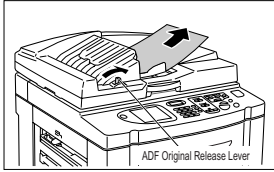
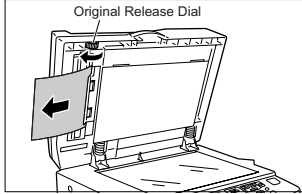

Problem	Possible Cause	Action
<p>Multi-up did not function. There is nothing printed on one side.</p> 	<p>Did you place the second original in time after the beep, while the message "Place Another Original and Press Start Key" was showing?</p>	<p>When you print using "Multi-Up", the machine will beep during the Multi-Up Interval. Place the second original during that interval. If the machine starts scanning for the second time without a beep, even when you are scanning from the Glass Platen, you will need to adjust "Multi-Up Interval" settings on the Admin. screen. ☞ p.161</p>
	<p>Did you accidentally press the  key while the original was being scanned?</p>	<p>The print operation will stop if the  key is pressed while scanning is in progress. Do not press the  key until all originals have been scanned.</p>
<p>The left and right print positions have been shifted.</p>	<p>The left and right print positions have not been adjusted for the center.</p>	<p>The Paper Feed Tray is equipped with the Horizontal Print Position Adjustment Dial. Lower the tray, adjust the position, and then perform proof copy to check the position. ☞ p.94</p>
<p>Paper sticks to the surface of the Print Drum (Cylinder).</p>	<p>The margin at the top of the original or print is too small.</p>	<p>The margin of the original (top of the print in the paper output direction) must be 5 mm ($\frac{3}{16}$") at least. Lower the vertical print position. If this adjustment is impossible, reproduce an original with enough margin and perform the master-making operation again. ☞ p.59</p>
	<p>The print paper is inappropriate.</p>	<p>Use the recommended paper. ☞ p.15</p>
	<p>The original has a solid black portion at its top.</p>	<p>If an original has a solid black portion at the top, printed copies may not properly output. Replace the original in the reverse direction and restart the master-making process.</p>
<p>Printed and curled copies are output.</p>	<p>The print paper is loaded at a horizontal grain direction.</p>	<p>Load print paper with a vertical grain direction.</p>
<p>Paper gets jammed in the ADF unit (Option).</p>	<p>There is any paper caught in the ADF unit (Option).</p>	<p>Pull the ADF Original Release Lever to the right or turn the Release Original Dial and remove the jammed paper.</p>  

Problem	Possible Cause	Action
Printed copies are not neatly aligned in the Paper Receiving Tray.	The positions of the Receiving Tray Paper Guides and the Paper Stopper are inappropriate.	Adjust the Receiving Tray Paper Guides and the Paper Stopper to the size of paper. For thick paper, slightly widen them as necessary. If you have adjusted the horizontal position on the Paper Feed Tray, shift the Receiving Tray Paper Guides in the same direction. ☞ p.35
	The positions of the Paper Jumping Wings are inappropriate.	Position the Paper Jumping Wings according to the size and thickness of paper. ☞ p.98
	The Paper Arrangers are not properly set.	Set the Paper Arrangers properly. ☞ p.35
	The Paper Feed Pressure Adjustment Lever is positioned incorrectly.	If the Paper Feed Pressure Adjustment Lever is set to "CARD (☒)", printed copies may not be correctly aligned when using standard paper. Set the Paper Feed Pressure Adjustment Lever to "NORMAL (☒)". ☞ p.33
Paper goes over the receiving tray stopper.	---	<p>Follow the steps to level the receiving tray as follows:</p> <ol style="list-style-type: none"> 1) Fold the Receiving Tray Paper Guides/Stopper. 2) Lift up the sides of the receiving tray with both hands, and move the receiving tray shaft to the position B. Position A is recommended in most cases. <div data-bbox="1226 1462 1499 1786" style="text-align: center;"> </div> <p>A: Ordinary position B: Move to this position when paper goes over the tray.</p>

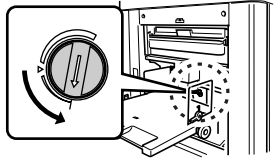
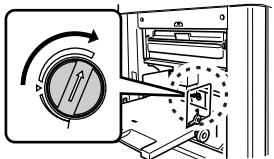
Troubleshooting

Problem	Possible Cause	Action
Paper is not smoothly fed from the Paper Feed Tray. (skipped paper, or multiple-sheet feeding)	The print paper is inappropriate.	Use paper that falls within the recommended range. ☞ p.15
	The position of the Paper Feed Pressure Adjustment Lever was inappropriate.	When using thick or slippery paper, set the Paper Feed Pressure Adjustment Lever to CARD (). ☞ p.33
	The angle of the Stripper Plate is inappropriate.	Turn the Stripper Plate Angle Adjustment dial as follows; <ul style="list-style-type: none"> • When the feeding skips Turn the dial to the left.  <ul style="list-style-type: none"> • When multiple sheets are fed Turn the dial to the right.  <p>Important!:</p> <ul style="list-style-type: none"> • Before making the adjustment, be sure to remove all paper from the Paper Feed Tray and confirm that the tray has lowered to the bottom.
	The Paper Feed Adjustment on the Functions screen is not properly set.	Adjust the “Paper Feed Adj.”. Contact your dealer (or authorized service representative) for details on making the adjustment.
The back of the printed card is peeling, or the leading edge gets wrinkled.	The angle of the Stripper Plate is in appropriate	Turn the Stripper Plate Angle Adjustment Dial to adjust the angle.
An error message displays even though there is no paper jam.	Is the lifted paper getting ejected at the second rotation of the Print Drum (Cylinder)?	Check the printed copy, and if the top margin is less than 5 mm ($3/16$ "), slightly lower Print Position.
	Is sunlight directly hitting the machine?	The sensor is affected by direct sunlight. Install shades or curtains, or move the machine out of direct sunlight.

Troubleshooting

Problem	Possible Cause	Action
When printing a multiple page computer file, the machine repeats the master-making process one page at a time.	Is "Collate" option selected in the Printer Driver?	Delete the current print job. Deselect "Collate", and resend the data to the machine. See p.46 , step 3. p.52
The computer sent the file, but it was not received by the machine.	Is the Admin. screen currently showing on the display?	Touch  and switch to the Basic Screen from the Admin. screen.
The  key is blinking.	Received data is waiting for output?	Press the  key and proceed to print.

Appendix

Optional Accessories

A variety of optional accessories are available to enhance the capabilities of the machine. For details about the optional accessories, see your dealer (or authorized service representative).

◆ Auto Document Feeder AF-VI

Feed up to 50 sheets of originals automatically.

◆ Color Drum (Cylinder)

Simply change the Drum (Cylinder) to print in multiple colors (colours). (Case included)

◆ A4 (Letter) Drum (Cylinder) W

A special drum (cylinder) for A4 or Letter size landscape paper. (Case included)

◆ Wide Stacking Tray

This unit can take paper up to 340 mm × 555 mm (13³/₈" × 21²⁷/₃₂") in size.

◆ Key Card Counter

With a single button press, shows the numbers of printed copies and consumed masters within a given period of time. This can help you manage costs.

◆ Job Separator

With the Programed Printing function, allows the machine to print and sort into groups separated by tape.

◆ Document Storage Card DM-128CF / Document Storage Card DM-512CF

A Storage Card for using the Storage Memory function.

◆ Card Feed kit

This unit allows you to feed thicker paper such as cards.

◆ Envelope Feed Kit

This unit allows you to feed envelopes.

◆ Stand

◆ Ink/Master Holder

A rack kit for storing supply such as ink and masters.

◆ RISO Network Card

Use to directly connect the machine to the network.

This comes with the RISO-MONITOR software that allows you to check the status of the machine from computers.

◆ RISO Controller IS300

A custom controller enabling the machine to be used as a network-connected PostScript 3 printer.

Specifications

RISO EZ591

Master-making/printing methods	High-speed digital master-making/full automatic stencil printing
Original Type	Book (10 kg (22 lb) or less), sheet
Original Size (max./min.)	When using the Glass Platen : 50 mm × 90 mm (1 ³¹ / ₃₂ " × 3 ⁹ / ₁₆ ") - 310 mm × 432 mm (12 ³ / ₁₆ " × 17") When using the Auto Document Feeder AF-VI : 100 mm × 148 mm (3 ¹⁵ / ₁₆ " × 5 ²⁷ / ₃₂ ") - 310 mm × 432 mm (12 ³ / ₁₆ " × 17")
Original Paper Weight	When using the Glass Platen : 10 kg (22 lb) or less When using the Auto Document Feeder AF-VI : 50 g/m ² (13-lb bond) - 128 g/m ² (34-lb bond)
Print Paper Size (max./min.)	100 mm × 148 mm (3 ¹⁵ / ₁₆ " × 5 ²⁷ / ₃₂ ") - 310 mm × 432 mm (12 ³ / ₁₆ " × 17")
Paper Supply Capacity	1000 sheets (64 g/m ² (17-lb bond))
Print Paper Weight	46 g/m ² (12-lb bond) - 210 g/m ² (110-lb index)
Image Processing mode	Line, Photo (Standard/Portrait/Group), Duo (Line/Photo/Shadow off), Pencil (Darker/Lighter)
Master-making Time	Approx. 20 seconds (for A4/landscape/100% reproduction ratio)
Printing Area (max.)	291 mm × 425 mm (11 ⁷ / ₁₆ " × 16 ³ / ₄ ")
Print Reproduction Ratio	Zoom : 50 - 200% Standard reproduction ratio (enlargement) : 200%, 154%, 129%, 121% Standard reproduction ratio (reduction) : 78%, 65%, 61%, 50% Margin+ : 90 - 99 %
Print Speed	Approx. 60 - 130 pages per minute (five steps variable)
Print Position Adjustment	Vertical : ±15 mm (± ¹⁹ / ₃₂ ") Horizontal : ±10 mm (± ³ / ₈ ")
Ink Supply	Full automatic (1000 ml per cartridge)
Master Supply/Disposal	Full automatic (approx. 215 sheets per roll)
Master Disposal Capacity	100 sheets
User Interface	LCD Touch Panel with Progress Arrow indicators, front-side operation
Optional Accessories	Auto Document Feeder AF-VI, Color Drum (Cylinder), A4 (Letter) Drum (Cylinder) W, Wide Stacking Tray, Key Card Counter, Job Separator, Document Storage Card, Card Feed kit, Envelope Feed Kit, Stand, Ink/Master Holder, RISO Network Card
Power Source	EZ591U : 100-120/220-240V~, 50-60Hz, 3.4A/1.6A
Dimensions	When in use : 1415 mm(W) × 655 mm(D) × 665 mm(H) (55 ²³ / ₃₂ "(W) × 25 ²⁵ / ₃₂ "(D) × 26 ³ / ₁₆ "(H)) When in storage : 780 mm(W) × 655 mm(D) × 665 mm(H) (30 ²³ / ₃₂ "(W) × 25 ²⁵ / ₃₂ "(D) × 26 ³ / ₁₆ "(H))
Weight	Approx. 103 kg (227 lb)
Safety Standard	IEC-60950-1 compliant, Indoor, pollution degree 2*1, At altitudes of 2000m or lower

Note:

- Please note that due to improvements and changes to the machine, some images and explanations in this manual may not correspond to your machine.
- The specifications are subject to change without prior notice.

*1 The pollution degree of the usage environment due to dirt and dust in the air. Degree "2" corresponds to a general indoor environment.

Appendix

RISO EZ571

Master-making/printing methods	High-speed digital master-making/full automatic stencil printing
Original Type	Book (10 kg (22 lb) or less), sheet
Original Size (max./min.)	When using the Glass Platen : 50 mm × 90 mm (1 ³¹ / ₃₂ " × 3 ⁹ / ₁₆ ") - 310 mm × 432 mm (12 ³ / ₁₆ " × 17") When using the Auto Document Feeder AF-VI : 100 mm × 148 mm (3 ¹⁵ / ₁₆ " × 5 ²⁷ / ₃₂ ") - 310 mm × 432 mm (12 ³ / ₁₆ " × 17")
Original Paper Weight	When using the Glass Platen : 10 kg (22 lb) or less When using the Auto Document Feeder AF-VI : 50 g/m ² (13-lb bond) - 128 g/m ² (34-lb bond)
Print Paper Size (max./min.)	100 mm × 148 mm (3 ¹⁵ / ₁₆ " × 5 ²⁷ / ₃₂ ") - 310 mm × 432 mm (12 ³ / ₁₆ " × 17")
Paper Supply Capacity	1000 sheets (64 g/m ² (17-lb bond))
Print Paper Weight	46g/m ² (12-lb bond) - 210g/m ² (110-lb index)
Image Processing mode	Line, Photo (Standard/Portrait/Group), Duo (Line/Photo/Shadow off), Pencil (Darker/Lighter)
Master-making Time	Approx. 20 seconds (for A4/landscape/100% reproduction ratio)
Printing Area (max.)	291 mm × 413 mm (11 ⁷ / ₁₆ " × 16 ¹ / ₄ ")
Print Reproduction Ratio	Zoom : 50 - 200% Standard reproduction ratio (enlargement) : 163%, 141%, 122%, 116% Standard reproduction ratio (reduction) : 87%, 82%, 71%, 61% Margin+ : 90 - 99 %
Print Speed	Approx. 60 - 130 pages per minute (five steps variable)
Print Position Adjustment	Vertical : ±15 mm (± ¹⁹ / ₃₂ ") Horizontal : ±10 mm (± ³ / ₈ ")
Ink Supply	Full automatic (1000 ml per cartridge)
Master Supply/Disposal	Full automatic (approx. 220 sheets per roll)
Master Disposal Capacity	100 sheets
User Interface	LCD Touch Panel with Progress Arrow indicators, front-side operation
Optional Accessories	Auto Document Feeder AF-VI, Color Drum (Cylinder), A4 (Letter) Drum (Cylinder) W, Wide Stacking Tray, Key Card Counter, Job Separator, Document Storage Card, Card Feed kit, Envelope Feed Kit, Stand, Ink/ Master Holder, RISO Network Card
Power Source	EZ571E: 220-240V~,50-60Hz, 1.6A EZ571A (For Korea): 220V~,60Hz, 1.6A EZ571A (For Taiwan): 110V~,60Hz, 3.4A EZ571A (For other countries): 220-240V~,50-60Hz, 1.6A
Dimensions	When in use : 1415 mm(W) × 655 mm(D) × 665 mm(H) (55 ²³ / ₃₂ "(W) × 25 ²⁵ / ₃₂ "(D) × 26 ³ / ₁₆ "(H)) When in storage : 780 mm(W) × 655 mm(D) × 665 mm(H) (30 ²³ / ₃₂ "(W) × 25 ²⁵ / ₃₂ "(D) × 26 ³ / ₁₆ "(H))
Weight	Approx. 103 kg (227 lb)
Safety Standard	IEC-60950-1 compliant, Indoor, pollution degree 2*1, At altitudes of 2000m or lower

Note:

- Please note that due to improvements and changes to the machine, some images and explanations in this manual may not correspond to your machine.
- The specifications are subject to change without prior notice.

*1 The pollution degree of the usage environment due to dirt and dust in the air. Degree "2" corresponds to a general indoor environment.

RISO EZ531

Master-making/printing methods	High-speed digital master-making/full automatic stencil printing
Original Type	Book (10 kg (22 lb) or less), sheet
Original Size (max./min.)	When using the Glass Platen : 50 mm × 90 mm (1 ³¹ / ₃₂ " × 3 ⁹ / ₁₆ ") - 310 mm × 432 mm (12 ³ / ₁₆ " × 17") When using the Auto Document Feeder AF-VI : 100 mm × 148 mm (3 ¹⁵ / ₁₆ " × 5 ²⁷ / ₃₂ ") - 310 mm × 432 mm (12 ³ / ₁₆ " × 17")
Original Paper Weight	When using the Glass Platen : 10 kg (22 lb) or less When using the Auto Document Feeder AF-VI : 50 g/m ² (13-lb bond) - 128 g/m ² (34-lb bond)
Print Paper Size (max./min.)	100 mm × 148 mm (3 ¹⁵ / ₁₆ " × 5 ²⁷ / ₃₂ ") - 310 mm × 432 mm (12 ³ / ₁₆ " × 17")
Paper Supply Capacity	1000 sheets (64 g/m ² (17-lb bond))
Print Paper Weight	46g/m ² (12-lb bond) - 210g/m ² (110-lb index)
Image Processing mode	Line, Photo (Standard/Portrait/Group), Duo (Line/Photo/Shadow off), Pencil (Darker/Lighter)
Master-making Time	Approx. 20 seconds (for A4/landscape/100% reproduction ratio)
Printing Area (max.)	251 mm × 357 mm (9 ⁷ / ₈ " × 14 ¹ / ₁₆ ")
Print Reproduction Ratio	Zoom : 50 - 200% Standard reproduction ratio (enlargement) : 163%, 141%, 122%, 116% Standard reproduction ratio (reduction) : 87%, 82%, 71%, 61% Margin+ : 90 - 99 %
Print Speed	Approx. 60 - 130 pages per minute (five steps variable)
Print Position Adjustment	Vertical : ±15 mm (± ¹⁹ / ₃₂ ") Horizontal : ±10 mm (± ³ / ₈ ")
Ink Supply	Full automatic (1000 ml per cartridge)
Master Supply/Disposal	Full automatic (approx. 250 sheets per roll)
Master Disposal Capacity	100 sheets
User Interface	LCD Touch Panel with Progress Arrow indicators, front-side operation
Optional Accessories	Auto Document Feeder AF-VI, Color Drum (Cylinder), A4 (Letter) Drum (Cylinder) W, Wide Stacking Tray, Key Card Counter, Job Separator, Document Storage Card, Card Feed kit, Envelope Feed Kit, Stand, Ink/ Master Holder, RISO Network Card
Power Source	EZ531A: 220V~, 60Hz, 1.6A
Dimensions	When in use : 1415 mm(W) × 655 mm(D) × 665 mm(H) (55 ²³ / ₃₂ "(W) × 25 ²⁵ / ₃₂ "(D) × 26 ³ / ₁₆ "(H)) When in storage : 780 mm(W) × 655 mm(D) × 665 mm(H) (30 ²³ / ₃₂ "(W) × 25 ²⁵ / ₃₂ "(D) × 26 ³ / ₁₆ "(H))
Weight	Approx. 103 kg (227 lb)
Safety Standard	IEC-60950-1 compliant, Indoor, pollution degree 2*1, At altitudes of 2000m or lower

Note:

- Please note that due to improvements and changes to the machine, some images and explanations in this manual may not correspond to your machine.
- The specifications are subject to change without prior notice.

*1 The pollution degree of the usage environment due to dirt and dust in the air. Degree "2" corresponds to a general indoor environment.

Index

Symbols

* Key	22
+ Key	22
× Key	22

Numerics

2 Up	69, 70, 74
------------	------------

A

A4 (Letter) Drum (Cylinder) W	250
Adding Paper	34
ADF Original Guide	20
ADF Original Receiving Tray	20
ADF Original Release Dial	230
ADF Original Release Lever	20, 230
ADF Semi-Auto	147, 159
ADF unit	17, 20, 147, 222
Admin.	157
Admin. Screen	25
Advanced Features	106
Appendix	250
Auto	60
Auto Clear	161
Auto Document Feeder	20
Auto Document Feeder AF-VI	250
Auto Idling	42, 163
Auto Page Renewal	144, 146, 163
Auto Power-OFF	162
Auto Print	30, 54
Auto Process Mode	159
Auto Process OFF	54
Auto Sleep	162
Auto-Link Function	192
Auto-Process	45, 64
Auto-Process Indicator	64
Auto-Process Key	23, 64
Auto-process "OFF"	47

B

Base IP Address	161
Basic Process	31
Basic Screen Layout	29
Beep Sound	163
Blocked	29
Book Shadow	81
Buttons on Touch Screen	30

C

C Key	22
Cancel Job	125
Card Feed Kit	250
Center Position Indicator	94
Changing Administrator/User Registration	119
Changing Output Directions	52
Changing Special Paper Ctrl setting	103
Changing Stored Program	133

Changing the Data Order	185
Changing the Owner Name	181
Checking Remaining Consumable Amount	206
CI Select	160
Cleaning	220
Clear All	30, 52, 53
Clearing All User Counters	122
Clearing Job Memory	140
Clearing Program	132
Clearing Special Paper Ctrl setting	104
Clearing User Registration	120
Clock/Calendar	161
Closing the Paper Feed Tray	34
Closing the Paper Receiving Tray	36
Color Drum (Cylinder)	215, 250
Computer Connection	13
Confidential	141
Configurable Functions	157, 200
Connection Method	13
Connector	216
Consumable Errors	224, 227
Consumable Information Screen	239
Consumables	12, 206
Contrast	58
Contrast Adj	66
Control Panel	20, 22
Copying Stored Data	189
Counter	21
Counter Report	152
Create User	108, 162
Custom Paper Entry	160, 170
Custom-Sized Paper	63, 170, 172

D

Data Information	180
Data Order	185
Data-Map	29
Default Folder	160
Default Settings	157, 165
Density (print density)	93
Direct Access	168
Direct Access Area	29, 168
Direct Access Entry	157, 168
Direct Print	44
Disable	118
Disabling User identification Access	118
Display	20, 22, 24
Display Adjustment	158
Display Language	158
Display Priority	157
Disposing of Consumables	218
Document Storage Card	250
Dot Process	65
Duo	56
Duo (Line)	56

- Duo (Photo) 56
 Duo (Shadow off) 56
 Duplex Interval 164
 Duplex Printing 202
- E**
- ECO mode 162
 E-mail 151
 Energy Saving Mode 162
 Enlarging/reducing 75
 Enlarging/Reducing Originals 59
 Entering Master Information 240
 Entering sizes and changing names 170
 Entering the User Name 115
 Envelope Feed Kit 250
 Error 29
 Error Messages 224
 Ex. Reserve Period 142, 161
 Extended Paper 171
 External CI Info 161
- F**
- Feed Tray Ascent/Descent Button 20, 34, 95
 Feed Tray Paper Guides 20, 32
 Fixed Scan Size 160
 Flanges 209
 Folder Renaming 160
 Format 182
 Free 59, 61
 Front Cover 21
 Function and Name of Each Part 20
 Functions Area 29
 Functions Descriptions 9
 Functions Screen 25
- G**
- Gauge Cover 37
 Glass Platen 17, 20, 37, 221
 Go to Next 125
 Group 116, 123
- H**
- High/Full Management 106, 107
 Horizontal (Left/Right) Adjustment 95
 Horizontal Print Position Adjustment Dial 20, 95
 Humidity range 11
- I**
- i Information 29, 207
 Icons Used in This Manual 8
 ID Counter Report 151
 ID Print 48
 ID Print Job 183
 Idle 29
 Idling Action 143
 Image 56
 Image Processing 56, 159
- Initial Screen 24
 Ink 211, 218
 Ink Cartridge 21, 211, 218
 Ink Cartridge Cap Holder 21, 212
 Ink Handling 12
 Ink Information Input 239
 Ink Saving 68
 Ink/Master Holder 250
 Installation 10
 Installation Errors 224, 228
 Installation location 10
 Installing the Print Drum (Cylinder) 217
 Interval 97
- J**
- Job 30
 Job list display 158
 Job List Screen 48
 Job Memory 134, 135, 136, 138, 140
 Job Operation Area 30
 Job Properties Area 30
 Job Separation 159
 Job Separator 125, 250
 Jump Wing Control 98, 99, 160
- K**
- Key Card Counter 250
- L**
- Limit 117
 Line 56
 Link Basic Screen 199
 Link Info Refresh 164
 Link Mode 27
 Link Mode Function 192
 Link Properties 164, 193
 Link Scanning Mode 164
 Linked Printer 164, 192
 Linked Printer Setup List 194
 Link-Free Volume 164
 Location of Caution Label 12
 Log out Key 23
 Low/Admin tab only 106, 107
- M**
- Machine Handling 11
 Maintenance 220
 Maintenance Call 232
 Malfunctions 242
 Management Level 106, 107, 111, 162
 Margin 18, 73
 Margin+ 59, 60
 Margin-Plus Rate 161
 Master 219
 Master core 209, 218
 Master Disposal Box 20, 213
 Master Disposal Box Handle 213

Index

- Master Disposal Box Lever 213
- Master Guide Flap 21, 209
- Master Information Input 240
- Master Jam Errors 224, 225
- Master Making Unit 21, 208
- Master Making Unit Cover 21, 208
- Master Making Unit Cover Lever 208
- Master Making Unit Handle 21, 208
- Master Making Unit Release Button 21, 208
- Master Removal Hook 222, 231
- Master Replacement 208
- Master Roll 21
- Master Roll Holder 21, 209
- Master-Making Key 23
- Materials Not to Be Printed 18
- Max. Scan 90
- Maximum Printing Areas 18
- Message 224
- message area 143
- Meter Display 149
- Metric/Inch Switch 158
- Mid/ID Print Only 106, 107
- Minimum Print Q'ty 163
- MODE Key 22
- Mode Key Pattern 157
- Monthly Reminder 153
- Moving Stored Data 189
- Multi-Page Mode 124, 127
- Multiple-Original 69
- Multi-Up function 69
- Multi-Up Interval 73, 161
- Multi-Up Print 69, 70, 76
- Multi-Up Tickets 69, 72, 78
- My Counter 206
- My Direct Access 155
- N**
- Next Page 125
- Non-ID Print 184
- O**
- Online Auto-Link 164
- OP Auto Process 159
- Operation Environment 11
- Operation flow of User Management 108
- Operation Safety Guide 11
- Operational Instructions 9
- Option 250
- Optional Device Area 30
- Optional Device Errors 224, 226
- Optional Functions (Linked Printer) 199
- Orientation of Print Paper 73
- Original 17
- Original Margin 18
- Original Orientation and Print Results 70
- Original Scan Density 58
- Overlay 187
- Overlaying Stored Data 188
- Owner Name 181
- owner name 180
- P**
- P Key 22
- Page Orientation 164
- Paper 63
- Paper Arranger 21, 35, 36
- Paper Button 30
- Paper Eject Adj. 98
- Paper Ejection Adj 160
- Paper Feed Adj. 98
- Paper Feed Pressure Adjustment Lever 20, 33
- Paper Feed Tray 20, 32
- Paper Jam Errors 224, 230
- Paper Jumping Wing 21, 98
- Paper Receiving Tray 21, 35, 36
- Paper Recommendations 15
- Paper Size 197
- Paper Stopper 21, 35, 36
- Pause 29
- Pause before "Master" 46
- Pause before "Print" 47
- Pencil 56
- Pencil (Darker) 56
- Pencil (Lighter) 56
- Photo 56
- Photo Contrast 66
- Photo Gradation 67
- Photo (Group) 56
- Photo (Portrait) 56
- Photo (Standard) 56
- PIN code 107, 109, 113, 165
- PIN code Input Screen 28, 43
- Platen Cover 20
- Platen Cover Pad 20, 221
- Pop-Up Message 232
- Power connection 10
- Power Switch 21, 32
- Power-OFF Schedule 162
- Pressure Roller 222
- Preview 30, 52, 87
- Print 151
- Print Colors (Colours) 164
- Print Density 22, 93, 159
- Print Density Adjustment 93
- Print Density Adjustment Indicator 22, 93
- Print Density Adjustment Keys 22, 93
- Print Drum (Cylinder) 21, 215, 217
- Print Drum (Cylinder) Handle 21, 215
- Print Drum (Cylinder) Release Button 21, 215
- Print Drum (Cylinder) Replacement 215
- Print Key 23
- Print Paper 15

Print Paper Handling	16	Rotate	145, 150
Print Paper Setting	32	S	
Print Position	22	Safety Guide	10
Print Position Adjustment	22, 94	Saving Programs	128
Print Position Center Key	94	Saving Special Paper Ctrl	100
Print Quantity Display	22, 96	Scan Mode	27, 178
Print Quantity Keys (0 to 9 Keys)	22	Scanner Glass	222
Print Speed	22, 92, 159	Scanning Contrast	58, 159
Print Speed Adjustment	92	Selections	168
Print Speed Adjustment Indicator	22, 92	Selections Entry	157, 168
Print Speed Adjustment Keys	22, 92	Selections Screen	168
Printer Exterior	223	Selections Tab	168
Printing from Computer	30, 31, 44	Semi-Auto (Master)	54
Printing from Paper Document	29, 31, 39	Semi-Auto (Print)	54
Program	123, 128, 129, 131, 132, 133	Separation Hook	222, 231
Program Print	125, 126	Service Call Errors	224, 225
Progress Arrows	23	Setting Data Information	180
Proof	96	Setting the Group to assign	116
Proof copy	96	Setting the Management Level	111
Proof Key	23, 96	Setting the Paper Receiving Tray	35
Protect	162, 173, 174	Setting the User's Usage	117
Push Out Lever	213	Setting Up for Programed Printing	126
R		Setting Up the Monthly Reminder	153
Receiving Tray Paper Guides	21, 35, 36	Side Margin	85
Recognition and Identification System	109	Single Page Mode	123, 126
Recognition Screen	28, 43	Single-Original	69
Recognized by	107, 109, 113, 162, 165	Size and Weight Restrictions	15, 17
Registering Administrator/Users	112	Skip Page	30, 52
Reminder Date	151	Software Installation	14
Removing the Print Drum (Cylinder)	215	Special Paper Ctrl	98, 100, 102, 103, 104
Rename	115, 129	Specifications	251
Rename Group	108, 121, 162	Specifying Stored Size	182
Rename screen	130	Speed (print speed)	92
Renaming a Job Memory	136	Stabilizer	21
Renaming a Program	129	Stand	250
Renew Page	30, 52, 125, 144	Standard Ratio	59, 60
Replacing Batteries	225, 232	Start Key	23
Replacing Consumables	206	Start-Up Screen	24, 158
Replacing Paper	34	Status Area	29, 30
Reproduction Size	159	Stock Management	163
Reservation	142	Stop Key	23
Reserve Period	161	Stop Timing	45, 54
Reset Counter	108, 122, 162	Storage Memory	183
Reset Key	23	Storage Retrieve Screen	186
Retrieving a Job Memory	138	Storing Environment	16
Retrieving a Program	131	Storing Job Memory	135
Retrieving Special Paper Ctrl	102	Storing Original Data	176
Retrieving Stored Data	183	Sub Tool Bar	164
RISO Controller IS300	250	T	
RISO COPY COUNT VIEWER	14	Tab Area	29, 30
RISO Network Card	250	Temperature range	11
RISO Print	26	Text and Photo (Image Processing mode)	56
RISO Printer Driver	14	Text (Image Processing mode)	56
RISO USB PRINT MANAGER	14	The Screens and their Various Stages	24
RISO Utility Software	14		

Index

Thermal Print Head21, 221
Tips for Better Paper Feeding 16
Tone Curve67
Tool Bar Position 164
Top Margin83
Troubleshooting224, 242

U

Usage Status 149
USB Flash Drive 12, 107, 109, 113, 151, 165
USB Flash Drive Screen28, 43
USB Job List44, 49, 183
USB Job List Retrieve Screen 186
USB slot21, 49
User Counter 122
User identification access 107, 118
User Management 106, 162
User Name 115
User Registration Number (ID) 112
User's Usage 117

V

Vertical Print Position Adjustment Keys22, 94
Vertical (Up/Down) Adjustment94

W

WAKE-UP Key23, 39, 49
Warning Messages 233
White Roller 222
Wide Stacking Tray 250

Z

Zoom 59, 62

To Administrator

Canceling the Protect Setting

Cancellation of the “Protect” setting should be always done by the administrator.

Important!:

- To attach more importance to security, cut out this page, which should be stored by the administrator.

- 1 Touch [Admin.] on the Basic Screen for each mode.

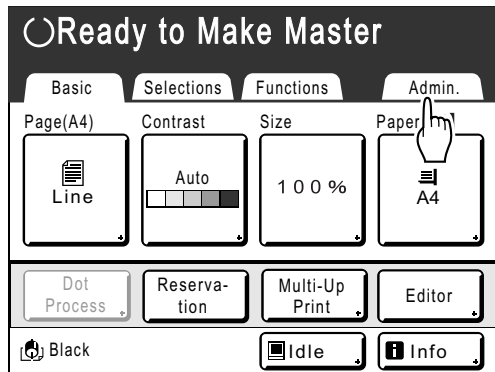

- 2 Touch [OK].



If the Recognition Screen is displayed, follow the message on the screen. See step 2 in “Customizing the Default Settings”. (p.165)

- 3 Touch [Protect].

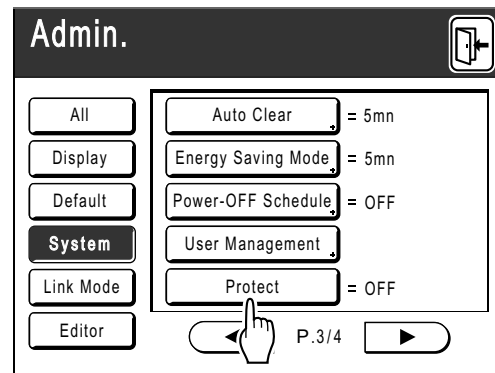

After displaying the message “Please Wait a Moment”, the protect setting is canceled.

