

ComColor Series

User's Guide

This guide describes total operation features and specifications.



Applicable Printer models

9050/9050R
7050/7050R/7010/7010R
3050/3050R/3010/3010R

050-36300-002

Options and functions vary depending on the model.

	ComColor 9050	ComColor 9050R	ComColor 7050	ComColor 7050R	ComColor 7010	ComColor 7010R	ComColor 3050	ComColor 3050R	ComColor 3010	ComColor 3010R
Maximum Print Area	314 mm × 548 mm (12 3/8" × 21 9/16")		314 mm × 548 mm (12 3/8" × 21 9/16")		310 mm × 544 mm (12 3/16" × 21 7/16")		210 mm × 544 mm (8 1/4" × 21 7/16")		210 mm × 544 mm (8 1/4" × 21 7/16")	
Printable Area (Margin)	Standard: 3 mm (1/8") Maximum: 1 mm (1/16")		Standard: 3 mm (1/8") Maximum: 1 mm (1/16")		Standard: 5 mm (3/16") Maximum: 3 mm (1/8")		Standard: 5 mm (3/16") Maximum: 3 mm (1/8")		Standard: 5 mm (3/16") Maximum: 3 mm (1/8")	
USB Port	✓*1		✓*1		✓*1		✓*1		✓*1	
Multifunction Finisher (Optional)	✓		✓		N/A		✓		N/A	
Feed Tray*2	✓		✓		N/A		✓		N/A	

✓: available

N/A: not available

*1 A USB port may be provided upon user's request. For details, please contact your service representative.

*2 [Slip sheet] and [Add cover] functions require the feed tray.

For ComColor 3050/3050R/3010/3010R

Regular size paper whose width exceeds 216 mm (8 1/2") is not displayed on the printer driver screen and the operation panel.



CAUTION

After reading this guide, keep it in handy for future reference. The "Safety Precautions" are provided in the supplemental Safety Information. Be sure to read through them prior to use.

About This Guide

Preface

Thank you for using the ComColor Series product.

This ComColor Series is an inkjet printer that is network-compatible and performs high-speed, full-color printing.

You can use the various functions of this printer to print data and monitor printer operations from a computer. And with the optional scanner, you can copy originals, save and use scanned data, and use various functions.

The following five guides are supplied with this machine.

● **Basic Guide**

This guide describes the basic printer, copy, and scanner operations and how to replace consumables. Please start by reading this guide.

● **User's Guide (this guide)**

This guide describes specifications, operations and settings of each function. Please read this guide when you want to know details about this machine.

● **Administrator's Guide**

This guide describes the machine settings to be performed by the administrator.

● **Troubleshooting Guide**

This guide describes the action to take when a paper jam or other problem occurs.

● **Safety Information**

This guide describes safety precautions and specifications.

About This Guide

- (1) No part of this guide may be reproduced in whole or in part without the permission of RISO KAGAKU CORPORATION.
- (2) The contents of this manual may undergo changes without prior notice to reflect improvements in the product.
- (3) RISO shall not be liable for any consequence of using this guide or the machine.

Trademark Credits

Microsoft and Windows are registered trademarks of Microsoft Corporation in the U.S. and/or other countries.

ColorTune is a registered trademark of Agfa-Gevaert N.V., is registered in the U.S. Patent and Trademark Office, and may be registered in other jurisdictions.

Intel and Celeron are trademarks of Intel Corporation in the United States and other countries.

FeliCa is a registered trademark of Sony Corporation.

Mifare is a registered trademark of Royal Philips Electronics.



ComColor and FORCEJET are trademarks of RISO KAGAKU CORPORATION.

 is a registered trademark of RISO KAGAKU CORPORATION in Japan and other countries.

All other product names and company names written in this guide are trademarks or registered trademarks of their respective companies.

Symbols, Notations, and Screenshots Used in This Guide

■ Symbols Used in This Guide

-  Indicates cautions that should be noted for safe use of this machine.
-  Indicates important items that should be noted or are prohibited.
-  Indicates useful information or additional information.

■ Names of Keys and Buttons

The names of hard keys on the operation panel and buttons on the touch panel screen or computer window are indicated with square brackets [].

Operation Panel

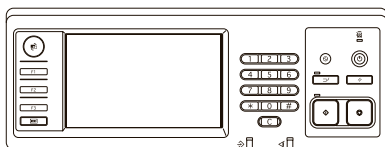

Example: Press the [STOP] key.

Touch Panel Screen

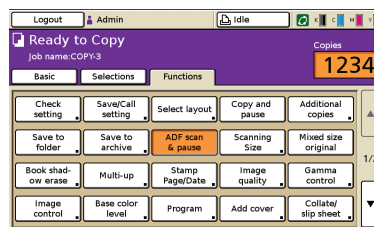

Example: Press [ADF scan & pause].

Computer Window

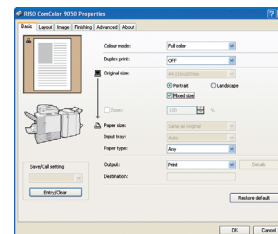

Example: Select the [Mixed size] check box.

■ Names of Optional Equipment

The following are the names of the optional equipment used in this guide. An individual name is used for each item of equipment when describing its unique features.

Name Used in This Guide	Optional Equipment
Stacking tray	Wide stacking tray RISO auto-control stacking tray

■ Illustrations Used in This Guide

The screenshots contained in this guide may vary from the actual screen display depending on the usage environment, including the connected optional equipment.

Contents

About This Guide	1
Symbols, Notations, and Screenshots Used in This Guide	2
Part Names and Functions	7
Main Unit and Optional Scanner	7
Stacking Tray (optional)	8
Finisher (optional)	9
Operation Panel	10
Touch Panel	11
Touch Panel Operations	13
Using the Touch Panel	13
Logging In	13
Entering Text	15
List of Settings for Each Mode	16
Print Preparations	22
Turning the Power On/Off	22
Loading Paper	23
Preparing the Stacking Tray (optional)	27
Chapter 1 Printer Driver	1-1
Overview of Print Operations	1-2
Printer Driver Screen	1-2
Procedure	1-3
List of Settings	1-5
Basic Settings	1-7
[Basic] Tab	1-7
[Layout] Tab	1-12
[Image] Tab	1-15
[Finishing] Tab	1-17
[Advanced] Tab	1-23
[About] Tab	1-27
Environment Settings	1-28
[Environment] Tab	1-28

Chapter 2 Copy	2-1
Overview of Copy Operations	2-2
Procedure	2-2
List of Settings	2-6
Basic Settings	2-8
Color mode	2-8
Reproduction size	2-9
Feed tray	2-9
Original	2-12
Scanning level	2-13
Duplex/Simplex	2-14
Direct Access/Selections entry	2-16
Direct Access entry	2-17
Selections entry	2-17
Copying Functions	2-18
Check setting	2-18
Save/Call setting	2-19
Select layout	2-22
Copy and pause	2-23
Additional copies	2-24
Save to folder	2-24
Save to archive	2-26
ADF scan & pause	2-27
Scanning size	2-27
Mixed size original	2-28
Book shadow erase	2-29
Multi-up	2-30
Stamp Page/Date	2-31
Image quality	2-33
Gamma control	2-34
Image control	2-35
Base color level	2-35
Program	2-36
Add cover	2-40
Collate/slip sheet	2-41
Auto-Rotate	2-43
Staple/Punch	2-43
Paper folding	2-45
Booklet	2-47
Output tray	2-49
Paper guide control	2-50
Jump wing control	2-51
Head cleaning	2-51
Front doors release	2-52
Interrupt copy	2-52

Chapter 3 Scanner	3-1
Overview of Scan Operations	3-2
Procedure	3-2
List of Settings	3-8
Basic Settings	3-9
File format	3-9
Reproduction size	3-10
Image size	3-10
Color mode	3-11
Scanning level	3-12
Duplex/Simplex	3-12
Scanning Functions	3-13
Check setting	3-13
Save/Call setting	3-13
Original	3-13
Book shadow erase	3-14
Scanning size	3-14
Mixed size original	3-14
Gamma control	3-14
Image control	3-14
Base color level	3-14
PIN code	3-15
Front doors release	3-15
Chapter 4 Printer	4-1
Overview of Printer Mode Operations	4-2
Procedure	4-2
List of Settings	4-5
Managing Jobs	4-6
[Active] Screen	4-6
[Waiting] Screen	4-7
[Finished] Screen	4-8
[Folder] Screen	4-9
Changing Finished Job and Folder Job Settings	4-11
Printer Function Settings	4-14
Online	4-14
Feed tray	4-14
Head cleaning	4-15
Paper guide control	4-15
Jump wing control	4-15
Front doors release	4-15

Chapter 5 RISO Console	5-1
Overview of the RISO Console	5-2
Starting the RISO Console	5-3
[Monitoring] Menu	5-4
[General] Screen	5-4
[System] Screen	5-5
[User] Screen	5-5
[License Info.] Screen	5-6
[Meter display] Menu	5-7
[Details] Screen	5-7
[Limit] Screen	5-7
[Report] Screen	5-8
[Printer] Menu	5-9
[Active] Screen	5-10
[Waiting] Screen	5-10
[Finished] Screen	5-11
[Folder] Screen	5-11
[Functions] Screen	5-12
[Scanner] Menu	5-13
Chapter 6 Appendix.....	6-1
Specifications	6-2
Consumables	6-11
Ink Cartridges	6-11
Index	6-13

Part Names and Functions

Main Unit and Optional Scanner

<The ComColor 9050 is shown in this illustration.>

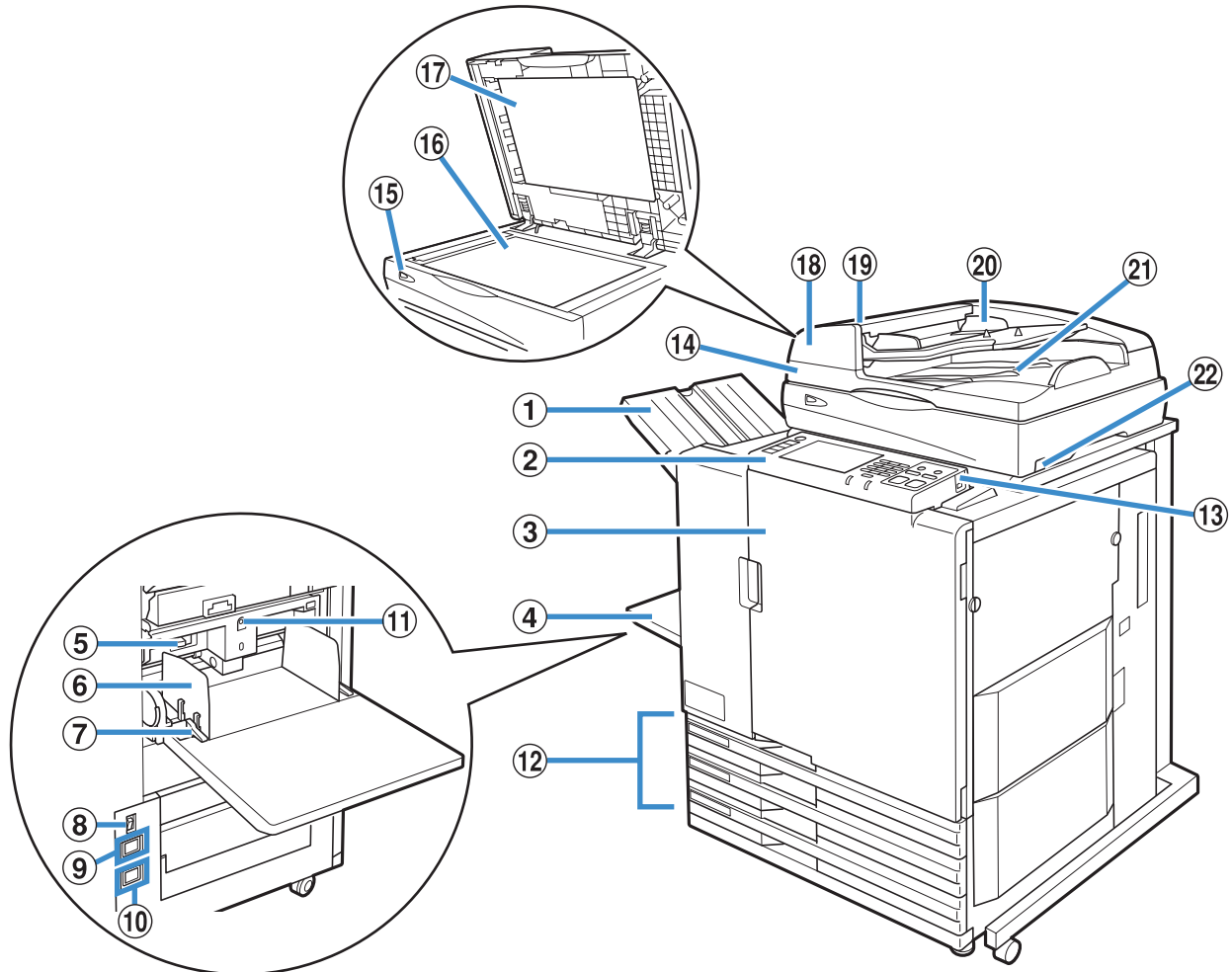

① Face Down Tray

The printouts are output face-down. When the optional face down offset tray is installed, the machine stacks each print job slightly shifted apart from one another.

② Operation Panel

Use to perform operations or settings.

③ Front Cover

Open when paper is jammed or when replacing an ink cartridge.



Normally (when there is no problems such as paper jams), this cannot be opened. When you want to open it, turn the [Front doors release] to ON.

④ Standard Tray

Load special paper (thick paper, envelopes, and so on) here. Plain paper can also be loaded.

⑤ Paper Feed Pressure Adjustment Lever

Use to adjust the paper feed pressure to suit the type in the standard tray.

⑥ Standard Tray Paper Guide

Use to prevent paper in the standard tray from becoming misaligned.

⑦ Paper Feed Guide Lever

Use to slide or fix the standard tray paper guide. Levers are located on both sides of the standard tray paper guide, in two positions.

⑧ Main Power Switch

Use to turn the main power on and off. Usually the power is left on.

⑨ Scanner Socket

Use to connect the scanner power cord.

⑩ Main Unit Socket

Use to connect the main unit power cord.

⑪ Standard Tray Descent Button

Use to move the standard tray up or down when replacing or adding paper to it.

⑫ Feed Tray

Set the paper to be used for printing here. Special paper such as thick paper cannot be set.

⑬ USB Port

Use to connect a USB flash drive to save scanner data.



Use USB flash drive compatible with Mass Storage Class and USB 1.1 or 2.0 specifications.

⑭ Scanner (Optional)

Use to copy or scan documents that are read from the platen glass or the ADF.

⑮ Scanner Lamp (green/red)

Lights up in green when the scanner is ready to be used. Flashes in green when starting up or while reading, and flashes in red when an error occurs.

⑯ Platen Glass

Set the original face down and aligned with the position of the arrow in the top left.

⑰ Original Cover

Pull down to cover the original when reading it on the platen glass.

⑱ Automatic Document Feeder (ADF)

Up to about 100 originals can be automatically fed.

⑲ ADF Original Unit Lever

Pull this lever up to open the original unit cover when originals are jammed.

⑳ ADF Original Guide

Slide to fit the width of the original.

㉑ ADF Original Output Tray

Documents that are read from the ADF are output here.

㉒ Scanner Power Switch

Use to turn the scanner power on and off. Usually the power is left on.

Stacking Tray (optional)

The RISO auto-control stacking tray and wide stacking tray are available as optional stacking trays. Printouts are ejected face-up.

- With the RISO auto-control stacking tray, the paper guides adjust automatically to fit the paper size.
- With the wide stacking tray, move the paper guides (sides and end) to match the size of the paper for printing.

<The RISO auto-control stacking tray is shown in this illustration.>

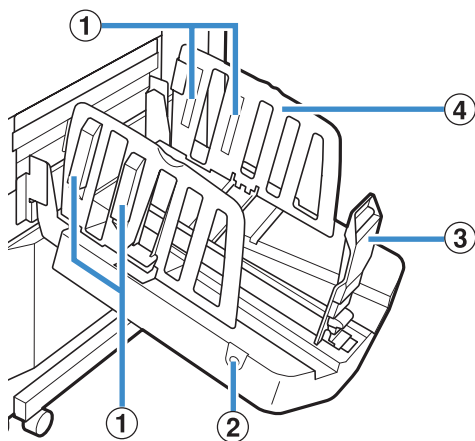

① Paper Arranger

Set to suit the paper type so that the output paper is neatly aligned.

② Paper Guides Open Button

Use to spread the paper guides apart. Operation varies depending on whether paper is present or not.

- When the machine is idle and there is no paper in the stacking tray, the guides open to the loading position.
- When the machine is idle and there is paper in the stacking tray, the paper guides spread apart, making it easy to remove the paper. The paper guides that spread apart when the button is pressed vary depending on the administrator settings.



This button is found only on the RISO auto-control stacking tray.

③ Paper Guide (end)

④ Paper Guide (side)

Use to prevent output paper in the stacking tray from becoming misaligned.

Finisher (optional)

If you connect the optional multifunction finisher, you can staple or punch the printed paper or create a booklet.

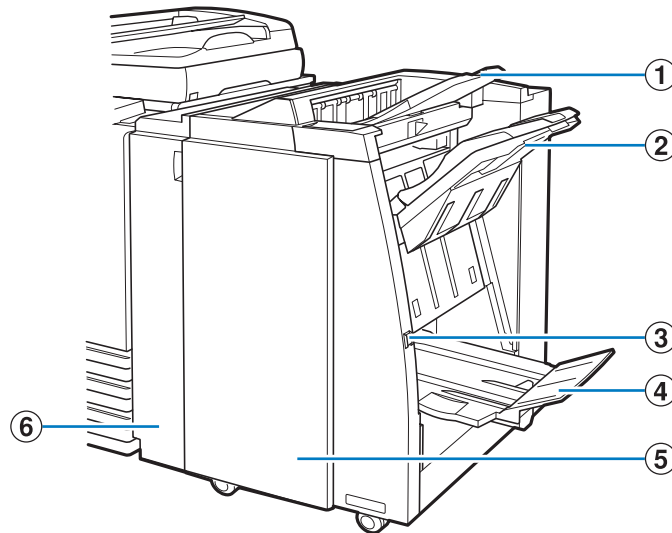

① Top Tray

The printouts are output here when punching is performed.

② Stacking Tray

The printouts are output here when the staple or offset output function is used.

③ Eject Button

Use this button to move the printouts in the booklet tray to the position where you can easily retrieve them.

④ Booklet Tray

Booklets and 2-fold printouts are output here.

⑤ Right Cover

Open to replace the staple cartridge or if paper is jammed.

⑥ Left Cover

Open to remove the jammed paper from the paper feed path between the printer and the finisher.

Operation Panel

Various operations and settings can be performed using the operation panel.

You can also identify the machine status or errors such as paper jamming from the lamp colors and whether the lamps light up or flash.

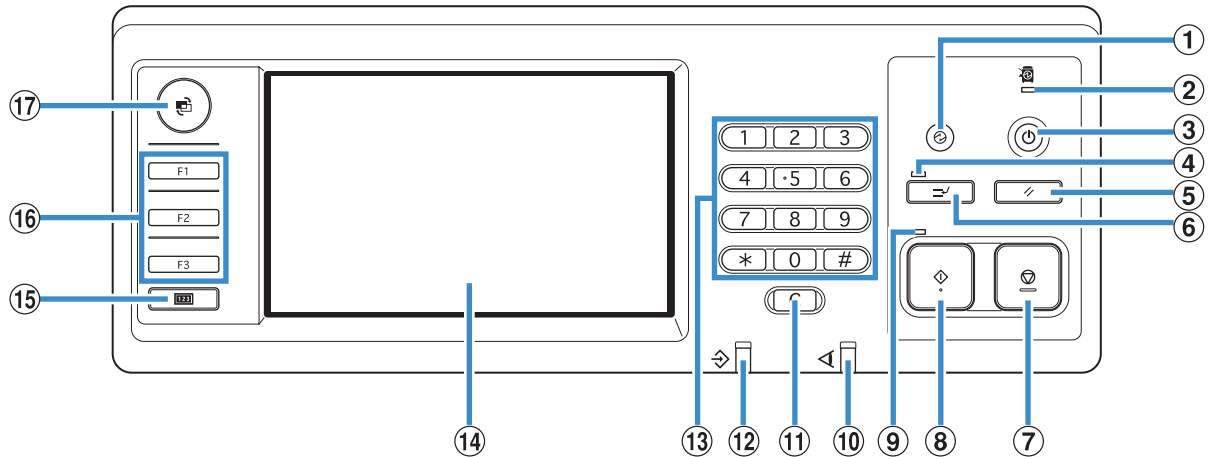

① Wake Up Key

Lights up when the machine is in the backlight OFF or sleep status.

Press to make the machine ready for operation.

② Main Power Lamp

Lights up when the main power is "ON".

③ Sub Power Key

Use to turn the power on and off. Lights up when the power is on. To switch to off, press and hold.

④ Interrupt Lamp

Lights up during copy interrupt.

⑤ RESET Key

Press to return the settings to their default values.

⑥ Interrupt Key

Press to temporarily stop the copying that is in progress and execute a different copy job.

⑦ STOP Key

Press to stop the job that is in progress.

⑧ START Key

Press to start an operation.

⑨ Start Lamp

Lights up when the START key is ready to be used.

⑩ Error Lamp

Flashes when an error occurs.

⑪ Clear Key

Press to clear letters or numbers that have been entered.

⑫ Data Receive Lamp

Flashes when data is being received.

⑬ Numeric Keys

Press to enter numbers.

⑭ Touch Panel

Use to perform operations or settings.

This panel also displays information such as error messages and confirmation messages (p. 11 "Touch Panel").

⑮ Counter Key

Press to display the total number of copy or print sheets.

⑯ Function Keys

Use as shortcut keys for moving to the mode by registering modes or functions. They are registered in the administrator settings.

⑰ MODE Key

Press to switch to the mode screen.

Touch Panel

● Mode Screen

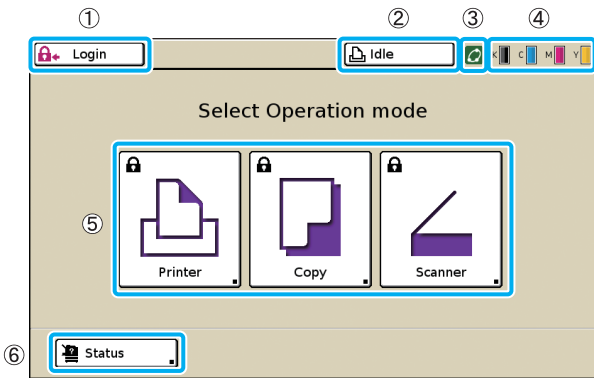

This is a screen to select the mode you want to use. Press a mode button to access that mode. On this screen, you can see the remaining amount of ink and machine status. You can access this screen anytime when pressing the MODE key on the operation panel.

The buttons displayed vary depending on the optional equipment connected and settings details.

① [Login]
Press this button to log in.

While you are logged in, this button is labeled [Logout], and the name of the current user is displayed next to the button.



② Printer Status Button
This button indicates the current machine status: Idle, Printing, Error, or Offline.

Press the button to switch to the printer mode screen.

③ FORCEJET™ Link Icon
This icon indicates whether all parts required for printing are working correctly. The icon is grayed out if accurate color management is not possible.

④ Remaining Ink Indicator
These icons indicate how much of each ink color is left. The icons flash when less than 10% of the capacity is left. Prepare a new ink cartridge of the color that flashes.

⑤ Mode Buttons
Press these buttons to access screens for each mode. Lock icons in the upper left corner of a button indicate that you must log in to access that mode.

- The mode buttons are not displayed unless the optional equipment has been connected.
- Buttons for modes that the current user is not authorized to use are grayed out.

⑥ [Status]
Press this button to check General, System, or User information.

● Mode Screens

Pressing a mode button on the mode screen will switch to that mode screen.

■ Printer Mode Screen

Manage or check print jobs (jobs stored in shared or personal folders on the machine, or jobs sent from a computer).

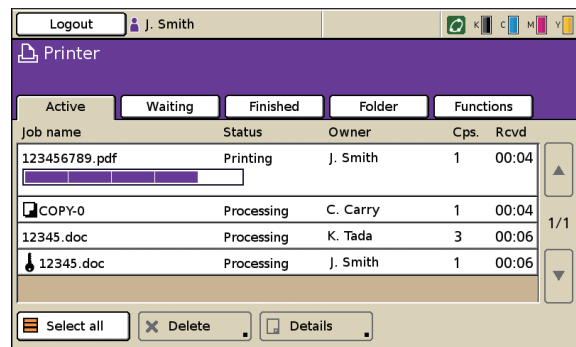

■ Copy Mode Screen (Optional)

Control copying on this screen.

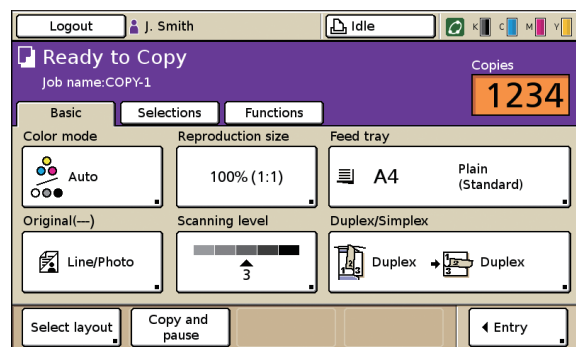

■ Scanner Mode Screen (Optional)

Control scanning on this screen.

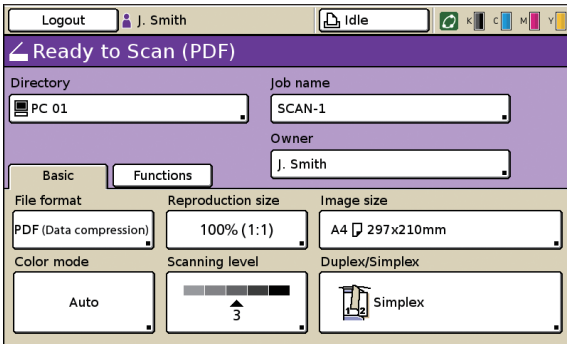

■ Status Screen

● General Screen

Enables you to check the status of the consumables, such as paper or ink.

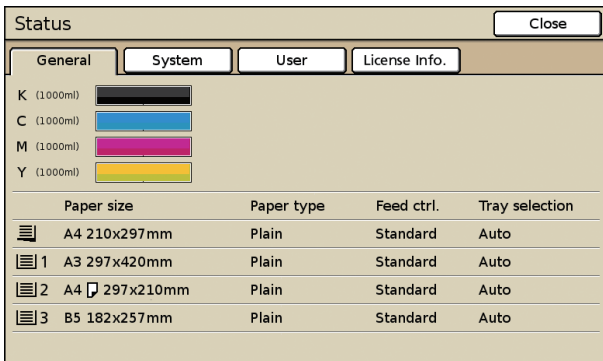

● System Screen

Enables you to check the model of the machine and other information.

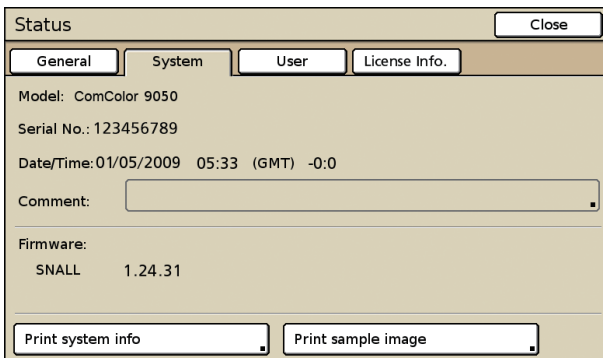

● User Screen

Enables you to check the logged in user name and group. This screen is displayed only when a user is logged in.

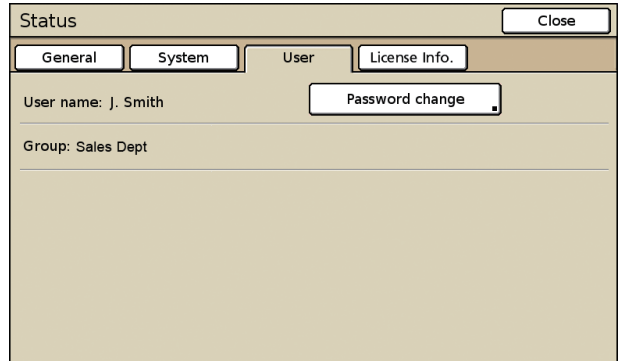

● License Info. Screen

Enables you to view information about the license of the system in the machine.

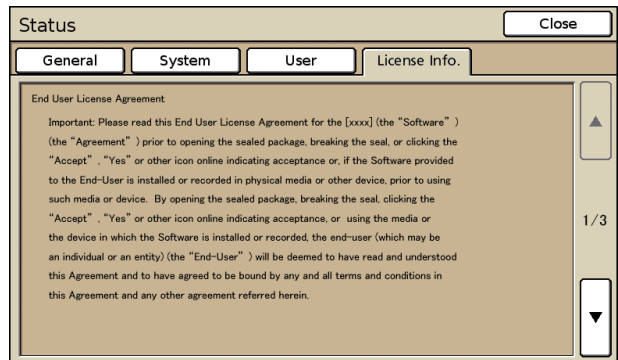

Touch Panel Operations

You can operate the machine by using the touch panel and keys on the operation panel. To use a button on the touch panel, touch it with your finger. That action is referred to as "press" in step-by-step instructions in this guide.

Using the Touch Panel

Buttons

To select a button on the touch panel, press the button.

"■" displayed in the lower right corner of a button indicates that pressing the button will display another screen to complete the settings.



If "■" is not displayed, the button activates or deactivates the function each time it is pressed. Active functions are displayed in orange.

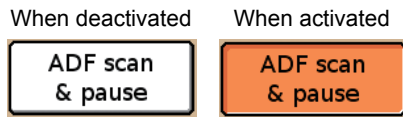

Buttons that are not available under the current conditions are grayed out. You can use these buttons when the required conditions are met.

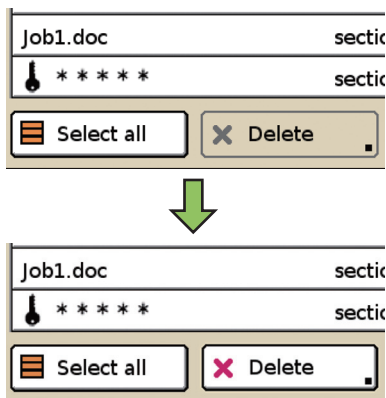

Confirming or Canceling Settings

When [OK] is displayed on a screen, you must press [OK] to save the settings. If you do not press [OK], the settings may be discarded.

To cancel the settings you have completed, press [Cancel].

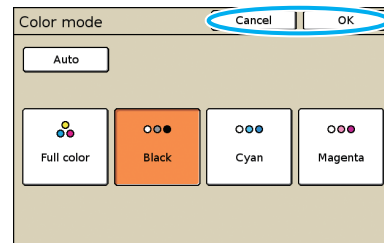

Logging In

Lock icons in the upper left corner of mode buttons indicate that you must log in to access those modes.

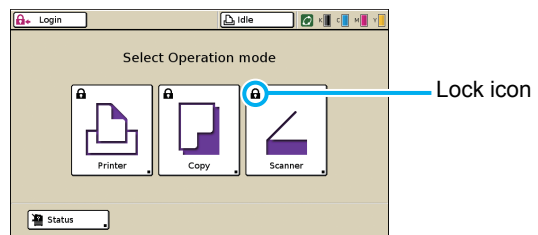

● How to Log In

 When using an optional IC card reader, you can log in by holding the IC card over the card reader.

1 Press [Login].

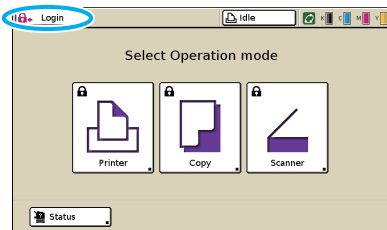

2 On the [Login] screen, select your name.

To find your name, press [▲] or [▼] at right to scroll through names, or press the index buttons on the bottom of the screen to display their corresponding names.

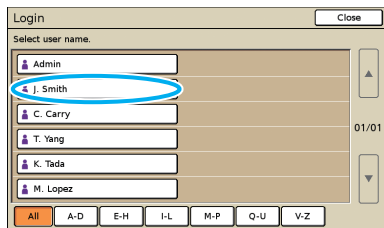

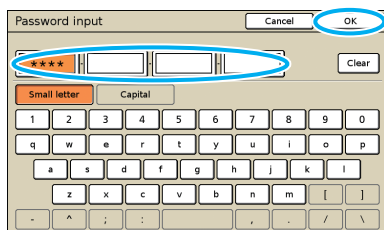

After you select your name, the [Password input] screen is displayed.

3 Enter the password and press [OK].



The screen for the mode you have logged in is displayed.

 After finishing operations, be sure to press [Logout].

 Ask your administrator if you cannot find your name, or if you have forgotten the password.

● Changing Login Passwords

1 Once you are logged in, press [Status] on the mode screen.

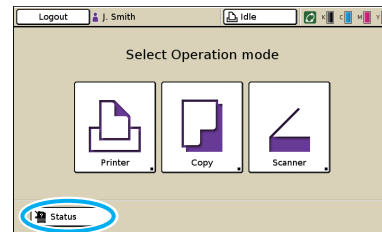

2 On the [User] screen, press [Password change].

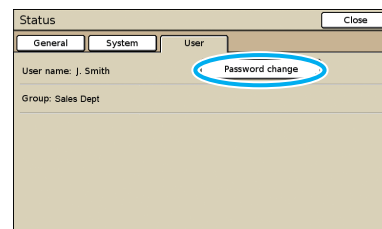

3 Enter the new password and press [Next].

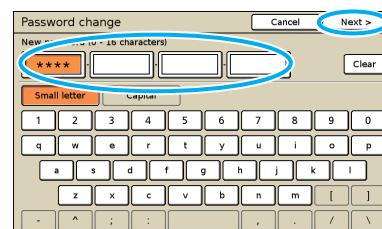

4 On the [Password change (input again)] screen, enter the new password again and press [OK].

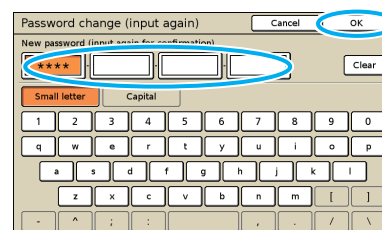

Entering Text

When entering user names or passwords, enter the required information on the text input screen.

1 Select the type of text to enter.

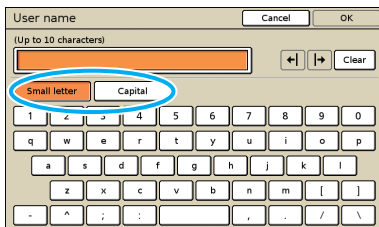

2 Press each character you want to enter.

To move the cursor, press [←] or [→]. To erase the character to the left of the cursor, press [Clear].

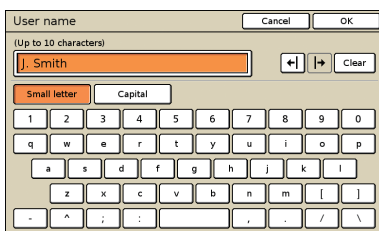

 The maximum number of characters to be entered is displayed above the text input field.

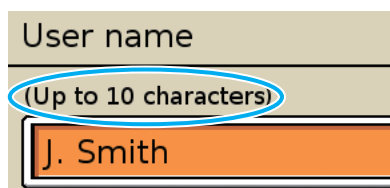

3 Press [OK] when input is complete.

 To cancel information you have entered, press [Cancel].

List of Settings for Each Mode

● Printer Driver

Setting	Description	See
[Basic] tab		
Color mode	Select color or monochrome printing.	p. 1-7
Duplex print	Specify simplex or duplex printing.	p. 1-7
Original size	Specify the paper size and orientation of the original.	p. 1-8
Mixed size* ¹ * ²	Specify this when the original has multiple sizes.	p. 1-8
Zoom	Specify enlargement or reduction of original images before printing, if needed.	p. 1-9
Paper size	Specify the size of paper for printing.	p. 1-9
Input tray* ¹	Specify the tray where paper for printing is loaded.	p. 1-9
Paper type	Specify the type of printing paper.	p. 1-10
Output	Select the output method (either [Print] or [Save to folder]) for original data sent from a computer.	p. 1-10
Destination	When [Output] has been set to [Print & Save to folder] or [Save to folder], this field indicates the directory.	p. 1-10
Save/Call setting	Save and call frequently used settings.	p. 1-11
[Layout] tab		
Imposition	Specify the type of imposition.	p. 1-12
Rotate	Specify this when rotating the original.	p. 1-14
Image position	Specify this when adjusting the print position.	p. 1-14
Save/Call setting	Save and call frequently used settings.	p. 1-14
[Image] tab		
Original image	Specify whether to emphasize the image quality of photos or text in originals.	p. 1-15
Line smoothing	Select this to smooth the outline of text or illustrations.	p. 1-15
Gamma control	Adjust the lightness, chroma, contrast, and RGB gamma value.	p. 1-15
Screening	Specify the method of halftone processing.	p. 1-16
Image quality	Specify the print resolution.	p. 1-16
Print density	Specify the print density.	p. 1-16
Save/Call setting	Save and call frequently used settings.	p. 1-16
[Finishing] tab		
Collate	Specify the collating option.	p. 1-17
Slip sheet* ¹	Specify the timing for slip sheet insertion between printouts.	p. 1-17
Offset output	Specify the timing to offset output. (When using the optional multifunction finisher or face down offset tray)	p. 1-18
Add cover* ¹	Specify this to add front and/or back cover.	p. 1-18
Booklet binding* ¹	Specify the type of booklet printing. (When using the optional multifunction finisher)	p. 1-18

Setting	Description	See
Binding side* ¹	Specify the position for stapling and punching. (When using the optional multifunction finisher)	p. 1-20
Staple* ¹	Select the stapling method. (When using the optional multifunction finisher)	p. 1-21
Punch* ¹	Select the punching method. (When using the optional multifunction finisher)	p. 1-22
Paper folding* ¹	Select this when folding paper in two. (When using the optional multifunction finisher)	p. 1-22
Output tray	Specify the output tray. (When using the optional multifunction finisher or stacking tray)	p. 1-23
Save/Call setting	Save and call frequently used settings.	p. 1-23
[Advanced] tab		
Copies	Enter the number of copies to print.	p. 1-23
Print and pause	To check the printing result, the machine stops after printing one set.	p. 1-23
Program	Specify this when distributing different numbers of copies to multiple groups.	p. 1-24
Blank Paper Cut Down	Specify this to not print blank pages of the original.	p. 1-24
Continuous output	Select this to switch the output tray automatically when the tray is full. (When using the optional multifunction finisher or stacking tray)	p. 1-25
Watermark	Specify the background watermark to be added to document pages.	p. 1-25
Stamp Page/Date	Stamp page number and date on the header or footer.	p. 1-26
PIN code	Assign a PIN code to a job to be printed or saved to a folder.	p. 1-27
Save/Call setting	Save and call frequently used settings.	p. 1-27

*1 This function is not available for ComColor 7010/7010R/3010/3010R.

*2 This function is not available for ComColor 3050/3050R.

● Copy Mode

	Setting	Description	See
[Basic]	Color mode	Select color or monochrome printing.	p. 2-8
	Reproduction size	Use this to reduce or enlarge the copied image.	p. 2-9
	Feed tray	Change the feed tray, paper type, and feed control settings according to the paper to be copied.	p. 2-9
	Original	Select the original type to perform the appropriate image processing and print the scanned data.	p. 2-12
	Scanning level	Adjust the scanning density of originals.	p. 2-13
	Duplex/Simplex	Specify the sides of the original to be read and the sides of the paper to be printed on.	p. 2-14
	Direct Access entry* ¹	Up to 4 frequently used functions can be registered to the direct access area.	p. 2-17
[Selections]	Selections entry* ¹	Up to 16 frequently used functions can be registered to the selections screen.	p. 2-17
[Functions]	Check setting	Confirm the current settings and print the settings information.	p. 2-18
	Save/Call setting	Up to 10 frequently used settings can be registered.	p. 2-19
	Select layout	Set various finishing settings by selecting an output image.	p. 2-22
	Copy and pause	To check the printing result when copying a large number of copies, the machine stops after printing one set.	p. 2-23
	Additional copies	Print one or more copies of previously copied original data.	p. 2-24
	Save to folder	Save scanned originals as data to the machine. You can retrieve the data and print it when needed.	p. 2-24
	Save to archive	Save scanned originals as data to an external controller. You can retrieve the data and print it when needed. (When using the optional ComColorExpress IS900C)	p. 2-26
	ADF scan & pause	Copy all originals together, even when copying a large quantity of originals that cannot be loaded at one time in the ADF.	p. 2-27
	Scanning size	Specify the scanning size of the original.	p. 2-27
	Mixed size original* ² * ³	Specify this option when the original has multiple sizes.	p. 2-28
	Book shadow erase	Remove shadows that appear in the center of copies when an open book is copied.	p. 2-29
	Multi-up	Specify Multi-up (Plural) (arranges continuous pages on one sheet) and Multi-up (Single) (arranges multiple copies of one page on one sheet) copying.	p. 2-30
	Stamp Page/Date	Stamp the page number and date on the header or footer.	p. 2-31
	Image quality	Specify the resolution for scanning originals.	p. 2-33
Gamma control	Adjust the color balance (CMYK) of scanned data.	p. 2-34	
Image control	Specify the image processing of the original.	p. 2-35	

	Setting	Description	See
[Functions]	Base color level	Make the background color (base color) lighter so that the text is easier to read.	p. 2-35
	Program	Specify this when the number of required copies varies by group (such as corporate division or classes). You can quickly print exactly the number of copies of the number of sets you need.	p. 2-36
	Add cover* ²	Specify this to add front and back covers to the front and back of the printout.	p. 2-40
	Collate/slip sheet* ²	Specify the type of collation and slip sheet.	p. 2-41
	Auto-Rotate	Rotate the image 90 degrees automatically when the orientation of the original and paper do not match.	p. 2-43
	Staple/Punch* ²	Specify the position for stapling and punching. (When using the optional multifunction finisher)	p. 2-43
	Paper folding* ²	Select this when folding paper in two. (When using the optional multifunction finisher)	p. 2-45
	Booklet* ²	Specify the imposition and paper folding when creating a booklet. (When using the optional multifunction finisher)	p. 2-47
	Output tray	Specify the output tray for the copies and continuous output settings. (When using the optional multifunction finisher or stacking tray)	p. 2-49
	Paper guide control	Adjust the position of the paper guides of the RISO auto-control guide stacking tray. (When using the optional RISO auto-control stacking tray)	p. 2-50
	Jump wing control	Adjust the position of the jump wing. (When using the optional stacking tray)	p. 2-51
	Head cleaning	Clean the ink heads.	p. 2-51
	Front doors release	Release the front door lock.	p. 2-52

*1 Depending on the administrator setting, this button may not be displayed.

*2 This function is not available for ComColor 7010/7010R/3010/3010R.

*3 This function is not available for ComColor 3050/3050R.

● Scanner Mode

	Setting	Description	See
[Basic]	File format	Specify the file format, compression level and resolution for saving the scanned data.	p. 3-9
	Reproduction size	Enlarge or reduce the scanned data.	p. 3-10
	Image size	Specify the page size for saving scanned data.	p. 3-10
	Color mode	Specify the color mode of the data to be scanned.	p. 3-11
	Scanning level	Adjust the scanning density for originals.	p. 3-12
	Duplex/Simplex	Specify sides of the original to be scanned.	p. 3-12
[Functions]	Check setting	Confirm and register the current settings and print the settings information.	p. 3-13
	Save/Call setting	Up to 10 frequently used settings can be registered.	p. 3-13
	Original	Select the original type to perform the appropriate image processing and save the scanned data.	p. 3-13
	Book shadow erase	Remove shadows that appear in the center of copies when an open book is copied.	p. 3-14
	Scanning size	Specify the scanning size for originals to be scanned.	p. 3-14
	Mixed size original	Specify this when the original has multiple sizes.	p. 3-14
	Gamma control	Adjust the color balance (CMYK) of originals.	p. 3-14
	Image control	Specify the image processing of the original.	p. 3-14
	Base color level	Make the background color (base color) lighter so that the text is easier to read.	p. 3-14
	PIN code	Assign PIN codes when saving scanned jobs on the internal hard disk.	p. 3-15
	Front doors release	Release the front door lock.	p. 3-15

● Printer Mode

	Setting	Description	See
[Active]	Delete, Print, Details	Confirm details of, print, and delete active jobs.	p. 4-6
[Waiting]		Confirm details of, print, and delete waiting jobs.	p. 4-7
[Finished]		Confirm details of, print, and delete finished jobs.	p. 4-8
[Folder]		Confirm details of, print, and copy folder jobs.	p. 4-9
[Functions]	Online	Set the machine online or offline.	p. 4-14
	Feed tray	Specify the feed tray, paper size, feed control, and double feed check settings for each feed tray.	p. 4-14
	Head cleaning	Clean the ink heads.	p. 4-15
	Paper guide control	Adjust the paper guide position of the RISO auto-control stacking tray. (When using the optional RISO auto-control stacking tray)	p. 4-15
	Jump wing control	Adjust the position of the jump wing. (When using the optional stacking tray)	p. 4-15
	Front doors release	Release the front door lock.	p. 4-15

Print Preparations

Before printing, load the paper, set the stacking tray (optional) so the machine is ready for use.



- When using the feed tray, you do not need to set the standard tray.
- With the RISO console, you can check the status of the machine on your computer. (p. 5-1 "RISO Console")

Turning the Power On/Off

The machine has two power switches: [Main power] switch and [Sub power] key. The [Main power] switch turns the printer unit on and off. Press the [Sub power] key to operate the machine. The button is lit when the power is turned on.



When the optional scanner or multifunction finisher is connected to the machine, the power of the optional equipment is turned on and off by the power of the machine.

Turning the Power On

- 1 Make sure that the power plug is inserted into an electrical outlet.
- 2 Turn on the [Main power] switch.

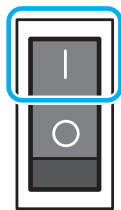

The [Main power] lamp turns on.

3

Press the [Sub power] key on the machine.

The key is lit when the power is on.

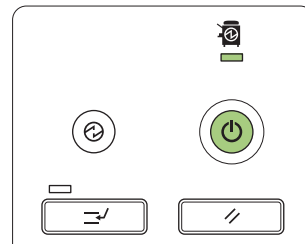

Turning the Power Off

- 1 Press and hold the [Sub power] key.
The key turns off.
 - 2 Check that the [Sub power] key is off, then turn off the [Main power] switch.
The [Main power] lamp turns off.
- Wait until the [Main power] lamp turns off before turning on the [Main power] switch again.
 - Turn off the [Main power] switch before removing the power plug.

■ Power-saving features

The machine has the following energy-saving features.

- **Backlight OFF**

The status in which the touch panel backlight is off and the [Wake up] key is lit. This status is automatically activated when the machine is not operated for a fixed period. In this case, normal status is restored immediately after an original is loaded in the scanner or any button on the operation panel is pressed.

- **Sleep status**

The status in which the touch panel is off and the [Wake up] key is lit. When the machine is not operated for a fixed period, the machine enters a mode similar to when the [Sub power] is off. Press the [Wake up] key to restore.



- The machine requires more time to resume operations from sleep status than from backlight OFF.
- Use [Power save setting] of the administrator settings to configure the time until the power-saving features activate. For details, ask your administrator.

Loading Paper

Load paper in the feed trays and the standard tray.



We recommend loading the feed trays with types of paper you will use most often.

Use the standard tray for the following types of paper.

- Thick paper and other special paper
- Preprinted paper
- Postcards
- Envelopes

For details, see "Printing Paper" in the "Safety Information".

● In the Feed Trays

1 Pull a tray out, toward the front.

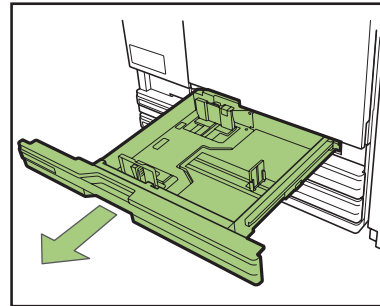

2 Push the right side of the locking lever (in back) to free. Holding the front tab, spread the guides fully apart.

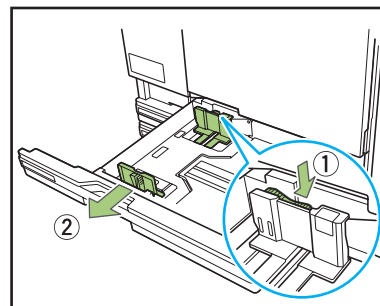

3 Move the stopper to make space.

Hold the stopper from both sides and move it out of the way.

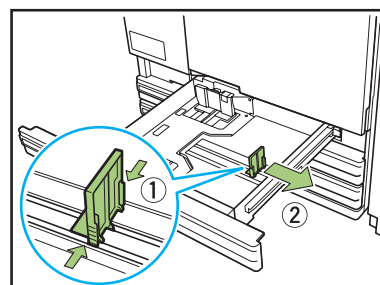

4 Load the paper.

When using paper with different characteristics on the front and back sides, load the printing side face-down. Do not load too many sheets.

When loading the paper, be careful not to let its edge contact the paper guides to prevent it from being bent.

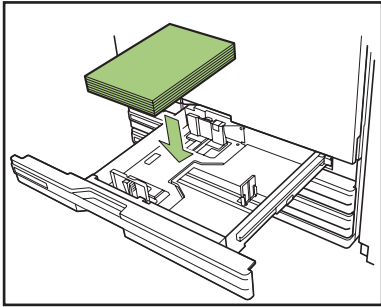

5 Move the guides against the edges of the paper, and push the lever to lock.

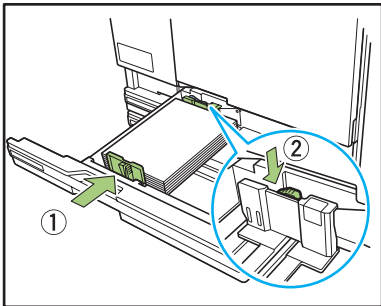

6 Move the stopper against the edge of the paper.

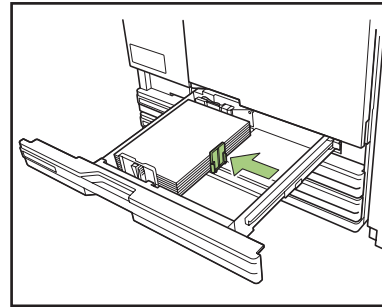

! Be sure to move the stopper against the edge of the paper. The machine determines the size of the paper based on the stopper position.

7 Push the tray back into the machine.

8 On the operation panel, check the tray settings.

When you have switched to a different type or size of paper, update the feed tray settings (p. 2-9 "Feed tray").

In the Standard Tray

- 1 Open the standard tray until it stops.**

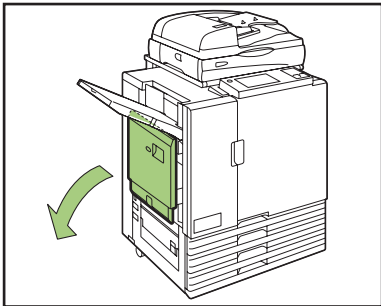

- 2 Spread the guides.**

Set the paper feed guide levers (in two positions on both sides) to unlock the guides and slide the guides.

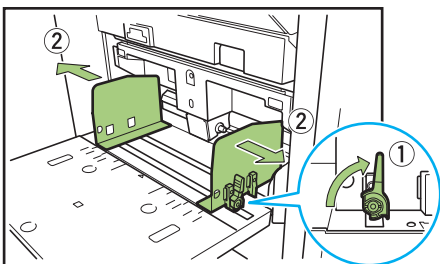

- 3 Load the paper.**

Load paper with the printing side face-up.

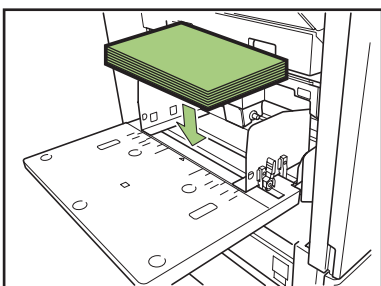

- Printing on envelopes requires a multifunction finisher or stacking tray.
- Be sure to load an envelope with its flap open and its bottom side entering the machine first.

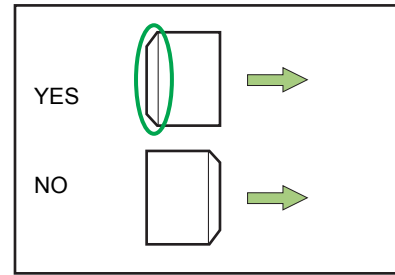

- 4 Move the guides against the edges of the paper, and push the lever to lock.**

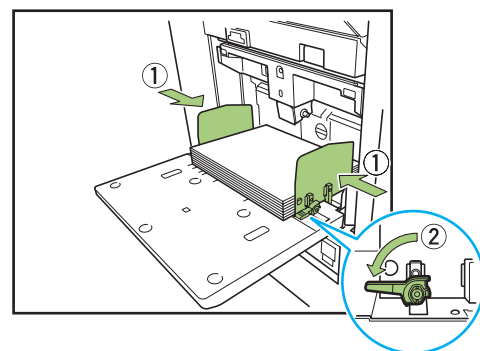

- 5 Set the paper feed pressure adjustment lever.**

Normally, keep this lever in the "✖ (NORMAL)" position unless you set it to "≠ (CARD)" for envelopes and similar paper.

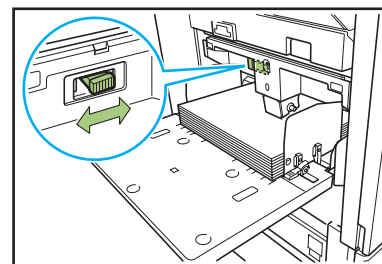

- 6 On the operation panel, check the tray settings (p. 2-9 "Feed tray").**

When you have switched to a different type or size of paper, update the feed tray settings.



The [Rotate] feature is convenient when printing on envelopes from a computer.

● Adding or Switching Paper in the Standard Tray

Press the standard tray descent button when loading additional sheets or when switching paper. Note that the standard tray is automatically lowered when all paper is removed.

1 Press the standard tray descent button to lower the standard tray.

Hold the button down until the tray reaches the desired position.

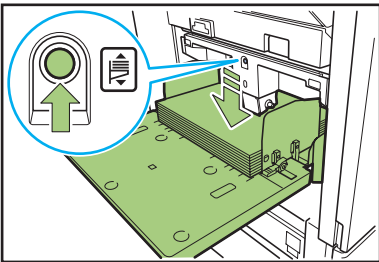

2 Load additional paper, or switch the loaded paper.

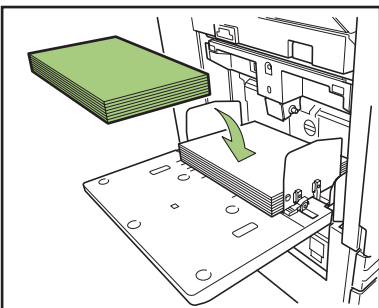

● Closing the Standard Tray

1 Remove the loaded paper.

The standard tray starts lowering.

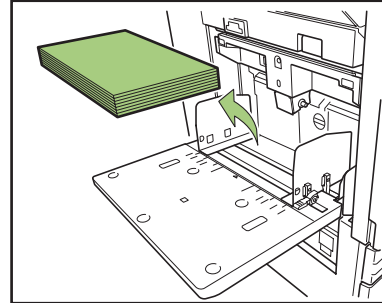

! Make sure the machine is on.

2 Close the standard tray.

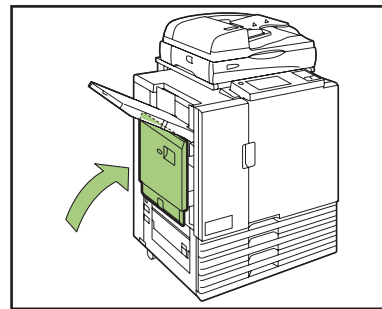

! Make sure the standard tray is all the way down before closing it.

Preparing the Stacking Tray (optional)

Set up the stacking tray as follows. Depending on the size or type of paper for printing, also adjust the paper arranger at this time.

- The RISO auto-control stacking tray is shown in this illustration.
- When using the wide stacking tray, manually adjust the paper guides' (side and end) positions to fit the paper size.

1 Open the stacking tray until it stops.

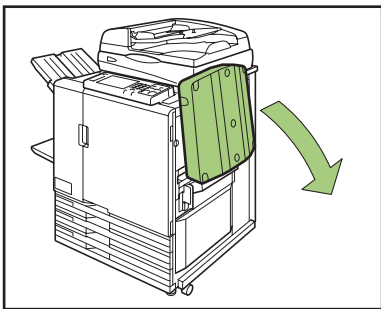

2 Lift the paper guides (side) to stand them upright.

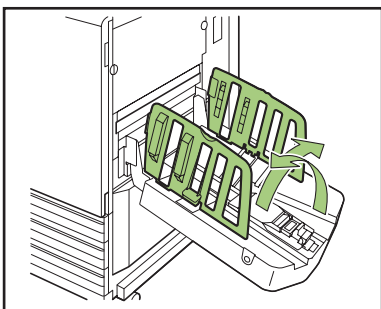

3 Adjust the paper arranger.

Normally, the paper arranger should be extended when printing on paper that is B4 size or smaller. How paper is stacked after printing varies depending on stiffness and other factors. Adjust the arranger as needed.

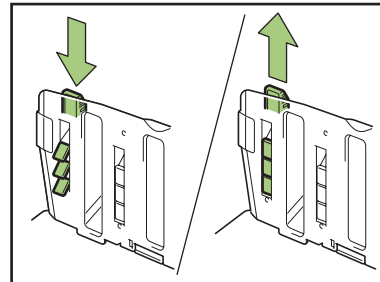

4 Lift the paper guide (end) to stand it upright.

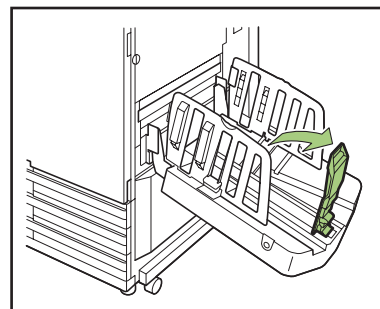

- For RISO auto-control stacking tray. Fold all paper guides when printing on paper larger than 320 × 432 mm (12 1/2" × 17").
- For the wide stacking tray. Set the tray to a different position, when printing on paper larger than A3 or Ledger. See the instruction label on the machine.

● Closing the Stacking Tray

- 1 After confirming that there are no printouts in the stacking tray, press the paper guides open button.

The paper guides (side and end) now move into position for storage.

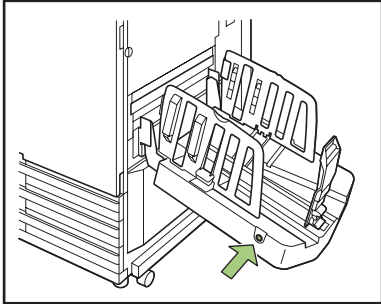

- ! The wide stacking tray does not include a paper guides open button. Manually spread the paper guides apart.

- 2 Lower the paper guide (end) toward the stacking tray to fold it up.

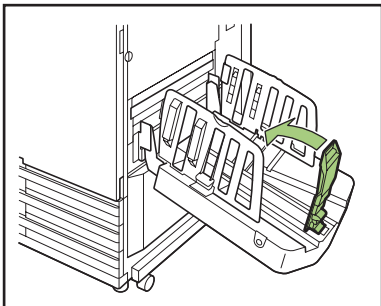

- 3 Fold up the paper arranger.

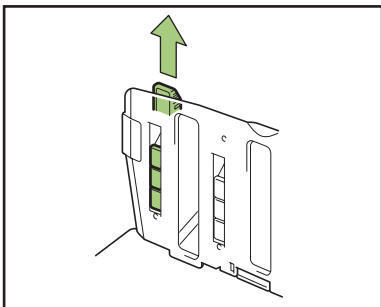

- 4 Lower the paper guides (side) inward, and then close the stacking tray.

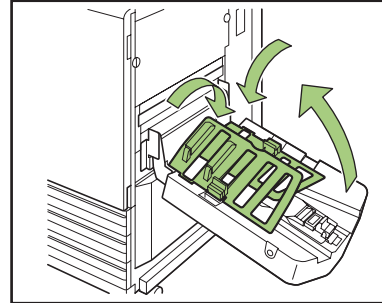



1



Printer Driver

Overview of Print Operations

This chapter describes how to use the machine as a printer from a computer when it has been connected to the machine via network.

Printer Driver Screen

Use the printer driver screen to configure the various settings.

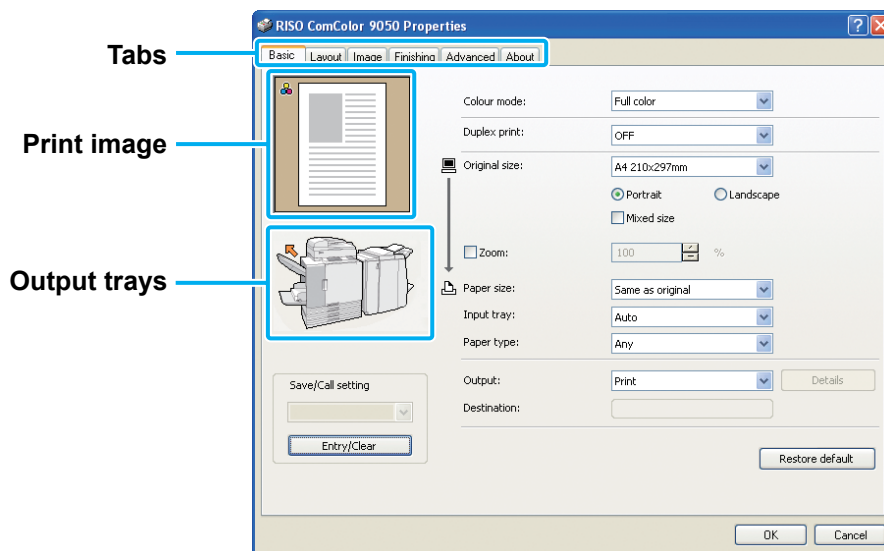

- Tab : Click a tab to switch the screens.
- Print image : Displays a preview image of the document to be printed. The color mode icon is displayed at the top left of the preview image. (The icon is not displayed when [Color mode] is set to "Auto".)
- Output trays : Displays the output trays with orange arrows.

The following are the components of the printer driver screen.

Tabs	Description	See
Basic	Specify basic print settings, such as for the color mode and paper used.	p. 1-7
Layout	Specify settings to impose, or to print images rotated.	p. 1-12
Image	Specify the image quality and density.	p. 1-15
Finishing	Specify finishing settings, such as for collation and booklet binding.	p. 1-17
Advanced	Specify advanced settings, such as for PIN codes and the print and pause function.	p. 1-23
About	Display printer driver information.	p. 1-27



- The displayed settings vary depending on the selected item and how the administrator has configured the settings.
- An option setting is displayed only when optional equipment required for that setting has been connected.
- The operations described in this guide use screenshots from Windows XP.



- Clicking [Restore default] restores all settings on the printer driver screen to their default values.
- When a multifunction finisher or other optional part has been connected, first configure [Printer configuration]. If [Printer configuration] has not been configured correctly, the required buttons are not displayed on the printer driver screen. (p. 1-28 "[Environment] Tab")

Procedure

The printing workflow is as follows.

- 1 Display the printer driver screen
- 2 Configure the settings as needed
- 3 Click [OK]
- 4 Click [Print]

● 1 Displaying the Printer Driver Screen

1 Select the print option in the application on the computer.

The print dialog box is displayed.

2 Confirm that this machine has been selected for [Printer name] and click [Properties] or [Details].

The button names are different depending on the application.

● 2 Configuring the Settings as Needed

For information on the settings that can be configured, see "List of Settings" (p. 1-5).

- To restore all settings on the printer driver screen to their default values, click [Restore default].
- To cancel the settings, click [Cancel].



- When using a multifunction finisher
When [Staple], [Punch], and other items have been grayed out on the [Finishing] tab, make sure that the [Printer configuration] settings on the [Environment] tab have been configured correctly. (p. 1-28 "Environment Settings")
- The [Original image] and [Paper type] settings of the printer driver greatly affect the print quality. Change the settings according to use conditions.

● 3 Click [OK]

The print dialog box is displayed.



When the [Collate] check box on the print dialog box has been selected, remove the check mark. If you do not remove the check mark, data is sent from the computer to the machine the number of times that copies are specified.

- Specify [Sort] in [Collate] on the [Finishing] tab for collated printing.

● 4 Click [Print] or [OK]

Printing starts.

List of Settings

The following is a list of the settings on the printer driver screen.



- The settings displayed on the screen vary depending on the selected item and how the administrator has configured the settings.
- An option setting is displayed only when optional equipment required for that setting has been connected.

1

Setting	Description	See
[Basic] tab		
Color mode	Select color or monochrome printing.	p. 1-7
Duplex print	Specify simplex or duplex printing.	p. 1-7
Original size	Specify the paper size and orientation of the original.	p. 1-8
Mixed size*1 *2	Specify this when the original has multiple sizes.	p. 1-8
Zoom	Specify enlargement or reduction of original images before printing, if needed.	p. 1-9
Paper size	Specify the size of paper for printing.	p. 1-9
Input tray*1	Specify the tray where paper for printing is loaded.	p. 1-9
Paper type	Specify the type of printing paper.	p. 1-10
Output	Select the output method (either [Print] or [Save to folder]) for original data sent from a computer.	p. 1-10
Destination	When [Output] has been set to [Print & Save to folder] or [Save to folder], this field indicates the directory.	p. 1-10
Save/Call setting	Save and call frequently used settings.	p. 1-11
[Layout] tab		
Imposition	Specify the type of imposition.	p. 1-12
Rotate	Specify this when rotating the original.	p. 1-14
Image position	Specify this when adjusting the print position.	p. 1-14
Save/Call setting	Save and call frequently used settings.	p. 1-14
[Image] tab		
Original image	Specify whether to emphasize the image quality of photos or text in originals.	p. 1-15
Line smoothing	Select this to smooth the outline of text or illustrations.	p. 1-15
Gamma control	Adjust the lightness, chroma, contrast, and RGB gamma value.	p. 1-15
Screening	Specify the method of halftone processing.	p. 1-16
Image quality	Specify the print resolution.	p. 1-16
Print density	Specify the print density.	p. 1-16
Save/Call setting	Save and call frequently used settings.	p. 1-16
[Finishing] tab		
Collate	Specify the collating option.	p. 1-17
Slip sheet*1	Specify the timing for slip sheet insertion between printouts.	p. 1-17
Offset output	Specify the timing to offset output. (When using the optional multifunction finisher or face down offset tray)	p. 1-18
Add cover*1	Specify this to add front and/or back cover.	p. 1-18

Setting	Description	See
Booklet binding* ¹	Specify the type of booklet printing. (When using the optional multifunction finisher)	p. 1-18
Binding side* ¹	Select the stapling and punching. (When using the optional multifunction finisher)	p. 1-20
Staple* ¹	Select the stapling method. (When using the optional multifunction finisher)	p. 1-21
Punch* ¹	Select the punching method. (When using the optional multifunction finisher)	p. 1-22
Paper folding* ¹	Specify this when folding paper in two. (When using the optional multifunction finisher)	p. 1-22
Output tray	Specify the output tray. (When using the optional multifunction finisher or stacking tray)	p. 1-23
Save/Call setting	Save and call frequently used settings.	p. 1-23
[Advanced] tab		
Copies	Specify the number of copies to print.	p. 1-23
Print and pause	To check the printing result, the machine stops after printing one set.	p. 1-23
Program	Specify this when distributing different numbers of copies to multiple groups.	p. 1-24
Blank Paper Cut Down	Specify this to not print blank pages of the original.	p. 1-24
Continuous output	Select this to switch the output tray automatically when the tray is full. (When using the optional multifunction finisher or stacking tray)	p. 1-25
Watermark	Specify the background watermark to be added to document pages.	p. 1-25
Stamp Page/Date	Stamp the page number and date on the header or footer.	p. 1-26
PIN code	Assign a PIN code to a job to be printed or saved to a folder.	p. 1-27
Save/Call setting	Save and call frequently used settings.	p. 1-27

*1 This function is not available for ComColor 7010/7010R/3010/3010R.

*2 This function is not available for ComColor 3050/3050R.

Basic Settings

This section describes how to configure the basic settings of the printer driver, such as for color mode, duplex printing, and paper type.

[Basic] Tab

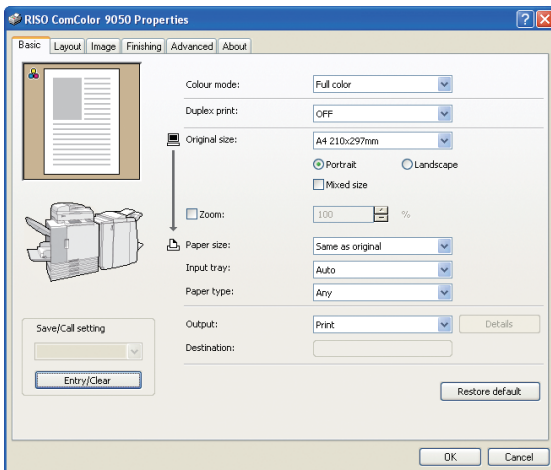

● Color mode

Select color or monochrome printing.

[Auto]

Determine the color of the original automatically and prints in full color (cyan, magenta, yellow, and black) or black.

[Full color]

Print in four colors (cyan, magenta, yellow, and black).

[Black]

Print in one color (black) regardless of the color of the original.

[Cyan]

Print in one color (cyan) regardless of the color of the original.

[Magenta]

Print in one color (magenta) regardless of the color of the original.



"Auto" and "Full color" are not displayed when the administrator has restricted color printing.

● Duplex print

Specify simplex or duplex printing.

[OFF]

Simplex printing is performed.

[Long edge]

Duplex printing is performed with the long edge as the binding position.

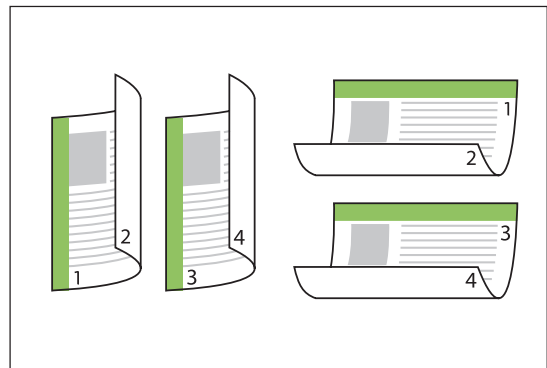

[Short edge]

Duplex printing is performed with the short edge as the binding position.

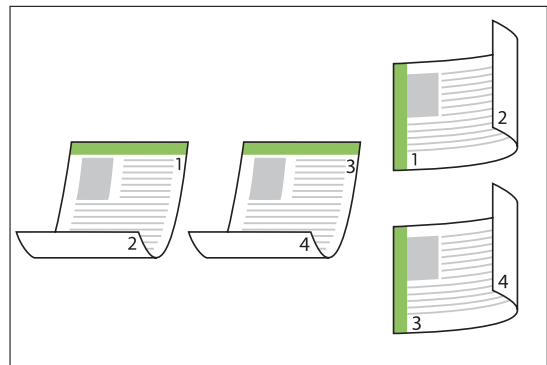

● Original size

Specify the paper size and orientation of the original.

Select from the following.

[A3W], [A3], [A4], [A5], [A6], [B4], [B5], [B6],
[Foolscap], [Tabloid], [Legal], [Letter],
[Statement], [C4], [C5], [C6], [DL-R], [Envelope 1],
[Envelope 2], [No.10 envelope], [custom]

Orientation of original

[Portrait], [Landscape]

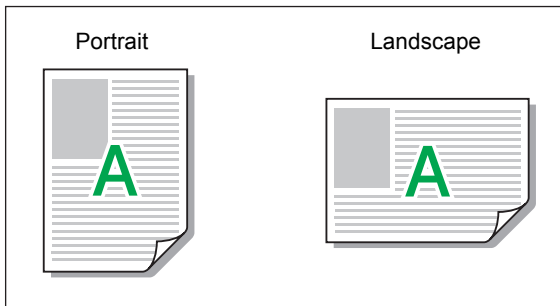

Envelopes cannot be outputted from the face down tray. An optional stacking tray or multifunction finisher is required.



This pull-down menu shows the sizes registered with [Custom paper entry] on the [Environment] tab. (p. 1-29 "Custom paper entry")

■ Specifying a Custom Size

When the original is a non-standard size, select [custom].



Select [custom] for [Original size].

The dialog box for specifying the custom size is displayed.

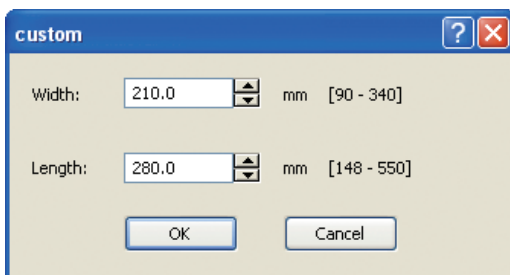

2 Enter the size of the original.

Specify a width between 90 mm (3 9/16") and 340 mm (13 3/8").

Specify a length between 148 mm (5 13/16") and 550 mm (21 5/8").



3 Click [OK].

- To cancel the settings, click [Cancel].



The size entered here is only valid when configuring the size of the original. Registering frequently used original sizes can be useful. (p. 1-29 "Custom paper entry")

● Mixed size

Specify this option when the original has multiple sizes.

Selecting this check box specifies the feed tray automatically according to the original size.



- You cannot use [Mixed size] and [Imposition] at the same time. (p. 1-12 "Imposition")
- When the [Mixed size] has been selected, the staple, punch, and offset output functions cannot be configured.



When using this function with duplex printing, duplex printing can only be performed if the size of the front and back of the original is the same. (If the size is not the same, the back of the page is left blank.)

● Zoom

Specify the enlarge/reduce ratio of the original.

Select the [Zoom] check box and enter the enlarge/reduce ratio from 50% to 200%.

When the [Zoom] check box has not been not selected, the enlarge/reduce ratio is selected automatically according to the [Original size] and [Paper size] settings.

● Paper size

Specify the size of paper for printing.
Select from the following.

[A3W], [A3], [A4], [A5], [A6], [B4], [B5], [B6], [C4], [C5], [C6], [DL-R], [Envelope 1], [Envelope 2], [No.10 envelope], [Foolscap], [Tabloid], [Legal], [Letter], [Statement], [custom], [Same as original]



Envelopes cannot be outputted from the face down tray. An optional stacking tray or multifunction finisher is required.



This pull-down menu shows the sizes registered with [Custom paper entry] on the [Environment] tab. (p. 1-29 "Custom paper entry")

■ Specifying a Custom Paper Size

When the paper is a non-standard size, select [custom].



Select [custom] for [Paper size].

The dialog box for specifying the custom size is displayed.

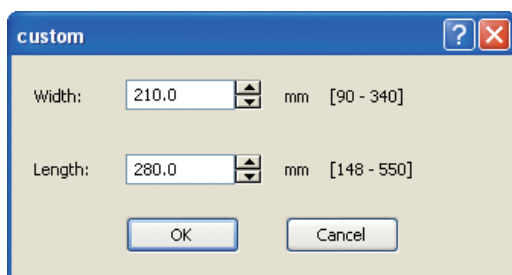

2 Enter the size of the paper.

Specify a width between 90 mm (3 9/16") and 340 mm (13 3/8").

Specify a length between 148 mm (5 13/16") and 550 mm (21 5/8").



3 Click [OK].

- To cancel the settings, click [Cancel].



The size entered here is only valid when configuring the paper size. Registering frequently used paper sizes can be useful. (p. 1-29 "Custom paper entry")

● Input tray

Specify the input tray to use for printing.

[Auto]

The feed tray is selected automatically according to the [Paper type] and [Paper size] settings.

[Feed tray1] - [Feed tray3]

The paper loaded in the specified tray is used for printing.

[Standard tray]

The paper loaded in the standard tray is used for printing.



When [Auto] has been selected but the paper matching the "Paper size" and "Paper type" settings has not been loaded (or the paper is loaded but [Manual] has been selected for [Tray selection]), an error occurs and the job is not printed. See "[Any]" (p. 1-10) in "Paper type".



You can use the RISO Console to confirm the paper size and paper type loaded in the printer feed tray. (p. 5-4 "[General] Screen" in "RISO Console")

● Paper type

Select the type of printing paper. During printing, the ink amount is adjusted and image processing is performed to match the selected paper type.

[Any]

Set the paper type of the corresponding tray or the [Default paper type of "Any"] setting on the [Environment] tab.

[Plain]

[IJ paper], [Matt coated]

Select one of these when using IJ paper or similar paper.

[High-quality]

[Card-IJ]



This printer selects the optimal color profile according to the paper type. To print with the appropriate color balance, match the printer paper settings with the loaded paper.

Color Profile

Colors on a monitor or other display are expressed in terms of the three primary colors of light (RGB: red, green, and blue), however colors printed with ink are expressed in terms of the three primary colors (CMY: cyan, magenta, and yellow).

Because CMY, which is used to express the colors printed on paper, has fewer colors than RGB, which is used to express colors displayed on a computer monitor, the printer cannot print the colors exactly as seen on the monitor. For this reason, it is necessary to use a special method to convert RGB colors to CMY colors so as to reproduce nearly the same colors or natural colors.

This method is called "color management", and the conversion table is called a "color profile".

With color management, the printer automatically selects several types of color profiles to obtain the optimal color according to the combination of the original image and paper being used.

- This printer uses created and edited color profiles based on Color Tune® technology licensed from Monotype Imaging K.K.

● Output and Destination

Specify whether to print the data sent from a computer or save it to a folder on the printer.

[Print]

Print the data.

[Print & Save to folder]

Print the original data and saves it in a folder.

[Save to folder]

Save the original data in a folder.



Depending on the administrator setting, the folder functions may not be usable.



- Data saved in folders can be printed from the [Folder] Screen in printer mode (p. 4-9) or the [Folder] Screen of the RISO Console (p. 5-11).
- The computer user name is added as the [owner] to the data saved to a folder.

■ Selecting the Destination Folder

The folders registered with [Register folder] on the [Environment] tab are displayed in [Destination]. (p. 1-28 "[Environment] Tab")



In [Output], select either [Print & Save to folder] or [Save to folder].



Click [Details].

The [Output] dialog box is displayed.



In the [Destination] pull-down menu, select the directory of the original data.

- The available folders are displayed in the [Destination] list.
- You can enter up to 128 characters for comments to the printer users in the [Job comment] field.
- You can display job comments using the touch panel of the printer or the RISO Console.

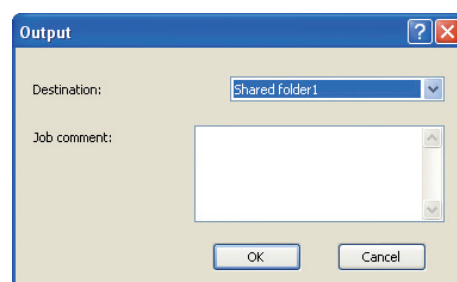

4 Click [OK].

The specified folder name is displayed in the [Destination] field.

- To cancel the settings, click [Cancel].

Save/Call setting

The current settings on the printer driver screen can be saved and retrieved later as needed. Up to 10 groups of settings can be saved.

Saving Settings**1 Configure the necessary settings on the printer driver screen.****2 Click [Entry/Clear] for [Save/Call setting].**

The [Entry/Clear] dialog box is displayed.

3 Enter a name.

- Enter a name of up to 10 characters long.

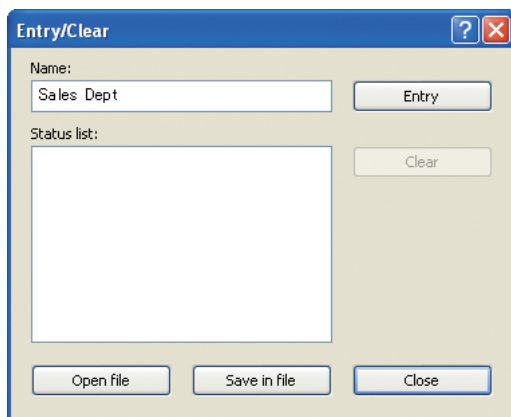
**4 Click [Entry].**

The settings are saved and displayed in [Status list].

5 Click [Close].**Retrieving Settings****1 Select the necessary settings in the [Save/Call setting] pull-down menu.**

The selected settings become the output settings of the printer driver.

Clearing Settings**1 Click [Entry/Clear] for [Save/Call setting].**

The [Entry/Clear] dialog box is displayed.

2 Select the settings to delete in [Status list].**3 Click [Clear].****4 Click [Close].****Saving Settings to a Computer**

You can save the saved settings to a computer. It is useful to save settings to a computer when, for example, you want to share the settings among multiple users or reinstall the printer driver.

1 Click [Entry/Clear] for [Save/Call setting].

The [Entry/Clear] dialog box is displayed.

2 Select the settings to save in [Status list].**3 Click [Save in file].**

The [Save As] dialog box is displayed.

4 Specify the destination folder and file name.

5 Click [Save].

The selected settings are saved.

Reading Settings from a Computer

You can retrieve and use settings saved to a computer.

1 Click [Entry/Clear] for [Save/Call setting].

The [Entry/Clear] dialog box is displayed.

2 Click [Open file].

The [Open file] dialog box is displayed.

3 Select the file on the computer.

4 Click [Open].

The read settings are displayed in [Status list] on the [Entry/Clear] dialog box.

[Layout] Tab

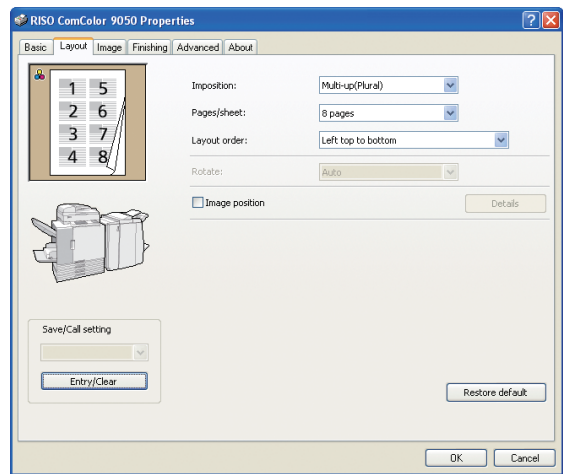

Imposition

Impose an original with several pages onto one sheet. The setting items differ depending on the imposition type.

[OFF]

No imposition is performed.

[Multi-up (Plural)]

Continuous multiple pages are printed in order on one sheet. Select the number of pages per sheet and the layout order.

[Multi-up (Single)]

The same page is printed multiple times on one sheet. Select the number of pages per sheet.

[Booklet]

Continuous multiple pages are imposed and printed to create a middle-binding booklet after duplex printing.



You cannot use "Imposition" and "Mixed size" at the same time. (p. 1-8 "Mixed size")

■ Multi-up (Plural) Setting

- Pages/sheet
 - Select the number of pages per sheet.
 - [2 pages], [4 pages], [8 pages]**
- Layout order
 - Specify the layout order.
 - When specifying [2 pages]
 - [Left to right (T to B)]**
 - [Right to left (B to T)]**
 - When specifying [4 pages] or [8 pages]
 - [Left top to right], [Right top to left], [Left top to bottom], [Right top to bottom]**

Example: When "Pages/sheet" is set to [4 pages] and "Layout order" is set to [Left top to bottom]

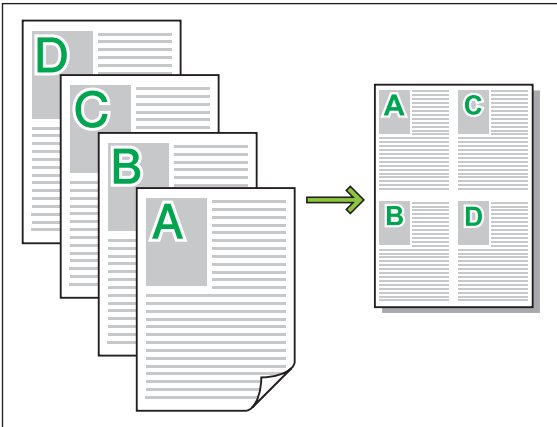

■ Multi-up (Single) Setting

- Pages/sheet
 - Select the number of pages per sheet.
 - [2 pages], [4 pages], [8 pages]**

Example: When "Pages/sheet" is set to [4 pages]

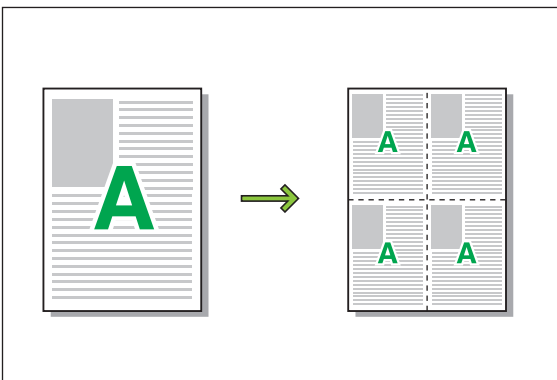

■ Booklet Setting

- Layout order
 - Specify the layout order.
 - When the original size has been set to [Portrait]
 - [Left to right]/[Right to left]**
 - When the original size has been set to [Landscape]
 - [Top to Bottom]**

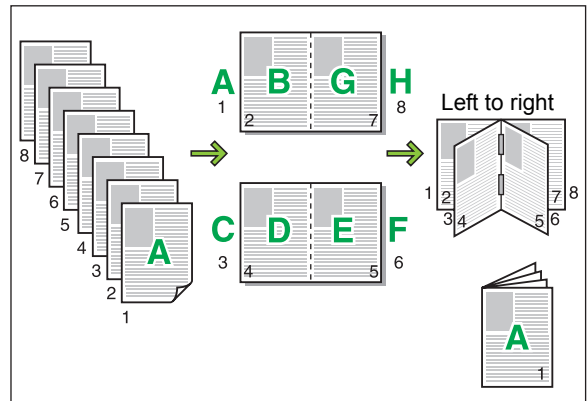

- You cannot use "Booklet" and "Staple" or "Punch" at the same time. (p. 1-21 "Staple", p. 1-22 "Punch")
- To create a booklet (folded or with middle-binding staples), configure the [Finishing] tab.

● Rotate

Specify this option when rotating the original. Select from the following.

[Auto], [0 degree], [90 degrees], [180 degrees], [270 degrees]

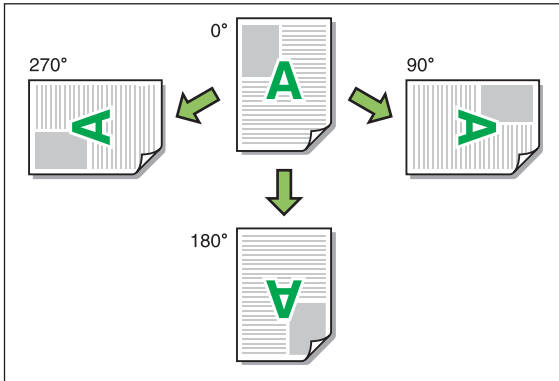

When [Auto] has been selected, the print orientation is set automatically according to the orientation of the original data and the orientation of the paper loaded in the input tray. Normally, select [Auto].



- To align the print orientation with an envelope or other paper with a fixed feeding direction, specify the angle of rotation.
- [Auto] may be the only option available depending on the size of the original, the size and orientation of the paper loaded in the tray, and the settings of an optional multifunction finisher.

● Image position

You can adjust the print position ± 20 mm (13/16") up, down, left, or right. When performing duplex printing, the front and back sides are adjusted separately.

Select the [Image position] check box and click [Details] to display the [Image position] dialog box.

Select the side to adjust and enter the desired value in the input box.

[Front Side]

Adjust the position of the front side.

[Back Side]

Adjust the position of the back side.

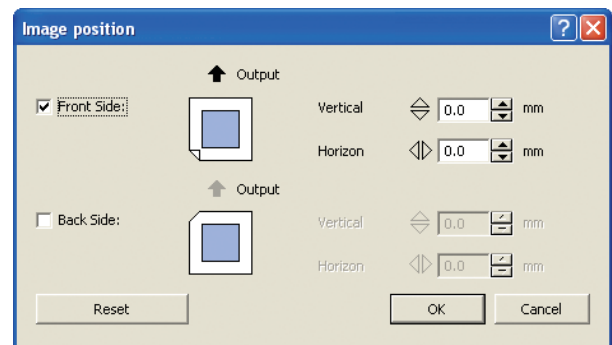

Clicking [Reset] resets all values to zero.

● Save/Call setting

The current settings on the printer driver screen can be saved and retrieved later as needed. See "Save/Call setting" (p. 1-11) in "[Basic] Tab" for details.

[Image] Tab

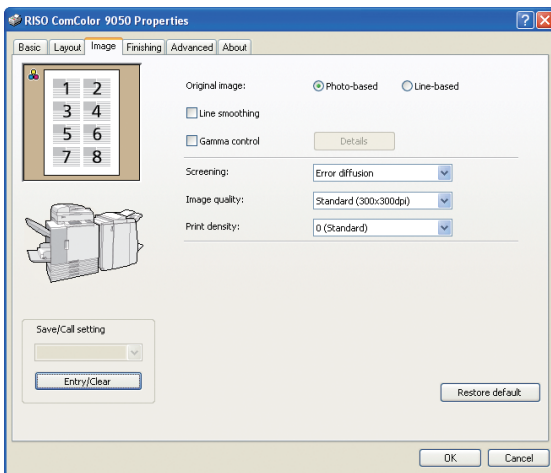

● Original image

Select whether to give priority to the image quality of photos or text in originals.

[Photo-based]

Process image data with more natural colors.

[Line-based]

Process text and illustrations with sharp rendering.

● Line smoothing

Supplement the intermediate colors of drawing and background colors in outline sections of text or illustrations (line drawing) to make the outlines smoother. To enable this processing, select the [Line smoothing] check box.

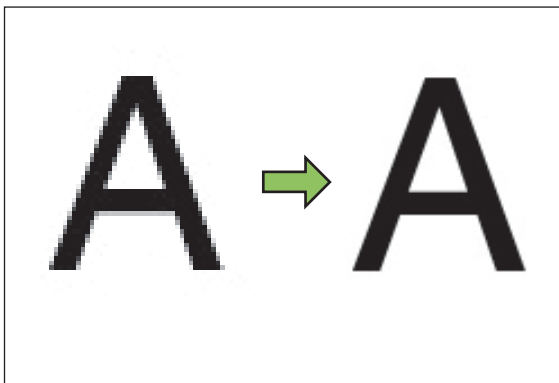

Image



Printing will take longer if you have selected [Line smoothing].

● Gamma control

Adjust the lightness, chroma, contrast, and RGB gamma value.

Select the [Gamma control] check box and click [Details] to display the [Gamma control] dialog box. Specify a value between -25 and +25 for each item.

● Lightness

The smaller the value, the darker (blackish) the color.
The larger the value, the brighter (whitish) the color.

● Chroma

The smaller the value, the more washed-out the color.
The larger the value, the more vivid the color.

● Contrast (ratio of brightness to darkness)

The smaller the value, the lower the contrast. The larger the value, the higher the contrast.

● Red, Green, Blue

Adjust the gamma value of colors.

The smaller the value, the weaker the color. The larger the value, the stronger the color.

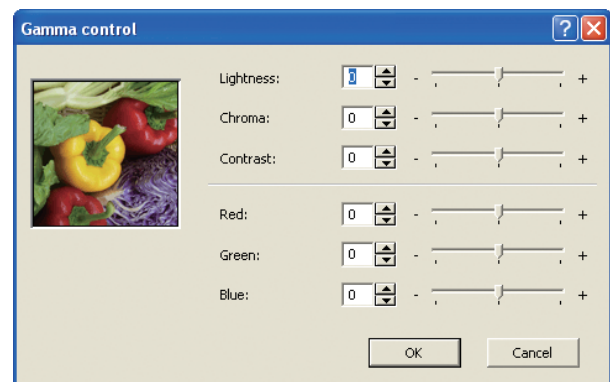

● Screening

Specify the method of halftone processing.

Halftone is a processing method that varies the density and size of ink dots printed on paper to give the appearance of continuous color gradation when only using a limited number of inks.

[Error diffusion]

Express gradation through the density of dots. The higher the density, the darker the gradation. The lower the density, the lighter the gradation.



[Dot process (70 lpi)], [Dot process (100 lpi)]

Express gradation by changing the size of the dots. The larger the dots, the darker the gradation. The smaller the dots, the lighter the gradation. A dot process of 100 lines per inch provides more detailed images.

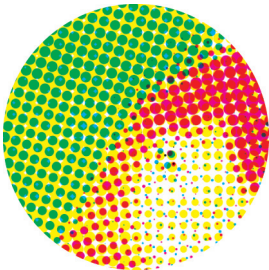

70 lines per inch

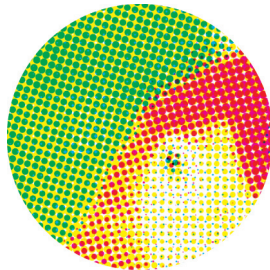

100 lines per inch

(Enlarged image)

● Image quality

Specify the image resolution.

[Standard (300 × 300dpi)]

Suitable for documents and other originals with text.

[Fine (300 × 600dpi)]

Suitable for photos and similar originals.



Printing will take longer if you select [Fine (300 × 600dpi)].

● Print density

Specify the print density.
Select from the following.

[-2] (light), [-1], [0 (Standard)], [+1], [+2] (dark)

● Save/Call setting

The current settings on the printer driver screen can be saved and retrieved later as needed. See "Save/Call setting" (p. 1-11) in "[Basic] Tab" for details.

[Finishing] Tab

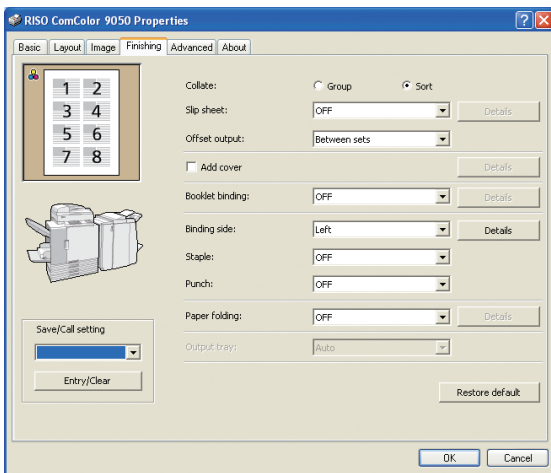

● Collate

Specify the paper sheet output method when printing multiple copies.

Select from the following.

[Group] (Select this to print the specified number of copies of each page.), **[Sort]**



- When you have selected [Group], the following functions are not available.
 - "Staple" (p. 1-21)
 - "Booklet" in "Imposition" (p. 1-12)
 - "Booklet binding" (p. 1-18)
- When selecting [Sort], remove the check mark from the [Collate] check box on the "Print" screen of the application. Printing may not be properly performed when the check box has been selected.

● Slip sheet

Insert a slip sheet between print units when printing multiple copies. You can stamp a number or letter on slip sheets.

Select the unit to insert a slip sheet and click [Details] to display the [Slip sheet] dialog box.

Select the tray for slip sheets and specify the text to stamp.

[OFF]

Slip sheets are not inserted.

[Between sets]

Insert a slip sheet between sets, based on the unit specified in [Collate].

[Between jobs]

Insert a slip sheet between print jobs.

■ Select Sheet Insertion Tray

[Standard tray], **[Feed tray1]**, **[Feed tray2]**, **[Feed tray3]**

■ Number on slip sheet

The text is printed at the bottom center of the sheet (within approx. 5 mm (3/16") of the bottom edge).

[OFF]

Nothing is stamped.

[1, 2, 3 ...]

Numbers are stamped on slip sheets in numerical order (1, 2, 3...). (Up to 9999)

[A B C ...]

Letters are stamped on slip sheets in alphabetical order up to three digits (A, B, C...Z, AB, AC...). (Up to ZZZ)

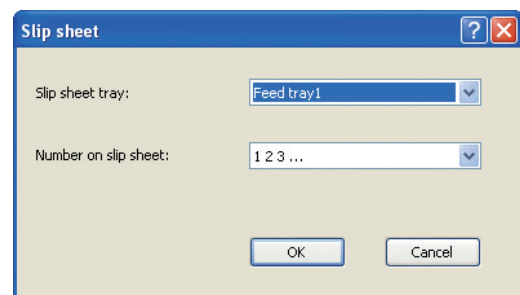

Slip sheets cannot be inserted when the following settings are configured.

- [Paper folding] or [Fold + Staple] in the "Booklet binding" (p. 1-18)
- "Add cover" (p. 1-18)

● Offset output

Stack each print unit shifted apart from one another when printing multiple copies.

[OFF]

Offset output is not performed.

[Between sets]

Stack each print unit, which is specified in [Collate], shifted apart from one another.

[Between jobs]

Stack each print job shifted apart from one another.



- An optional multifunction finisher or face down offset tray is required to use this setting.
- When you have selected [Between sets] or [Between jobs], the following functions are not available.
 - "Booklet binding" (p. 1-18)
 - "Paper folding" (p. 1-22)
 - "Slip sheet" (p. 1-17)
 - "Program" (p. 1-24)
 When configuring program, there is an "Offset output (Program)" setting for [Details].

- This setting has been not available for paper sizes that cannot be output to the face down offset tray or stacking tray. (p. 2-42 "Configuring the Offset Output Setting" in "Copy")



Normally, two-layer offsetting is used. When this setting has been combined with "Staple", three-layer offsetting is used.

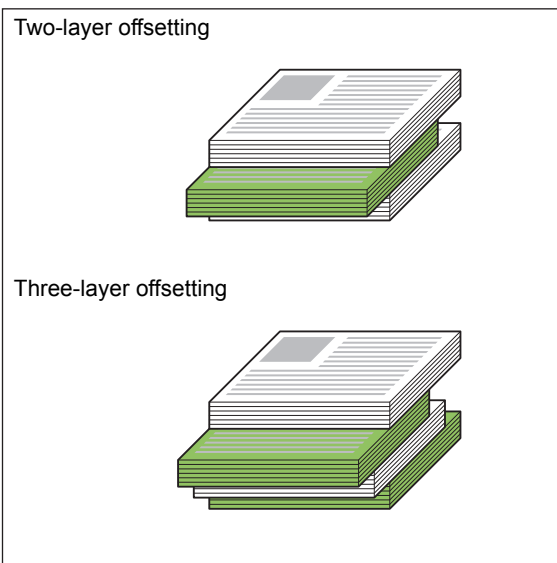

● Add cover

Specify this option to add a front and/or back cover. Paper is added from a specified tray before or after the data to be printed. Specify this option to use colored paper or paper that differs from the pages to be printed.

Select the [Add cover] check box and click [Details] to display the [Details] dialog box. Select the [Put front cover] and [Put back cover] check boxes, and select the trays for the covers.

[Put front cover]

Insert a cover sheet before the first page.

[Put back cover]

Insert a cover sheet after the last page.

[Select front cover tray]/[Select back cover tray]
[Standard tray], [Feed tray1], [Feed tray2], [Feed tray3]

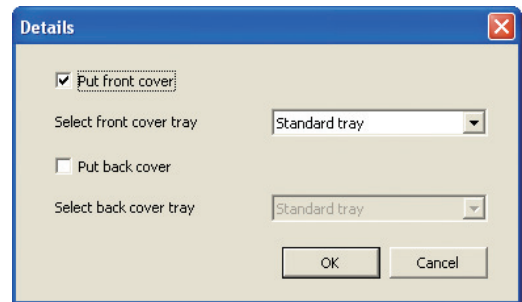

- Specify the trays loaded with paper to be used for the covers.
- When loading preprinted paper, it is recommended that one set be printed to check that the orientation matches that of the other pages to be printed.

● Booklet binding

Perform duplex printing for continuous multiple pages to create a booklet with the paper folded in two. The paper can also be bound in the middle with staples.

Select the booklet binding method and click [Details] to display the [Details] dialog box. Configure the [Separate books], [Center margin], and [Booklet cover] settings.



The optional multifunction finisher is required to use this setting.

[OFF]

Booklet binding is not performed.

[Paper folding]

Printing paper is folded in two.

[Fold + Staple]

Printing paper is folded in two and bound in the middle with staples.



When [Booklet binding] has been set to [Paper folding] or [Fold + Staple], [Imposition] is set to [Booklet] automatically.

■ Separate books

When you have selected [Paper folding] or [Fold + Staple], some restrictions apply to the number of sheets you can fold.

[Paper folding] creates a separate booklet every 5 sheets (20 pages), and [Fold + Staple], a booklet every 15 sheets (60 pages).

When the number of pages exceeds these numbers of sheets, one fold is made every number of sheets indicated above and the sheets are outputted (creating a separate booklet).

The layout order is different depending on whether "middle binding" or "side binding" is performed for the separate stacks. Therefore, select [OFF] or [ON].

[OFF]

Data is imposed to create a book by opening, layering, and then binding the sheets (in the center).

When [OFF] has been selected, the sheets are not stapled even if [Fold + Staple] is selected.

[ON]

Data is imposed to create a book by folding, layering, and then binding the sheets (on the side).

Example: When "OFF" has been selected for [Separate books] and [Paper folding] has been set for a 60-page original

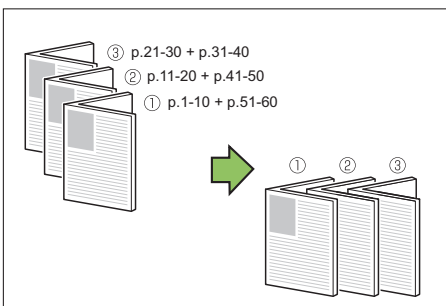

Example: When "ON" has been selected for [Separate books] and [Paper folding] has been set for a 60-page original

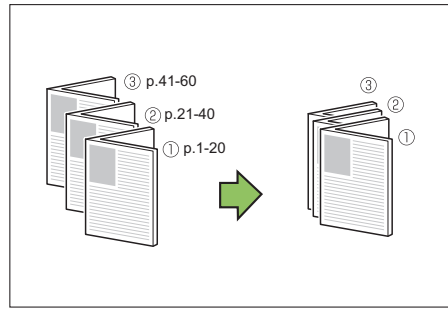

■ Center margin

Specify the width of the center margin. Select the [Add center margin] check box and specify [Width] between 0 mm and 50 mm (1 15/16") (in 1 mm units).

When you have selected the [Auto reduce] check box and the margin width you have specified would cause the printed image not to fit on the sheet, the image is automatically reduced to fit.

■ Booklet cover

Only the cover pages (the first two pages and last two pages) are printed separately. This is useful when printing the covers and main text with separate paper.

[OFF]

Booklet covers are not printed.

[Print cover only]

Only the cover pages are printed.

[Store booklet except cover]

With the [Store booklet except cover] check box selected, you can start printing the main text on the operation panel of the printer after the cover pages are printed. When you select the check box, specify the feed tray for the cover.

[Print except cover]

All pages except for the covers are printed as a booklet.

● Usage example

1 Select [Print cover only] and the [Store booklet except cover] check box.

2 Select the tray with [Feed tray for cover].

Specify the tray in which you will load the printed covers before you start printing the main text in a later step.

3 Send the printing command.

The printer prints only the covers and the remaining data is set to [Waiting] status.

4 Load the printed covers in the tray specified with [Feed tray for cover].

5 On the operation panel of the printer, press [Waiting] in printer mode, and select a job from the list.

6 Press [Print].

The main text is printed, aligned with the covers, and created into a booklet.

Example: When printing a document of 12 pages including the cover pages by using the [Booklet cover] function

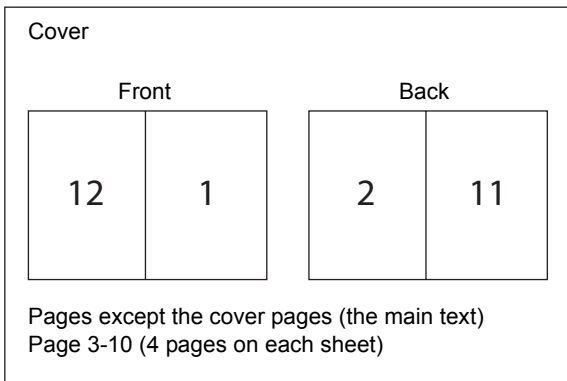

● Binding side

Specify the position for stapling and punching and specify the binding margin.

Select the binding side and click [Details] to display the [Binding side] dialog box.

[Left], [Right], [Upper]

■ Binding margin

Select the [Add side margin] check box and specify the width between 0 mm and 50 mm (1 15/16") (in 1 mm units).

When you have select the [Auto reduce] check box and the margin width you have specified would cause the printed image not to fit on the sheet, the image is automatically reduced to fit.

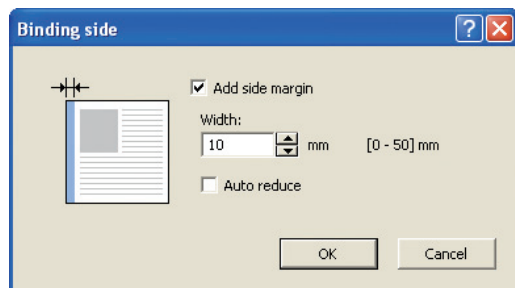
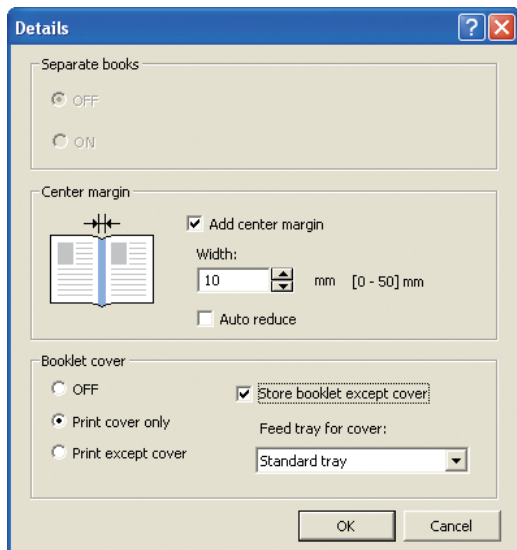
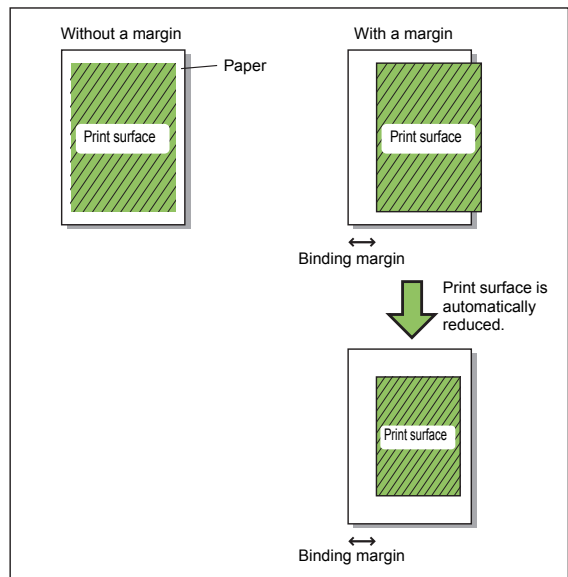

● Staple

Select the stapling method.

- When you select [Left] or [Right] for the binding side, select from the following options.
[OFF], [1 pos.], [2 pos.]
- When you select [Upper] for the binding side, select from the following options.
[OFF], [Left 1], [Right 1], [2 pos.]

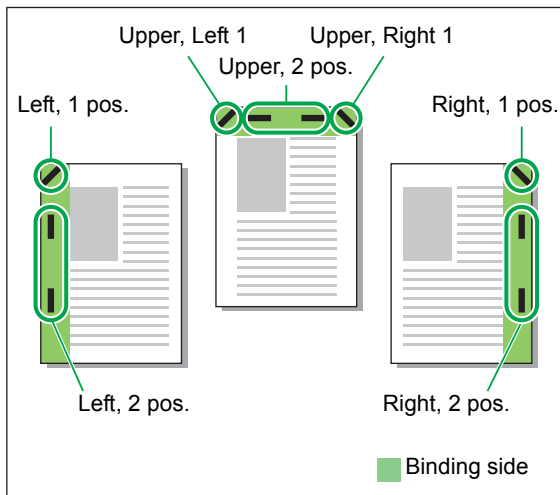

<Types of paper that can be stapled>

- Size and orientation of paper that can be stapled
A3, B4, A4, A4-R, B5-R, Ledger, Legal, Letter, Letter-R, Foolscap and custom size*
* The administrator must register the paper size in advance. Ask your administrator.



- **Paper weight: 52 g/m² - 162 g/m² (14-lb bond - 43-lb bond)**
When the paper weight exceeds 162 g/m² (43-lb bond), only one sheet can be stapled for the cover.

<Number of sheets that can be stapled>

- When using standard size paper
A4 or A4-R: 2 to 100 sheets*
Other standard size paper: 2 to 65 sheets*
- When using non-standard size paper
Paper width of 215 mm (8 7/16") or less: 2 to 100 sheets*
Paper width of 216 mm (8 1/2") or greater: 2 to 65 sheets*



- * When using plain paper and recycled paper
(85 g/m² (23-lb bond))



- An optional multifunction finisher is required to use this setting.
- When you have configured "Staple", be sure to configure [Binding side].
- You cannot use "Staple" and "Booklet binding" at the same time. (p. 1-18 "Booklet binding")



- When printing jobs that exceed the maximum number of sheets that can be stapled, the sheets are outputted to the stacking tray without being stapled.

Punch

Specify the number of holes to be punched.
Punch holes at the position specified in [Binding side].
Select from the following.

[OFF], [2 holes], [3 holes], [4 holes]



The number of holes that can be punched varies depending on the connected finisher.

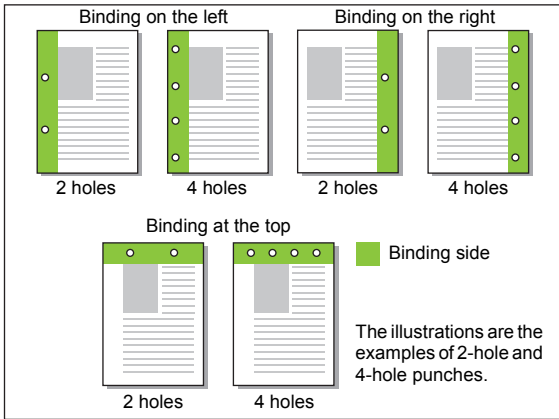

<Types of paper that can be punched>

- Size and orientation of paper that can be punched
 - 2 holes: A3, B4, A4, A4-R, B5-R, Ledger, Legal, Letter, Letter-R
 - 3 holes: A3, B4, A4-R, B5-R, Ledger, Letter-R
 - 4 holes: A3, A4-R, Ledger, Letter-R

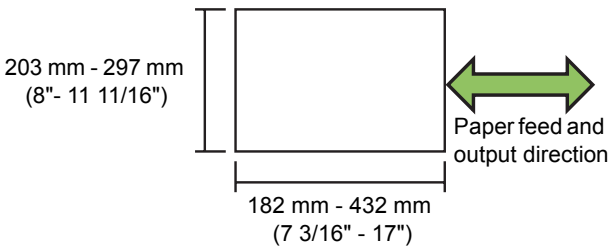

- Paper weight: 52 g/m² - 200 g/m² (14-lb bond - 53-lb bond)



- An optional multifunction finisher is required to use this setting.
- You cannot use "Punch" and "Booklet binding" at the same time. (p. 1-18 "Booklet binding")

<Using with stapling>

You can use punching and stapling together. In this case, the available punching positions are restricted based on the [Staple] setting.

[Staple] setting	Available punching positions
OFF	Left, Upper, Right
Left 2, Left 1	Left
Upper 2, Upper Left 1, Upper Right 1	Upper
Right 2, Upper right 1	Right

Paper folding

Select this when folding paper in two.

Select [2-fold] and click [Details] to display the [Details] dialog box.

Specify the paper fold direction.



The optional multifunction finisher is required to use the "Paper folding" setting.

<Size of Paper that can be Folded>

- A3, B4, A4, Ledger, Legal, Letter, Foolscap and custom size*
 - * The administrator must register the paper size in advance. Ask your administrator.

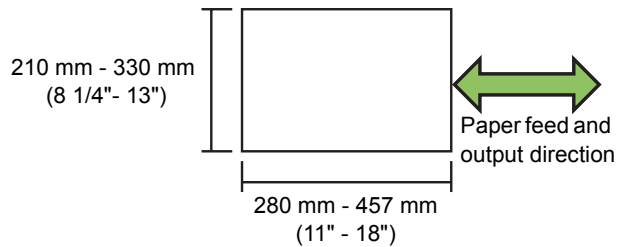

- Paper weight: 60 g/m² - 90 g/m² (16-lb bond - 24-lb bond)

[OFF]

Paper is not folded.

[2-fold]

Each sheet of paper is folded in two.

Fold direction

When you have selected [2-fold], specify the printed surface of the fold direction.

[Print inside]

Fold the paper with the printed surface on the inside.

[Print outside]

Fold the paper with the printed surface on the outside.



When both sides have been printed, the first page is the printed surface.

2-fold

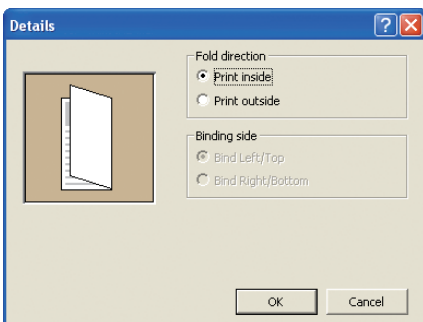
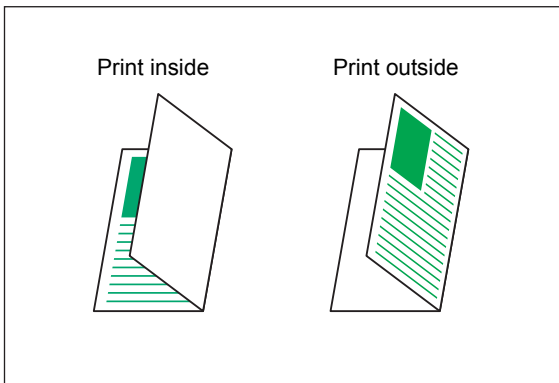

● Output tray

Specify the output tray for printouts. When you have specified [Auto], printouts are outputted to the appropriate tray automatically based on the configured functions. Normally, select [Auto].

- When using an optional stacking tray, select from the following options.
[Auto], [Face down tray], [Auto-ctrl stacking tray/Wide stacking tray]
- When using an optional multifunction finisher, select from the following options.
[Auto], [Face down tray], [Top tray], [Stacking Tray]

! [Output tray] is displayed only when optional output equipment has been connected.

! When the staple, punch, paper folding, or booklet binding settings have been configured, the output trays that can be selected in [Output tray] vary depending on the settings. (p. 1-18 "Booklet binding", p. 1-21 "Staple", p. 1-22 "Punch", p. 1-22 "Paper folding")

● Save/Call setting

The current settings on the printer driver screen can be saved and retrieved later as needed. See "Save/Call setting" (p. 1-11) in "[Basic] tab" for details.

[Advanced] Tab

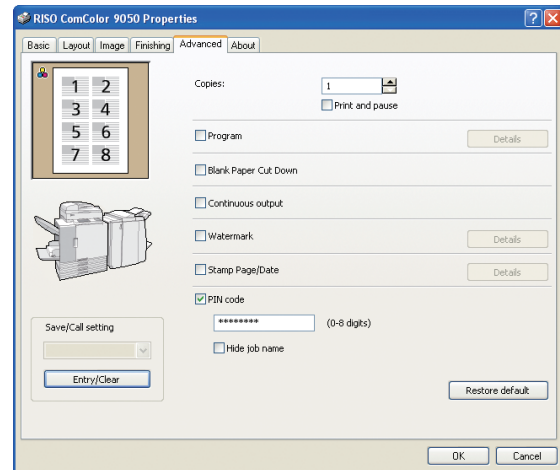

● Copies

Enter the number of copies (1 to 9999) to print.

! When program has been configured, you cannot enter the number of copies.

● Print and pause

When printing an original with a large number of pages or sheets, the first page or first set is printed (except for the specified number of sheets), printing stops to allow you to check the printout, and then printing can be resumed. After you check the printout, press the [START] key on the printer to continue printing. Select the check box to enable this setting.

- ! [Print and pause] proceeds according to the print unit ([Group] or [Sort]) selected with [Collate].
- After checking the printout, you can change the settings on the operation panel of the printer. (p. 4-6 "Changing Settings During Printing" in "Printer")

● Program

This function is useful when distributing different numbers of copies to multiple groups. You can configure up to 60 groups.

Select the [Program] check box and click [Details] to display the [Program] dialog box. Specify the number of copies and sets for each group.

■ Entering the number of copies and sets

Specify up to 9,999 copies and 99 sets per group. For example, to distribute a document to four divisions in an office, you can use [Program] to print by the number of sheets per division with a single operation.

Division	General Affairs 1	General Affairs 2	Accounting	Management
No. of employees	10	6	24	6

To output by group, configure the settings as follows.

Division	General Affairs 1	General Affairs 2	Accounting	Management
Copies × Sets	10 × 1	6 × 1	24 × 1	6 × 1

Even if two divisions have the same number of employees (such as General Affairs 2 and Management), you can configure the settings as follows to output by the number of sheets per division.

Group	01G (General Affairs 1)	02G (General Affairs 2 and Management)	03G (Accounting)
Copies × Sets	10 × 1	6 × 2	24 × 1

■ Collate

Specify whether to output page by page or in sets. **[Group], [Sort]**

■ Slip sheet (Program)

Insert a slip sheet to distinguish separation.

[OFF]

Slip sheets are not inserted.

[Between sets]

Slip sheets are inserted between sets.

[Between groups]

Slip sheets are inserted between groups.

■ Slip sheet tray selection

[Feed tray1], [Feed tray2], [Feed tray3], [Standard tray]

■ Number on slip sheet

When you have selected this check box, numbers are stamped on the slip sheets.

When you have selected [Between sets], the group number and set number are stamped.

When you have selected [Between groups], the group number is stamped.

■ Offset output (Program)

Stack each print unit shifted apart from one another to distinguish separation.

[OFF]

Program offset output is not performed.

[Between sets]

Stack each print unit shifted apart from one another.

[Between groups]

Stack each print group shifted apart from one another.



An optional multifunction finisher or face down offset tray is required to use this setting.

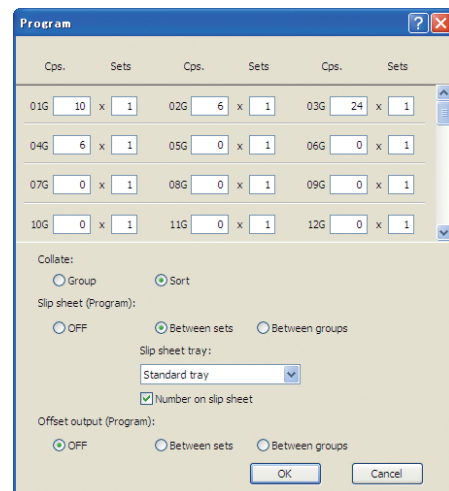

● Blank Paper Cut Down

Print print data except for blank pages.



"Blank pages" means pages that are normally output without anything printed on them. Pages are printed even if they have only a header or footer but no main text.

● Continuous output

Switch the output tray automatically when the tray is full. You must set [Output tray] to [Auto], and [Collate] to [Group] on the [Finishing] tab.



An optional multifunction finisher or stacking tray is required to use this setting.

● Watermark

Add a watermark of the desired size and at the desired position on printouts.

Select the [Watermark] check box and click [Details] to display the [Edit Watermark] dialog box. Select the character string in the Character string list and configure the necessary settings.

The selected settings are immediately applied to the preview image.

■ Applied page

[All pages], [First page only]

■ Character string

You can also add any character strings to use.
[Confidential], [Important], [Circulation], [Reference], [Urgent], [Prohibited to copy]

● Adding a character string

You can also add a character string of up to 63 characters long.

Click [Add] under the list, and enter the character string in the [Add] dialog box.

● Deleting a character string

Select the character string to delete from the list, and click [Clear].

You cannot delete the factory preset character strings (Confidential, Classified, Draft, etc.).



You need to have administrative authority for your computer to add or delete a watermark character string.

■ Character decoration

● Font

Select the font and style.

● Size

Specify the character string size between 1 pt and 600 pt.

● Color

Specify the color of the character string. Click [Custom] to select a color from the color palette of the operating system.

● Transparency

Specify the transparency of the character string. A higher transparency setting means that the print data will be more visible in the background of the watermark character string.

● Frame

Specify the frame surrounding the watermark.

[None], [Circle], [Rectangle], [Double rectangle]

■ Print position

● Character angle

Select the angle of the text. You can also enter the numerical angle of the text.

[Horizontal (0 deg)], [Vertical (90 deg)], [Vertical (270 deg)], [Oblique (45 deg)], [Oblique (315 deg)], [custom (0-360 deg)]

● Print position

Select the print position of the watermark. You can also enter the values for the positions in the X and Y directions.

[Center], [Upper left], [Upper center], [Upper right], [Right center], [Lower right], [Lower center], [Lower left], [Left center], [custom]



You can also use the mouse pointer to adjust the position in the preview image.

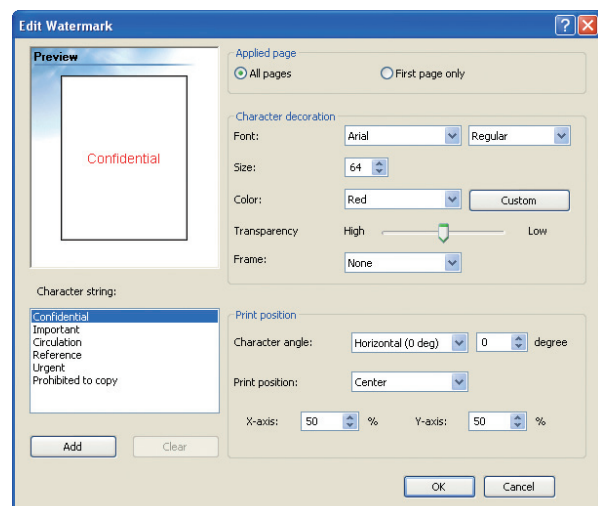

● Stamp Page/Date

Stamp the page number and date on the header or footer.

Select the [Stamp Page/Date] check box and click [Details] to display the [Stamp Page/Date] dialog box. Use the tab screens to configure the settings.



The page number and date cannot be stamped together in the same position.



- When you have selected [Multi-up(Plural)] or [Multi-up (Single)] for "Imposition", even if multiple pages are stamped onto a single sheet, the page numbers are stamped as "1" on the first sheet, "2" on the second sheet, and so on. (p. 1-12 "Imposition")
- When using "Booklet" and "Imposition" or "Booklet" and "Paper folding" at the same time, the page number and date are stamped so that these numbers appear in order once the pages are bound into a booklet.

■ Stamp page

To stamp the number of pages, select [ON] on the [Stamp page] tab screen.

- Stamp position
Select from the following.
[Top L], [Top C], [Top R], [Bottom L], [Bottom C], [Bottom R]
- Transparency
Select the [Transparency] check box to have the page number stamped on top when the stamp area and images overlap.
Remove the check mark from the [Transparency] check box to create a white space by removing images in the stamp area, and then stamp the page number in that white space.
- Start number
Enter the stamp start number (1 to 9).

- Stamp start page

Enter the stamp start page (1 to 9).

To not stamp on the cover, set "Stamp start page" to "2". Set this to "3" in some cases such as duplex printing.

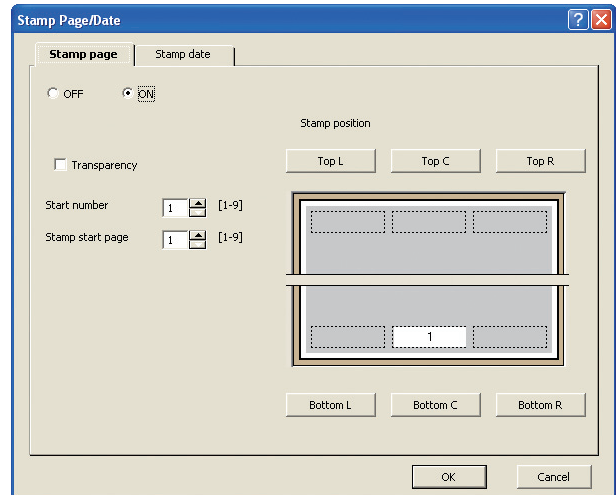

■ Stamp date

To stamp the date, select [ON] on the [Stamp date] tab screen.

- Stamp position
[Top L], [Top C], [Top R], [Bottom L], [Bottom C], [Bottom R]
- Transparency
Select the [Transparency] check box to have the date stamped on top when the stamp area and images overlap.
Remove the check mark from the [Transparency] check box to create a white space by removing images in the stamp area, and then stamp the date in that white space.
- Applied page
[All pages], [First page only]

- Stamped date

- [Today's date]**

- Stamp the date based on the date information of the computer.

- [Specified date]**

- Enter up to 12 numeric characters in the text box.

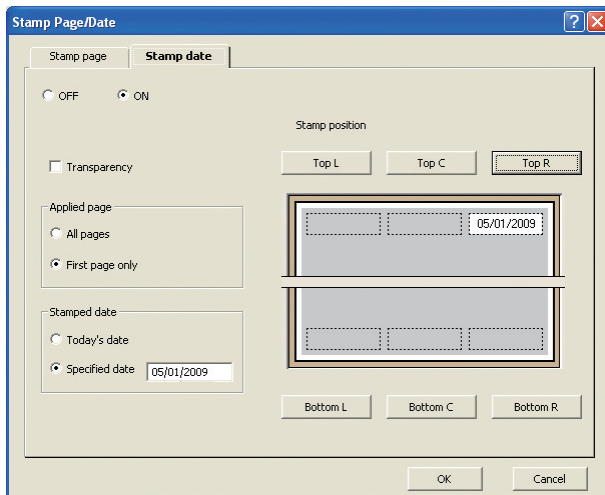

- PIN code

You can set a PIN code when, for example, printing a document you do not want others to view.

Jobs with a PIN code are set to [Waiting] status. To print, enter the PIN code using the operation panel of the printer. (p. 4-7 "[Waiting] Screen" in "Printer")

Select the [PIN code] check box and enter a PIN code of up to eight digits. When you have selected the [Hide job name] check box, the job name is displayed with asterisks "*" on the operation panel of the printer and on the RISO Console.



Manage the PIN code so as not to forget it. Users without administrative authority cannot delete jobs from a list for which the PIN code is unknown. Ask the administrator to delete these jobs.

- Save/Call setting

The current settings on the printer driver screen can be saved and retrieved later as needed. See "Save/Call setting" (p. 1-11) in "[Basic] tab" for details.

[About] Tab

Check the version and color profile of the printer driver and the model name of the printer.

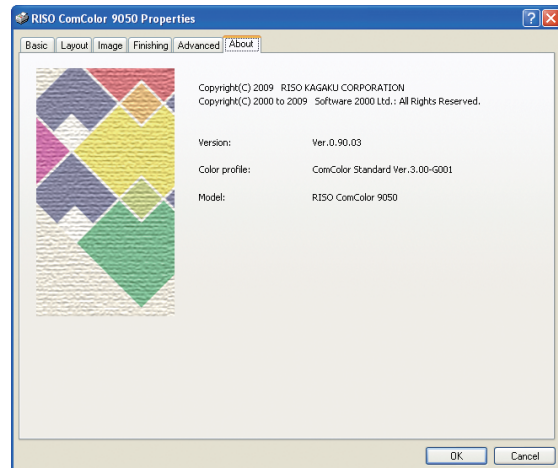

Environment Settings

This section describes how to configure the environment settings, including the configuration of optional equipment connected to the machine.

When using the printer driver for the first time or adding optional equipment to the machine, configure the printer configuration.

[Environment] Tab

To display the [Environment] tab, on your computer click [Start] → [Control Panel] → [Printers and Faxes], and open the [Properties] dialog box of the printer.

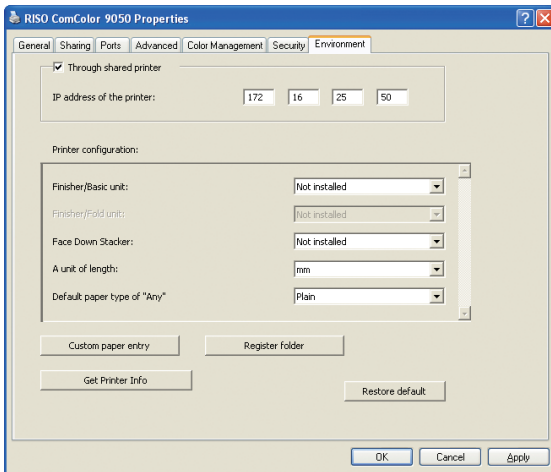

Clicking [Restore default] restores all settings on the tab to their default values.

● Through shared printer

Select this option to share the printer driver of the server PC to use this machine.

Select the check box and enter the machine's IP address in the [IP address of the printer] field. Ask your administrator for the IP address, as needed.

● Printer configuration

Normally, click [Get Printer Info] to obtain the optional equipment configuration information from the printer automatically. The information obtained from the machine is displayed in [Printer configuration]. The obtained information can also be changed manually.



The information displayed on the screen varies depending on the optional equipment connected.

■ Configuring the Printer Configuration Automatically

Click [Get Printer Info] and [Apply] to obtain the optional equipment configuration information from the printer and display it in [Printer configuration].

■ Configuring the Printer Configuration Manually

Specify the following settings manually.

- Finisher/Basic unit
Select the type of optional output equipment connected to the machine.
- Face Down Stacker
Select whether there is a face down offset tray.
- A unit of length
Select whether to display units of length in millimeters or inches.
- Default paper type of "Any"
Select the color profile to use when [Paper type] is set to "Any" on the [Basic] tab of the printer driver screen.



The machine changes the color profile according to the paper type. (p. 1-10 "Paper type") Even if a paper type is not specified, you must select one of the color profiles. Make your selection based on the administrator's recommendation.

● Custom paper entry

Register up to 30 non-standard paper sizes. The sizes registered here are displayed in [Original size] and [Paper size].

■ Configuring the Paper Size Automatically

You can use this option when the paper size is already registered in the printer.

1 Click [Custom paper entry].

The [Custom paper entry] dialog box is displayed.

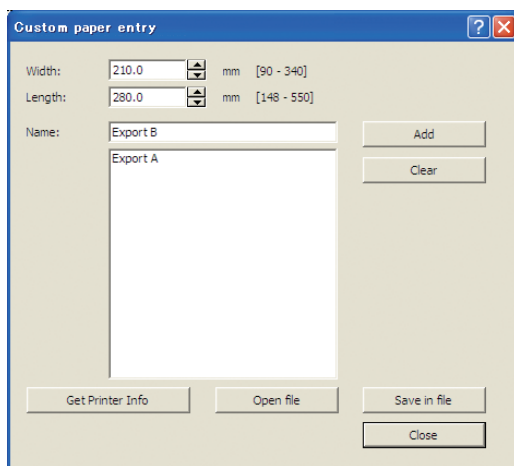

2 Click [Get Printer Info].

The information of the paper size registered in the printer is displayed.

3 Click [Close].

The paper size information is saved.

■ Configuring the Paper Size Manually

1 Click [Custom paper entry].

The [Custom paper entry] dialog box is displayed.

2 Enter the paper width and length.

Specify a width between 90 mm - 340 mm (3 9/16"-13 3/8").

Specify a length between 148 mm - 550 mm (5 13/16"-21 5/8").

- The size of paper that can be fed into the machine is different when a multifunction finisher has been connected. (p. 6-9 "Multifunction Finisher (Optional)" in "Specifications")

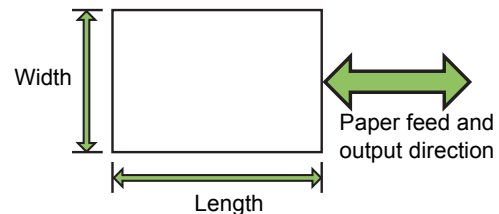

3 Enter a name for the paper size.

Enter a name of up to 32 characters long.

4 Click [Add] to register the paper size.

5 Click [Close].

The paper size information is saved.

■ Saving the Paper Size to a Computer

You can save the registered paper size to a computer. It is useful to save settings to a computer when, for example, you want to share the registered paper size among multiple users or reinstall the printer driver.

- 1 Click [Custom paper entry].**
The [Custom paper entry] dialog box is displayed.
- 2 Select the paper size to save from the list box.**
- 3 Click [Save in file].**
- 4 Specify the destination folder and file name.**
- 5 Click [Save].**
The selected paper size is saved.

■ Reading a Paper Size from a Computer

You can read and use a paper size saved to a computer.

- 1 Click [Custom paper entry].**
The [Custom paper entry] dialog box is displayed.
- 2 Click [Open file].**
- 3 Select the file with the paper size setting on the computer.**
- 4 Click [Open].**
The read paper sizes are displayed in the list on the [Custom paper entry] dialog box.

■ Deleting a Paper Size

- 1 Click [Custom paper entry].**
The [Custom paper entry] dialog box is displayed.
- 2 Select the paper size to delete from the list box on the [Custom paper entry] dialog box.**
- 3 Click [Clear].**
The selected paper size is deleted.

● Register folder

Register destination folders for print data on the printer driver. The shared folders and personal folders registered here are displayed as print data destination folders in the [Destination] in [Output] on the [Basic] tab of the printer driver screen. (p. 1-10 "Output and Destination")



- Folders must be registered to the printer in advance.
- When the information for register folders cannot be obtained from the printer, the shared folders are displayed as "Shared folder 1" to "Shared folder 30".
- The [Use Personal folder] check box can be selected only when the administrator has configured the login setting for printer mode to "Required".

■ Configuring the Register Folder

1 Click [Register folder].

The [Register folder] dialog box is displayed.

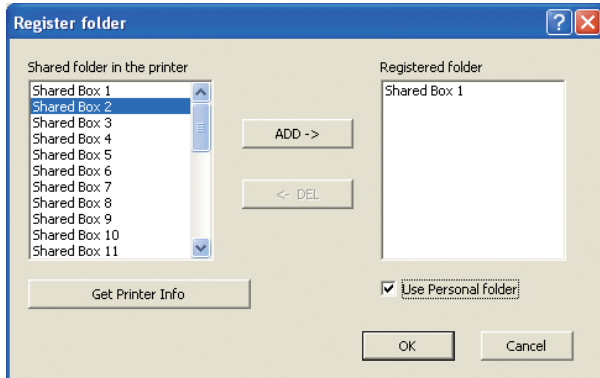

2 Click [Get Printer Info].

The information of the shared folder registered in the printer is displayed in [Shared folder in the printer].

3 Select the folder to add to [Registered folder] and click [Add].

4 Configure the personal folder.

For personal folders, select the [Use Personal folder] check box.

5 Click [OK].

- To cancel the settings, click [Cancel].



2



Copy

Overview of Copy Operations

You can use the machine as a color copier by connecting the optional scanner.

You can save scanned data in folders for printing as necessary.

If you connect an optional multifunction finisher, you can create a booklet or fold, staple, or punch the printed paper.

Procedure

The copy workflow is as follows.

- 1 Load the original
- 2 Select copy mode
- 3 Configure the functions
- 4 Specify the number of copies
- 5 Press the [START] key

1 Loading Originals

For information on the types of originals that can be loaded, see "Originals" in the "Safety Information".

In the ADF

1 Load the original in the ADF.

Align the originals and place them face up.

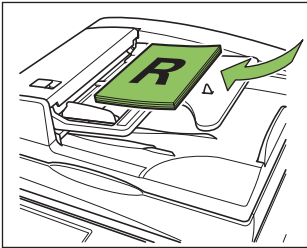

2 Slide the original guides to match the width of the originals.

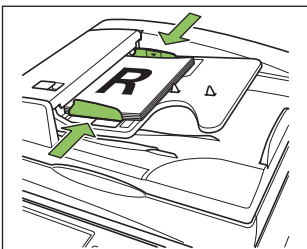

On the Platen Glass

Open the original cover and place the original on the glass surface.

1 Open the original cover.

2 Place the original.

Place the original face down on the glass. Align the corner of the original with the upper-left corner of the glass.

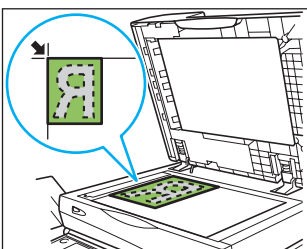

3 Close the original cover.

Open and close the original cover gently.

2 Selecting Copy Mode

1 Press [Copy] on the mode screen.

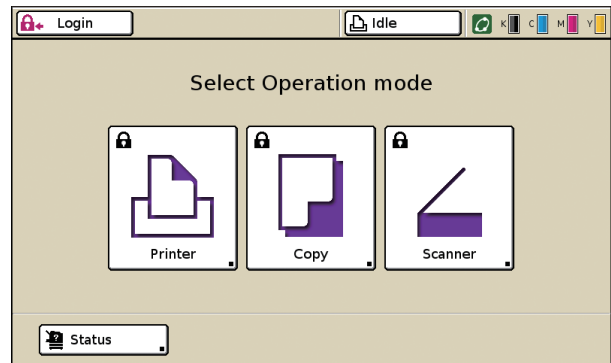

The copy mode screen is displayed.

- Press the MODE key to display the mode screen.
- You may have to login before the copy mode screen is displayed. (p. 13 "Logging In")
- Buttons for modes that the current user is not authorized to use are grayed out.
- When using an optional IC card reader, you can login by holding the IC card over the card reader.
- The displayed mode buttons vary depending on the optional equipment connected.

● 3 Configuring the Functions

Specify the copy finishing settings.

For information on the functions that can be configured, see "List of Settings" (p. 2-6).

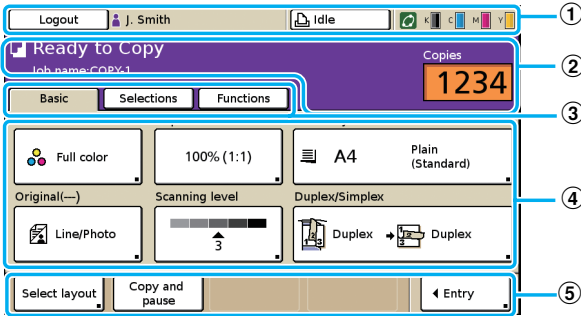

① Status bar

Displays the login or logout button, user name, machine status (Printer Status Button), and remaining ink indicator.

② Message area

Displays the job name, number of copies, and any messages.

③ Screen selection buttons

Displays the [Basic], [Selections], or [Functions] screen when touched.

Use the [Basic] screen to configure the basic copy settings.

The [Selections] screen displays the frequently used functions.

Use the [Functions] screen to configure the copy functions.

④ Function configuration buttons

Display the current settings. Press a button to display the screen for configuring that function.

⑤ Direct access area

Displays the frequently used function buttons.

● 4 Specify the Number of Copies

You can specify up to 9,999 copies using the numeric keys.

The specified number of copies is displayed at the top right of the screen.

- To clear the fields, press the [Clear] key.



● 5 Press the [START] Key

The [Copying in progress] screen is displayed, and copying of the original starts.

The current status, including the number of copied pages, is displayed on the screen.

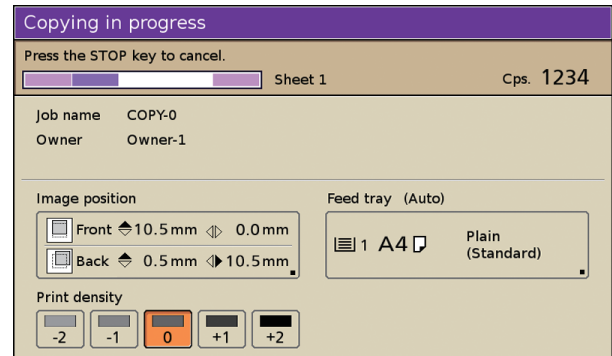

- When pressing the [START] key while printing another job, the message "Processing a job. Printing starts automatically." is displayed. Copying starts as processing is completed.
- When copying has been completed, the copy mode screen is displayed.



Pressing the [Interrupt] key pauses printing of the current job and enables you to perform another copy.

■ When using the platen glass to scan an original with several pages

After scanning a sheet of an original, the confirmation screen is displayed. When there is another page of the original to scan, load the next page and press [Scan].

After all originals are scanned, press [Print].

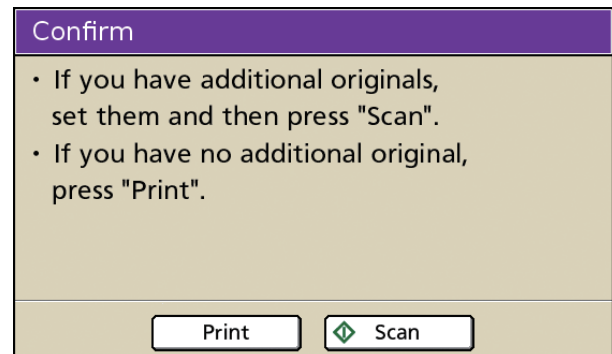

- If you have additional originals, set them and then press "Scan".
- If you have no additional original, press "Print".

■ Loading the Next Copy Job

During copying, once scanning of the original has been completed, you can begin scanning of another original.

- 1 Press [Close] while the [Copying in progress] screen is displayed.
- 2 Load the next original and press the [START] key.

The message "Processing a job. Printing starts automatically." is displayed and the original is copied as the next job.

■ Canceling Copying

- 1 Press the [STOP] key.

The [Confirm] screen is displayed.

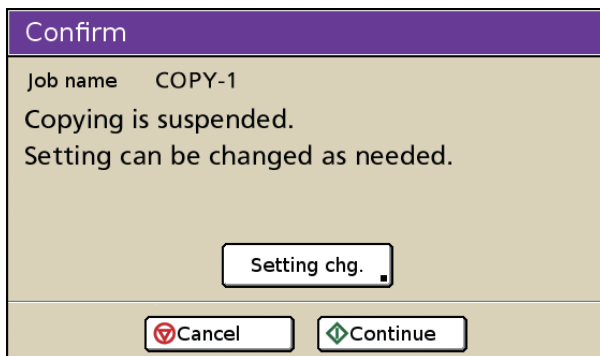

- 2 Press [Cancel].

Copying is canceled.

- To continue copying, press [Continue].
- To change the settings, press [Setting chg.]. When changing [Image position] and other settings, see "Image Position" (p. 4-12) in "Printer".

■ Changing the Settings During Copying

- 1 Press the [STOP] key.

The [Confirm] screen is displayed.

- 2 Press [Setting chg.].

The [Suspending] screen is displayed.

3 Change Settings.

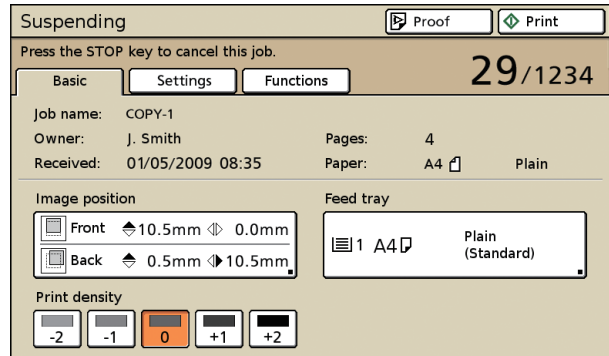

You can modify the following settings.

- Image position (p. 4-12 "Image Position" in "Printer")
- Feed tray (p. 2-9 "Feed tray" in "Copy")
- Print density (p. 4-13 "Print density" in "Printer")



- To confirm the settings of the job, press [Settings]. Press [▲] and [▼] to scroll the list.
- To configure the following settings, press [Functions].
 - "Paper guide control" (p. 2-50)
 - "Jump wing control" (p. 2-51)
 - "Head cleaning" (p. 2-51)
 - "Front doors release" (p. 2-52)

4 Press [Proof] or [Print].

- When you press [Proof]

The page that was being printed when the [STOP] key was pressed is printed using the new settings. If the print result is satisfactory, press [Print].
- When you press [Print]

Copying of the job with changed settings starts.

List of Settings

The following is a list of copy mode settings.



- The settings displayed on the screen vary depending on the selected item and how the administrator has configured the settings.
- An option setting is displayed only when optional equipment required for that setting has been connected.

	Setting	Description	See
[Basic]	Color mode	Select color or monochrome printing.	p. 2-8
	Reproduction size	Use this to reduce or enlarge the copied image.	p. 2-9
	Feed tray	Change the feed tray, paper type, and feed control settings according to the paper to be copied.	p. 2-9
	Original	Select the original type to perform the appropriate image processing and print the scanned data.	p. 2-12
	Scanning level	Adjust the scanning density of originals.	p. 2-13
	Duplex/Simplex	Specify the sides of the original to be read and the sides of the paper to be printed on.	p. 2-14
	Direct Access entry* ¹	Up to 4 frequently used functions can be registered to the direct access area.	p. 2-17
[Selections]	Selections entry* ¹	Up to 16 frequently used functions can be registered to the selections screen.	p. 2-17
[Functions]	Check setting	Confirm the current settings and print the settings information.	p. 2-18
	Save/Call setting	Up to 10 frequently used settings can be registered.	p. 2-19
	Select layout	Set various finishing settings by selecting an output image.	p. 2-22
	Copy and pause	To check the printing result when copying a large number of copies, the machine stops after printing one set.	p. 2-23
	Additional copies	Print one or more copies of previously copied original data.	p. 2-24
	Save to folder	Save scanned originals as data to the machine. You can retrieve the data and print it when needed.	p. 2-24
	Save to archive	Save scanned originals as data to an external controller. You can retrieve the data and print it when needed. (When using the optional ComColorExpress IS900C)	p. 2-26
	ADF scan & pause	Copy all originals together, even when copying a large quantity of originals that cannot be loaded at one time in the ADF.	p. 2-27
	Scanning size	Specify the scanning size of the original.	p. 2-27
	Mixed size original* ² * ³	Specify this option when the original has multiple sizes.	p. 2-28
	Book shadow erase	Erase shadows that appear in the center of copies when an open book is copied.	p. 2-29
	Multi-up	Specify Multi-up(Plural) (arranges continuous pages on one sheet) and Multi-up(Single) (arranges multiple copies of one page on one sheet) copying.	p. 2-30
	Stamp Page/Date	Stamp the page number and date on the header or footer.	p. 2-31
Image quality	Specify the resolution for scanning originals.	p. 2-33	

	Setting	Description	See
[Functions]	Gamma control	Adjust the color balance (CMYK) of scanned data.	p. 2-34
	Image control	Specify the image processing of the original.	p. 2-35
	Base color level	Make the background color (base color) lighter so that the text is easier to read.	p. 2-35
	Program	Specify this when the number of required copies varies by group (such as corporate division or classes). You can quickly print exactly the number of copies of the number of sets you need.	p. 2-36
	Add cover* ²	Specify this to add front and back covers to the front and back of the printout.	p. 2-40
	Collate/slip sheet* ²	Specify the type of collation and slip sheet.	p. 2-41
	Auto-Rotate	Rotate the image 90 degrees automatically when the orientation of the original and paper do not match.	p. 2-43
	Staple/Punch* ²	Specify the stapling and punching settings. (When using the optional multifunction finisher)	p. 2-43
	Paper folding* ²	Select this when folding paper in two. (When using the optional multifunction finisher)	p. 2-45
	Booklet* ²	Specify the imposition and paper folding when creating a booklet. (When using the optional multifunction finisher)	p. 2-47
	Output tray	Specify the output tray for the copies and continuous output settings. (When using the optional multifunction finisher or stacking tray)	p. 2-49
	Paper guide control	Adjust the position of the paper guides of the RISO auto-control stacking tray. (When using the optional RISO auto-control stacking tray)	p. 2-50
	Jump wing control	Adjust the position of the jump wing. (When using the optional stacking tray)	p. 2-51
	Head cleaning	Clean the ink heads.	p. 2-51
Front doors release	Release the front door lock.	p. 2-52	

*1 Depending on the administrator setting, this button may not be displayed.

*2 This function is not available for ComColor 7010/7010R/3010/3010R.

*3 This function is not available for ComColor 3050/3050R.

Basic Settings

This section describes the copy functions that are configured with the [Basic] screen.

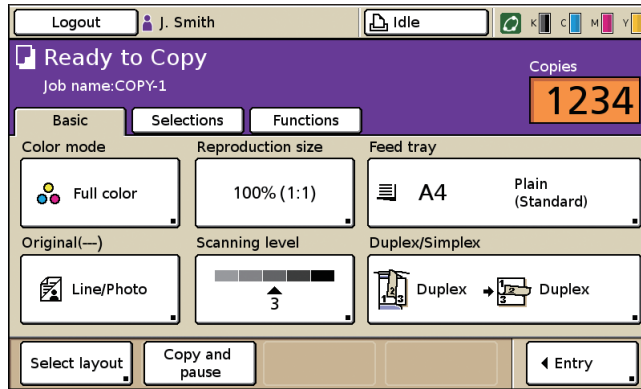

Color mode

Select color or monochrome printing.

[Auto]

Determine the color of the original automatically and copies in color (cyan, magenta, yellow, and black) or black and white.

[Full color]

Convert and copy the data into four colors (cyan, magenta, yellow, and black).

[Black]

Copy in one color (black) regardless of the color of the original.

[Cyan]

Copy in one color (cyan) regardless of the color of the original.

[Magenta]

Copy in one color (magenta) regardless of the color of the original.



"Auto" and "Full color" cannot be selected when the administrator has restricted color copying.

1 Press [Color mode].

The [Color mode] screen is displayed.

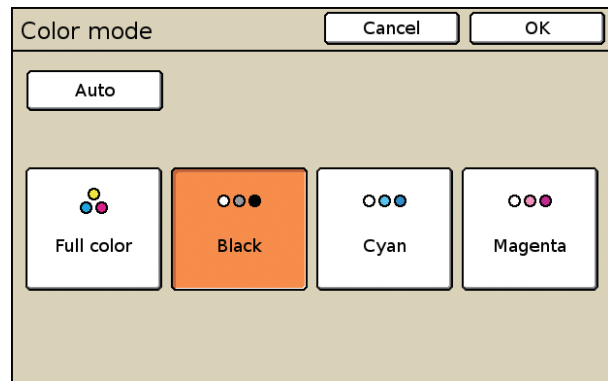

2 Select the color mode.

3 Press [OK].

The settings are confirmed and the previous screen is displayed.

Reproduction size

Copy at the specified reproduction ratio.

[Auto]

The reproduction ratio is set automatically based on the original size and paper size.

[100% (1:1)]

Copy at 100%.

Preset Scaling

Copy by enlarging or reducing a standard size original to another standard size paper.

[Zoom]

Specify the reproduction ratio to enlarge or reduce the original when copying. Specify the reproduction ratio from 50% to 200%.



When you have selected "Auto", the reproduction size is set automatically to match the paper size. (p. 2-9 "Feed tray")



1 Press [Reproduction size].

The [Reproduction size] screen is displayed.

Reproduction size			Cancel	OK
Auto	61% A3->B5	116% B4->A3 B5->A4		
100% (1:1)	71% A3->A4 B4->B5	122% A4->B4 A5->B5		
A4 -> Card	82% B4->A4 B5->A5	141% A4->A3 B5->B4		
B5 -> Card	87% A3->B4 A4->B5	163% B5->A3		
Numerical input (Numeric keys available)				
<input type="text"/>	▲	▼		
(50-200%)				



2 Specify the reproduction ratio.

To enter any number, press the empty field at the lower left and enter the number using [▲] and [▼] or the numeric keys.



3 Press [OK].

The settings are confirmed and the previous screen is displayed.

Feed tray

Select the feed tray.

You can also change the tray settings (paper size, paper type, and tray selection).

Selecting the Feed Tray

[Auto]

The feed tray is selected automatically from the tray selection.

Feed tray selection

When using a paper size that is different from the original size, or to use a tray set [Manual] in [Tray selection], select the feed tray.



When [Tray selection] has been set to [Manual] for all feed trays, [Auto] cannot be selected.



When [Mixed size original] has been specified, only [Auto] can be selected. (p. 2-28 "Mixed size original")



1 Press [Feed tray].

The [Feed tray] screen is displayed.

The settings for each tray are displayed.

Feed tray				Cancel	OK
Auto					
Paper size	Paper type	Feed ctrl.	Tray selection		
A4 210x297mm	Plain	Standard	Manual		
1 A3 297x420mm	Plain	Standard	Auto		
2 A4 297x210mm	Plain	Standard	Auto		
3 B5 182x257mm	Plain	Standard	Auto		
Change				Setting of selected tray can be changed.	

- The icon to the left of the tray button indicates the amount of paper remaining in the tray. When (standard tray:) is displayed, this indicates that there is no paper. Load paper.

2 Select the feed tray.

3 Press [OK].

The settings are confirmed and the previous screen is displayed.

● Changing the Feed Tray Setting

To change the tray setting, select a feed tray and press [Change].
When changing the paper loaded in a tray, be sure to change the [Feed tray] settings.

■ Paper size

[Auto]

Standard-size paper is detected automatically and its size is displayed on the [Feed tray] screen.

Paper size selection

The non-standard paper sizes registered by the administrator in advance are displayed. For the standard tray only, the factory presets card and envelope sizes.

! If you use paper with a size not displayed, you cannot obtain the correct printing result. In addition, the inside of the machine may become dirty with ink. Register non-standard paper before using. For details, ask your administrator.

✎ When using a tray loaded with special paper, it is recommended that you set [Tray selection] to [Manual]. (p. 2-12 "Configuring the [Tray selection] Setting")

1 Press [Feed tray].

2 Select the feed tray.

3 Press [Change].

The [Paper size] screen for the selected feed tray is displayed.

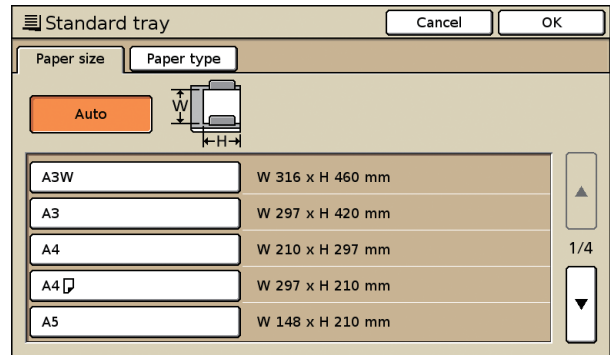

4 Select the paper size to use.

To configure the paper type, go to Step 2 in "Paper type".

5 Press [OK].

The settings are confirmed and the [Feed tray] screen is displayed.

■ Paper type

Select from the following.

[Plain], [IJ paper], [Matt coated], [High-quality], [Card-IJ]

- The displayed paper types vary depending on the selected paper tray.
- The machine selects the color profile according to the selected paper type. (When you change the paper type, the printing result changes.) If the printing result is not what you expected, change the paper type.

1 Display the [Paper size] screen.

Follow Steps 1 to 3 in "Changing the Feed Tray Setting".

2 Press [Paper type].

The [Paper type] screen is displayed.

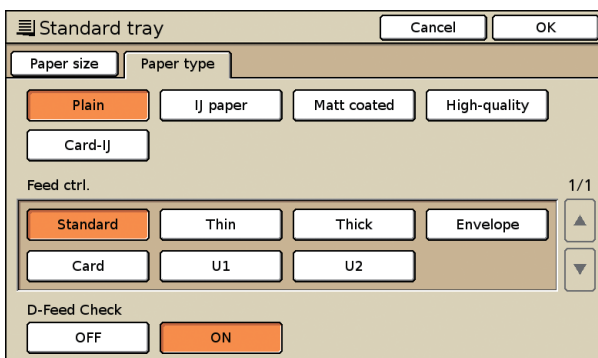

3 Select the paper type.

When the paper thickness changes, go to Step 3 in "Feed ctrl.".

4 Press [OK].

The settings are confirmed and the previous screen is displayed.

■ Feed ctrl.

The timing for paper feeding is adjusted to suit the paper thickness. Select from the following.

[Standard], [Thin], [Thick], [Envelope], [Card]

- When you have selected [Envelope] for the standard tray, duplex printing cannot be performed from the standard tray.

- The displayed settings vary depending on the selected feed tray.

1 Display the [Paper size] screen.

Follow Steps 1 to 3 in "Changing the Feed Tray Setting".

2 Press [Paper type].

The [Paper type] screen is displayed.

3 Select the paper feed setting.

- When using special paper, you can specify the adjustment values U1 to U5 in advance and add settings. For more information, consult your dealer (or authorized service representative).

4 Press [OK].

The settings are confirmed and the previous screen is displayed.

■ D-Feed Check

Select whether to detect the feeding of multiple sheets of paper. Normally, select [ON]. This function uses light permeability to detect multiple sheets of paper, so when using paper printed on the back or paper with a dark base color or envelopes, select [OFF].

[ON], [OFF]

1 Display the [Paper size] screen.

Follow Steps 1 to 3 in "Changing the Feed Tray Setting".

2 Press [Paper type].

The [Paper type] screen is displayed.

3 Press [ON] for D-Feed Check.

4 Press [OK].

The settings are confirmed and the previous screen is displayed.

● Configuring the [Tray selection] Setting

When you have selected [Auto] on the [Feed tray] screen, the machine automatically selects the feed tray to use from among the feed trays with [Tray selection] set to [Auto].



When loading special paper (high-quality paper, colored paper, thick paper, letterhead, etc.), you can prevent the unnecessary use of special paper by setting [Tray selection] to [Manual].

1 Press [Feed tray].

The [Feed tray] screen is displayed.

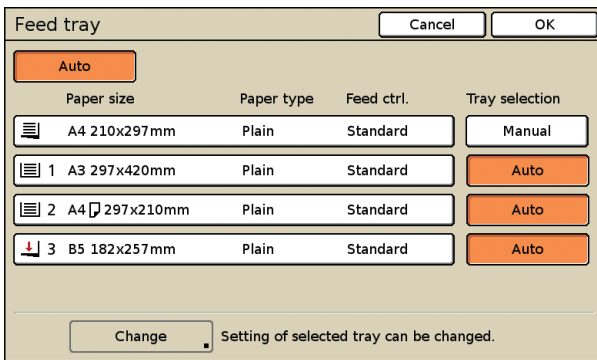

2 Configure the [Tray selection] setting.

The button switches between [Auto] and [Manual] each time it is pressed.

3 Press [OK].

The settings are confirmed and the previous screen is displayed.

Original

Select the type of original for the appropriate image processing and then printing.

[Line/Photo]

Select this when the original has both text and photos.

[Line]

Select this when the original has text or illustrations.

[Photo]

Select this when the original has photos.

[Map/Pencil]

Select this for originals with a lot of subtle colors or fine lines, such as a map, or for originals with pencil drawings.

When you have selected [Line/Photo], [Photo], or [Map/Pencil], specify the dot process.

[OFF]

Dot process is not performed.

[70 lpi]

Reproduce photos with a halftone dot of 70 lpi.

[100 lpi]

Reproduce photos with a halftone dot of 100 lpi.

1 Press [Original].

The [Original] screen is displayed.

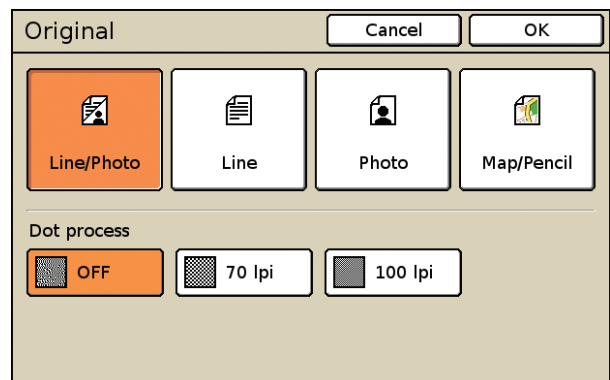

2 Select the original type.

3 When you select [Line/Photo], [Photo], or [Map/Pencil], specify the dot processing.

4 Press [OK].

The settings are confirmed and the previous screen is displayed.

Scanning level

You can adjust the scanning density of originals. Select from the following.

[1] - [5]

The lower the setting (toward [1]), the lighter the density. The higher the setting (toward [5]), the darker the density.

1 Press [Scanning level].

The [Scanning level] screen is displayed.

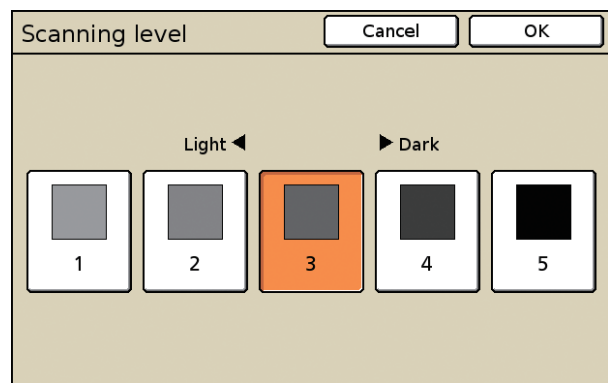

2 Select the scanning level.

3 Press [OK].

The settings are confirmed and the previous screen is displayed.



You can make the background color (base color) lighter so that the text is easier to read when copying text originals with a background color or colored paper. (p. 2-35 "Base color level")

Duplex/Simplex

Specify the sides of the original to be read and the sides of the paper to be printed on. The current settings (the original scanning side and output) are displayed on the screen.

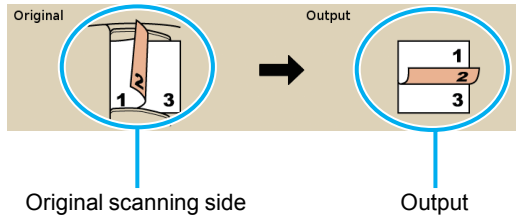

Original Scanning Side

[Simplex], [Duplex]

Original Paging Direction

When the original is two-sided, select how pages of the original are turned.

[Left / Right], [Top / Bottom]

Original orientation

[Top side up]

Select this when loading the original with the top of the original facing toward the back of the platen glass or the ADF.

[Top side left]

Select this when loading the original with the top of the original facing toward the left of the platen glass or the ADF.

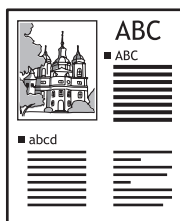

Top side up

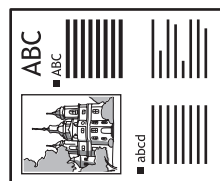

Top side left

Output

Select the layout of the printout.

[Simplex], [Duplex]

Output Paging Direction

When copying both sides of the original, select how pages are turned.

[Left / Right], [Top / Bottom]

Duplex Copying

1 Press [Duplex/Simplex].

The [Duplex/Simplex] screen is displayed.

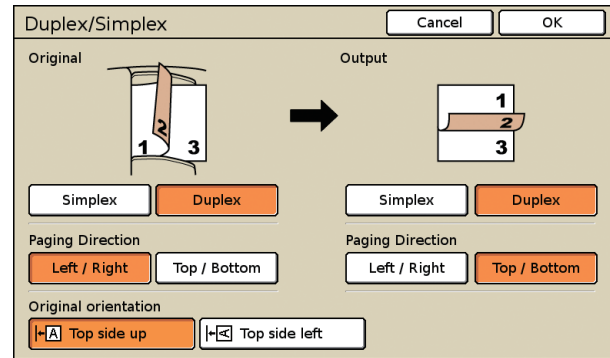

2 Specify the sides of the original to scan.

- When you have selected you select [Duplex], select how pages of the original are turned.



Buttons that do not need to be configured are grayed out.

3 Select the original orientation.

4 In [Output], press [Duplex].

5 In [Output], select the [Paging Direction] setting.

6 Press [OK].

The settings are confirmed and the previous screen is displayed.

● Simplex Copying of a Two-sided Original

Load the original in the ADF.

- 1 Press [Duplex/Simplex].
- 2 In [Original], press [Duplex].
- 3 In [Original], select the [Paging Direction] setting.
- 4 Select the original orientation.
- 5 In [Output], press [Simplex].
- 6 Press [OK].

The settings are confirmed and the previous screen is displayed.

Direct Access/Selections entry

You can register frequently used functions to the direct access area of the [Basic] screen or to the [Selections] screen.



When login is not necessary, you cannot register functions to the direct access area or the [Selections] screen. In this case, the functions configured by the administrator are displayed in the direct access area and the [Selections] screen.

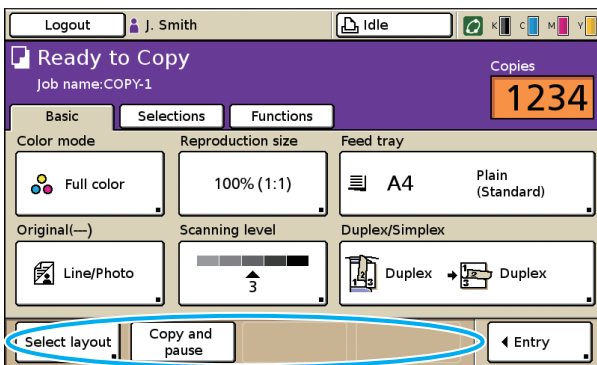

Direct access area of the [Basic] screen

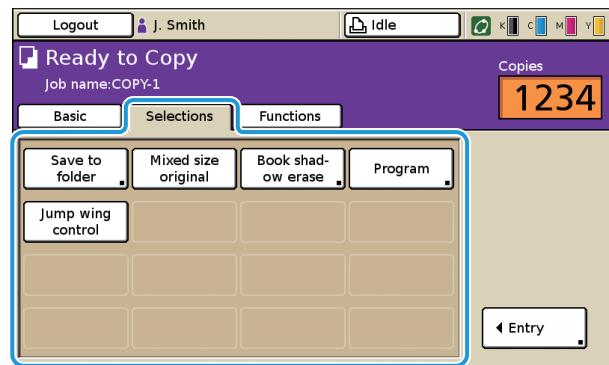

[Selections] screen

The following are the functions that can be registered to the direct access area in the [Basic] or [Selections] screen.

- "Check setting" (p. 2-18)
- "Save/Call setting" (p. 2-19)
- "Select layout" (p. 2-22)
- "Copy and pause" (p. 2-23)
- "Additional copies" (p. 2-24)
- "Save to folder" (p. 2-24)
- "Save to archive" (p. 2-26)
- "ADF scan & pause" (p. 2-27)
- "Scanning size" (p. 2-27)
- "Mixed size original" (p. 2-28)
- "Book shadow erase" (p. 2-29)
- "Multi-up" (p. 2-30)
- "Stamp Page/Date" (p. 2-31)
- "Image quality" (p. 2-33)
- "Gamma control" (p. 2-34)
- "Image control" (p. 2-35)
- "Base color level" (p. 2-35)
- "Program" (p. 2-36)
- "Add cover" (p. 2-40)
- "Collate/slip sheet" (p. 2-41)
- "Auto-Rotate" (p. 2-43)
- "Staple/Punch" (p. 2-43)

- "Paper folding" (p. 2-45)
- "Booklet" (p. 2-47)
- "Output tray" (p. 2-49)
- "Paper guide control" (p. 2-50)
- "Jump wing control" (p. 2-51)
- "Head cleaning" (p. 2-51)
- "Front doors release" (p. 2-52)

Direct Access entry

Up to 4 frequently used functions can be registered to the direct access area of the [Basic] screen.

1 Press [Entry].

The [Direct Access entry] screen is displayed.

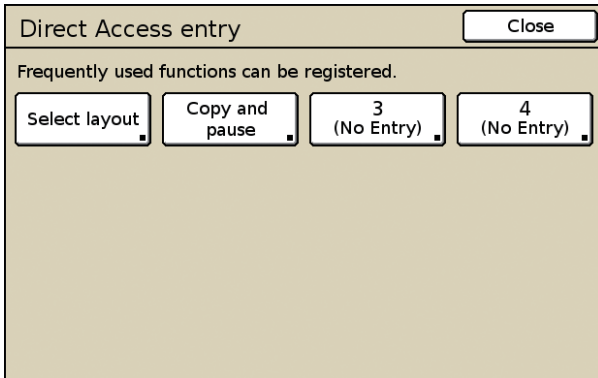

2 Press a button to register (or change) a function.

The [Function list] screen is displayed.

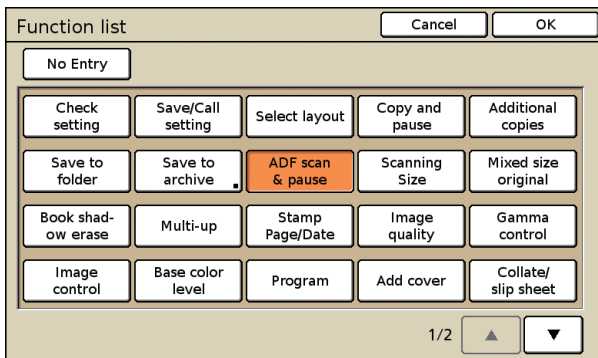

3 Press the button of the function you want to register.

- To cancel registration, press [No Entry].

4 Press [OK].

The settings are confirmed and the [Direct Access entry] screen is displayed.

5 Repeat Steps 2 to 4 to register additional functions as needed.

6 Press [Close].

The previous screen is displayed.

Selections entry

Up to 16 frequently used functions can be registered to the [Selections] screen.

1 Press [Selections].

2 Press [Entry].

The [Selections entry] screen is displayed.

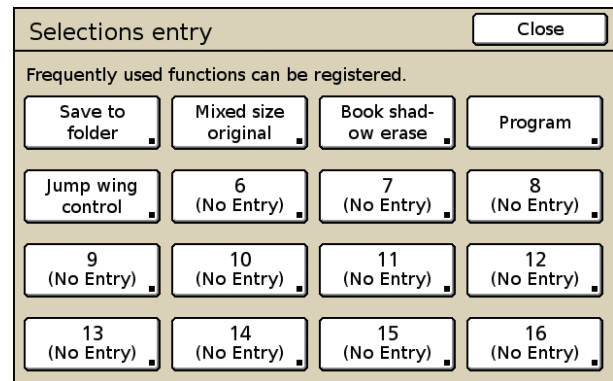

3 Press a button to register (or change) a function.

The [Function list] screen is displayed.

4 Press the button of the function you want to register.

- To cancel registration, press [No Entry].

5 Press [OK].

The settings are confirmed and the [Selections entry] screen is displayed.

6 Repeat Steps 3 to 5 to register additional functions as needed.

7 Press [Close].

The previous screen is displayed.

Copying Functions

This section describes the copy functions that are configured with the [Functions] screen.



You can register frequently used functions to the [Basic] screen or the [Selections] screen. (p. 2-17 "Direct Access entry", p. 2-17 "Selections entry")

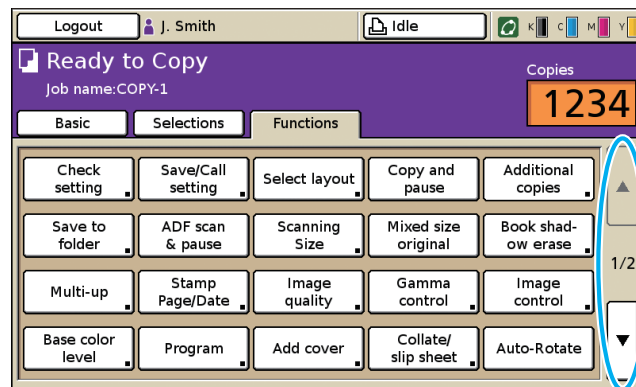

Press [▲] and [▼] scroll the list.

Check setting

Confirm the copy mode settings and print the settings information. You can also register the current settings as the default values and restore the default values set by the administrator.



When login is not necessary, users other than the administrator cannot register or clear the default values.

Confirming the Settings and Printing a List of the Settings

Confirm the settings and print the settings as a list.

1 Press [Functions] on the copy mode screen.

2 Press [Check setting].

The [Check setting] screen is displayed.

Check the current settings.

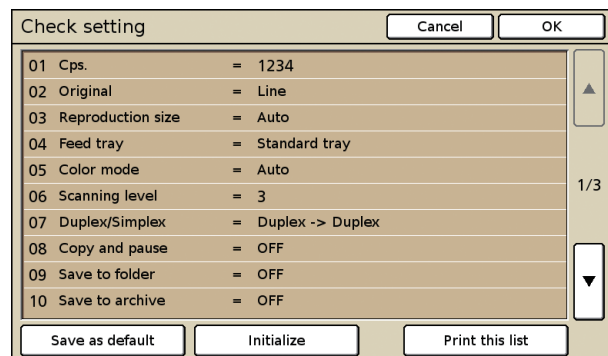

3 Press [Print this list].

The copy mode settings are printed and the [Check setting] screen is displayed.

4 Press [OK].

The previous screen is displayed.

● Registering the Default Values

Register the current settings as the default values.

 When login is not necessary, users other than the administrator cannot register the default values.

1 Press [Check setting].

The [Check setting] screen is displayed.

Check the current settings.

2 Press [Save as default].

The current settings are registered as the default values of copy mode for the user that is currently logged in.

3 Press [OK].

The settings are confirmed and the previous screen is displayed.

● Clearing the Default Values

Return the registered default values to those set by the administrator.

 When login is not necessary, users other than the administrator cannot clear the default values.

1 Press [Check setting].

2 Press [Initialize].

3 Press [OK].

The settings are confirmed and the previous screen is displayed.

Save/Call setting

Frequently used settings information can be registered and retrieved later as needed. You can register up to 10 settings with multiple combined functions.

 You can also display the [Save/Call setting] screen by pressing the [*] key on the operation panel in copy mode.

You can register the following settings in copy mode.

- "Copies" (p. 2-4)
- "Original" (p. 2-12)
- "Reproduction size" (p. 2-9)
- "Feed tray" (p. 2-9)
- "Color mode" (p. 2-8)
- "Scanning level" (p. 2-13)
- "Duplex/Simplex" (p. 2-14)
- "Copy and pause" (p. 2-23)
- "Save to folder" (p. 2-24)
- "Save to archive" (p. 2-26)
- "ADF scan & pause" (p. 2-27)
- "Scanning size" (p. 2-27)
- "Mixed size original" (p. 2-28)
- "Book shadow erase" (p. 2-29)
- "Multi-up" (p. 2-30)
- "Stamp Page/Date" (p. 2-31)
- "Image quality" (p. 2-33)
- "Gamma control" (p. 2-34)
- "Image control" (p. 2-35)
- "Base color level" (p. 2-35)
- "Program" (p. 2-36)
- "Collate/slip sheet" (p. 2-41)
- "Auto-Rotate" (p. 2-43)
- "Add cover" (p. 2-40)
- "Staple/Punch" (p. 2-43)
- "Paper folding" (p. 2-45)
- "Booklet" (p. 2-47)
- "Output tray" (p. 2-49)

● **Saving Settings**

1 Use the copy mode screen to configure the copy functions you want to save or retrieve.

2 Press [Functions] on the copy mode screen.

3 Press [Save/Call setting].
The [Save/Call setting] screen is displayed.

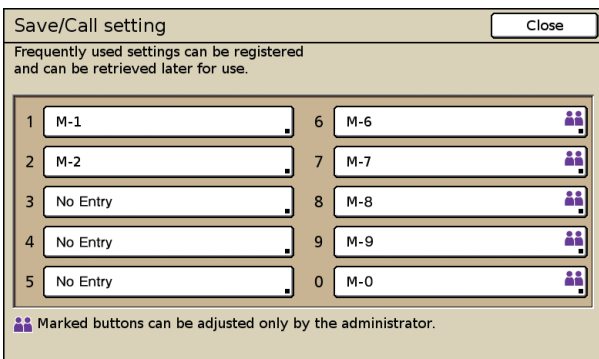

- [No Entry] is displayed for buttons that do not have registered settings.

4 Press [No Entry].
The [Setting entry] screen is displayed.

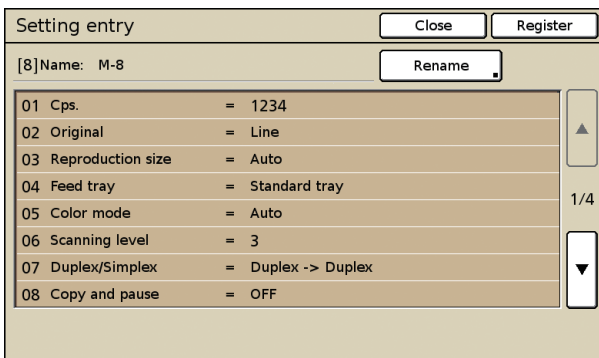

5 Confirm the setting.

The current settings are displayed on the [Setting entry] screen.

To add a name to a button, go to Step 3 in "Renaming the Settings".

 When login is necessary, users with administrative authority can register settings shared by all users. During this step, press [Setting is shared by all users].

6 Press [Register].

The copy mode settings set in Step 1 are registered.

- The registration name is displayed as "M" with a registration number ([M-1] to [M-9] and [M-0]).

7 Press [Close].

The previous screen is displayed.

● **Retrieving Settings**

1 Press [Save/Call setting].

Follow Steps 2 and 3 in "Saving Settings".

2 Press the button of the setting to retrieve.

The [Setting call] screen is displayed.

Confirm the setting.

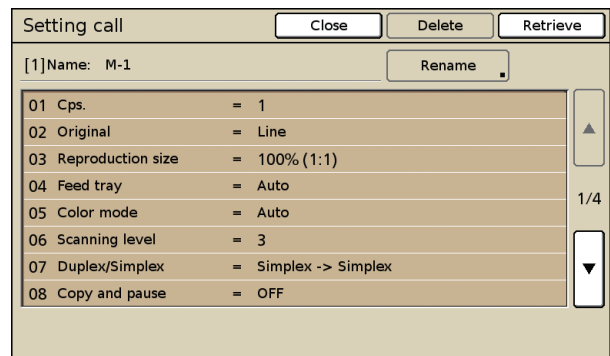

3 Press [Retrieve].

The setting is retrieved and the copy mode screen is displayed.

● Renaming the Settings

Rename the buttons with registered settings.



Users without administrative authority cannot rename shared registered settings (buttons with the shared mark .

1 Display the [Save/Call setting] screen.

Follow Steps 2 and 3 in "Saving Settings".

2 Press a button to rename.

The [Setting call] screen is displayed.

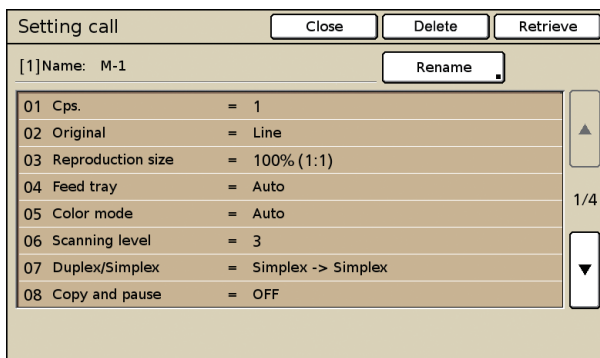

3 Press [Rename].

The [Rename] screen is displayed.

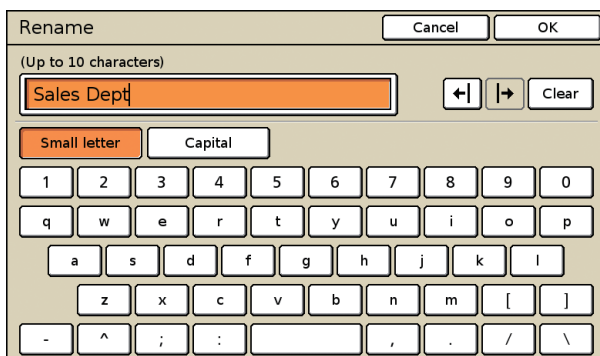

4 Enter a name and press [OK].

- Enter a name up to 10 characters long, and press [OK]. (p. 15 "Entering Text")
- To erase the character to the left side of the cursor for entering a new character, press [Clear].



5 Press [Close].

If you want to register a new setting, press [Register] at this step.

6 Press [Close].

The previous screen is displayed.

● Deleting Settings

 Users without administrative authority cannot delete shared registered settings (buttons with the shared mark )

1 Display the [Save/Call setting] screen.

Follow Steps 2 and 3 in "Saving Settings".

2 Press the button of the setting to delete.

The [Setting call] screen is displayed.

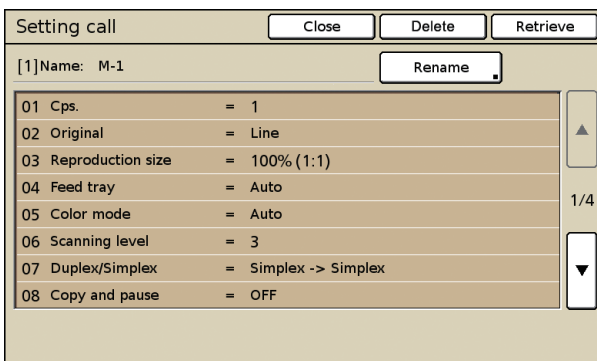

3 Press [Delete].

The message "This setting will be deleted. Are you sure?" appears.

4 Press [Yes].

5 Press [Close].

The previous screen is displayed.

Select layout

Set various finishing settings by selecting an output image.

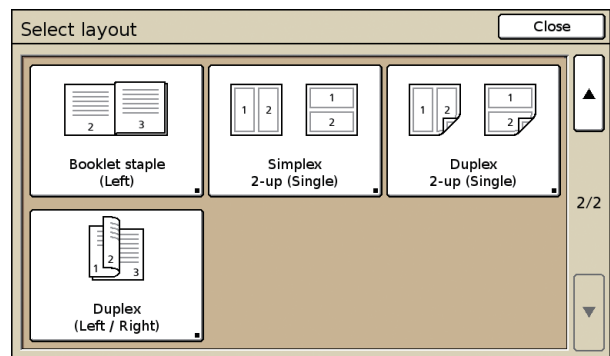
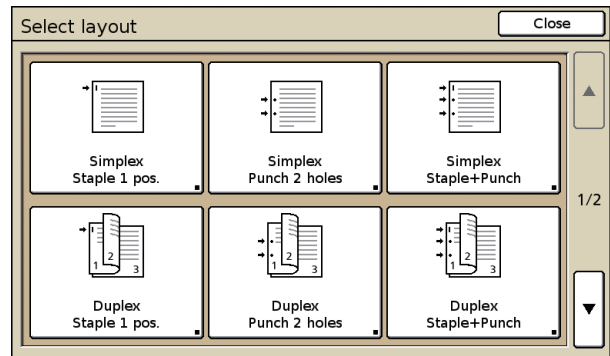

 The actual display may be different than the above screenshot depending on the optional equipment connected.

1 Press [Functions] on the copy mode screen.

2 Press [Select layout].

The [Select layout] screen is displayed.

3 Select the output image.

The [Duplex/Simplex] screen is displayed.

- 4 Select the [Paging Direction] (when selecting [Duplex]) and [Original orientation] settings.

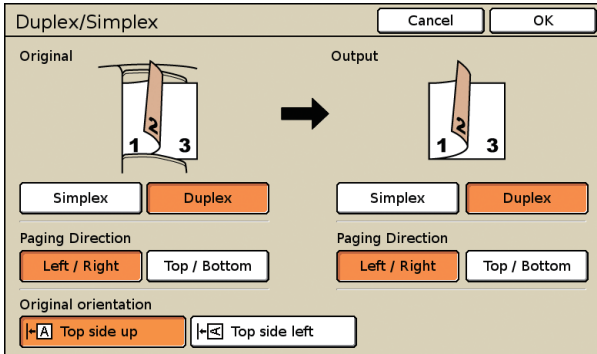

- 5 Press [OK].

The output settings are completed and the copy mode screen is displayed.

Copy and pause

This function is useful for high-volume copying. One sheet is copied and then copying stops, enabling you to check the result of the settings.

- When [Collate] has been set to [Sort], you can use Copy and pause to copy only one set. (p. 2-41 "Collate/slip sheet")

- 1 Press [Functions] on the copy mode screen.

- 2 Press [Copy and pause].

Copy and pause is set.

- Press again to cancel the setting.

After the necessary settings are completed, press the [START] key to begin scanning of the original. One sheet (set) is printed, and then the following screen is displayed.

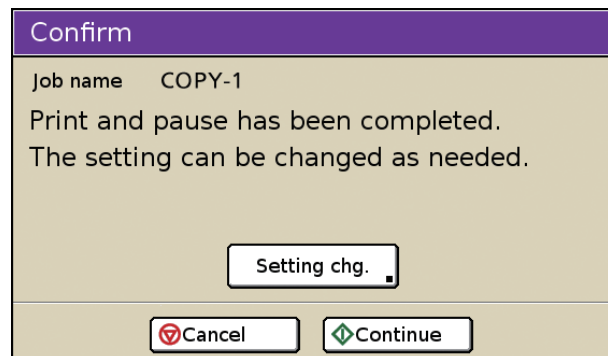

- To continue copying without changing the settings, press [Continue].
- To change the settings, press [Setting chg.], and then change the settings. (p. 4-6 "Changing Settings During Printing" in "Printer")
- To cancel copying, press [Cancel].

Additional copies

Print one or more copies of previously copied original data with the same copy settings. (You do not need to scan the original again.)



Additional copies cannot be made in the following cases:

- When the administrator has set "Additional copies" to [OFF]
- When auto reset has been executed after copying the original
- When the owner is logged out

1

Immediately after completing copying, press [Functions] on the copy mode screen.

2

Press [Additional copies].

The following screen is displayed.

3

Use the numeric keys to specify the number of sets.

4

Press [OK].

Printing of additional copies starts.

Save to folder

Save scanned originals and their settings as data to the machine. You can retrieve the data and print it when needed.



When the administrator has set [Folder function] to [OFF], [Save to folder] is not displayed.



Data saved in folders is retrieved using the [Folder] screen in printer mode. (p. 4-9 "[Folder] Screen" in "Printer")

■ Save to folder

[OFF]

Do not save the data.

[Save]

Save the data in a folder.

[Save & Copy]

Save data in a folder, and then print the data.

■ Directory

The folders configured by the administrator in advance are displayed in the [Directory] list. Data from all users can be saved in shared folders. When login is necessary, the personal folders to which users who are logged in can save data are displayed.

■ Owner

Specify the owner of data to save.

■ Job name

Type or edit the job name of data to save.

■ PIN code

Select whether to assign a PIN code for data to save.

[Not use]

Do not specify a PIN code.

[Use]

Specify a PIN code (up to eight numbers).

1 Press [Functions] on the copy mode screen.

2 Press [Save to folder].

The [Save to folder] screen is displayed.

3 Select the save operation.

Press [Save] or [Save & Copy].

4 Select the storage directory.

5 Change the owner name.

By default, the name of the logged in user is displayed. To change the name, press [Owner] and specify the owner name.

- Enter a name up to 10 characters long on the text input screen. (p. 15 "Entering Text")

6 Change the job name.

To change the name, press [Job name] and type or edit the job name.

- Enter a name up to 10 characters long on the text input screen. (p. 15 "Entering Text")

7 Specify the PIN code.

To add a PIN code when saving the data, press [Use].

Use the numeric keys to enter a PIN code (up to 8 numbers) on the [PIN code] screen, and press [OK].

- The entered PIN code is displayed with asterisks "*".
- To clear the fields, press the [Clear] key.

8 Press [OK].

The settings are confirmed and the previous screen is displayed.

Save to archive

Save scanned originals and the settings as data to an optional external controller (ComColorExpress IS900C). You can retrieve the data and print it when needed.



- This function is displayed when an optional external controller is connected to the machine.
- For information on how to retrieve data saved to the archive, see the guide of the external controller.

■ Save to archive

[OFF]

Do not save the data.

[Save]

Save the data.

■ Owner

Specify the owner of data to save.

■ Job name

Type or edit the job name of data to save.

1 Press [Functions] on the copy mode screen.

2 Press [Save to archive].

The [Save to archive] screen is displayed.

Save to archive

Cancel OK

OFF

Save

Owner: J.Smith

Job name: COPY-1

3 Press [Save].

4 Change the owner name.

By default, the name of the logged in user is displayed. To change the name, press [Owner] and specify the owner name.

- Enter a name up to 10 characters long on the text input screen. (p. 15 "Entering Text")

5 Change the job name.

To change the name, press [Job name] and type or edit the job name.

- Enter a name up to 10 characters long on the text input screen. (p. 15 "Entering Text")

6 Press [OK].

The settings are confirmed and the previous screen is displayed.

ADF scan & pause

When copying a quantity of originals that cannot be loaded at one time in the ADF, these can be copied as one job. Up to 1,000 one-sided originals or 500 two-sided originals can be copied as one job.

- The maximum number of sheets that can be loaded at one time in the ADF is 100 sheets (with a paperweight of 80 g/m² (21.3-lb bond)).
- Scan all originals using the ADF, and do not use the platen glass.

1 Press [Functions] on the copy mode screen.

2 Press [ADF scan & pause].

ADF scan & pause is set.

- Press again to cancel the setting.

The following screen is displayed after copying starts and all loaded originals have been scanned.

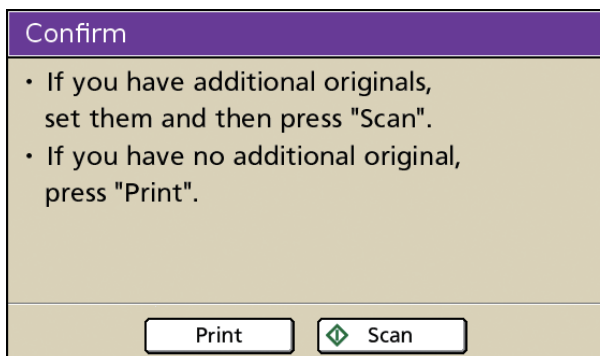

- When there are additional originals, load the originals in the ADF and press [Scan].
- When there are no additional originals, press [Print] to start copying of the scanned originals.

Scanning size

Specify the scanning size for originals.

● Selecting standard size or registered size

Select a standard paper size or registered paper size by the administrator.

[Auto]

Standard size originals are detected automatically. If the original is a standard size, normally select [Auto].

Original size list

When selecting a paper size that is different from the original even though the original is a registered size or standard size, select from the original size list.

When the administrator has registered paper sizes in advance with "Custom paper entry", registered paper sizes are displayed.

1 Press [Functions] on the copy mode screen.

2 Press [Scanning size].

The [Scanning size] screen is displayed.

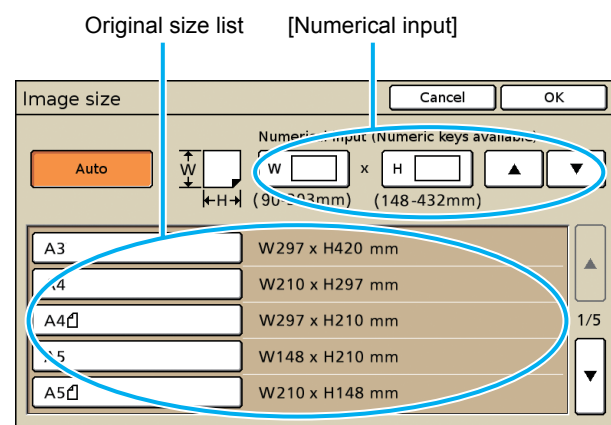

3 Select the original size from the original size list.

4 Press [OK].

The settings are confirmed and the previous screen is displayed.



The following paper sizes are not displayed among the registered paper sizes on the original size list.

- Width (W):90mm - 303mm (3 9/16" -13")
- Height (H):148mm - 432mm (11 15/16" - 17")

● Entering the Size of the Original

When the original is a non-standard size that is not registered, specify the size of the original to be scanned.

1 Display the [Scanning size] screen.

Follow Steps 1 and 2 in "Specifying standard paper or registered paper".

2 Enter the original size.

Press the input box of [Numerical input], and enter the numbers using [▲] and [▼] or the numeric keys.

Specify the size in a range of 90 to 303 mm (W) by 148 to 432 mm (H) (3 9/16" to 11 15/16" (W) by 5 13/16" to 17" (H)).

- To clear the fields, press the [Clear] key.

3 Press [OK].

The settings are confirmed and the previous screen is displayed.

Mixed size original

Specify this option when loading originals with multiple sizes.



- Only originals with one side of equivalent length (A4 and A3, B4 and B5, Ledger and Letter) can be scanned together.
- You cannot use "Mixed size original" and "Booklet", "Book shadow erase", or "Multi-up" at the same time. (p. 2-47 "Booklet", p. 2-29 "Book shadow erase", p. 2-30 "Multi-up")

1 Load the originals so that the sides of equivalent length are aligned.

2 Select [Auto] for [Feed tray].

For information on how to configure the feed tray settings, see "Feed tray" (p. 2-9).

3 Press [Functions] on the copy mode screen.

4 Press [Mixed size original].

"Mixed size original" is set.

- Press again to cancel the setting.

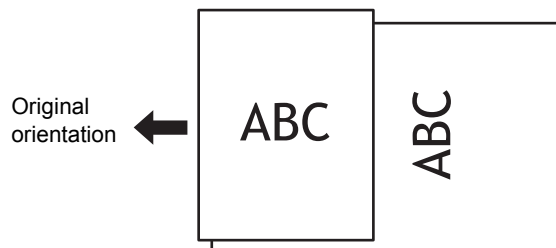

Book shadow erase

Erase shadows that appear in the center of copies when copying an open book.

 When placing a book on the platen glass, place it top side up and aligned with the arrow at the upper left of the glass surface. This function cannot be used with the book placed vertically or at an angle.

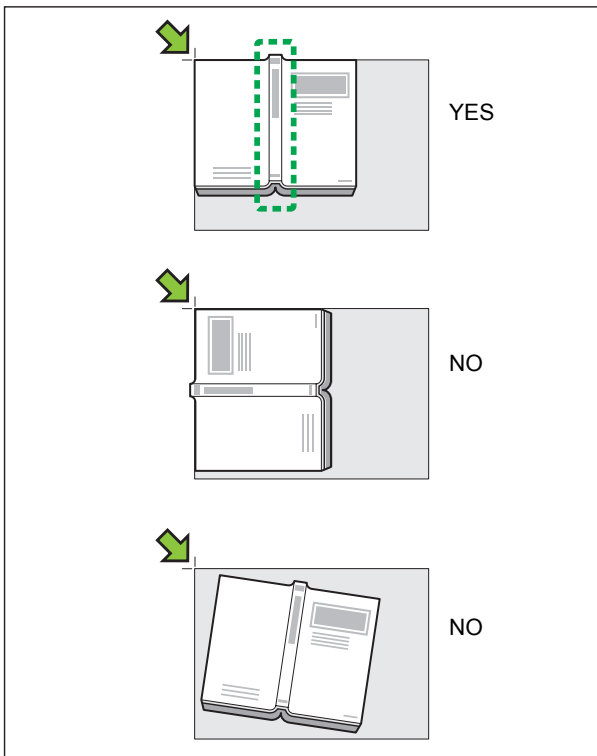

■ Center erase

[ON], [OFF]

■ Erasure width

[10mm](3/8"), [20mm](13/16"), [30mm](1 3/16"), [40mm](1 9/16"), [50mm](1 15/16")

1 Press [Functions] on the copy mode screen.

2 Press [Book shadow erase].

The [Book shadow erase] screen is displayed.

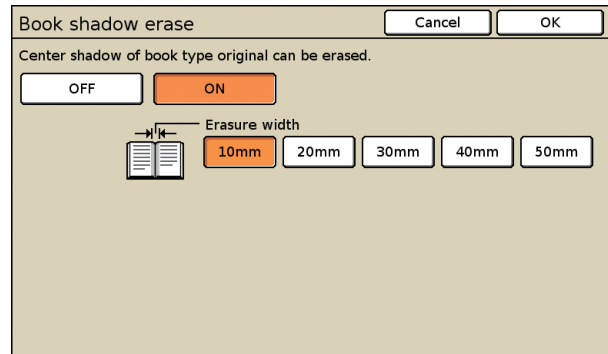

3 Press [ON].

4 Select the erasure width.

5 Press [OK].

The settings are confirmed and the previous screen is displayed.

Multi-up

Impose several pages of an original onto one sheet.

You can select [Plural] or [Single]



You cannot use "Multi-up" and "Mixed size original" at the same time. (p. 2-28 "Mixed size original")

● Setting Multi-up (Plural)

Impose continuous pages onto one sheet.

■ Original orientation

[Top side up]

Select this when loading originals in an orientation from which they can be read normally.

[Top side left]

Select this when loading originals so that the top of the original is aligned with the left edge.

■ Pages/sheet

Select the number of pages per sheet.

[2], [4], [8]

■ Layout order

When you have selected [2]

[Left to right (T to B)], [Right to left (B to T)]

When you have selected [4] or [8]

[Left top to right], [Left top to bottom], [Right top to left], [Right top to bottom]

- 1 Press [Functions] on the copy mode screen.

- 2 Press [Multi-up].

The [Multi-up] screen is displayed.

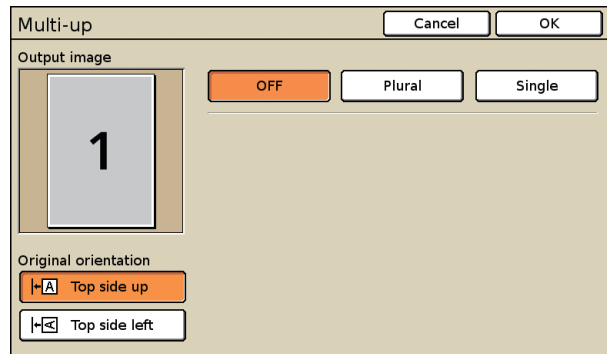

[Output image] displays an output image that reflects the settings.

- 3 Select the original orientation.

- 4 Press [Plural].

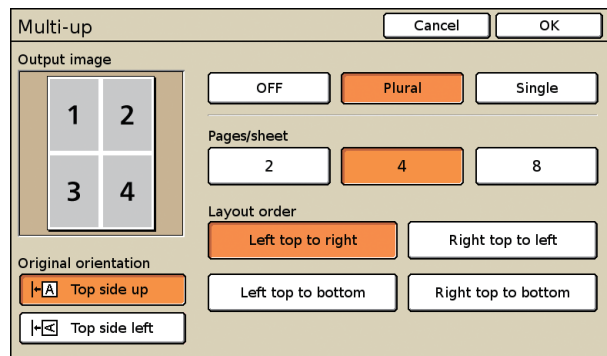

[Output image] displays an output image that reflects the settings.

- 5 Select the number of pages per sheet.

- 6 Select the layout order.

- 7 Press [OK].

The settings are confirmed and the previous screen is displayed.

● Setting Multi-up (Single)

This imposes multiple copies of the same original onto one sheet.

■ Original orientation

[Top side up]

Select this option when loading originals in an orientation from which they can be read normally.

[Top side left]

Select this option when loading originals so that the top of the original is aligned with the left edge.

■ Pages/sheet

Select the number of pages per sheet.

[2], [4], [8]

1 Display the [Multi-up] screen.

Follow Steps 1 and 2 in "Setting Multi-up".

2 Select the original orientation.

3 Press [Single].

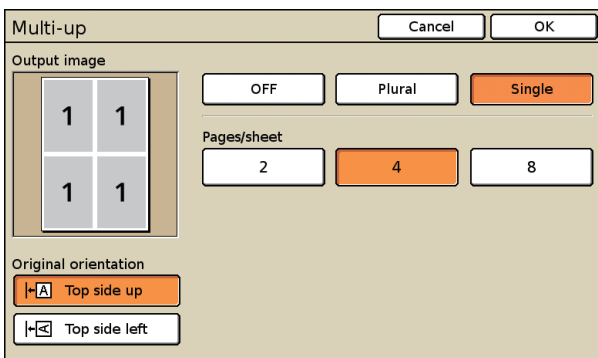

[Output image] displays an output image that reflects the settings.

4 Select the number of pages per sheet.

5 Press [OK].

The settings are confirmed and the previous screen is displayed.

Stamp Page/Date

Stamp the page number and date on the header or footer.

- The page number and date cannot be stamped together in the same position.
- The page number and date cannot be stamped on slip sheet paper or cover paper. (p. 2-40 "Add cover", p. 2-41 "Collate/slip sheet")
- When using this with "Multi-up", the page number and date are stamped on each page of the copy paper, not on the original page. However, when using "Booklet", the page number and date are stamped on each page after the booklet is created.
- Specifying the reproduction ratio does not affect the stamped size of the page number and date.

2

● Stamping the Page Number

Stamp the page number on the header or footer.

■ Stamp position

[Top L], [Top C], [Top R], [Bottom L], [Bottom C], [Bottom R]

■ Transparency

[OFF]

Remove images in the stamp area to create a white space, and stamp the page number in that white space.

[ON]

Stamp page number on top when the stamp area and images overlap.

■ Start number

Specify the initial number to stamp (1 to 9).

■ Stamp start page

Specify the initial page to stamp (1 to 9).

Example: When the stamp start page has been set to [2] and the stamp start number has been set to [3]

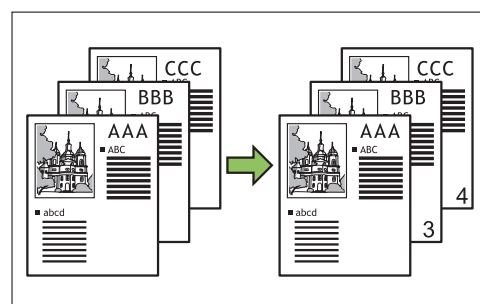

1 Press [Functions] on the copy mode screen.

2 Press [Stamp Page/Date].

The [Page] screen is displayed.

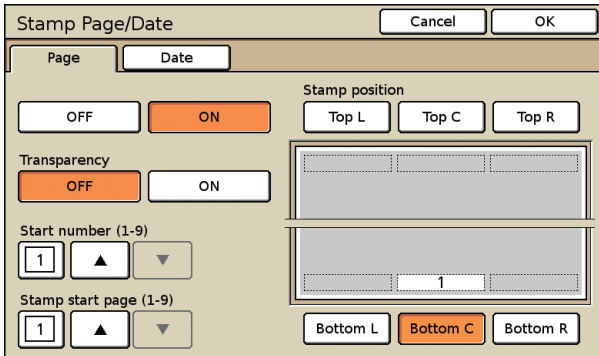

3 Press [ON].

4 Select the stamp position.

5 Select the transparency.

6 Specify the start number.

Use [▲] and [▼] to enter a number between 1 and 9. You cannot enter "0".

- You can also enter the number using the numeric keys.
- To clear the fields, press the [Clear] key.

7 Specify the stamp start page.

Use [▲] and [▼] to enter a number between 1 and 9. You cannot enter "0".

- You can also enter the number using the numeric keys.
- To clear the fields, press the [Clear] key.

To not stamp on the cover, set "Stamp start page" to "2" (For duplex printing, set this to "3" depending on the case).

8 Press [OK].

The settings are confirmed and the previous screen is displayed.

Stamping the Date

Print the date on the header or footer.

Stamp position

[Top L], [Top C], [Top R], [Bottom L], [Bottom C], [Bottom R]

Transparency

[OFF]

Remove images in the stamp area to create a white space, and stamp the date in that white space.

[ON]

Stamp date on top when the stamp area and images overlap.

Applied page

Select the page(s) to stamp the date.

[All pages], [First page]

Stamped date

[Today's date]

Today's date (the date set on the machine) is stamped.

[Specified date]

Specify the date to be stamped.

1 Display the [Stamp Page/Date] screen.

Follow Steps 1 and 2 in "Stamping the Page Number" (p. 2-31).

2 Press [Date].

The [Date] screen is displayed.

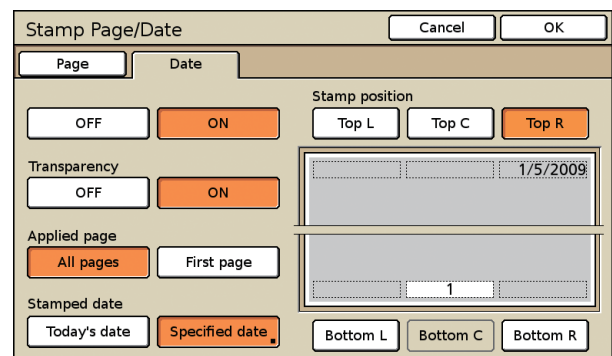

3 Press [ON].

4 Select the date stamp position.

- You cannot select the position for stamping the page number.

5 Select the transparency.

6 Select the pages to apply.

7 Select the date to be stamped.

Select [Specified date] to display the [Specified date] screen.

Press the input box and enter the date using [▲] and [▼] or the numeric keys.

- To clear the fields, press the [Clear] key.

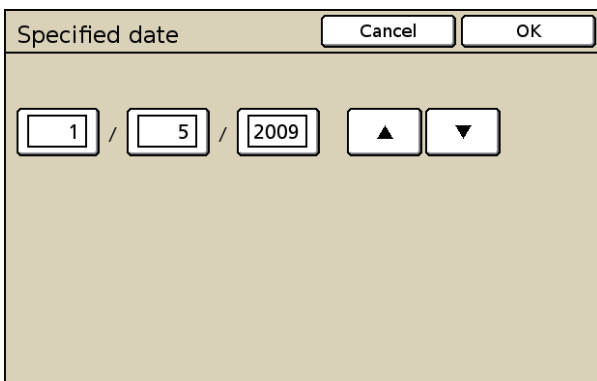

- Press [OK] on the [Specified date] screen to confirm the setting and display the [Date] screen.

8 Press [OK].

The settings are confirmed and the previous screen is displayed.

Image quality

Specify the resolution for scanning originals.

[Standard (300 × 300dpi)]

Select this when the original has mostly text.

[Fine (300 × 600dpi)]

Select this when the original has photos. Scan with higher resolution.

1 Press [Functions] on the copy mode screen.

2 Press [Image quality].

The [Image quality] screen is displayed.

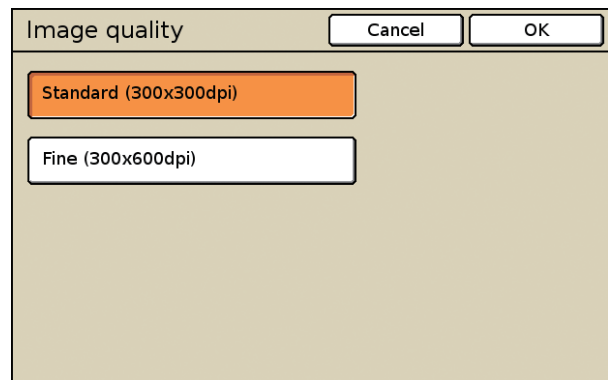

3 Select the resolution.

4 Press [OK].

The settings are confirmed and the previous screen is displayed.

Gamma control

Adjust the color balance (CMYK) of scanned images.

C [1] to R [7]

The lower the setting (toward [1]), the stronger the cyan (C) and the weaker the red (R) in the image. The higher the setting (toward [7]), the stronger the red (R) and the weaker the cyan (C) in the image.

M [1] to G [7]

The lower the setting (toward [1]), the stronger the magenta (M) and the weaker the green (G) in the image. The higher the setting (toward [7]), the stronger the green (G) and the weaker the magenta (M) in the image.

Y [1] to B [7]

The lower the setting (toward [1]), the stronger the yellow (Y) and the weaker the blue (B) in the image. The higher the setting (toward [7]), the stronger the blue (B) and the weaker the yellow (Y) in the image.

K [1] to [7]

The higher the setting (toward [7]), the stronger the black (K) in the image, and the lower the setting (toward [1]), the weaker the black (K) in the image.



When [Color mode] has been set to [Black], [Cyan], or [Magenta], the gamma value can only be adjusted for [K]. The gamma value cannot be adjusted between C and R, M and G, or Y and B. (p. 2-8 "Color mode")

1 Press [Functions] on the copy mode screen.

2 Press [Gamma control].

The [Gamma control] screen is displayed.

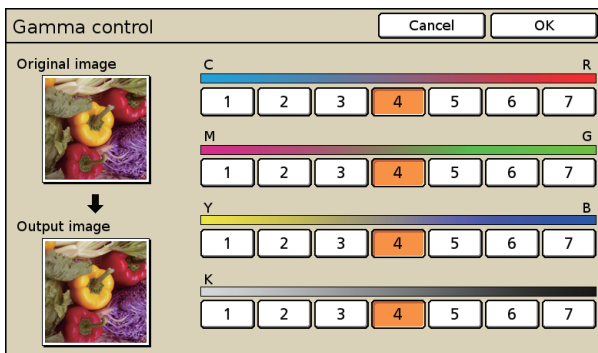

3 Select the balance for each color.

[Output image] displays a preview of the image with the adjusted color balance.

4 Press [OK].

The settings are confirmed and the previous screen is displayed.

Image control

Specify the appropriate image processing settings for scanned originals.

[Auto]

The values are automatically configured based on the "Color mode" and "Original" settings. (p. 2-8 "Color mode", p. 2-12 "Original")

Photo/Line level [1] to [7]

The higher the setting (toward [7]), the higher the text recognition (even text with unclear outlines is recognized as text).

Edge enhancement [1] to [7]

The higher the setting (toward [7]), the greater the emphasis on the edge of portions recognized as text.

Moire elimination [1] to [7]

The higher the setting (toward [7]), the greater the reduction of moire in portions recognized as photos.

1 Press [Functions] on the copy mode screen.

2 Press [Image control].

The [Image control] screen is displayed.

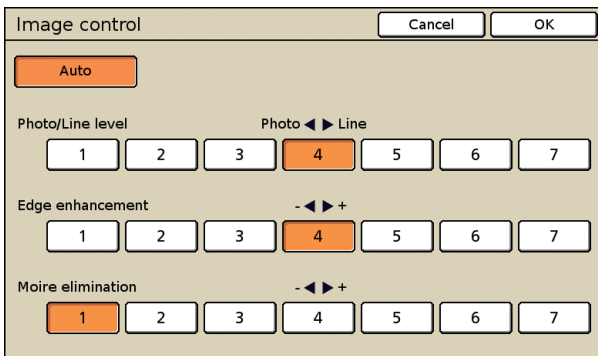

3 Select the image control.

4 Press [OK].

The settings are confirmed and the previous screen is displayed.

Base color level

Make the background color (base color) lighter so that the text is easier to read when copying text originals with a background color or colored paper.

[Auto]

The density of the background color is set automatically.

Base color level density [1] to [7]

The higher the value, the more the background color level is reduced.

1 Press [Functions] on the copy mode screen.

2 Press [Base color level].

The [Base color level] screen is displayed.

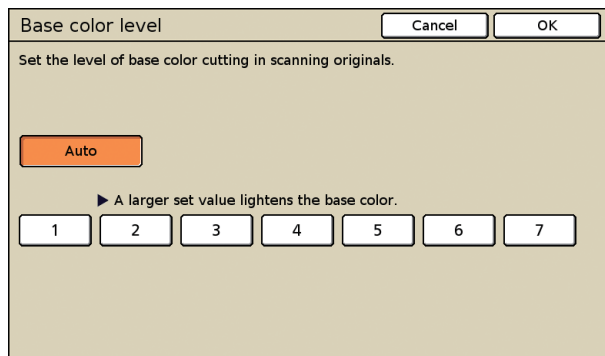

3 Select the base color level.

4 Press [OK].

The settings are confirmed and the previous screen is displayed.

Program

This option is convenient when the number of required copies varies by group (such as corporate division or classes).

You can program settings for the number of copies and sets, collating, slip sheets, and other options for each group. This enables you to quickly print exactly the number of copies of the number of sets you need.



You can configure up to 60 groups.

Examples of Entering the Number of Copies and Sets

- Specify the number of copies between 1 and 9,999 and the number of sets between 1 and 99.

For example, to distribute a document to the parents of all students in first grade in a school, you can use [Program] to print by the number of sheets per class with a single copy operation.

	Class 1	Class 2	Class 3	Class 4	Class 5	Class 6
Students	35	33	35	30	32	33

To output by group, configure the settings as follows.

	Class 1	Class 2	Class 3	Class 4	Class 5	Class 6
Copies × Sets	35 × 1	33 × 1	35 × 1	30 × 1	32 × 1	33 × 1

Even if two classes have the same number of students (such as Classes 1 and 3 or Classes 2 and 6), you can configure the settings as follows to output by the number of sheets per class.

	Classes 1 and 3	Classes 2 and 6	Class 4	Class 5
Copies × Sets	35 × 2	33 × 2	30 × 1	32 × 1

Collate

Specify the type of collation ([Group] or [Sort]) for program printing.

[Auto]

Copies are collated in sets when loaded on the ADF and by page when loaded on the platen glass.

[Group]

Copy by page.

[Sort]

Copy in sets.

Slip sheet

Specify how slip sheets are inserted.

[OFF]

Do not insert a slip sheet.

[Between sets]

Insert a slip sheet between sets.

[Between groups]

Insert a slip sheet between groups.

[Select tray]

When you select [Between sets] or [Between jobs], specify the feed tray set in [Slip sheet].

Number on slip sheet

[ON]

Stamp the group number and set number when set to [Between sets], and stamp the group number when set to [Between groups].

[OFF]

Do not stamp numbers.



- [Number on slip sheet] is only available when outputting two or more copies.
- You cannot use this function with [Collate/slip sheet] on the [Functions] screen.

Offset output

Stack each print job shifted apart from one another.

[OFF]

Do not shift each print job apart from one another.

[Between sets]

Stack each print set shifted apart from one another.

[Between groups]

Stack each print group shifted apart from one another.



- A multifunction finisher or face down offset tray is required to use this setting.

● Configuring the Program

Configure new settings (copies, sets, etc.) for each group (01G to 60G).

1 Press [Functions] on the copy mode screen.

2 Press [Program].

The [Program (1)] screen is displayed.

3 Enter the number of copies and sets.

Press the input box and enter the number using the numeric keys.

After you enter the number of copies and sets, the total number of copies is displayed.

- To clear the fields, press the [Clear] key.
- Press the [*] key to enter a number in the next input box.
- Press [▲] and [▼] to scroll the list.

To use the settings without saving them, go to Step 4. To save the settings, go to Step 3 in "Saving a Program".

4 Press [Next].

The [Program (2)] screen is displayed.

5 Configure the [Collate], [Slip sheet], and [Offset output] settings.

- [Number on slip sheet] is only available when outputting two or more copies.
- You cannot use this function with "Collate/slip sheet" on the [Functions] screen.

6 Press [OK].

The settings are confirmed and the copy mode screen is displayed.

2

● Saving a Program

Save settings to retrieve and use later. Up to 12 program settings can be saved and recalled later as needed.

1 Display the [Program (1)] screen.

Follow Steps 1 and 2 in "Configuring the Program".

2 Enter the number of copies and sets.

Press the input box and enter the number using the numeric keys.

- To clear the fields, press the [Clear] key.
- Press the [*] key to enter a number in the next input box.
- Press [▲] and [▼] to scroll the list.

3 Press [Save/Call].

The [Program list] screen is displayed.

- When 12 program settings have already been saved, delete one before saving a new program. ("Deleting a Program" (p. 2-40))

4 Press [Register] on the [Program list] screen.

The [Registration name] screen is displayed.

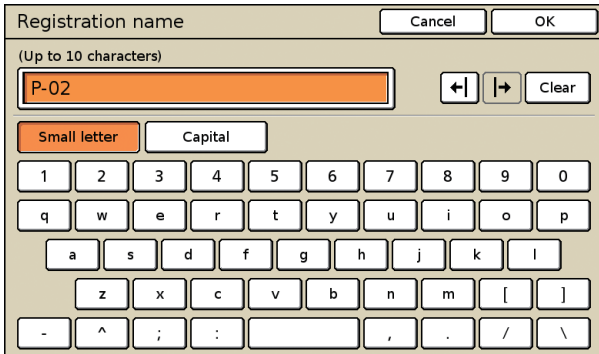

5 Enter the registration name of the program.

- Enter a name up to 10 characters long. (p. 15 "Entering Text")

6 Press [OK].

The program is saved and the [Program list] screen is displayed.

- To only save the program, press [Close], and then press [Cancel] on the [Program (1)] screen.
- To copy, press [Close] and then press [Next] on the [Program (1)] screen.

Retrieving a Program

Retrieve a saved program.

1 Display the [Program (1)] screen.

Follow Steps 1 and 2 in "Configuring the Program".

2 Press [Save/Call].

The [Program list] screen is displayed.

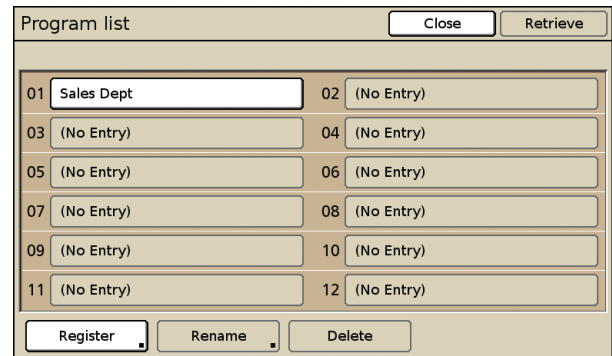

3 Select the program to retrieve.

- Select one program.

4 Press [Retrieve].

The [Program (1)] screen for the selected settings is displayed.

5 Press [Next].

The [Program (2)] screen is displayed.

6 Configure the [Collate], [Slip sheet], and [Offset output] settings.

! You cannot use this function with "Collate/slip sheet" on the [Functions] screen.

7 Press [OK].

The settings are confirmed and the copy mode screen is displayed.

- To return to the [Program (1)] screen, press [Back].

● Renaming a Program

1 Display the [Program (1)] screen.

Follow Steps 1 and 2 in "Configuring the Program".

2 Press [Save/Call].

The [Program list] screen is displayed.

3 Select the program to rename.

- Select one program.

4 Press [Rename].

The [Rename] screen is displayed.

The current registration name is displayed in the input box.

5 Enter the new registration name.

- Enter a name up to 10 characters long on the text input screen. (p. 15 "Entering Text")

6 Press [OK].

The new registration name is saved and the [Program list] screen is displayed.

- To only rename the program, press [Close], and then press [Cancel] on the [Program (1)] screen.
- To copy, press [Close] and then press [Next] on the [Program (1)] screen.

● Changing the program settings

Change the number of copies and sets for the program.

1 Display the [Program (1)] screen.

Follow Steps 1 and 2 in "Configuring the Program".

2 Press [Save/Call].

The [Program list] screen is displayed.

3 Select the program with the settings to change.

4 Press [Retrieve].

The [Program (1)] screen is displayed.

5 Enter the number of copies and sets.

- See "Configuring the Program" (p. 2-37) for details on how to enter the number of copies and sets.

6 Press [Overwrite].

The changes are saved.

- To only change the program, press [Cancel].
- To copy, press [Close] and then press [Next] on the [Program (1)] screen.

● Deleting a Program

- 1 **Display the [Program (1)] screen.**
Follow Steps 1 and 2 in "Configuring the Program".
- 2 **Press [Save/Call].**
The [Program list] screen is displayed.
- 3 **Select the program to delete.**
 - You can also select multiple programs.
- 4 **Press [Delete].**
The message "Selected setting will be deleted. Are you sure?" appears.
- 5 **Press [Yes].**
The program is deleted and the [Program list] screen is displayed.
- 6 **Press [Close].**
The [Program (1)] screen is displayed.
- 7 **Press [Cancel].**

Add cover

Add preprinted sheets or colored paper that has been loaded in the tray, to the front and back of the printouts as covers.

■ Binding side

Select the binding side of the paper.
[Left], [Right], [Upper]

■ Front cover

[No]
[Yes]
A cover is added to the front of the printouts.
Select the feed tray to use.

■ Back cover

[No]
[Yes]
A cover is added to the back of the printouts.
Select the feed tray to use.

! You cannot use paper of a different size from that of the paper to be copied.

1 **Press [Functions] on the copy mode screen.**

2 **Press [Add cover].**

The [Add cover] screen is displayed.

The screenshot shows the 'Add cover' dialog box with the following elements:

- Title Bar:** 'Add cover' with 'Cancel' and 'OK' buttons.
- Message:** 'When copying, a printed cover can be added.'
- Binding side:** Three buttons labeled 'Left', 'Right', and 'Upper'. The 'Left' button is highlighted with an orange background.
- Front cover:** 'No' and 'Yes' buttons. The 'Yes' button is highlighted with an orange background. To the right is a 'Setting orient' dropdown menu showing a portrait icon.
- Select tray:** A dropdown menu showing '1 A3 297x420mm Plain Standard'.
- Back cover:** 'No' and 'Yes' buttons. The 'Yes' button is highlighted with an orange background. To the right is a 'Setting orient' dropdown menu showing a portrait icon.
- Select tray:** A dropdown menu showing '1 A3 297x420mm Plain Standard'.

3 **Select the binding side.**

4 Configure the cover settings.

Select [Yes] or [No] for [Front cover] and [Back cover].

5 Press the select tray button.

Press [Yes] to display the [Select tray] screen.

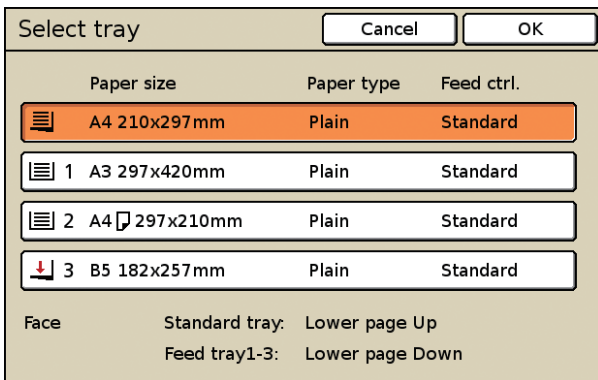

Select the feed tray that is loaded with cover paper, and press [OK].
 The cover paper settings are confirmed and the [Add cover] screen is displayed.

6 Press [OK].

The settings are confirmed and the previous screen is displayed.

7 Load the cover paper.

Load cover paper in the tray selected in Step 5.

- The side in which the paper is loaded varies depending on the tray.
 Standard tray: Load the paper with the first page facing up.
 Feed tray: Load the paper with the first page facing down.
 See "Loading Paper" (p. 23) in "Print Preparations".
- Change the paper type and feed control settings to match the paper to be loaded. (p. 2-9 "Feed tray")

Collate/slip sheet

Specify the paper output method when copying multiple copies. You can configure the [Slip sheet] and [Offset output] settings.

Configuring the Collate Setting

Specify the collate method when copying multiple copies.

[Auto]

Copies are collated in sets when the original is loaded on the ADF and by page when the original is loaded on the platen glass.

[Group]

Collate by page.

[Sort]

Collate in sets.

1 Press [Functions] on the copy mode screen.

2 Press [Collate/slip sheet].

The [Collate/slip sheet] screen is displayed.

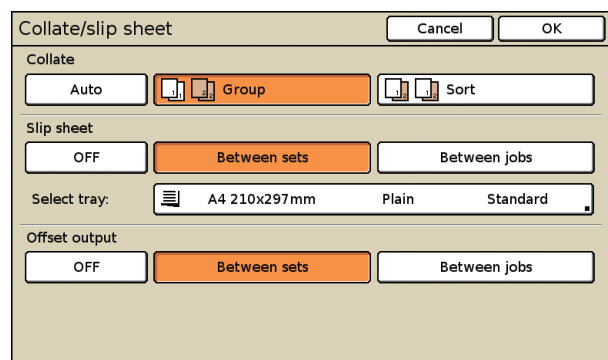

3 Select the collate method.

To configure [Slip sheet] or [Offset output], go to Step 2 (p. 2-42) in the procedure for configuring that setting.

4 Press [OK].

The settings are confirmed and the copy mode screen is displayed.

● Configuring the Slip Sheet Setting

Insert a slip sheet between sets or jobs.

■ Slip sheet

[OFF]

[Between sets]

Insert a slip sheet between sets, based on the unit specified in [Collate].

[Between jobs]

Insert a slip sheet between print jobs.

■ Select tray

When selecting [Between sets] or [Between jobs], select the tray in which [Slip sheet] is loaded.

[Standard tray], [Feed tray1], [Feed tray2], [Feed tray3]



It is recommended that you set [Tray selection] to [Manual] on the [Feed tray] screen, when using special paper as slip sheets.

1 Display the [Collate/slip sheet] screen.

Follow Steps 1 and 2 in "Configuring the Collate Setting".

2 Select the position where slip sheets are to be inserted.

3 Select the feed tray for slip sheets.

Pressing the "Select tray" button will display the [Select tray] screen.

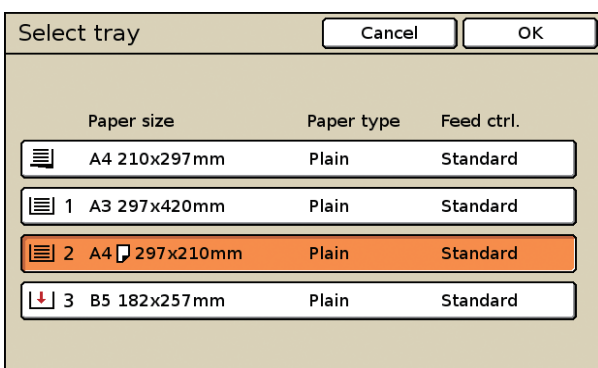

Select the feed tray that is loaded with slip sheets, and press [OK].

The slip sheet settings are confirmed and the [Collate/slip sheet] screen is displayed.

4 Press [OK].

The settings are confirmed and the copy mode screen is displayed.

● Configuring the Offset Output Setting

This function outputs each printout shifted apart from one another.



An optional multifunction finisher or face down offset tray is required to use this setting.

[OFF]

[Between sets]

Stack each collated set shifted apart from one another.

[Between jobs]

Stack each print job shifted apart from one another.

■ Paper that can be offset

- When using the face down offset tray:
131 mm × 148 mm to 305 mm × 550 mm (5 3/16" × 5 13/16" to 12" × 21 5/8")
- When using a multifunction finisher:
A3, B4, A4, A4-R, B5-R, Ledger, Legal, Letter, Letter-R, Foolscap, custom size (203 mm × 182 mm to 297 mm × 488 mm (8" × 7 3/16" to 11 11/16" × 19 3/16"))

1 Display the [Collate/slip sheet] screen.

Follow Steps 1 and 2 in "Configuring the Collate Setting".

2 Select the offset output setting.

3 Press [OK].

The settings are confirmed and the copy mode screen is displayed.

Auto-Rotate

This rotates the image 90 degrees automatically when the orientations of the original and paper do not match, even if the paper size loaded in the tray matches the size of the loaded original. Normally, select [ON].

Staple/Punch

Configure the staple and punch settings.

- An optional multifunction finisher is required to use this setting.
- You cannot use "Staple/Punch" and "Booklet" at the same time. (p. 2-47 "Booklet")

● Configuring the Staple Setting

Staple at the specified position.

<Types of paper that can be stapled>

- Paper size: A3, B4, A4, A4-R, B5-R, Ledger, Legal, Letter, Letter-R, Foolscap and custom size*
 - * The administrator must register the paper size in advance. Ask your administrator.

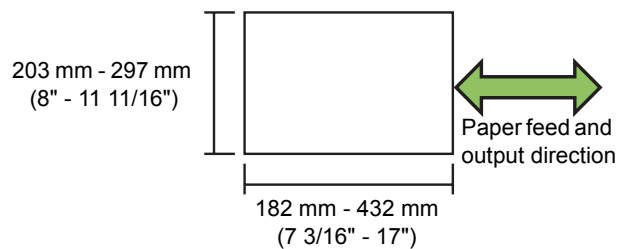

- Paper weight: 52 g/m² (16-lb bond) to 162 g/m² (43-lb bond)
When the paper weight exceeds 162 g/m² (43-lb bond), only one sheet can be stapled for the cover.

<Number of sheets that can be stapled>

- When using standard size paper
 - A4 or A4-R: 2 to 100 sheets*
 - Other standard size paper: 2 to 65 sheets*
- When using non-standard size paper
 - Paper width of 215 mm (8 7/16") or less: 2 to 100 sheets*
 - Paper width of 216 mm (8 1/2") or greater: 2 to 65 sheets*

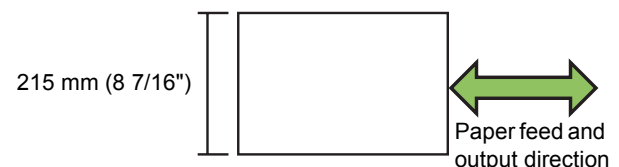

- * When using plain paper and recycled paper (85 g/m² (23-lb bond))

- When printing jobs that exceed the maximum number of sheets that can be stapled, the sheets are outputted to the stacking tray without being stapled.

■ Original orientation

[Top side up]

Select this when loading originals in an orientation from which they can be read normally.

[Top side left]

Select this when loading originals so that the top of the original is aligned with the left edge.

■ Binding side

Select the binding side of the paper.

[Left], [Right], [Upper]

■ Staple

Select the position for stapling.

[OFF], [1 pos.] (or [Left 1], [Right 1]), [2 pos.]



[Left 1] and [Right 1] are displayed only when [Binding side] is set to [Upper].

1 Press [Functions] on the copy mode screen.

2 Press [Staple/Punch].

The [Staple/Punch] screen is displayed.

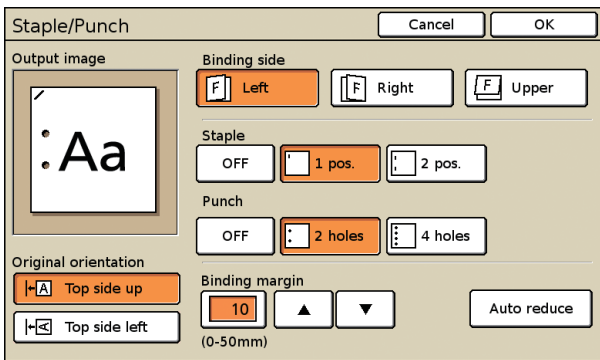

[Output image] displays an output image that reflects the [Staple/Punch] settings.

3 Select the original orientation.

4 Select the binding side.

5 Configure the staple setting.

6 Press [OK].

The settings are confirmed and the previous screen is displayed.

● Configuring the Punch Setting

Punch holes in the paper.



The number of holes that can be punched varies depending on the connected multifunction finisher.

<Types of paper that can be punched>

- Paper size
2 holes: A3, B4, A4, A4-R, B5-R, Ledger, Legal, Letter, Letter-R
3 holes: A3, B4, A4-R, B5-R, Ledger, Letter-R
4 holes: A3, A4-R, Ledger, Letter-R
- Paper weight: 52 g/m² (14-lb bond) to 200 g/m² (53-lb bond)

■ Original orientation

[Top side up]

Select this option when loading originals in an orientation from which they can be read normally.

[Top side left]

Select this option when loading originals so that the top of the original is aligned with the left edge.

■ Binding side

Select the binding side of the paper.

[Left], [Right], [Upper]

■ Punch

Specify the number of holes to be punched.

[OFF], [2 holes], [3 holes], [4 holes]

1 Display the [Staple/Punch] screen.

Follow Steps 1 and 2 in "Configuring the Staple Setting".

2 Select the original orientation.

3 Select the binding side.

4 Configure the punch setting.

5 Press [OK].

The settings are confirmed and the previous screen is displayed.

● Specifying the binding margin

You can specify the binding margin so that staples and punch holes are not in the printing area. Specify the binding margin between 0 mm and 50 mm (1 15/16") (in 1 mm units).

1 Display the [Staple/Punch] screen.

Follow Steps 1 and 2 in "Configuring the Staple Setting".

2 Specify the binding margin.

- Press the input box and enter the number using [▲] and [▼] or the numeric keys.
- To clear the fields, press the [Clear] key.
- If part of the printing area is missing due to the binding margin setting, press [Auto reduce].

3 Press [OK].

The settings are confirmed and the previous screen is displayed.

Paper folding

Select this when folding paper in two.



- The multifunction finisher is required to use this function.
- You cannot use "2-fold" and "Staple/Punch" at the same time.

<Size of paper that can be folded>

- A3, B4, A4, Ledger, Legal, Letter, Foolscap and custom size*

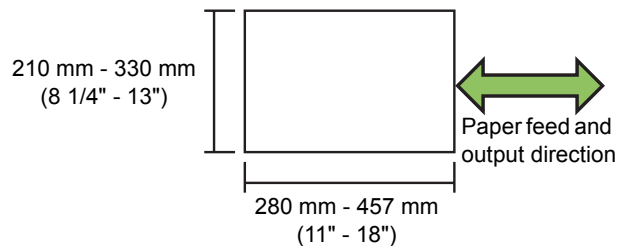

* The administrator must register the paper size in advance. Ask your administrator.

- Paper weight: 60 g/m² (16-lb bond) to 90 g/m² (24-lb bond)

■ Original orientation

[Top side up]

Select this when loading originals in an orientation from which they can be read normally.

[Top side left]

Select this when loading originals so that the top of the original is aligned with the left edge.

■ **Paper folding type**
[OFF], [2-fold]

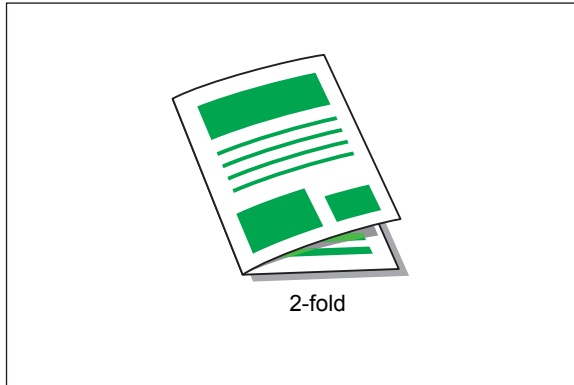

■ **Fold direction**

When you have selected [2-fold], specify which side is to be printed if the paper is folded.

[Print inside]

Simplex printing: Fold the paper with the printed surface on the inside.

Duplex printing: Fold the paper with the first page on the inside.

[Print outside]

Simplex printing: Fold the paper with the printed surface on the outside.

Duplex printing: Fold the paper with the first page on the outside.

1 Press [Functions] on the copy mode screen.

2 Press [Fold].

The [Paper folding] screen is displayed.

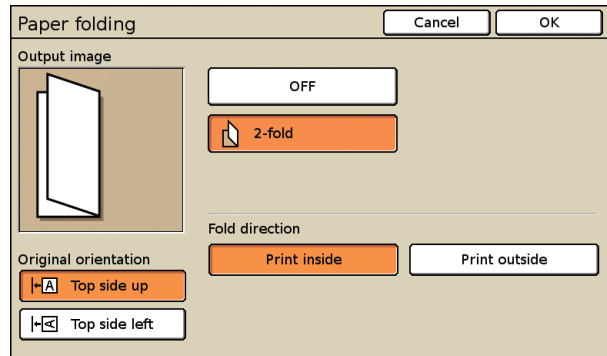

[Output image] displays an output image that reflects the settings.

3 Select the original orientation.

4 Select [2-fold].

5 Select the fold direction or binding side.

6 Press [OK].

The settings are confirmed and the previous screen is displayed.

Booklet

Create a booklet by performing duplex printing while imposing continuous pages and then folding the paper in two. The paper can also be bound in the center with staples.

- The optional multifunction finisher is required to use the [Paper folding] and [Fold + Staple] settings.
- You cannot use "Booklet" and "Mixed size original" at the same time. (p. 2-28 "Mixed size original")
- You cannot use "Booklet" and "Staple/Punch" at the same time. (p. 2-43 "Staple/Punch")

Types of paper that can be used to create booklets

Paper size: A3, B4, A4, Tabloid, Legal, Letter, Foolscap custom size*

* The administrator must register the paper size in advance. Ask your administrator.

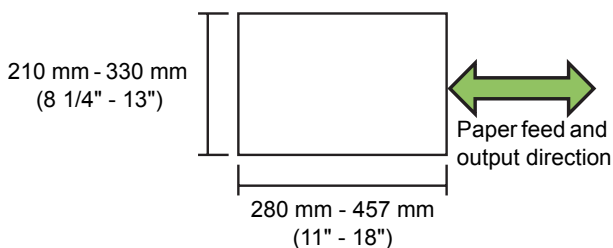

- Paper weight: 60 g/m² (16-lb bond) to 90 g/m² (24-lb bond)

Booklet setting

Specify the imposition, paper folding, and staple settings when creating a booklet.

[OFF]

Do not create a booklet. (Imposition only)

[Imposition]

Arrange the layout to create a booklet.

[Fold]

Paper is folded in two.

[Fold + Staple]

Paper is folded in two and bound in the center with staples.

Binding side

Specify the binding side of the paper.

[Left to right], [Right to left], [Top / Bottom]

Separate books

When you have selected [Paper fording] or [Fold + Staple], some restrictions apply to the number of sheets you can fold.

[Paper fording] creates a separate booklet every 5 sheets (20 pages), and [Fold + Staple], a booklet every 15 sheets (60 pages).

When the number of pages exceeds these numbers of sheets, one fold is made every number of sheets indicated above and the sheets are outputted (creating a separate booklet).

The layout order is different depending on whether center binding or side binding is performed for the separate stacks. Therefore, select [OFF] or [ON].

[OFF]

Data is imposed to create a book by opening, layering, and then binding the sheets (in the center). When [OFF] has been selected, the sheets are not stapled even if [Fold + Staple] is selected.

[ON]

Data is imposed to create a book by folding, layering, and then binding the sheets (on the side).

When "OFF" has been selected for [Separate books] and [Paper folding] has been set for a 60-page original

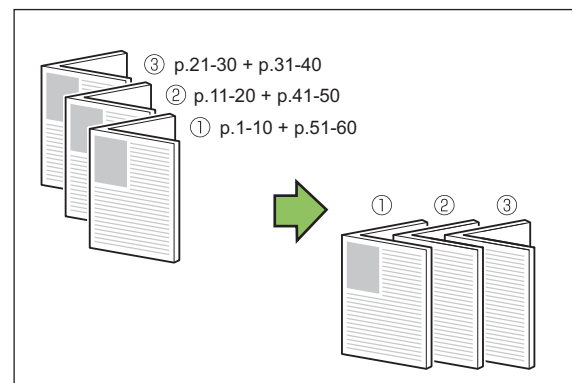

When "ON" has been selected for [Separate books] and [Paper folding] has been set for a 60-page original

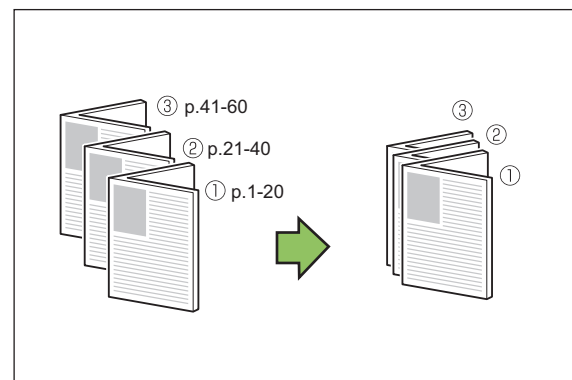

■ Center Margin and Auto Reduce

You can specify the center margin to the center of folded sections to prevent the folded sections from not being visible when folded in two. Specify the center margin between 0 mm and 50 mm (1 15/16") (in 1 mm units).

If a center margin you have specified would cause the printed image not to fit on the sheet, you can configure the image to be automatically reduced.

1 Press [Functions] on the copy mode screen.

2 Press [Booklet].

The [Booklet] screen is displayed.

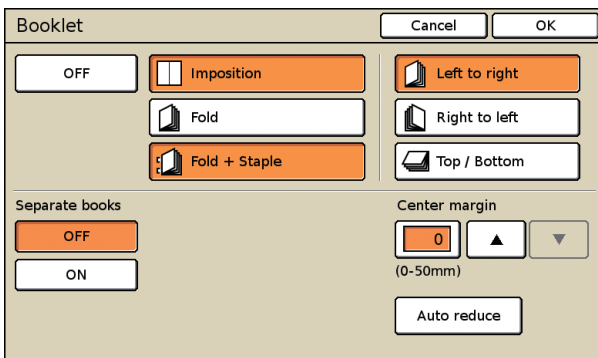

3 Select the booklet type.



When you have selected [Fold] or [Fold + Staple], [Imposition] is set to [ON] automatically. To disable Imposition, press [Imposition] and select [OFF].

4 Select the binding side.

5 Specify [Separate books].

6 Enter the center margin value.

- Press the input box and enter the number using [▲] and [▼] or the numeric keys.
- To clear the fields, press the [Clear] key.
- If part of the printing area is missing due to the center margin setting, press [Auto reduce].

7 Press [OK].

The settings are confirmed and the previous screen is displayed.

Output tray

Specify the output tray for the copies and output tray relay settings.

 An optional multifunction finisher or stacking tray is required to use this setting.

Selecting the Output Tray

Select the output tray for printouts.

[Auto]

The appropriate tray is selected automatically. When "Output tray relay" is set to [ON], select [Auto].

Output tray for optional equipment

Select the output tray.

 The buttons displayed on the [Output tray] screen varies depending on the optional equipment connected.

1 Press [Functions] on the copy mode screen.

2 Press [Output tray].

The [Output tray] screen is displayed.

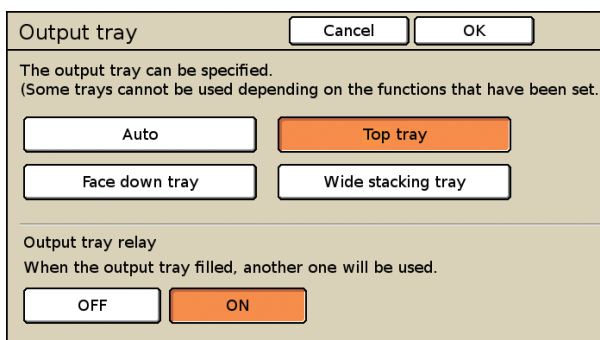

3 Select the output tray.

4 Press [OK].

The settings are confirmed and the previous screen is displayed.

Configuring the Output Tray Relay Setting

Switch the output tray automatically when the tray is full.

Select from the following.

[ON], [OFF]

-  An optional multifunction finisher or RISO auto-control stacking tray is required to use this setting.
- [Output tray] must be set to [Auto], and [Collate] must be set to [Group].

1 Display the [Output tray] screen.

Follow Steps 1 to 3 in "Selecting the Output Tray".

2 Press [ON] for [Output tray relay].

3 Press [OK].

The settings are confirmed and the previous screen is displayed.

Paper guide control

Adjust the position of the paper guides of the optional RISO auto-control stacking tray.

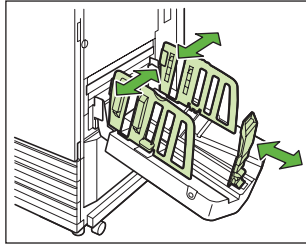

Automatic paper guide adjustment

Normally, select [Auto].

[Auto]

The position of the paper guides is adjusted automatically to fit the paper size.

Manual paper guide adjustment

You can widen or narrow the paper guides beyond the position set automatically.

You can adjust the side and end paper guides separately.

[Wider]

Each time you press the button, the paper guides move 1 mm (1/16") toward the outside of the stacking tray.

[Narrower]

Each time you press the button, the paper guides move 1 mm (1/16") toward the inside of the stacking tray.



You can also use the paper guides open button on the RISO auto-control stacking tray when manually removing paper from the tray.

See "Stacking Tray (optional)" (p. 8) in "Part Names and Functions" for details on using the paper guide open button on the RISO auto-control stacking tray.

1 Press [Functions] on the copy mode screen.

2 Press [Paper guide control].

The [Paper guide control] screen is displayed.

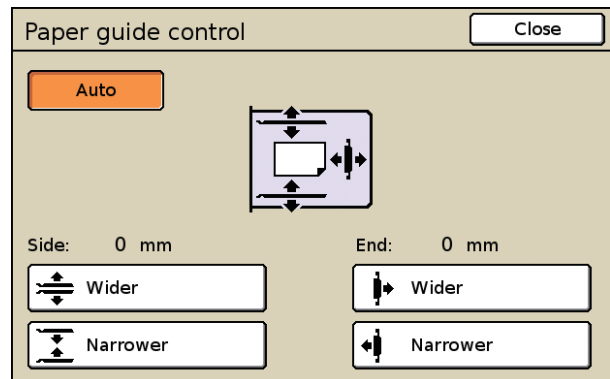

3 Adjust the positions of the paper guides.

The paper guide adjustment values are displayed on the screen.

- To reset the adjustment value to 0 mm, press [Auto].
- The adjustment value is also reset to 0 mm when the power is turned off, the [RESET] key is pressed, or the paper size is changed.

4 Press [Close].

The settings are confirmed and the previous screen is displayed.

Jump wing control

When using an optional stacking tray, you can adjust the position of the jump wings so that the paper is more evenly aligned. Normally, the position of the jump wings is adjusted automatically based on the paper type and size; however, the paper may not be evenly aligned depending on the paper used. In this case, specify jump wing control.

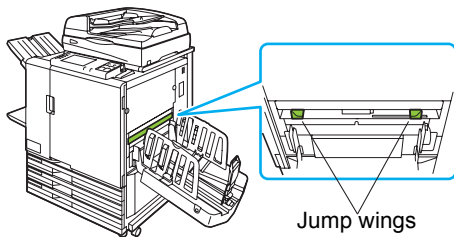

! This function is only displayed when the [Jump wing control] button has been registered in advance. To register this function or change the setting, contact your dealer (or authorized service representative).

1 Press [Functions] on the copy mode screen.

2 Press [Jump wing control].

[Jump wing control] is set.

Head cleaning

Clean the ink head when you notice a change in image quality, such as blurring in part of a copy, white streaking, or faded colors.

[Normal cleaning]

Head cleaning that is useful in preventing clogging.

[Strong cleaning]

Strong cleaning when the head is clogged.

! The administrator has set normal cleaning to be performed automatically after a set number of sheets is printed.

1 Press [Functions] on the copy mode screen.

2 Press [Head cleaning].

The [Head cleaning] screen is displayed.

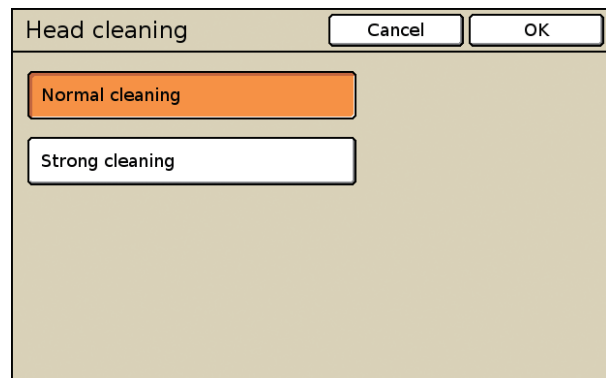

3 Select the type of head cleaning.

4 Press [OK].

The message "Cleaning in progress. Please wait a moment." appears. When head cleaning is completed, the previous screen is displayed.

Front doors release

Normally, you cannot open the front cover of the machine. When the front cover needs to be opened, such as when a paper jam occurs or an ink cartridge is empty, the front cover can be unlocked and opened.

To open the front doors in all other cases, press this button. The front cover is unlocked and can be opened.

When the front cover has been closed, it is locked when the machine starts operations.

Interrupt copy

Pause the job being printed to copy another job.

1 Press the [Interrupt] key.

The interrupting screen is displayed.

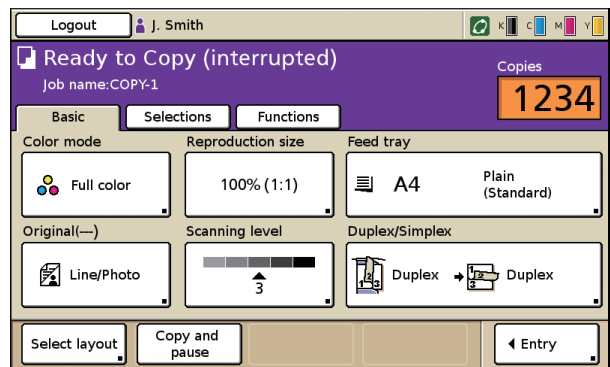

2 Load the original and press the [START] key.

- You can make copies continuously while "Ready to Copy (Interrupting)" is displayed in the message area.

3 After the interrupt copy has been completed, press the [Interrupt] key to cancel interrupt copy.

Printing of the paused job resumes.

- When the machine has not been operated for 60 seconds, interrupt copy is canceled.



- The following functions are not available for interrupt copy.
[Program], [Slip sheet], [Add cover], [ADF scan & pause], [Save to folder], [Save to archive], [PIN code]
- The following functions are not available when using interrupt copy to interrupt jobs being outputted to the multifunction finisher.
[Staple], [Punch], [Paper folding], [Booklet], [Add cover], [Separate books], [Binding margin]



3



Scanner

Overview of Scan Operations

You can scan a paper original to digitize it. You can also select the format of the scanned data according to how you want to use the data. Select [Format for PC] to read scanned images on a computer, to attach the data to e-mail messages or to save data to a USB flash drive. Select [Printable in this machine (save to folder)] to save images in a folder on the machine and print them when necessary.

Select the file format according to how you want to use the scanned image.

This chapter describes [Format for PC].

The optional scanner is required to use the scanning functions.



For information on [Printable in this machine (save to folder)], see "Save to folder" (p. 2-24) in "Copy".

Procedure

The scanning workflow is as follows.

1 Load the original

2 Select scanner mode

3 Select the file format

4 Select the directory

5 Configure the functions

6 Press the [START] key

● 1 Loading Originals

For information on the types of originals that can be used, see "Originals" in the "Safety Information".



Scanning area: 297 mm × 432 mm (11 11/16" × 17")

The machine cannot scan the area within 1 mm (1/16") of the edge of the paper.

(Any part of the image within this area will be lost.)

■ In the ADF

1 Load the original in the ADF.

Align the originals and place them face up.

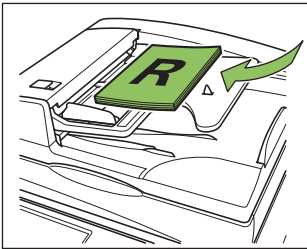

2 Slide the original guides to match the width of the originals.

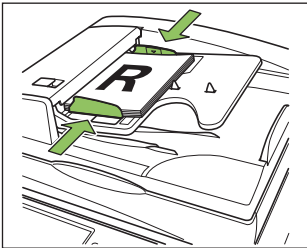

■ On the Platen Glass

Open the original cover and place the original on the glass surface.

1 Open the original cover.

2 Place the original.

Place the original face down on the glass. Align the corner of the original with the upper-left corner of the glass.

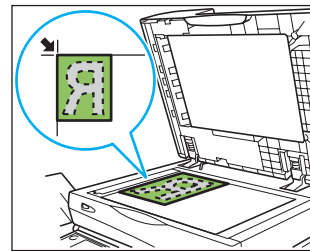

3 Close the original cover.



Open and close the original cover gently.

2 Selecting Scanner Mode

- 1 Press [Scanner] on the mode screen.

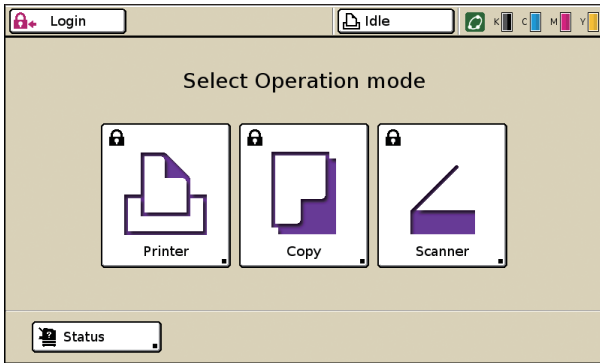

- Press the MODE key to display the mode screen.
- You may have to log in before the scanner mode screen is displayed.
- Buttons for modes that the current user is not authorized to use are grayed out.
- When using an optional IC card reader, you can log in by holding the IC card over the card reader.
- The mode buttons displayed vary depending on the optional equipment connected.

The screen for confirming the scanned data file format is displayed.

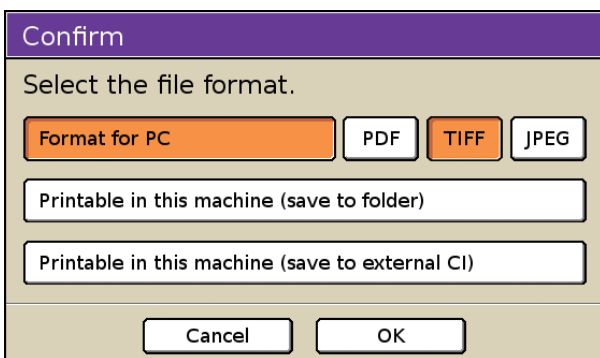

3 Selecting the File Format

■ [Format for PC]

Select the file format (PDF, TIFF, or JPEG). You can use the saved data as follows.

- Save data to the internal hard disk (Download using RISO Console.)
- Save data to a USB flash drive
- Save data to a computer on the network
- Attach data to an e-mail message

- 1 Press either [PDF], [TIFF], or [JPEG].

- 2 Press [OK].

The scanner mode screen is displayed.

■ [Printable in this machine (save to folder)]

The [Save to folder] screen is displayed.

Data is saved in folders on the machine and can be printed from the machine.

See "Save to folder" (p. 2-24) in "Copy" for details.

■ [Printable in this machine (save to external CI)]

[Printable in this machine (save to external CI)] is displayed when the optional external controller (ComColorExpress IS900C) has been connected to this machine. See "Save to archive" (p. 2-26) in "Copy" for details.

- The [Confirm] screen may not be displayed, depending on how the administrator has configured the settings. In this case, configure [File format] on the scanner mode screen. See "File format" (p. 3-9) for details.

4 Selecting the Directory

Specify the directory for saving scanned data.

The currently specified directory or e-mail destination is displayed in [Directory] on the scanner mode screen.

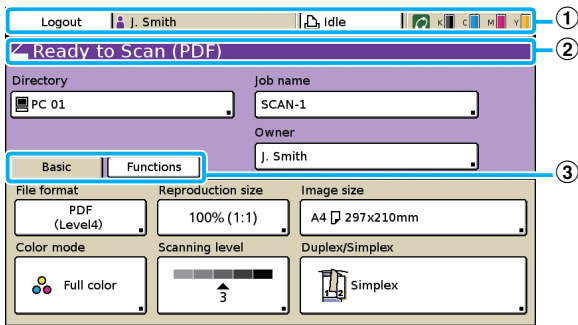

1 Status bar

Displays the login or logout button, user name, machine status (Printer Status Button), and remaining ink indicator.

2 Message area

Displays the file format and any messages.

3 Screen selection button

Displays the [Basic] or [Functions] screen.

Use the [Basic] screen to configure the basic scan settings.

Use the [Functions] screen to configure the scanning functions.

Save Data to the Internal Hard Disk

You can save scanned data to the internal hard disk of this machine. You can then download the saved data to a user's computer. See "[Scanner] Menu" (p. 5-13) in "RISO Console".

1 Press [Directory] on the scanner mode screen.

The [Directory] screen is displayed.

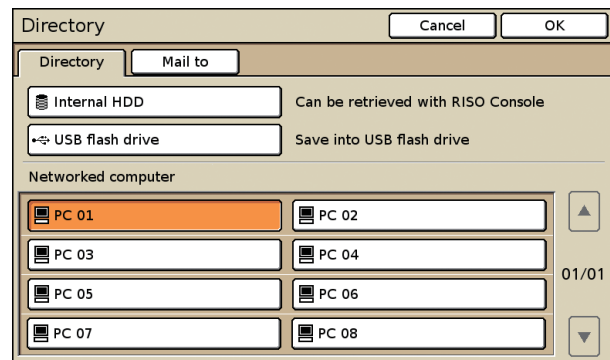

When the [Mail to] screen has been displayed, press [Directory].

2 Press [Internal HDD].

3 Press [OK].

The previous screen is displayed.



You can use the console to download and use data saved to the internal hard disk. (p. 5-14)
The storage period for scanned data is configured by the administrator.

Save Data to a USB Flash Drive

You can save scanned data to a USB flash drive connected to the USB port of the machine.



RISO KAGAKU CORPORATION is not responsible for the loss of any data on a USB flash drive when used with this machine. To protect your data, it is recommended that you backup your data in advance.



1 Insert the USB flash drive into the USB port of the machine.

For information on the USB port, see "Part Names and Functions" (p. 7).

2 Press [Directory] on the scanner mode screen.

The [Directory] screen is displayed.

If the [Mail to] screen is displayed, press [Directory].

3 Press [USB flash drive].

4 Press [OK].

The previous screen is displayed.



- Do not remove the USB flash drive until saving is finished.
- [USB flash drive] in the [Directory] screen is grayed out when no USB flash drive has been inserted into the USB port.

Save Data to a Computer on the Network

You can save scanned data to a computer on the network.

1 Press [Directory] on the scanner mode screen.

The [Directory] screen is displayed.

When the [Mail to] screen has been displayed, press [Directory].

A list of directories is displayed in [Networked computer].

2 Select the directory for the saved data.

Press [▲] and [▼] to scroll the list.

3 Press [OK].

The previous screen is displayed.



To save data to a computer not listed in [Networked computer], ask your administrator.

Attach Data to an e-mail Message

You can attach scanned data to e-mail messages and send them.

1 Press [Directory] on the scanner mode screen.

The [Directory] screen is displayed.

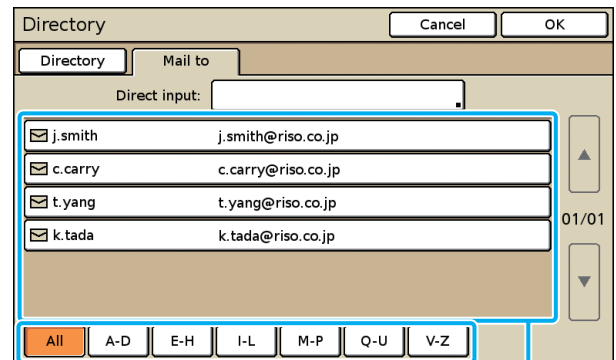

Index buttons

Mail destination list

When the [Directory] screen has been displayed, press [Mail to].

2 Select the mail destination.

<To select an address from the mail destination list>

1. Use the index buttons to narrow down the addresses that are displayed.
2. Press [▲] and [▼] to scroll the list, and select a destination from the mail destination list.

<To enter a destination directly>

1. Press the [Direct input] button to display the text input screen.
2. Enter the recipient's address.
 - Enter the recipient's address within 256 characters, and press [OK].
 - To erase the character to the left side of the cursor for entering a new character, press [Clear].



The administrator can register e-mail destinations. You may not be able to enter e-mail addresses directly, depending on how the administrator has configured the settings.

3 Press [OK].

The scanner mode screen is displayed.

■ **Save Scanned Data in Folders**

You can save scanned data to a folder.
 You can retrieve the data and print it when needed.
 For information on saving data to a folder, see "Save to folder" (p. 2-24) in "Copy".

● **5 Configuring the Functions**

Specify the detailed settings for scanning.
 For information on the functions that can be configured, see "List of Settings" (p. 3-8).

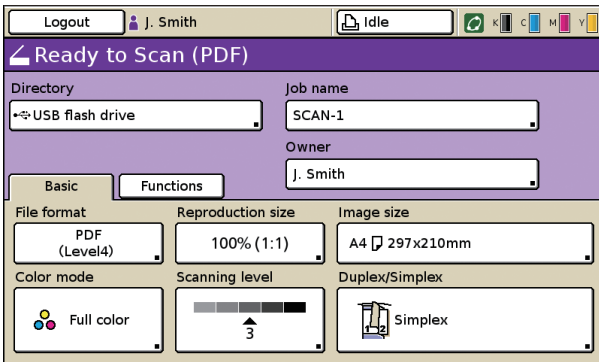

● **6 Press the [START] key**

The [Scanning] screen is displayed, and scanning of the original starts.

The current status, including the number of scanned pages, is displayed on the screen.

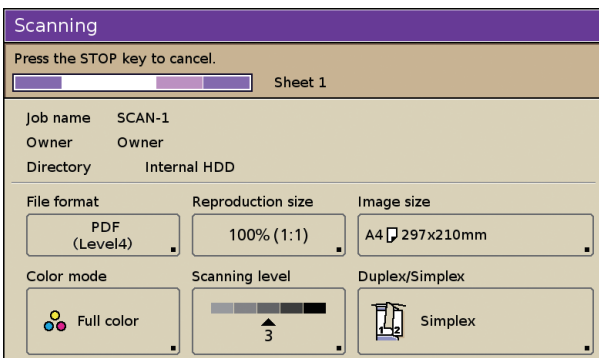

When scanning and saving have finished, the scanner mode screen is displayed.

■ **To cancel scanning:**

- 1 **Press the [STOP] key, or press [Cancel].**

Scanning is stopped and the scanner mode screen is displayed.

List of Settings

The following is a list of scanner mode settings.



- The buttons displayed on the screen vary depending on the selected item and how the administrator has configured the settings.
- An option setting is displayed only when optional equipment required for that setting has been connected.

	Setting	Description	See
[Basic]	File format	Specify the file format, compression level and resolution for saving the scanned data.	p. 3-9
	Reproduction size	Enlarge or reduce the scanned data.	p. 3-10
	Image size	Specify the page size for saving scanned data.	p. 3-10
	Color mode	Specify the color mode of the data to be scanned.	p. 3-11
	Scanning level	Adjust the scanning density for originals.	p. 3-12
	Duplex/Simplex	Specify sides of the original to be scanned.	p. 3-12
[Functions]	Check setting	Confirm and register the current settings, and print the settings information.	p. 3-13
	Save/Call setting	Up to 10 frequently used settings can be registered.	p. 3-13
	Original	Select the original type to perform the appropriate image processing and save the scanned data.	p. 3-13
	Book shadow erase	Remove shadows that appear in the center of copies when an open book is copied.	p. 3-14
	Scanning size	Specify the scanning size for originals to be scanned.	p. 3-14
	Mixed size original	Specify this when the original has multiple sizes.	p. 3-14
	Gamma control	Adjust the color balance (CMYK) of originals.	p. 3-14
	Image control	Specify the image processing appropriate for the original.	p. 3-14
	Base color level	Make the background color (base color) lighter so that the text is easier to read.	p. 3-14
	PIN code	Assign PIN codes when saving scanned jobs on the internal hard disk.	p. 3-15
Front doors release	Release the front door lock.	p. 3-15	

Basic Settings

Use the [Basic] screen to specify the basic settings for scanning.

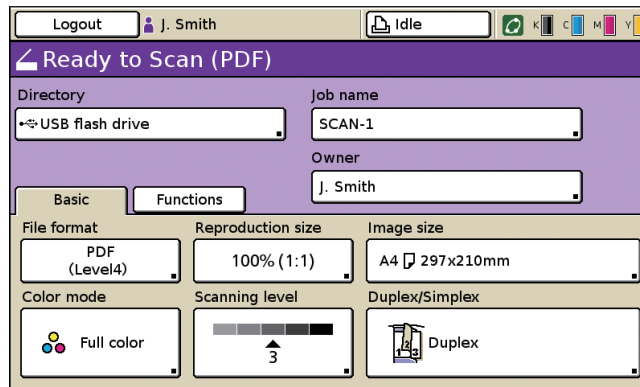

File format

Specify the file format, compression level, and resolution of scanned images.

■ File format

[PDF], [TIFF], [JPEG]

■ Data compression

Numerical scale from [1] Low compression (High quality) to [5] High compression (Low quality)

■ Resolution

[200dpi], [300dpi], [400dpi], [600dpi]



- When [400dpi] or [600dpi] has been selected, the scanned data cannot be enlarged/reduced.
- To save data to a folder, select "Save to folder" (p. 2-24) on the copy mode screen.

1 Press [File format] on the scanner mode screen.

The [File format] screen is displayed.

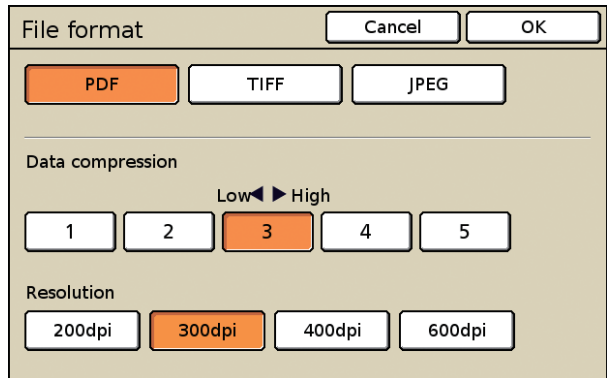

2 Specify the file format.

3 Specify the compression level.

- The lower the setting (toward [1]), the lower the compression and the higher the quality at which the scanned images are saved, and the higher the setting (toward [5]), the higher the compression and the lower the quality at which the scanned images are saved.

4 Specify the resolution.

5 Press [OK].

The settings are confirmed and the previous screen is displayed.

Reproduction size

Enlarge or reduce the scanned data.
For operations, see "Reproduction size" (p. 2-9) in "Copy".



When the resolution for "File format" is set to [400dpi] or [600dpi], the scanned data cannot be enlarged/reduced.

Image size

Specify the image size for saving scanned data.
Select a standard image size or enter an image size.





Selecting a Standard Image Size

Select from the following.

[Auto]

The scanned data is automatically enlarged or reduced depending on the original size and reproduction ratio.

Standard size

[A3], [A4], [A4 ], [A5], [A5 ], [A6], [B4], [B5], [B5 ], [B6], [Foolscap], [Ledger], [Legal], [Letter], [Letter ], [Statement], [Statement ], [C4], [C5], [C6], [DL-R], [Envelope 1], [Envelope 2], [No. 10 Envelope]

Registered custom sizes are also displayed.

1 Press [Image size] on the scanner mode screen.

The [Image size] screen is displayed.

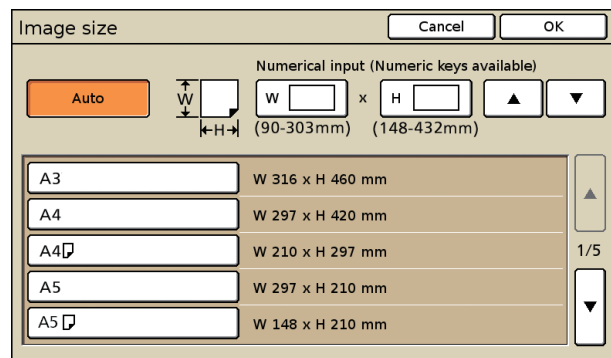

2 Select the image size.

3 Press [OK].

The settings are confirmed and the previous screen is displayed.

● Entering a Image Size

When the original is a non-standard size, you can specify the original size by entering the numerical value.

1 Press [Image size] on the scanner mode screen.

The [Image size] screen is displayed.

2 Enter the image size.

Press the input box and enter the number using [▲] and [▼] or the numeric keys.

Enter a number between 90 mm (3 9/16") and 303 mm (11 15/16") for the [W] field and between 148 mm (5 13/16") and 432 mm (17") for the [H] field.

- To clear the fields, press the [Clear] key.

3 Press [OK].

The settings are confirmed and the previous screen is displayed.

Color mode

Select the color mode of the data to be scanned.

[Auto]

The machine automatically determines if the original is in color or black and white. If it is determined that the original is in color, it is converted to RGB data and saved. If it is determined that the original is in black and white, it is converted to black data and saved.

[Full color]

Originals are converted to RGB data and saved.

[Grayscale]

Color originals or color photos are converted to grayscale data and saved.

[Black]

Originals are saved as black and white (binary) data.

1 Press [Color mode] on the scanner mode screen.

The [Color mode] screen is displayed.

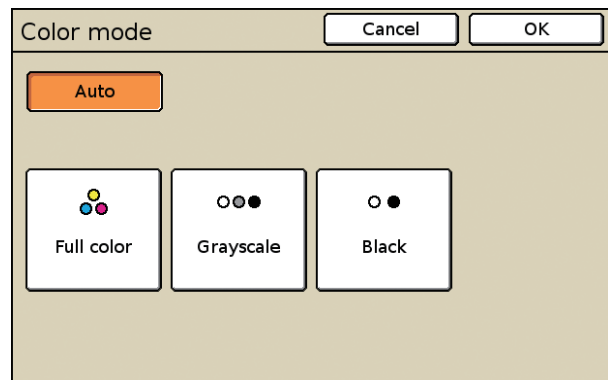

2 Select the color mode.

3 Press [OK].

The settings are confirmed and the previous screen is displayed.

Scanning level

Adjust the scanning density for originals.
For operations, see "Scanning level" (p. 2-13) in "Copy".

Duplex/Simplex

Specify the sides of the original to be scanned.

Original

[Simplex], [Duplex]

Paging Direction

When the original is two-sided, select how pages of the original are turned.

[Left / Right], [Top / Bottom]

Original orientation

[Top side up]

Select this when loading the original with the top of the original facing toward the back of the platen glass or the ADF.

[Top side left]

Select this when loading the original with the top of the original facing toward the left of the platen glass or the ADF (so that the text of the original is on its side).

1 Press [Duplex/Simplex] on the scanner mode screen.

The [Duplex/Simplex] screen is displayed.

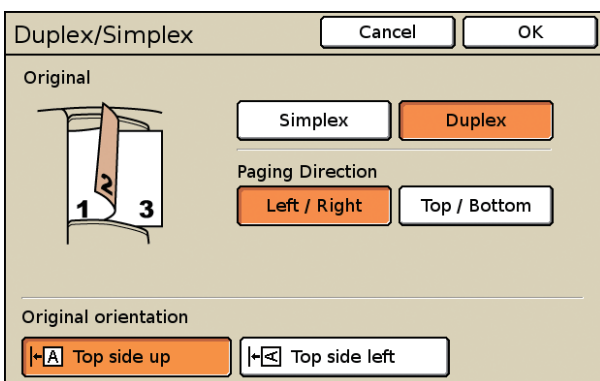

2 Specify the sides of the original to scan.

- When you have selected [Duplex], select how pages of the original are turned.

3 Select the original orientation.

4 Press [OK].

The settings are confirmed and the previous screen is displayed.

Scanning Functions

Check setting

You can confirm and register the scanner mode settings, and print the settings information. For operations, see "Check setting" (p. 2-18) in "Copy".

Save/Call setting

Register information for up to 10 frequently used settings. For operations, see "Save/Call setting" (p. 2-19) in "Copy". You can register the following settings in scanner mode.

- "Directory" (p. 3-5)
- "File format" (p. 3-9)
- "Reproduction size" (p. 3-10)
- "Image size" (p. 3-10)
- "Color mode" (p. 3-11)
- "Scanning level" (p. 3-12)
- "Duplex/Simplex" (p. 3-12)
- "Original" (p. 3-13)
- "Book shadow erase" (p. 3-14)
- "Scanning size" (p. 3-14)
- "Mixed size original" (p. 3-14)
- "Gamma control" (p. 3-14)
- "Image control" (p. 3-14)
- "Base color level" (p. 3-14)

Original

Select one of the following original types to perform the appropriate image processing and save the scanned data.

[Line/Photo]

Select this when the original has both text and photos.

[Line]

Select this when the original has text or illustrations.

[Photo]

Select this when the original has photos.

1 Press [Functions] on the scanner mode screen.

2 Press [Original].

The [Original] screen is displayed.

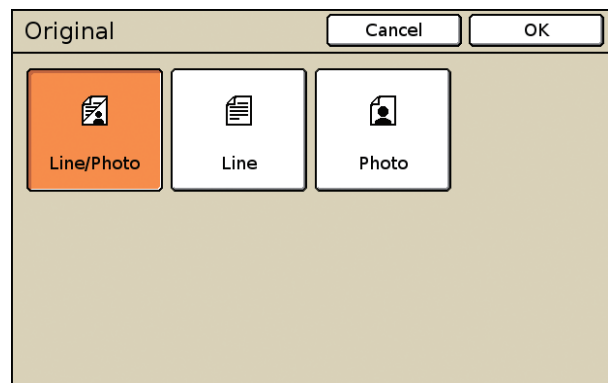

3 Select the original type.

4 Press [OK].

The settings are confirmed and the previous screen is displayed.

Book shadow erase

Remove shadows that appear in the center of copies when an open book is copied.
For operations, see "Book shadow erase" (p. 2-29) in "Copy".

Scanning size

Specify the size of the original to be scanned.
For operations, see "Scanning size" (p. 2-27) in "Copy".

Mixed size original

Specify this when the original has multiple sizes. The original sizes that can be used together are "A3 and A4-R", "B4 and B5-R" and "Ledger and Letter-R".
For operations, see "Mixed size original" (p. 2-28) in "Copy".



Originals with different sizes cannot be saved as a PDF with one page size. When [Mixed size original] is specified, be sure to set [Image size] to [Auto].

Gamma control

Adjust the color balance of scanned data.
For operations, see "Gamma control" (p. 2-34) in "Copy".



When [Color mode] has been set to [Grayscale] or [Black], the gamma value can only be adjusted for K. The gamma value cannot be adjusted between C and R, M and G, or Y and B. (See "Color mode" on p. 3-11)

Image control

Specify the image processing appropriate for the original.
For operations, see "Image control" (p. 2-35) in "Copy".

Base color level

Make the background color (base color) lighter so that the text is easier to read when scanning text originals with a background color or colored paper.
For operations, see "Base color level" (p. 2-35) in "Copy".

PIN code

Assign PIN codes when saving scanned jobs on the internal hard disk. The PIN code set here is required when using the RISO Console to download to a computer.

1 Press [Functions] on the scanner mode screen.

2 Press [PIN code].

The [PIN code] screen is displayed.

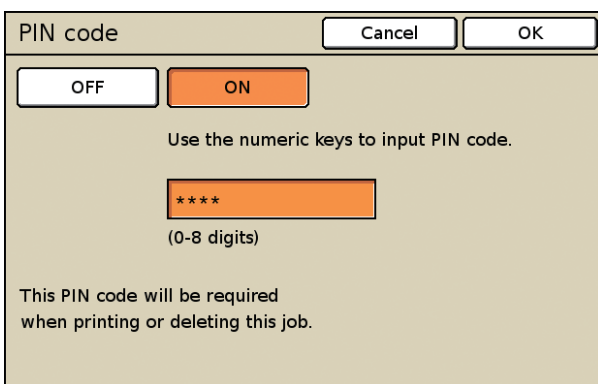

3 Press [ON].

4 Enter the PIN code.

Enter the PIN code (a number of up to eight digits) using the numeric keys.

- The entered PIN code is displayed with asterisks "*".
- To clear the fields, press the [Clear] key.

5 Press [OK].

The settings are confirmed and the previous screen is displayed.

Front doors release

Normally, you cannot open the front cover of the machine. When the front cover needs to be opened, such as when a paper jam occurs or an ink cartridge is empty, the front cover is unlocked and can be opened.

To open the front doors in all other cases, press this button. The front cover is unlocked and can be opened. When the front cover is closed, it is locked when the machine starts operations.



4



Printer

Overview of Printer Mode Operations

A list of jobs being processed for printing is displayed.

You can use this mode screen to control jobs whose data has already been sent to the machine but not yet printed.



- Each unit of processing for the print, copy, and other modes is called a "job".
- You cannot use this screen to control the data of [Format for PC].
(See "Overview of Scan Operations" (p. 3-2) in "Scanner" for creating scanned data and "Downloading Scanned Jobs to a Computer" (p. 5-14) in "RISO Console" for downloading scanned data.)

Procedure

The job operation workflow is as follows.

1 Select printer mode

2 Press the screen selection button

3 Select a job

4 Print a job

1 Selecting Printer Mode

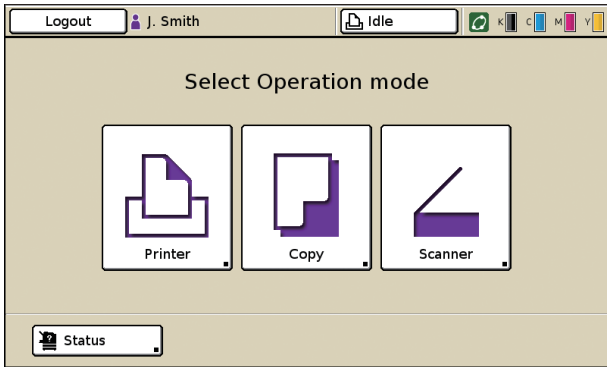

The printer mode screen is displayed.



- The displayed mode buttons vary depending on the optional equipment connected.
- To log in to the printer mode, you may be asked to enter your password for authentication.

2 Pressing the Screen Selection Button

Press the button of the location where the job to be controlled is saved, depending on the intended use.

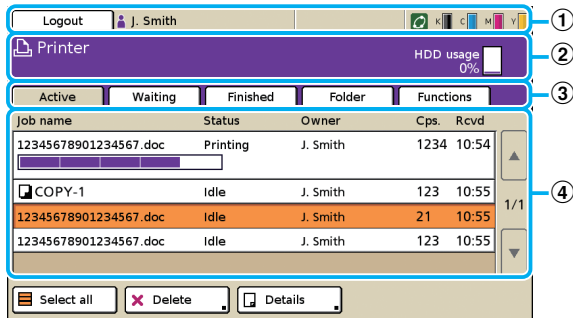

1 Status bar

Displays the login or logout button, user name, machine status, and remaining ink indicator.

2 Message area

Displays a message and the hard disk usage.

3 Screen selection buttons

Switch between the [Active], [Waiting], [Finished], [Folder] and [Functions] screens.

4 Job list

Displays the job name, status, owner name, number of copies, and receiving time for jobs.

■ HDD Usage

The used internal hard disk space is displayed in the message area using a 10-bar scale.

When the hard disk usage exceeds 91% and the display begins to blink, delete any unnecessary data to free up hard disk space.



Less than 20% used More than 51% used More than 91% used

3 Selecting a job

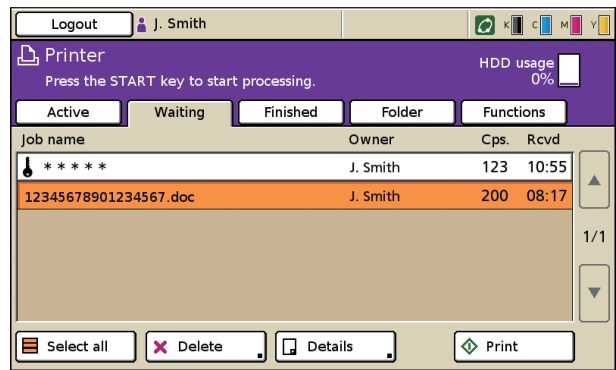

Icons Displayed in the Job Name



Copied job



Job with a PIN code

None

Other job (such as job sent using the printer driver or job retrieved from a folder)

Operation Buttons



A button is not available when it is grayed out.

[Select all]

Select all jobs (except jobs with PIN codes) displayed in the list.

[Delete]

Delete the selected job from the list.

[Details]

Display the details of the selected job.

There are two [Details] screens. The buttons that are available on the [Active], [Waiting], [Finished], and [Folder] screens vary.

When a button is grayed out, you can confirm the current setting but cannot change it.

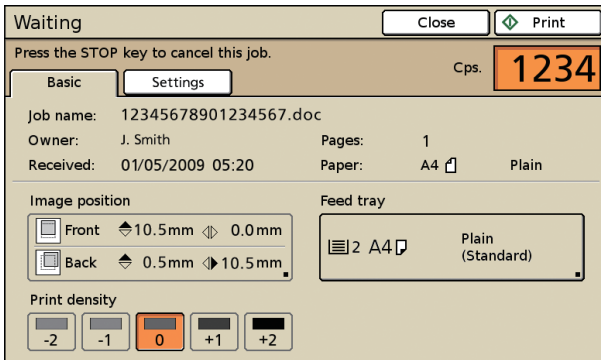

Pressing [Print this list] prints a list of the settings (on A4/Letter paper).

4 Printing a job

Press [Print]. The selected job is printed. Depending on the job, the screen asking you to enter the PIN code may appear. Follow the displayed instructions.

List of Settings

	Setting	Description	See
[Active]	Delete, Print, Details	Confirm details of, print, and delete active jobs.	p. 4-6
[Waiting]		Confirm details of, print, and delete waiting jobs.	p. 4-7
[Finished]		Confirm details of, print, and delete finished jobs.	p. 4-8
[Folder]		Confirm details of, print, and copy jobs in a folder.	p. 4-9
[Functions]	Online	Set the machine online or offline.	p. 4-14
	Feed tray	Specify the feed tray, paper size, feed control, and double feed check settings for each feed tray.	p. 4-14
	Head cleaning	Clean the ink heads.	p. 4-15
	Paper guide control	Adjust the paper guide position of the RISO auto-control stacking tray. (When using the optional RISO auto-control stacking tray)	p. 4-15
	Jump wing control	Adjust the position of the jump wings. (When using the optional stacking tray)	p. 4-15
	Front doors release	Release the front door lock.	p. 4-15

Managing Jobs

This section describes how to confirm details of, print, and delete jobs on the job list of each screen.

[Active] Screen

Press [Active] to display the [Active] screen.

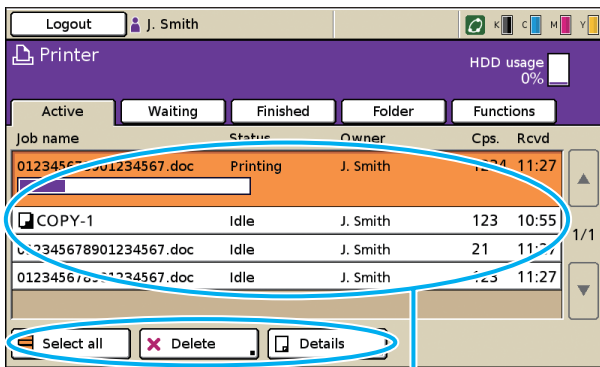

Operation buttons

Active job list

The jobs that are being printed and the jobs that are waiting to be printed are displayed. The jobs displayed in the job list are automatically printed in order from top to bottom.

- The job list displays the job name, status, owner name, number of copies, and receiving time for jobs that are being printed, processing, and waiting to be printed.
- The current status of the job being printed is displayed with a status bar.
- You can change the settings of jobs being printed. (p. 4-6 "Changing Settings During Printing")
- For information on the operation buttons, see "Operation Buttons" (p. 4-4).



Output order (order of job priority) of the "active job list"

Print jobs operated from the machine have higher priority over direct print jobs sent from a computer by a user who is not logged in. When copying is performed on the machine, the copy job has higher priority over jobs sent from the printer driver. Next, the job selected in the waiting list has priority.

Changing Settings During Printing

1 Press the [STOP] key.

The confirmation screen is displayed.

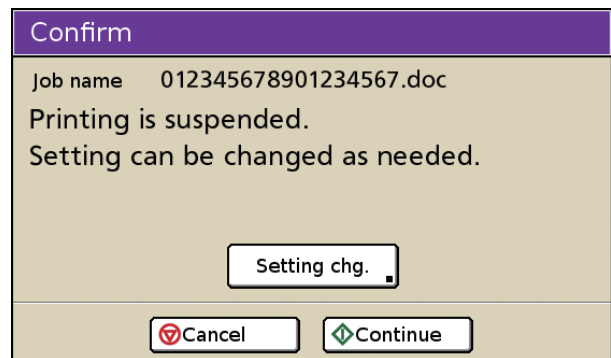

- Press [Cancel] to stop printing and delete the job.
- Press [Continue] to continue printing.

2 Press [Setting chg.]

The [Suspending] screen is displayed.

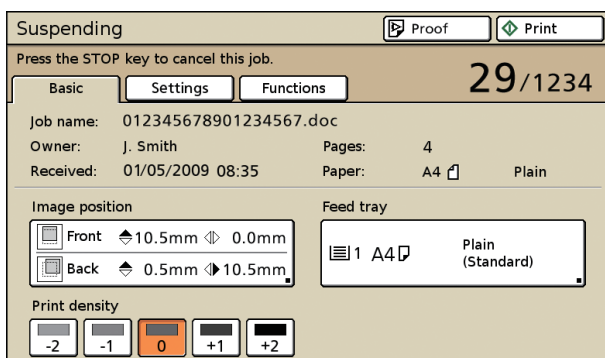

You can use the [Basic] screen on the [Suspending] screen to modify the following settings.

- "Image Position" (p. 4-12)
- "Feed tray" (p. 4-13)
- "Print density" (p. 4-13)



- To view the settings, press [Settings].
- You can enter a job comment that is displayed in a list of the settings on the printer driver. (p. 1-10 "Output and Destination" in "Printer driver")

3 Modify the settings as needed, and then press [Print].

Printing of the job with modified settings starts.

- To print the previously printed sheet with the modified settings, press [Proof].

[Waiting] Screen

Press [Waiting] to display the [Waiting] screen.

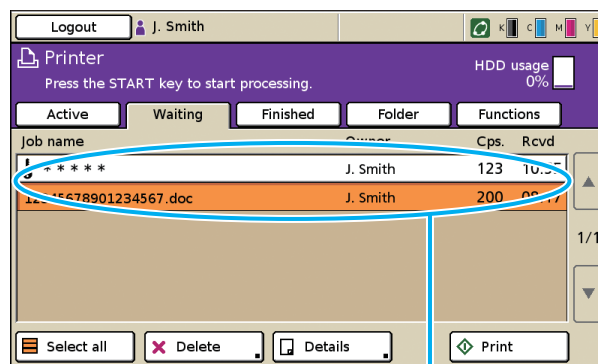

Waiting job list

This list displays jobs awaiting commands from the operation panel in order to be printed.

- The job list displays the job name, owner name, number of copies, and receiving time.

Jobs that require commands

- Jobs with a PIN code (with the  icon) (The PIN code must be entered.)
- All jobs sent from a computer when login is necessary in printer mode*
 - * Depending on the administrator settings, printing may be performed simply by logging in. (In this case, the job is not displayed in the waiting job list.)



- When the job name exceeds the character limit, the first half of the job name is omitted and the job name is displayed as "...xyz.doc".
- In the following cases, all job names are displayed.
 - When user login is not necessary
 - When the user with administrative authority is logged in
- In the following cases, the job name is displayed as "*****".
 - Jobs with the "Hide job name" check box selected on the printer driver (p. 1-27 "PIN code" in "Copy")
 - Jobs with a job name that is closed and requiring login

Meaning of Icons Displayed in the Job Name
(p. 4-3 "Icons Displayed in the Job Name")

Operation Buttons



A button is not available when it is grayed out.

[Select all]

Select all jobs (except jobs with PIN codes) displayed in the list.

[Delete]

Delete the selected job from the list.

[Details]

Display the details of the selected job.
(p. 4-4 "[Details]")

[Print]

Print the selected job. (The job will be listed in the active job list.)



Jobs printed from the waiting job list are displayed after jobs that are active and being processed in the active job list. Even if a job has been sent using the printer driver, a job printed from the waiting job list is printed immediately as long as there are no jobs that are active or being processed.

Jobs with a PIN Code

Select a job with a PIN code and press [Print] to display the PIN code input screen. Enter the PIN code and press [OK].

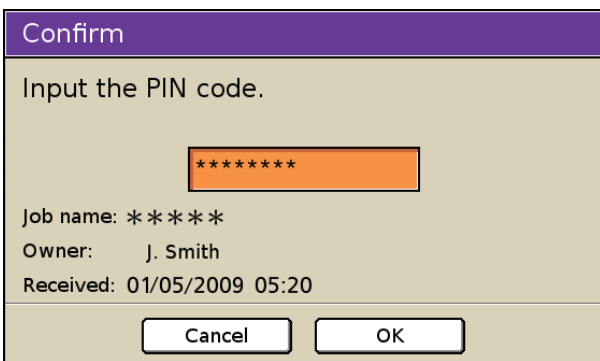

[Finished] Screen

Press [Finished] to display the [Finished] screen.

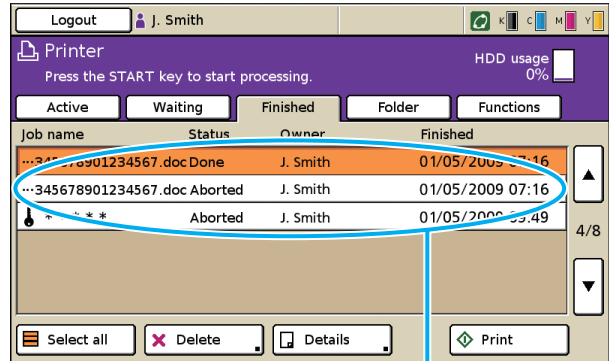

Finished job list

Jobs for which printing is finished are displayed in this list.

This list also displays a history of processed jobs, and the save period and number of jobs displayed in the list is specified by the administrator.

- The job list displays the job name, status, owner name, and end printing date for jobs for which printing is finished and for jobs that finished due to errors.

Operation Buttons



Some functions may not be available, depending on how the administrator has configured the settings. (Buttons for these functions are grayed out.)

[Select all]

Select all jobs (except jobs with PIN codes) displayed in the list.

[Delete]

Delete the selected job from the list.

[Details]

Display the details of the selected job.
(p. 4-4 "[Details]")

[Print]

Reprint the selected job. (The job will be listed in the active job list.)



- Copy jobs in the finished job list cannot be reprinted.
- Printing may be restricted by the administrator. (In this case, the list and [Print] button are grayed out.)

[Folder] Screen

Press [Folder] to display the [Folder] screen.

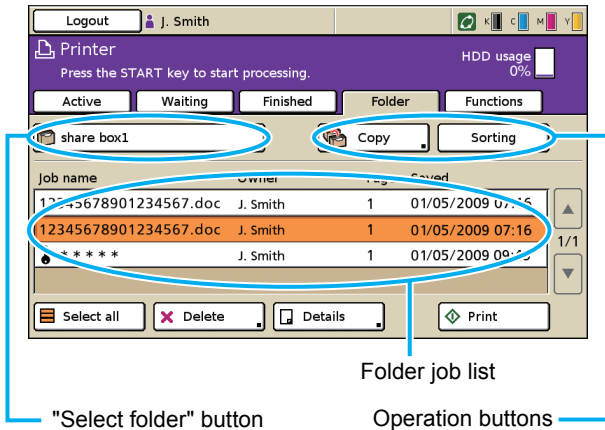

The jobs saved to the folder are displayed. Press "Select folder" and select the folder with the list you want to display.

- The job list displays the job name, owner name, number of pages, and saved date for jobs saved to the shared and personal folders.

Jobs Saved to Folders

- Jobs for which [Save to folder] has been set on the [Output] pull-down menu of the printer driver
- Jobs for which [Save to folder] has been set in copy mode
- Jobs for which [Printable in this machine (save to folder)] has been set on the confirmation screen of scanner mode



- The folder function may not be available, depending on how the administrator has configured the settings.
- Personal folders are displayed when login is necessary.
- Shared folders are registered by the administrator.

Operation Buttons



Some functions may not be available, depending on how the administrator has configured the settings. (Buttons for these functions are grayed out.)

[Select all]

Select all jobs (except jobs with PIN codes) displayed in the list.

[Delete]

Delete the selected job from the list.

[Details]

Display the details of the selected job.

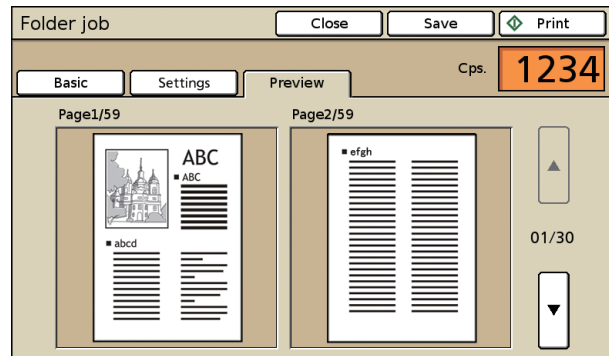
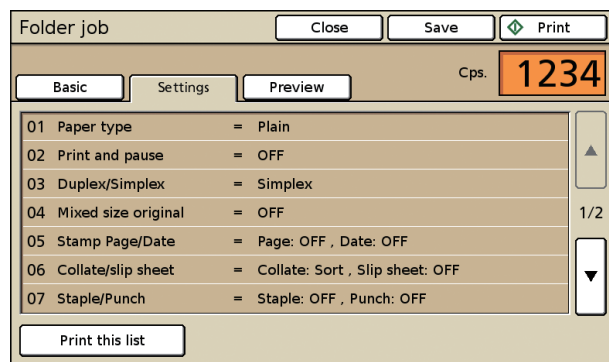
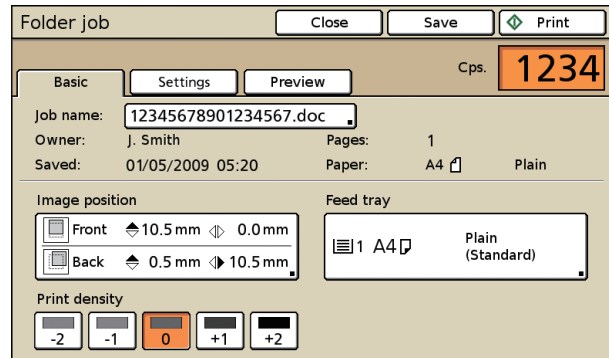

You can use the printer driver setting to enter job comments to be displayed on the [Settings] screen. (p. 1-10 "Output and Destination" in "Printer driver")

[Print]

Print the selected job.

[Copy]

Copy the selected job to another folder.

[Sorting]

Change the display order of the currently displayed list.

● Printing Jobs Stored in Folders



When the destination folder of the job to be printed has already been selected, start from Step 4.

- 1 On the [Folder] screen, press "Select folder" button.**

The [Select folder] screen is displayed.

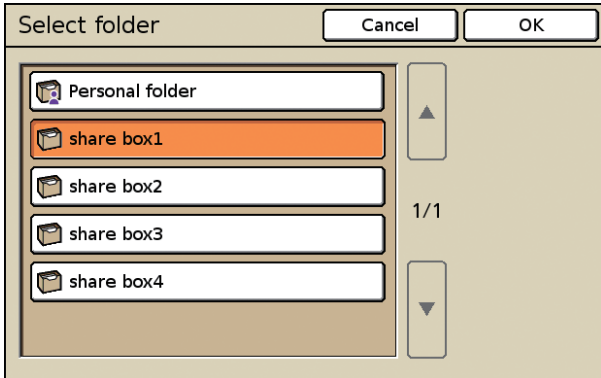

- 2 Press the folder where the job to be printed is saved.**

- 3 Press [OK].**

The [Folder] screen is displayed and then the job list for the selected folder is displayed.

- 4 Select a job.**

Press the job to be printed.

- To cancel the selection, press again.



Data for the job is saved in the folder together with the settings. When printing the job, use the same paper type as that used when saving the data in the folder.

The printing result varies with the paper type.



Pressing [Details] will display the preview screen so you can check the print image.

- 5 Press [Print].**

The selected job is moved to the active job list and printed.

- When printing a job with a PIN code, on the screen with the message "Input the PIN code.", use the numeric keys to enter the PIN code (a number up to eight digits) set for that job and press [OK].

● Copying a Job to Another Folder



When the destination folder of the job to be copied has already been selected, start from Step 4.

- 1 On the [Folder] screen, press "Select folder" button.**

The [Select folder] screen is displayed.

- 2 Select the folder where the job to be copied is saved.**

- 3 Press [OK].**

The [Folder] screen is displayed and then the job list for the selected folder is displayed.

- 4 Select a job.**

Press the job to be copied.

- To cancel the selection, press again.



Pressing [Details] will display the preview screen so you can check the print image.

- 5 Press [Copy].**

The [Copy to] screen is displayed. Select the folder to which to copy the job.

- Only the folders accessible to the logged in user are displayed on the [Copy to] screen.

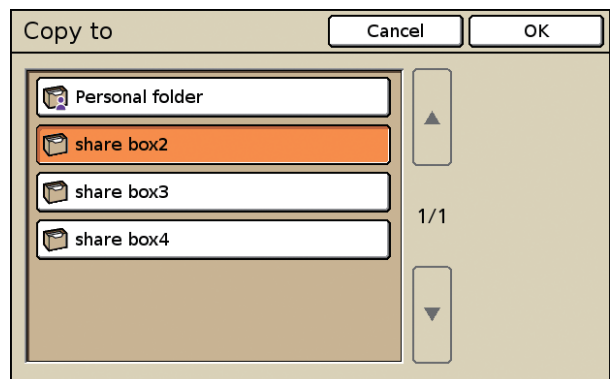

- 6 Press [OK].**

The selected job is copied (saved).

● Sorting the Job List

- 1 On the [Folder] screen, press "Sorting" button.

The [Sorting] screen is displayed.

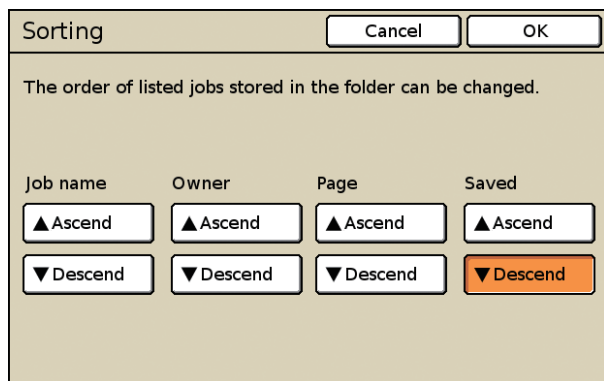

- 2 Select the sorting parameter ([Job name], [Owner], [Page], or [Saved]) and press [Ascend] or [Descend] below that parameter.

- 3 Press [OK].

The displayed list is sorted by the selected parameter.

Changing Finished Job and Folder Job Settings

- 1 Display the job list.

Press the screen selection button of the job list to be displayed.

- 2 Select the job with the settings to change.

- When you select multiple jobs, you cannot press [Details].
- To cancel the selection, press again.

- 3 Press [Details] and change the settings.

The [Details] screen is displayed. You can change the following settings.

- "Image Position" (p. 4-12)
- "Feed tray" (p. 4-13)
- "Print density" (p. 4-13)

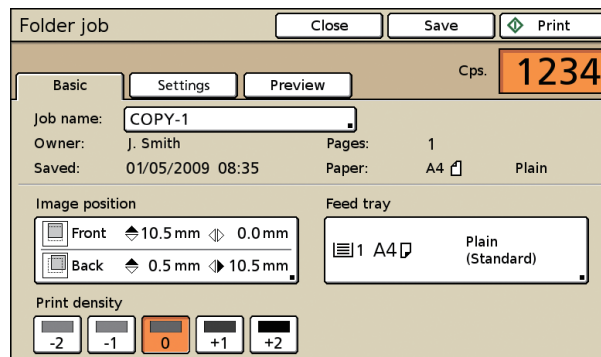

On the [Details] screen of a folder job, you can rename the job and save it.

4 Printer



- To view the current settings, press [Settings].
- To preview the print image of a folder job, press [Preview].

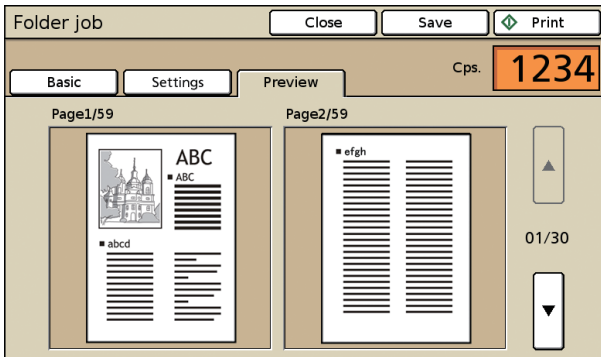

4 Press [Print] or [Save].

The specified operation is executed.

● Image Position

Adjust the printing position of images. You can adjust the printing position ± 20 mm (13/16") up, down, left, or right. When performing duplex printing, the front and back sides can be adjusted separately.

When you adjust the image position, an illustration indicating the adjusted image position is displayed.



Move up 0.5 mm (0.02") each time the button is pressed.



Move down 0.5 mm (0.02") each time the button is pressed.



Move to the right 0.5 mm (0.02") each time the button is pressed.



Move to the left 0.5 mm (0.02") each time the button is pressed.



Reset all adjusted positions to 0 mm.

1 Press [Image position] on the [Details] (or [Suspending]) screen for the selected job.

The [Image position] screen is displayed.

2 Press [\blacktriangle][\blacktriangledown] [\blacktriangleleft] or [\blacktriangleright] to adjust the image position.

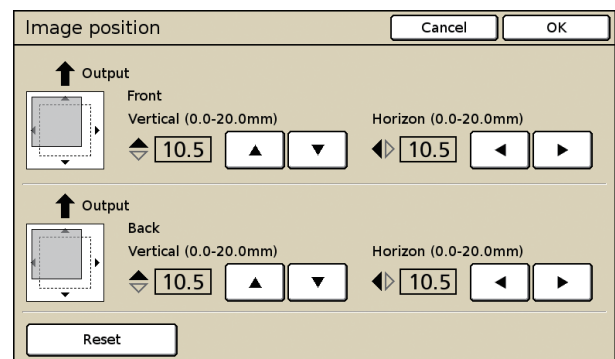

3 Press [OK].

The settings are confirmed and the previous screen is displayed.

● Feed tray

You can select the feed tray to use and configure the paper size and paper type settings.
For operations, see "Feed tray" (p. 2-9) in "Copy".

● Print density

Adjust the print density.

[-2]	Light
[-1]	Somewhat light
[0]	Standard
[+1]	Somewhat dark
[+2]	Dark

1 Select [Print density] on the [Details] (or [Suspending]) screen for the selected job.

- The lower the setting, the lighter the print density. The higher the setting, the darker the print density.

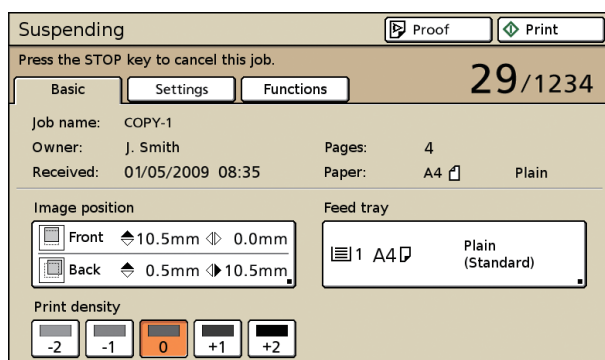

Printer Function Settings

Use the [Functions] screen to configure the user-configurable functions of the main unit (system).

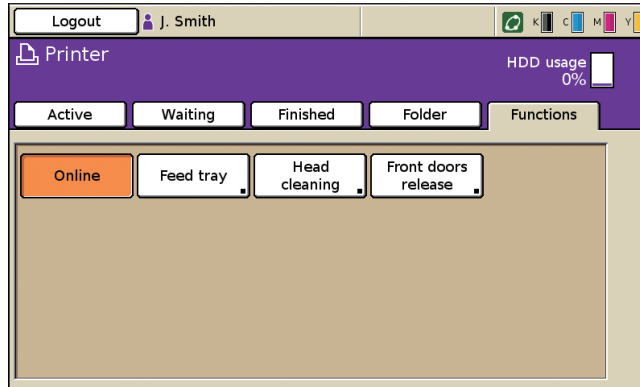

Online

Set the machine online or offline. When you set the machine offline, the machine cannot receive print commands from a computer. Set this for exclusive use of the machine.



- When the machine is offline, [Offline] is displayed in the status button.
- If the machine has not been online after printing, the machine is set online automatically in the following cases.
 - When auto reset is executed (The auto reset timing is set by the administrator.)
 - When you log out

Feed tray

Specify the paper size, paper type, paper feed, and double feed check settings for each feed tray.

- 1 Press [Functions] on the printer mode screen.

- 2 Press [Feed tray].

The [Feed tray] screen is displayed.

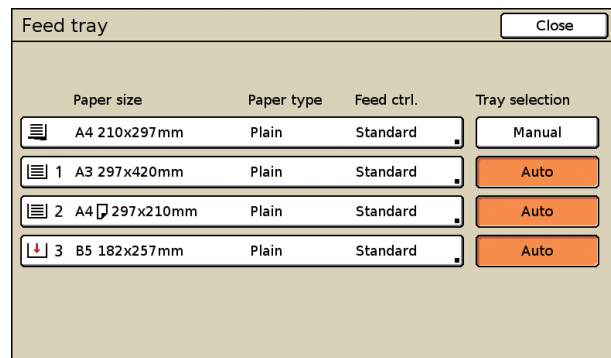

- 3 Select the feed tray.

The [Details] screen for the tray is displayed. Specify the paper size and paper type.



See "Feed tray" (p. 2-9) in "Copy" for details.

Head cleaning

Clean the ink heads when you notice a change in image quality, such as blurring in part of a printout, white streaking, or faded colors.

For operations, see "Head cleaning" (p. 2-51) in "Copy".

Paper guide control

Adjust the position of the paper guides of the optional RISO auto-control stacking tray.

For operations, see "Paper guide control" (p. 2-50) in "Copy".

Jump wing control

When outputting printouts to an optional stacking tray, you can adjust the position of the jump wings so that the paper is more evenly aligned.

Normally, the position of the jump wings is adjusted automatically based on the paper type and size; however, the paper may not be evenly aligned depending on the paper used. In this case, specify jump wing control.

For operations, see "Jump wing control" (p. 2-51) in "Copy".

Front doors release

Normally, you cannot open the front cover of the machine. When the front cover needs to be opened, such as when a paper jam occurs or an ink cartridge is empty, the front cover can be unlocked and opened.



To open the front doors in all other cases, press this button. The front cover is unlocked and can be opened. When the front cover is closed, it is locked when the machine starts operations.

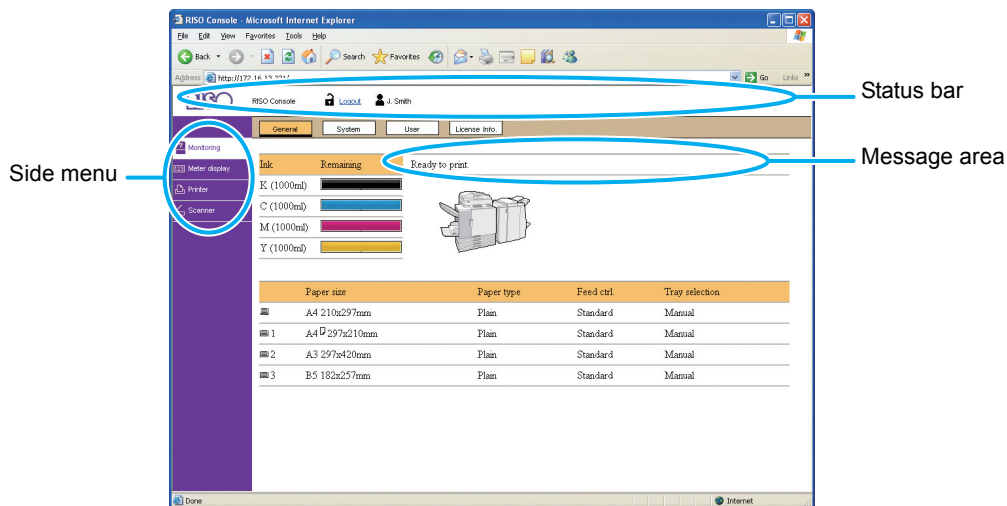

Overview of the RISO Console

The RISO Console is software that uses a Web browser to remotely control this machine. With a computer connected to the printer via local area network, you can check the printer status, change the settings of a job, and perform other operations.



- When an item on the side menu has the  icon, this indicates that you must login before you can access that item. When an item has the  icon, this indicates that access to that mode is restricted.
- Make sure the machine has been connected to the network.
- The Web browsers that support the RISO Console are Microsoft[®] Internet Explorer 6.0 (SP 1 or later) and Windows[®] Internet Explorer 7.0.
- The screens displayed vary depending on the operating system used and the optional equipment connected.
- The actual displayed content may be different from the above screenshot, depending on how the administrator has configured the settings.
For details, ask your administrator.

Select an item from the side menu of the RISO Console to perform the following operations.

Menu Name	Description	See
Monitoring	<ul style="list-style-type: none"> • Check the status of the printer. • Check the status of the consumables, such as the remaining amount of ink or paper. • Check the printer model, serial number, IP address, and other system information. • Check information about the user currently logged in. 	p. 5-4
Meter display	<ul style="list-style-type: none"> • Check the use conditions, limit of number of printable sheets, and charge count for users. 	p. 5-7
Printer	<ul style="list-style-type: none"> • Check the job list and change the job settings. 	p. 5-9
Scanner	<ul style="list-style-type: none"> • Check and download scanned jobs saved to the internal hard disk drive. 	p. 5-13

Starting the RISO Console

- 1 Start your Web browser.
- 2 Enter the IP address of the printer in the address box of your Web browser.

- Ask your administrator for the IP address of the printer.

<Example of how to enter the IP address "192.168.1.99">

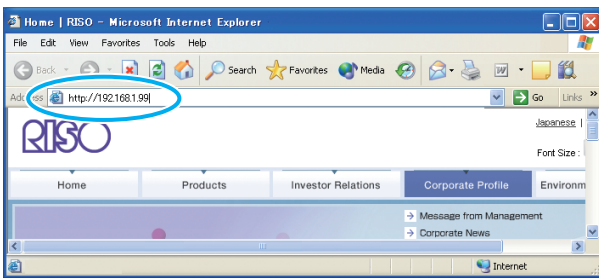

- You can access the RISO Console when the computer is connected to the printer by a local area network. Connection to the Internet is not required.

3 Press the [Enter] key.

The [Monitoring] screen of the RISO Console is displayed.

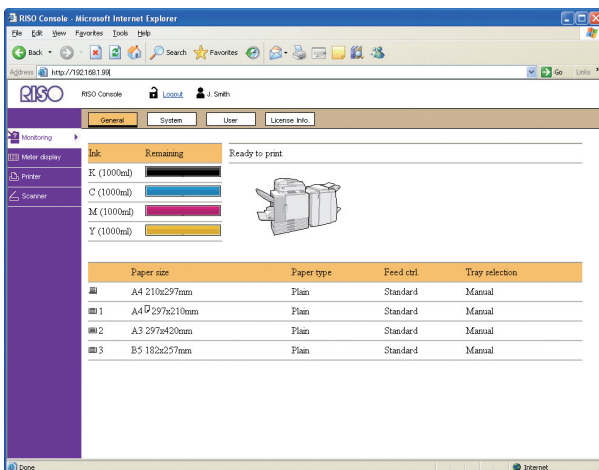

- You can create a shortcut on the desktop to easily display the RISO Console screen.

When Login is Necessary

Click [login] to display the login screen of the RISO Console.

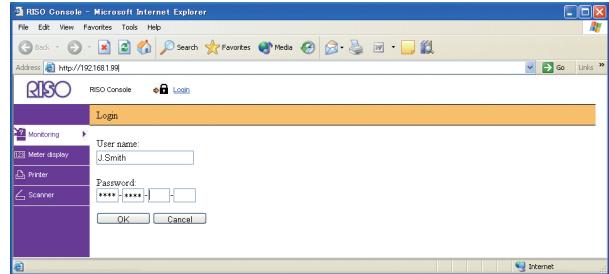

Enter the user name and password and click [OK] to display the [Monitoring] screen.

- Enter a password of between 0 and 16 alphanumeric characters long. The entered characters are displayed with asterisks (*).
- To logout, click [Logout].
- When the user is logged in with administrative authority, [Admin mode] is displayed to the right of the user name.

- If you forget the password, ask your administrator.
- You can change the user password on the [User] screen of the [Monitoring] screen. (p. 5-5 "[User] Screen")

[Monitoring] Menu

You can click [Monitoring] on the side menu to check paper and ink information, system information, and user information.

[General] Screen

The [General] screen displays the printer status. This screen displays information on the machine and its consumables.

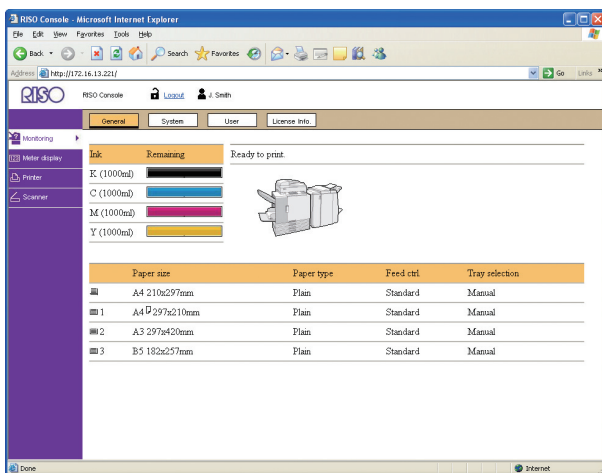

● Remaining Ink Indicator

The amount of remaining ink in the four ink cartridges is displayed using a 10-bar scale.

When the remaining amount of ink decreases to 9% or less, the display flashes. Prepare a new ink cartridge.

Cyan ink (1000 ml bottle)(10-bar scale):

Icon	Remaining Ink
	90%-100%
	80%-89%
	70%-79%
	60%-69%
	50%-59%
	40%-49%
	30%-39%
	20%-29%
	10%-19%
(flashes)	0%-9%



- The remaining ink indicator varies depending on the size of the ink bottle (500 ml or 1,000 ml bottle).
- The amount of remaining ink is not displayed when using Non-Riso ink.

● Printer Status

Displays a message indicating the current printer status ([Ready to print.], [Sleeping.], etc.).

If an error occurs, the error code is displayed here.

● Paper

Displays the estimated amount of remaining paper (three levels for feed tray 1 to 3 and five levels for the standard tray), the paper size, paper type, feed control, and tray selection.

When or is displayed, this indicates that there is no paper. Load paper.

Standard Tray (5 levels):

Icon	Remaining Ink
	51%-100%
	31%-50%
	11%-30%
	1%-10%
	0%

Feed Tray 1-3 (3 levels):

Icon	Remaining Ink
	51%-100%
	1%-50%
	0%

For the paper settings, see "Changing the Feed Tray Setting" (p. 2-10) in "Copy".

[System] Screen

The [System] screen displays the serial number, used internal hard disk space, and other system information.

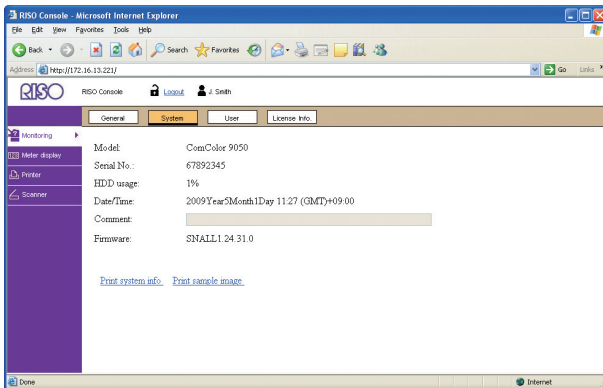

- Model: Machine model
- Serial No.: Machine serial number
- HDD usage: Ratio of used internal hard disk space
- Date/Time: Date and time of the machine's internal clock
- Comment: Comments entered by the administrator
- Firmware: Version of the firmware



Only users with administrative authority can enter comments in the [Comment] field.

- [Print system info]
Click this to print the system information.
- [Print sample image]
Click this to print a sample page so you can check the result of a printed image.

[User] Screen

The [User] screen displays information about the user currently logged in.



[User] is not displayed when login is not required.

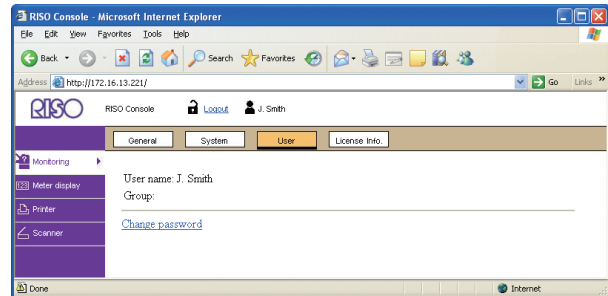

- User name
- Group



The displayed information is registered by the administrator. If the actual information is different, ask your administrator.

Changing the User Login Password

5

The user can change the login password.



Click [Change password].

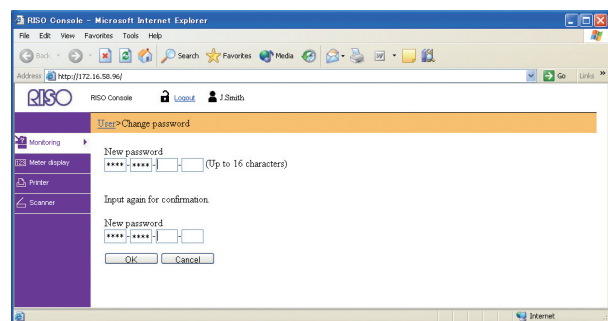

Enter the new password in [New password].

Enter a password of between 0 and 16 alphanumeric characters long. The entered characters are displayed with asterisks (*).

3 Enter the new password again for confirmation.

4 Click [OK].

The message "Settings have been sent." appears.

- To cancel the settings, click [Cancel].
- If an error message appears, enter the password again.

[License Info.] Screen

The [License Info.] screen displays information about the license of the system in the machine.

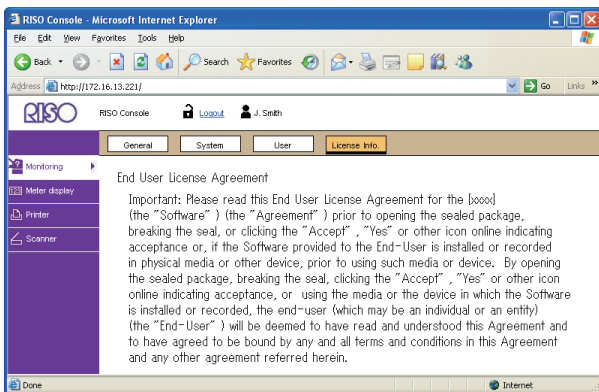

[Meter display] Menu

Click [Meter display] on the side menu to display the number of printouts on this machine.

[Details] Screen

The [Details] screen displays the total number of printouts and copies and the number of printouts by paper size.

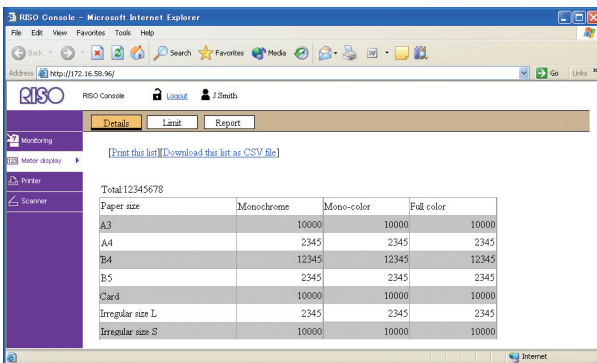

The screenshot shows the RISO Console interface in a Microsoft Internet Explorer browser. The address bar shows 'http://172.16.58.94/'. The left sidebar has 'Monitoring' selected, and 'Meter display' is highlighted. The main content area shows a table with the following data:

Paper size	Monochrome	Mono-color	Full color
A3	10000	10000	10000
A4	2345	2345	2345
B4	12345	12345	12345
B5	2345	2345	2345
Card	10000	10000	10000
Irregular size L	2345	2345	2345
Irregular size S	10000	10000	10000

- [Print this list]
Click this to print the latest information.
- [Download this list as CSV file]
Click this to save the latest information to a computer as a CSV file.



When you click [Print this list] or [Download this list as CSV file], the latest information is obtained and may be different from the information displayed on the screen.

[Limit] Screen

The [Limit] screen (button) is displayed when a quantity limit has been specified for the user logged in.

You can use this screen to check the quantity limit specified by the administrator and the current print/copy count.

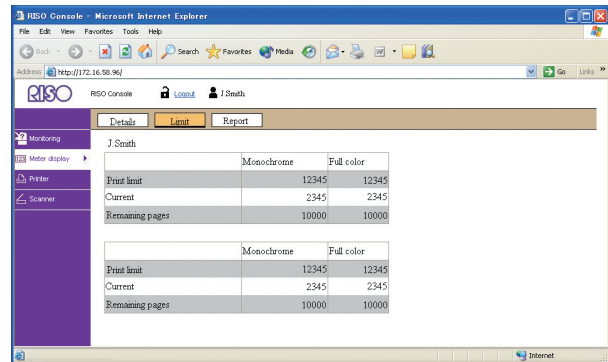

The screenshot shows the RISO Console interface in a Microsoft Internet Explorer browser. The address bar shows 'http://172.16.58.94/'. The left sidebar has 'Monitoring' selected, and 'Meter display' is highlighted. The main content area shows a table with the following data:

	Monochrome	Full color
Print limit	12345	12345
Current	2345	2345
Remaining pages	10000	10000

[Report] Screen

The [Report] screen displays the charge count amounts for monochrome and color jobs.



- [Report] is displayed only when using the ComColor 9050R/7050R/7010R/3050R/3010R.
- For details on the charge counting, contact your dealer (or authorized service representative).

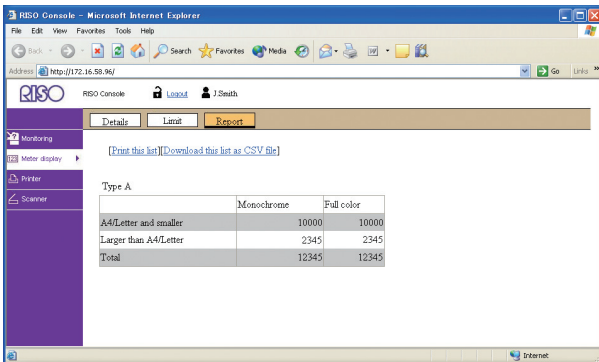

- [Print this list]
Click this to print the latest information.
- [Download this list as CSV file]
Click this to save the total count and details to a computer as a CSV file.





When you click [Print this list] or [Download this list as CSV file], the latest information is obtained and may be different from the information displayed on the screen.



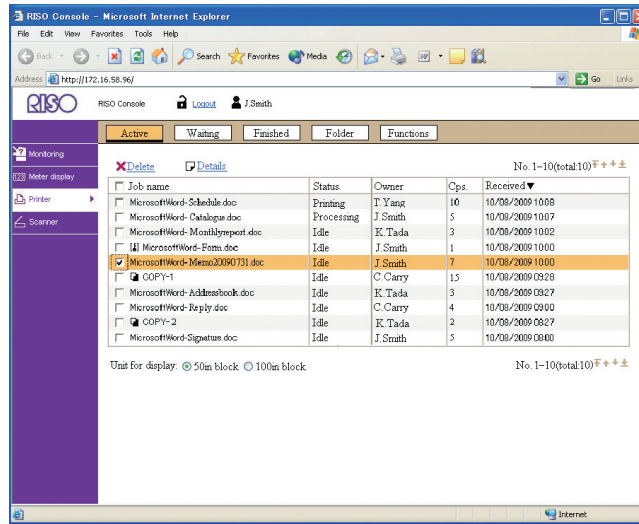

[Printer] Menu

You can click [Printer] on the side menu to display the job list on the RISO Console screen and check the status of jobs. You can also operate the printer and change the settings job.



When an item on the side menu has the  icon, this indicates that you must login before you can access that item. When an item has the  icon, this indicates that access to that mode is restricted.



- Select [50 in block] or [100 in block] to change the number of jobs displayed in the list.
- Click  or  on the right of the screen (at above and under the list) to scroll one page through the list and  or  to jump to the first or last page.
- When the job name exceeds the character limit, the first half of the job name is omitted and the job name is displayed as "...xyz.doc".
- In the following cases, all job names are displayed in the list.
 - When user login is not necessary
 - When the user is logged in with administrative authority
- In the following cases, the job name is displayed as "*****".
 - Jobs with the [Hide job name] check box selected on the printer driver (p. 1-27 "PIN code" in "Printer driver")
 - Jobs with a job name that is closed and requiring login

[Active] Screen

The [Active] screen displays the jobs that are being printed and the jobs that are waiting to be printed automatically.

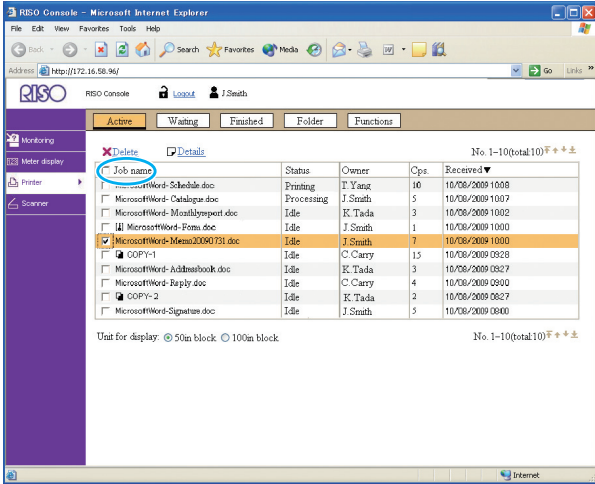

- The job list displays the job name, processing status, owner name, number of copies, and receiving date/time.
- To select a job, click the job name and add a check mark.
- To select all jobs (except jobs with PIN codes), select the [Job name] check box in the title bar (indicated in blue in the above screenshot).
- You can sort jobs by clicking an item in the title bar ([Job name], [Status], [Owner], [Cps.], or [Received]).

- Details
Select a job and click [Details] to display the setting details for that job.

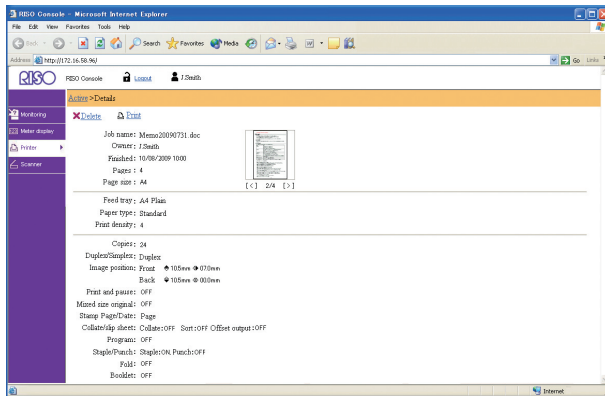

- You can enter job comments using the printer driver setting. (p. 1-10 "Output and Destination" in "Printer driver")

- Delete
Select a job and click [Delete] to delete that job.

[Waiting] Screen

The [Waiting] screen displays waiting jobs.

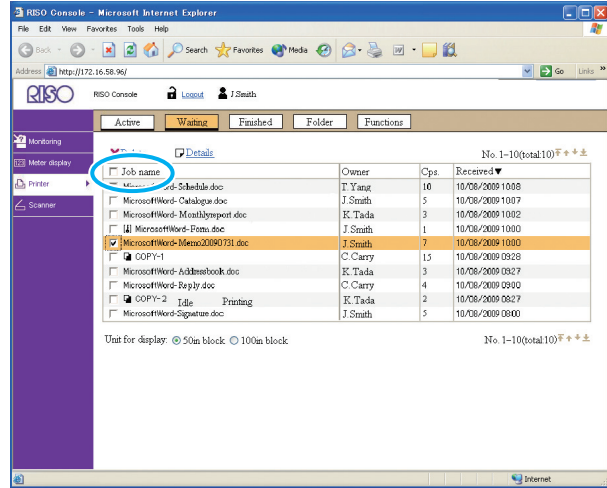

- Warning icon: Waiting jobs cannot be printed from the RISO Console. Use the operation panel of the machine to print these jobs.

- The job list displays the job name, owner name, number of copies, and receiving date/time.
- To select a job, click the job name and add a check mark.
- To select all jobs (except jobs with PIN codes), select the [Job name] check box in the title bar (indicated in blue in the above screenshot).
- The storage period for jobs is configured by the administrator.
- You can sort jobs by clicking an item in the title bar ([Job name], [Status], [Owner], [Cps.], or [Received]).

- Details
Select a job and click [Details] to display the setting details for that job.

- Delete
Select a job and click [Delete] to delete that job.

[Finished] Screen

The [Finished] screen displays the jobs for which printing is finished and jobs with errors.

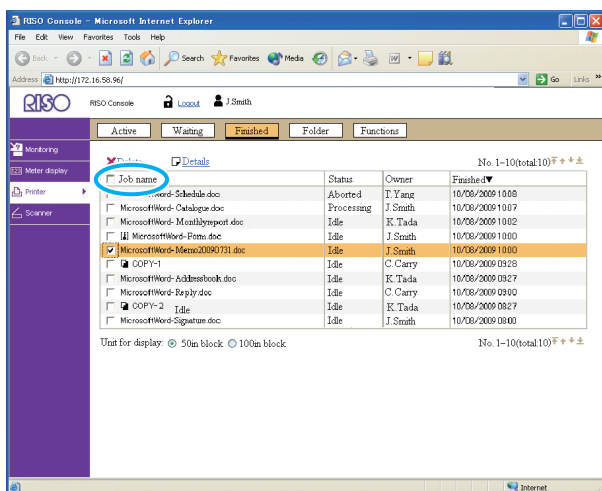

- The job list displays the job name, status, owner name, and finished date/time.
- To select a job, click the job name and add a check mark.
- To select all jobs (except jobs with PIN codes), select the [Job name] check box in the title bar (indicated in blue in the above screenshot).
- The storage period for jobs is configured by the administrator.
- You can sort jobs by clicking an item in the title bar ([Job name], [Status], [Owner], [Cps.], or [Received]).
- Details
Select a job and click [Details] to display the setting details for that job.
- Delete
Select a job and click [Delete] to delete that job.

[Folder] Screen

The [Folder] screen displays the jobs saved to the shared and personal folders. These jobs can be printed or copied to another folder.

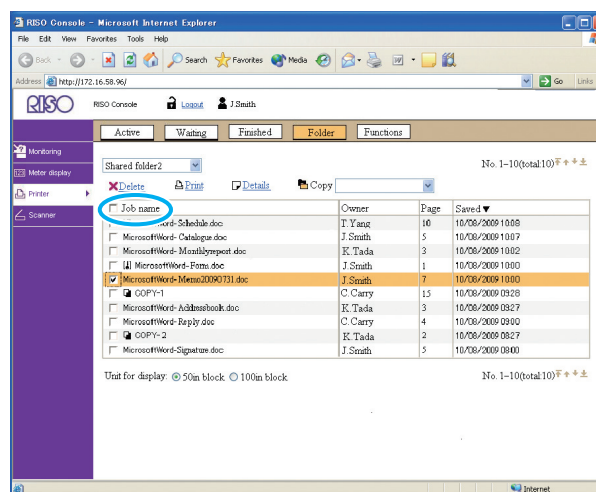

- The folder function may not be available, depending on how the administrator has configured the settings.
- Personal folders are displayed when login is necessary.
- Shared folders are registered by the administrator.
- Jobs are displayed for the folder displayed in the upper left of the list. You can select another folder name to display the jobs inside that folder.
- The job list displays the job name, owner name, number of pages, and saved date/time.
- To select a job, click the job name and add a check mark.
- To select all jobs (except jobs with PIN codes), select the [Job name] check box in the title bar (indicated in blue in the above screenshot).
- You can sort jobs by clicking an item in the title bar ([Job name], [Status], [Owner], [Cps.], or [Received]).
- Print
Select a job and click [Print] to print that job. The job remains on the [Folder] screen after printing.

5 RISO Console

● Details

Select a job and click [Details] to display the setting details for that job.

You can change the following settings.

- Job name
- Feed tray
- Print density
- Copies
- Job comment

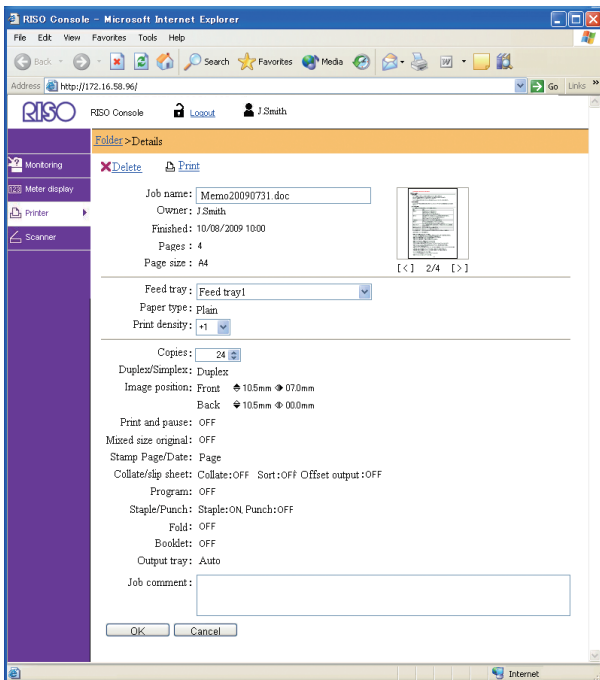

● Delete

Select a job and click [Delete] to delete that job.

● Copy to

To copy a job to another folder, select the job and then select the folder name in the [Copy to] pull-down menu.

[Functions] Screen

Use the [Functions] screen to configure the user-configurable functions of the printer main unit (system).

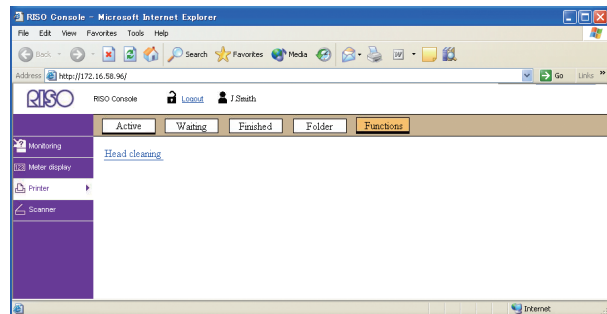

● Head cleaning

Clean the ink head to prevent clogging. Clean the ink head when you notice a change in image quality, such as blurring in part of a printout, white streaking, or faded colors.



When the printer is being used, cleaning of the ink head is performed after the printer has finished printing or copying.



1 Click [Head cleaning], and then click [OK].



When cleaning has been performed normally, the message "Settings have been sent." appears.

- To cancel cleaning, click [Cancel].

[Scanner] Menu

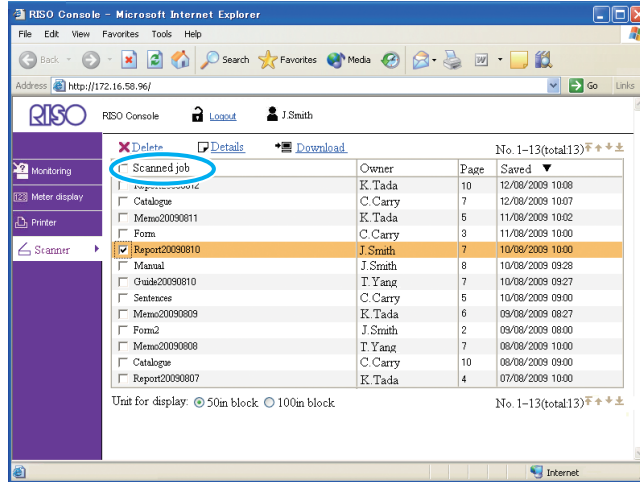
You can click [Scanner] on the side menu to display the scanned job list on the RISO Console screen. You can download scanned data saved on the internal hard disk to a computer.



When an item on the side menu has the  icon, this indicates that you must login before you can access that item. When an item has the  icon, this indicates access to that mode is restricted.

- The job list displays the scanned job name, owner name, number of pages, and saved date/time.
- To select a job, click the job name and add a check mark.
- To select all jobs (except jobs with PIN codes), select the [Scanned job name] check box (indicated in blue in the screen above) in the title bar.
- You can sort jobs by clicking an item in the title bar ([Job name], [Owner], [Cps.], or [Received]).



The storage period for scanned jobs is configured by the administrator with [Scan data save setting]. When that period is reached, the job is deleted automatically.

● Details

Select a job and click [Details] to display the setting details for that job.

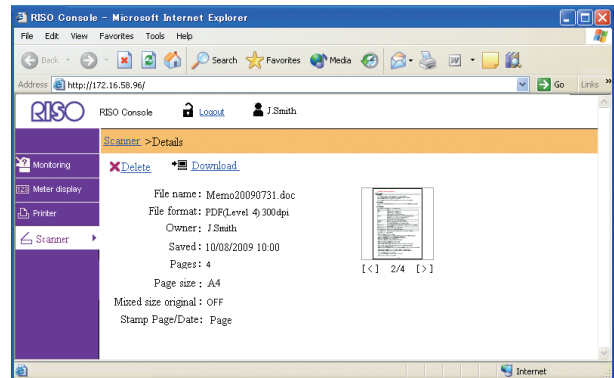

● Delete

Select a job and click [Delete] to delete that job.

● Downloading Scanned Jobs to a Computer

1 Select the check box of the scanned job to download.

- You can select multiple jobs.

2 Click **[Download]**.

The [Download file] dialog box is displayed.

3 Click **[Save]**.

The [Save As] dialog box is displayed.

4 Specify the destination folder and file name, and then click **[Save]**.

The scanned data is saved to the computer.



6

Appendix

Specifications

■ ComColor 9050/9050R Specifications

Basic Functions and Print Functions

Model	SE-H301		
Type	Console		
Color Support	Full color		
Print Type	Line-type inkjet system		
Ink Type	Oil-based pigment ink (Cyan, Magenta, Yellow, Black)		
Resolution	Standard: 300 dpi (main scanning direction) × 300 dpi (sub-scanning direction)		
	Fine: 300 dpi (main scanning direction) × 600 dpi (sub-scanning direction)		
Number of Gray Levels	For each CMYK color (8 gray levels)		
Data Processing Resolution	Standard: 300 dpi × 300 dpi Fine: 300 dpi × 600 dpi Line smoothing: 600 dpi × 600 dpi		
Warm-up Time	2 min. 45 sec. or less (at room temperature of 20°C (68°F))		
First Print Time	Monochrome: 8 sec or less ^{*1} (when copying A4-R/Letter-R orientation using monochrome mode)		
	Color: 8 sec or less ^{*1} (when copying A4-R/Letter-R orientation using color mode)		
Continuous Print Speed ^{*2}	A4-R	Simplex: 150 ppm	Duplex: 75 sheets/minute (150 ppm)
	Letter-R	Simplex: 146 ppm	Duplex: 73 sheets/minute (146 ppm)
	A4	Simplex: 110 ppm	Duplex: 55 sheets/minute (110 ppm)
	Letter	Simplex: 116 ppm	Duplex: 58 sheets/minute (116 ppm)
	B4/Legal	Simplex: 90 ppm	Duplex: 42 sheets/minute (90 ppm)
	A3	Simplex: 80 ppm	Duplex: 40 sheets/minute (80 ppm)
	Ledger	Simplex: 78 ppm	Duplex: 39 sheets/minute (78 ppm)
Duplex Printing	Standard		
Paper Size	Standard Tray	Maximum: 340 mm × 550 mm (13 3/8" × 21 5/8") Minimum: 90 mm × 148 mm (3 9/16" × 5 13/16")	
	Feed Tray	Maximum: 297 mm × 420 mm (11 11/16" × 17") Minimum: 182 mm × 182 mm (7 3/16" × 7 3/16")	
Printable Area	Maximum: 314 mm × 548 mm (12 3/8" × 21 9/16")		
Guaranteed Print Area ^{*3}	Standard: Margin width of 3 mm (1/8") Maximum: Margin width of 1 mm (1/16")		
Paper Weight	Standard Tray	46 g/m ² (12-lb bond) to 210 g/m ² (56-lb bond) (plain paper)	
	Feed Tray	52 g/m ² (14-lb bond) to 104 g/m ² (28-lb bond) (plain paper)	
Paper Feed Method/ Paper Tray Capacity ^{*4}	Standard Tray	1,000 sheets (Height up to 110 mm (4 5/16"))	
	Feed Tray	500 sheets × 3 trays (Height up to 50 mm (1 15/16"))	
Continuous Printing Capacity	9,999 sheets		
Output Tray Capacity ^{*4}	Standard	500 sheets (Height up to 60 mm (2 3/8"))	
	Option	1,000 sheets (when using the optional auto-control stacking tray or wide stacking tray)	

Page Description Language	Original PDL	
Supported Protocols	TCP/IP, HTTP, HTTPs (SSL), DHCP, ftp, lpr, IPP, SNMP, Port 9100 (RAW port)	
Supported Operating Systems	Microsoft® Windows® 2000	
	Microsoft® Windows® XP (32-bit version)	
	Microsoft® Windows Server 2003 (32-bit version)	
	Microsoft® Windows 2000 Server	
	Microsoft® Windows Vista® (32-bit version)	
Installed Fonts	None	
Emulation	None	
Network Interface	Ethernet 1000BASE-T, 100BASE-TX, 10BASE-T (2ch)	
CPU	Intel® Celeron®-M440 (1.86 GHz)	
Memory Capacity	1 GB	
Hard Disk* ⁶	Capacity	160 GB
	Available Space	140 GB
Operating System	Linux	
Power Source	AC 100-240 V, 10-5 A, 50-60 Hz	
Power Consumption	Max. 1,000 W	
	Ready* ⁵ : 250 W	
	Sleep: Max. 45 W	
	Stand-by: Max. 1 W	
Operating Noise	Max. 68 dB (when printing)	
Operating Environment	Temperature: 15°C to 30°C (59°F to 86°F) Humidity: 40% to 70% RH (non-condensing)	
Dimensions (W × D × H)	In use: 1,150 mm × 695 mm × 1,020 mm (45 1/4" × 27 3/8" × 40 3/16")	
Weight	180 kg (397 lb)	
Required Space (W × D × H)	With front cover and feed tray extended: 1,210 mm × 1,230 mm × 1,020 mm (47 5/8" × 48 7/16" × 40 3/16") With face down tray and standard tray stored: 1,150 mm × 695 mm × 990 mm (45 1/4" × 27 3/8" × 39")	

- *1 Within 10 minutes after the last print job
- *2 When using plain paper and recycled paper (85 g/m² (23-lb bond)), and density setting 3 (Standard)
Chart used: Print measurement pattern [Color measurement sample 2 (JEITA standard pattern J6)]
- *3 The margin when printing envelopes is 10 mm (3/8").
The guaranteed area when printing images is the area enclosed within 3 mm (1/8") of the edges of the paper.
- *4 When using plain paper and recycled paper (85 g/m² (23-lb bond))
- *5 When not printing
- *6 One gigabyte (GB) is calculated as 1 billion bytes.

■ ComColor 7050/7050R/3050/3050R Specifications

Basic Functions and Print Functions

Model		ComColor 7050/7050R:SE-M301 ComColor 3050/3050R:SE-M401	
Type		Console	
Color Support		Full color	
Print Type		Line-type inkjet system	
Ink Type		Oil-based pigment ink (Cyan, Magenta, Yellow, Black)	
Resolution		Standard: 300 dpi (main scanning direction) × 300 dpi (sub-scanning direction)	
		Fine: 300 dpi (main scanning direction) × 600 dpi (sub-scanning direction)	
Number of Gray Levels		For each CMYK color (8 gray levels)	
Data Processing Resolution		Standard: 300 dpi × 300 dpi Fine: 300 dpi × 600 dpi Line smoothing: 600 dpi × 600 dpi	
Warm-up Time		2 min. 45 sec. or less (at room temperature of 20°C (68°F))	
First Print Time		Monochrome: 8 sec or less ^{*1} (when copying A4-R/Letter-R orientation using monochrome mode)	
		Color: 8 sec or less ^{*1} (when copying A4-R/Letter-R orientation using color mode)	
Continuous Print Speed ^{*2}	A4-R/Letter-R	Simplex: 120 ppm	Duplex: 60 sheets/minute (120 ppm)
	A4/Letter	Simplex: 90 ppm	Duplex: 45 sheets/minute (90 ppm)
	B4/Legal	Simplex: 76 ppm	Duplex: 38 sheets/minute (76 ppm)
	A3/Ledger	Simplex: 66 ppm	Duplex: 33 sheets/minute (66 ppm)
Duplex Printing		Standard	
Paper Size	Standard Tray	Maximum: 340 mm × 550 mm (13 3/8" × 21 5/8") Minimum: 90 mm × 148 mm (3 9/16" × 5 13/16")	
	Feed Tray	Maximum: 297 mm × 420 mm (11 11/16" × 17") Minimum: 182 mm × 182 mm (7 3/16" × 7 3/16")	
Printable Area		ComColor 7050/7050R: Maximum: 314 mm × 548 mm (12 3/8" × 21 9/16") ComColor 3050/3050R: Maximum: 210 mm × 544 mm (8 1/4" × 21 7/16")	
Guaranteed Print Area ^{*3}		ComColor 7050/7050R: Standard: Margin width of 3 mm (1/8") Maximum: Margin width of 1 mm (1/16") ComColor 3050/3050R: Standard: Margin width of 5 mm (3/16") Maximum: Margin width of 3 mm (1/8")	
Paper Weight	Standard Tray	46 g/m ² (12-lb bond) to 210 g/m ² (56-lb bond) (plain paper)	
	Feed Tray	52 g/m ² (14-lb bond) to 104 g/m ² (28-lb bond) (plain paper)	
Paper Feed Method/ Paper Tray Capacity ^{*4}	Standard Tray	1,000 sheets (Height up to 110 mm (4 5/16"))	
	Feed Tray	500 sheets × 3 trays (Height up to 50 mm (1 15/16"))	
Continuous Printing Capacity		9,999 sheets	
Output Tray Capacity ^{*4}	Standard	500 sheets (Height up to 60 mm (2 3/8"))	
	Option	1,000 sheets (when using the optional auto-control stacking tray or wide stacking tray)	
Page Description Language		Original PDL	
Supported Protocols		TCP/IP, HTTP, HTTPS (SSL), DHCP, ftp, lpr, IPP, SNMP, Port 9100 (RAW port)	

Supported Operating Systems	Microsoft® Windows® 2000	
	Microsoft® Windows® XP (32-bit version)	
	Microsoft® Windows Server 2003 (32-bit version)	
	Microsoft® Windows 2000 Server	
	Microsoft® Windows Vista® (32-bit version)	
Installed Fonts	None	
Emulation	None	
Network Interface	Ethernet 1000BASE-T, 100BASE-TX, 10BASE-T (2ch)	
CPU	Intel® Celeron®-M440 (1.86 GHz)	
Memory Capacity	512 MB	
Hard Disk* ⁶	Capacity	160 GB
	Available Space	140 GB
Operating System	Linux	
Power Source	AC 100-240 V, 10-5 A, 50-60 Hz	
Power Consumption	Max. 1,000 W	
	Ready* ⁵ : 250 W	
	Sleep: Max. 45 W	
	Stand-by: Max. 1 W	
Operating Noise	Max. 68 dB (when printing)	
Operating Environment	Temperature: 15°C to 30°C (59°F to 86°F) Humidity: 40% to 70% RH (non-condensing)	
Dimensions (W × D × H)	In use: 1,150 mm × 695 mm × 1,020 mm (45 1/4" × 27 3/8" × 40 3/16")	
Weight	180 kg (397 lb)	
Required Space (W × D × H)	With front cover and feed tray extended: 1,210 mm × 1,230 mm × 1,020 mm (47 5/8" × 48 7/16" × 40 3/16") With face down tray and standard tray stored: 1,150 mm × 695 mm × 990 mm (45 1/4" × 27 3/8" × 39")	

*1 Within 10 minutes after the last print job

*2 When using plain paper and recycled paper (85 g/m² (23-lb bond)), and density setting 3 (Standard)
Chart used: Print measurement pattern [Color measurement sample 2 (JEITA standard pattern J6)]

*3 The margin when printing envelopes is 10 mm (3/8").

For ComColor 7050/7050R, the guaranteed area when printing images is the area enclosed within 3 mm (1/8") of the edges of the paper.

For ComColor 3050/3050R, the guaranteed area when printing images is the area enclosed within 5 mm (3/16") of the edges of the paper.

*4 When using plain paper and recycled paper (85 g/m² (23-lb bond))

*5 When not printing

*6 One gigabyte (GB) is calculated as 1 billion bytes.

■ ComColor 7010/7010R/3010/3010R Specifications

Basic Functions and Print Functions

Model	ComColor 7010/7010R:SE-L301 ComColor 3010/3010R:SE-L401		
Type	Console		
Color Support	Full color		
Print Type	Line-type inkjet system		
Ink Type	Oil-based pigment ink (Cyan, Magenta, Yellow, Black)		
Resolution	Standard: 300 dpi (main scanning direction) × 300 dpi (sub-scanning direction)		
	Fine: 300 dpi (main scanning direction) × 600 dpi (sub-scanning direction)		
Number of Gray Levels	For each CMYK color (8 gray levels)		
Data Processing Resolution	Standard: 300 dpi × 300 dpi Fine: 300 dpi × 600 dpi Line smoothing: 600 dpi × 600 dpi		
Warm-up Time	2 min. 45 sec. or less (at room temperature of 20°C (68°F))		
First Print Time	Monochrome: 8 sec or less ^{*1} (when copying A4-R/Letter-R orientation using monochrome mode)		
	Color: 8 sec or less ^{*1} (when copying A4-R/Letter-R orientation using color mode)		
Continuous Print Speed ^{*2}	A4-R/Letter-R	Simplex: 120 ppm	Duplex: 60 sheets/minute (120 ppm)
	A4/Letter	Simplex: 90 ppm	Duplex: 45 sheets/minute (90 ppm)
	B4/Legal	Simplex: 76 ppm	Duplex: 38 sheets/minute (76 ppm)
	A3/Ledger	Simplex: 66 ppm	Duplex: 33 sheets/minute (66 ppm)
Duplex Printing	Standard		
Paper Size	Maximum: 340 mm × 550 mm (13 3/8" × 21 5/8") Minimum: 90 mm × 148 mm (3 9/16" × 5 13/16")		
Printable Area	ComColor 7010/7010R Maximum: 310 mm × 544 mm (12 3/16" × 21 7/16") ComColor 3010/3010R Maximum: 210 mm × 544 mm (8 1/4" × 21 7/16")		
Guaranteed Print Area ^{*3}	Standard: Margin width of 5 mm (3/16") Maximum: Margin width of 3 mm (1/8")		
Paper Weight	46 g/m ² (12-lb bond) to 210 g/m ² (56-lb bond) (plain paper)		
Paper Feed Method/Paper Tray Capacity ^{*4}	1,000 sheets (Height up to 110 mm (4 5/16"))		
Continuous Printing Capacity	9,999 sheets		
Output Tray Capacity ^{*4}	Standard	500 sheets (Height up to 60 mm (2 3/8"))	
	Option	1,000 sheets (when using the optional auto-control stacking tray or wide stacking tray)	
Page Description Language	Original PDL		
Supported Protocols	TCP/IP, HTTP, HTTPs (SSL), DHCP, ftp, lpr, IPP, SNMP, Port 9100 (RAW port)		
Supported Operating Systems	Microsoft® Windows® 2000		
	Microsoft® Windows® XP (32-bit version)		
	Microsoft® Windows Server 2003 (32-bit version)		
	Microsoft® Windows 2000 Server		
	Microsoft® Windows Vista® (32-bit version)		
Installed Fonts	None		
Emulation	None		

Network Interface		Ethernet 1000BASE-T, 100BASE-TX, 10BASE-T (2ch)
CPU		Intel® Celeron®-M440 (1.86 GHz)
Memory Capacity		512 MB
Hard Disk* ⁶	Capacity	160 GB
	Available Space	140 GB
Operating System		Linux
Power Source		AC 100-240 V, 10-5 A, 50-60 Hz
Power Consumption		Max. 1,000 W
		Ready* ⁵ : 250 W
		Sleep: Max. 45 W
		Stand-by: Max. 1 W
Operating Noise		Max. 68 dB (when printing)
Operating Environment		Temperature: 15°C to 30°C (59°F to 86°F) Humidity: 40% to 70% RH (non-condensing)
Dimensions (W × D × H)		In use: 1,150 mm × 695 mm × 1,020 mm (45 1/4" × 27 3/8" × 40 3/16")
Weight		160 kg (353 lb)
Required Space (W × D × H)		With front cover extended: 1,210 mm × 1,230 mm × 1,020 mm (47 5/8" × 48 7/16" × 40 3/16") With face down tray and standard tray stored: 1,150 mm × 695 mm × 990 mm (45 1/4" × 27 3/8" × 39")

*1 Within 10 minutes after the last print job

*2 When using plain paper and recycled paper (85 g/m² (23-lb bond)), and density setting 3 (Standard)
Chart used: Print measurement pattern [Color measurement sample 2 (JEITA standard pattern J6)]

*3 The margin when printing envelopes is 10 mm (3/8").

The guaranteed area when printing images is the area enclosed within 5 mm (3/16") of the edges of the paper.

*4 When using plain paper and recycled paper (85 g/m² (23-lb bond))

*5 When not printing

*6 One gigabyte (GB) is calculated as 1 billion bytes.

■ Scanner HS4000 (Optional)

Copy/Scan Functions

Type	Flat Bed Scanner with Automatic Document Feeder (ADF)	
Scanning modes	Color, Monochrome, Auto	
Scanning resolution	600 dpi, 400 dpi, 300 dpi, or 200 dpi	
Maximum scanning area	303 mm × 432 mm (11 15/16" × 17") (when using platen glass) 297 mm × 432 mm (11 11/16" × 17") (when using ADF)	
Copy functions	Writing resolution	Standard: 300 dpi × 300 dpi Fine: 300 dpi × 600 dpi
	Copy paper size	Maximum: 303 mm × 432 mm (11 15/16" × 17") (equivalent to A3)
	Initial copy time	Monochrome/Color: 11.5 sec or less (when copying A4-R/Letter-R orientation using Color Priority Mode)
	Scanning speed	Simplex copying (A4-R/Letter-R, using ADF): 40 ppm or higher Duplex copying (A4-R/Letter-R, using ADF): 9 sheets/minute (18 ppm) or higher
	Reproduction size	50% to 200% (Copy mode) 50% to 200% (Scanner mode, resolution: 200/300 dpi), only 100% (Scanner mode, resolution: 400/600 dpi)
ADF	Type	Original source displacement (capable of duplex scanning by switch-back)
	Original source size	Maximum: 297 mm × 432 mm (11 11/16" × 17") (equivalent to A3) Minimum: 100 mm × 148 mm (3 15/16" × 5 13/16")
	Paper quality	52 g/m ² (14-lb bond) to 128 g/m ² (34-lb bond)
	Original source capacity Smaller than B4 size	80 g/m ² (21-lb bond): Max. 100 sheets 81 g/m ² (22-lb bond): Height up to 15 mm (5/8")
	Original source capacity B4 size or larger	80 g/m ² (21-lb bond): Max. 60 sheets 81 g/m ² (22-lb bond): Height up to 9 mm (3/8")
	Original source exchange speed	Simplex printing: 40 ppm or higher (A4-R/Letter-R) Duplex printing: 9 sheets/minute (18 ppm) or higher (A4-R/Letter-R)
Scan functions	Scanning gray levels	10-bit input and 8-bit output for each RGB color
	Original source scanning speed	Monochrome/Color: 40 ppm * RISO KAGAKU standard original (A4-R/Letter-R), 200 dpi, when stored to main unit hard drive
	Network Interface*	Ethernet 1000BASE-T/100BASE-TX/10BASE-T
	Data-saving method*	Save to main unit hard drive, server, or USB flash drive, or send by e-mail
	Data-saving format*	Monochrome: TIFF, PDF Grayscale/Full Color: TIFF, JPEG, PDF
Power source	AC 100-127/200-240 V, 50/60 Hz	
Power consumption	Max. 120 W	
Dimensions	642 mm × 551 mm × 248 mm (25 1/4" × 21 11/16" × 9 3/4")	
Weight	Approx. 28 kg (62 lb)	
Dimensions (when connected to main unit) (W × D × H)	In use: 1,220 mm × 800 mm × 1,220 mm (48" × 31 1/2" × 48") With cover and tray extended: 1,220 mm × 1,335 mm × 1,610 mm (48" × 52 9/16" × 63 3/8")	

* Via the internal host controller

■ Multifunction Finisher (Optional)

Tray Type	Top Tray	Collating, stacking
	Stacking Tray	Collating, stacking (offset)
	Booklet Tray	Booklet, Paper folding
Paper Size	Top Tray ^{*1}	Maximum: 330 mm × 488 mm (13" × 19 3/16") Minimum: 100 mm × 148 mm (3 15/16" × 5 13/16")
	Stacking Tray ^{*1}	Maximum: 330 mm × 488 mm (13" × 19 3/16") Minimum: 182 mm × 182 mm (7 3/16" × 7 3/16")
	Stapling	Maximum: 297 mm × 432 mm (11 11/16" × 17") (equivalent to A3) Minimum: 203 mm × 182 mm (8" × 7 3/16")
	Booklet Tray ^{*1}	Maximum: 330 mm × 457 mm (13" × 18") Minimum: 210 mm × 280 mm (8 1/4" × 11")
Paper Weight	Top Tray	52 g/m ² (14-lb bond) to 210 g/m ² (56-lb bond)
	Stacking Tray	52 g/m ² (14-lb bond) to 210 g/m ² (56-lb bond)
	Booklet Tray	60 g/m ² (16-lb bond) to 90 g/m ² (24-lb bond) (cover: 210 g/m ² (56-lb bond))
Tray Capacity	Top Tray	500 sheets
	Stacking Tray ^{*3}	2,000 sheets (200 copies)
	Booklet Tray	20 copies
Stapling	Maximum Number of Staples ^{*2*4}	100 sheets
	Staple Paper Size	Maximum: 297 mm × 432 mm (11 11/16" × 17") (equivalent to A3) Minimum: 203 mm × 182 mm (8" × 7 3/16") (equivalent to B5-R)
	Staple Position	1 at front side (angle stapling), 1 at rear side (angle stapling ^{*5} , parallel stapling), 2 at center (parallel stapling)
Punching	Number of Punches	2 holes, 3 holes 2 holes, 4 holes
	Applicable Sizes	2 holes: A3, B4, A4-R, A4, B5-R, Ledger, Legal, Letter, Letter-R 3 holes: A3, B4, A4-R, B5-R, Ledger, Letter-R 4 holes: A3, A4-R, Ledger, Letter-R
	Paper Weight	52 g/m ² (14-lb bond) to 200 g/m ² (53-lb bond)
Creating a Booklet (Center margin/2-fold)	Maximum Number of Sheets ^{*2*6}	Center margin: 15 sheets (60 pages) 2-fold: 5 sheets (20 pages)
Operating Environment		Temperature: 15°C to 35°C (59°F to 95°F) Humidity: 40% to 70% RH (non-condensing)
Dimensions (W × D × H)		1,100 mm × 760 mm × 1,165 mm (43 5/16" × 29 15/16" × 45 7/8")
Weight		131 kg (289 lbs)
Power Source		AC 100-120/200-240 V, 50/60 Hz, 2.0/1.0 A or more
Power Consumption		Max. 175 W
Operating Noise (when using finisher)		Max. 68 dB
Dimensions (when Connected to main unit) (W × D × H)		In use: 2,295 mm × 760 mm × 1,165 mm (90 3/16" × 29 15/16" × 45 7/8")
		With cover, and tray extended: 2,295 mm × 1,275 mm × 1,165 mm (90 3/8" × 50 3/16" × 45 7/8")

*1 When color printing on paper that is longer than 432 mm (17"), the image printed beyond 432 mm (17") may be distorted.

*2 When using plain paper and recycled paper (85 g/m² (23-lb bond))

*3 When using plain paper and recycled paper (85 g/m² (23-lb bond)) with A4 or B5-R orientation
When using paper sizes other than A4 or B5-R, the capacity is 1,500 sheets (100 copies)

*4 65 sheets for a paper size exceeding A4/Letter

*5 Rear-side angle stapling is only available for A4-R and A3.

*6 Includes an added cover.

■ IC Card Authentication Kit (Optional)

Applicable Card	ISO 14443 TypeA/TypeC (FeliCa [®] /Mifare [®])
Radio Law Category	Guided read-write communication equipment
Power Source	Power received from USB port
Operating Environment	Temperature: 15°C to 30°C (59°F to 86°F) Humidity: 40% to 70% RH (non-condensing)
Dimensions (W × D × H)	92 mm × 64 mm × 16 mm (3 5/8" × 2 1/2" × 5/8") (excluding protruding parts)
Weight	90 g (3 oz)

Consumables

It is recommended that you use consumables manufactured by RISO KAGAKU CORPORATION.
Consumable specifications and types are subject to change without notice.
For pricing information, contact your dealer (or authorized service representative).

Ink Cartridges

Type	Color	Quantity	Unit
ComColor Ink Cartridge 1000	Cyan Magenta Yellow Black	NET. 1,000 ml	1 piece
ComColor Ink Cartridge 500	Cyan Magenta Yellow Black	NET. 500 ml	
ComColor Ink Cartridge R	Cyan Magenta Yellow Black	NET. 1,000 ml	

Index

A

About tab	1-27
Active screen	4-6, 5-10
Add cover	1-18, 2-40
Additional copies	2-24
Advanced tab	1-23
Attach data to an e-mail message	3-6
Auto reduce	1-19, 2-48
Automatic document feeder (ADF)	8
Auto-Rotate	2-43

B

Backlight OFF	23
Base color level	2-35
Basic tab	1-7
Between jobs	1-17, 2-42
Between sets	1-17, 2-42
Binding margin	1-20, 2-45
Binding side	1-20, 2-44, 2-47
Black	1-7, 2-8, 3-11
Blank Paper Cut Down	1-24
Book shadow erase	2-29
Booklet	2-47
Booklet binding	1-18
Booklet cover	1-19
Booklet tray	9

C

Card-IJ	1-10
Center margin	1-19
Changing settings	
during copying	2-5
during printing	4-6
Check setting	2-18
Chroma	1-15
Clear key	10
Collate	1-17, 2-41
Color	3-11
Color mode	1-7, 2-8, 3-11
Color profile	1-10
Consumables	6-11
Continuous output	1-25
Contrast	1-15
Copies	1-23
Copy and pause	2-23
Copy mode screen	11
Copy, canceling	2-5
Counter key	10
Custom paper entry	1-29
Cyan	1-7

D

Data compression	3-9
Data receive lamp	10
Details screen	5-7
D-Feed Check	2-11
Direct Access entry	2-17
Dot process	1-16
Duplex copying	2-14
Duplex printing	1-7
Duplex/Simplex	2-14, 3-12

E

Eject button	9
Envelopes, loading	25
Environment tab	1-28
Error diffusion	1-16
Error lamp	10

F

Face down tray	7
Feed ctrl.	2-11
Feed tray	8, 2-9, 4-14
changing settings	2-10
selecting	2-9
File format	3-9
Finished job, changing settings	4-11
Finished screen	4-8, 5-11
Finisher	9
Finishing tab	1-17
Fold direction	1-22
Folder job, changing settings	4-11
Folder screen	5-11
FORCEJET link icon	11
Format for PC	3-4
Front cover	7
Front doors release	2-52
Full color	1-7, 2-8
Function keys	10
Functions screen	5-12

G

Gamma control	1-15, 2-34
General screen	12, 5-4
Grayscale	3-11
Group	2-41

H

Halftone	1-16
HDD usage	4-3
Head cleaning	2-51, 5-12
High-quality	1-10

I

Icons, job	4-3
IJ paper	1-10
Image control	2-35
Image position	1-14
Image quality	1-16, 2-33
Image size	3-10
Image tab	1-15
Imposition	1-12
Index buttons	14
Ink cartridges	6-11
Input tray	1-9
Interrupt copy	2-52
Interrupt key	10
Interrupt lamp	10

J

Job list	4-3
Jobs stored in folders, printing	4-10
Jobs, saving	3-7
Jump wing control	2-51

L

Layout tab	1-12
Left cover	9
License Info. screen	12, 5-6
Lightness	1-15
Limit screen	5-7
Line smoothing	1-15
Loading the next copy job	2-5
Locking lever	23
Login	11, 13, 5-3
Login password, changing	14, 5-5
Long edge	1-7

M

Magenta	1-7
Main power lamp	10
Main power switch	8
Main unit	7
Main unit socket	8
Matt coated	1-10
Message area	4-3
Mixed original size	2-28
Mixed size	1-8
Mode buttons	11
MODE key	10
Mode screen	11

Multi-up	2-30
Multi-up (Plural)	1-13, 2-30
Multi-up (Single)	1-13, 2-31

N

Normal cleaning	2-51
Numeric keys	10

O

Offset output	1-18
Online	4-14
Operation panel	7, 10
Original	2-12, 3-13
Original cover	8
Original guide	8
Original image	1-15
Original orientation	1-8, 2-44, 2-45, 3-12
Original output tray	8
Original size	
about	1-8
custom	1-8
Original unit lever	8
Output tray	1-23, 2-49
Output tray relay	2-49

P

Page size	
about	1-9, 2-10
Paging direction	3-12
Paper arranger	8, 27
Paper feed guide lever	7
Paper feed pressure adjustment lever	7
Paper folding	1-22, 2-45, 2-46
Paper guide (end)	8
Paper guide (side)	8
Paper guide control	2-50
Paper guides open button	8
Paper size	
custom	1-9
Paper type	1-10, 2-11
Paper, loading	23
PIN code	1-27, 3-15
Platen glass	8
Power-saving features	23
Print and pause	1-23
Print density	1-16, 4-13
Printable in this machine (save to external CI)	3-4
Printable in this machine (save to folder)	3-4
Printer driver screen	1-2
Printer mode screen	11
Printer status button	11
Program	1-24, 2-36
Punch	1-22, 2-43

R

Register folder	1-30
Remaining ink indicator	11
Report screen	5-8
Reproduction size	2-9
RESET key	10
Resolution	3-9
Right cover	9
RISO auto-control stacking tray	8
RISO Console, starting	5-3
Rotate	1-14

S

Save	
to a computer on the Network	3-6
to a USB flash drive	3-5
to the internal hard disk	3-5
Save to archive	2-26
Save to folder	1-10, 2-24
Save/Call setting	2-19
Scan, canceling	3-7
Scanner	8
Scanner lamp	8
Scanner mode screen	12
Scanner power switch	8
Scanner socket	8
Scanning level	2-13, 3-12
Scanning size	2-27
Screening	1-16
Select layout	2-22
Selections entry	2-17
Separate books	1-19, 2-47
Short edge	1-7
Sleep status	23
Slip sheet	1-17, 2-41
Sort	2-41
Stacking tray	
about	8, 9
closing	28
preparing	27
Stamp Page/Date	1-26, 2-31
Standard tray	
about	7
adding paper	26
closing	26
switching paper	26
Standard tray descent button	8
Standard tray paper guide	7
Staple	1-21, 2-43
START key	10
Start lamp	10
Status	11
Status bar	4-3
Status Save/Call	1-11
Status screen	12
STOP key	10
Stopper	23
Strong cleaning	2-51

Sub power key	10
System screen	12, 5-5

T

Tab	1-2
Text, entering	15
Top side left	2-14, 3-12
Top side up	2-14, 3-12
Top tray	9
Touch panel	10, 13
Tray selection	2-12
Two-sided original, simplex copying	2-15

U

USB port	8
User screen	12, 5-5

W

Waiting screen	4-7, 5-10
Wake up key	10
Watermark	1-25
Wide stacking tray	8

Z

Zoom	1-9
------------	-----



RISO

Please contact following for supplies and service: