

---

---

---

# ComColorExpress IS700C

---

---

---

## *Utility Guide*



 **CAUTION**

To ensure safety precautions, be sure to read the Setup Guide (separate manual) before using the product.

After reading this manual, keep it in handy for future reference.

# Preface

Thank you for purchasing the ComColorExpress IS700C.

This product is a print controller for using RISO high-speed colour printers as network compatible PostScript®3™ printers. This unit allows various functions such as data output and printer monitoring to be used from Windows and Macintosh computers.

## Organization of Instruction Manuals

---

There are three instruction manuals for this product.

- “ComColorExpress IS700C Setup Guide”  
This manual describes how to connect the IS700C and the installation procedures for the software that comes with this product.
- “ComColorExpress IS700C Printer Driver Guide”  
This manual describes specific functions of and the setup procedure for the printer driver.
- “ComColorExpress IS700C Utility Guide” (This Manual)  
This manual describes Console functions for checking the status of and managing this product through a network, software that comes with this product, and operation procedures for the optional Touch Panel Display and scanning functions.

Read each of the manuals before using this product or when there is something you do not understand while using it.

## Content of Instruction Manuals

---

### Notes

- 1) Unauthorised reproduction of all or part of this manual is strictly prohibited.
- 2) Since there may be improvements to the product, the content of this manual may change in the future without notice.
- 3) RISO takes no responsibility for effects resulting from this manual or the operation of this product.

## Copyrights

---

Adobe®, Adobe PS®, PostScript®, PostScript®3™, PostScript logo, AppleTalk®, Macintosh® and Mac OS® are registered trademarks of Apple, Inc. in the United States and other countries.

Microsoft® and Windows® are registered trademarks of Microsoft Corporation, USA in the United States and other countries.

Other product names and company names mentioned in this manual are trademarks or registered trademarks of various companies.

Copyright © 2007 RISO KAGAKU CORPORATION

# Contents

Icons Used in This Manual .....	5
Terminology used in this manual .....	5
<b>RISO Console .....</b>	<b>6</b>
Displaying the RISO Console Screen.....	6
Overview of the RISO Console Screen .....	7
Logging in to the Print Controller .....	8
How to Log In .....	8
Selecting Languages .....	8
Functions for Guest Users / General Users.....	9
Queue.....	10
Checking Queue Settings.....	10
Adding a Job to the Queue.....	12
Queue management.....	13
Jobs (Job manager).....	14
Checking Job Status.....	14
Printing a Job.....	15
Copying a Job to Another Queue .....	15
Moving a Job to Another Queue .....	16
Deleting a Job.....	16
Cancelling a Processing / Waiting Job .....	17
Rearranging Job Display Order .....	17
Displaying Thumbnails of a Job (Job Preview).....	18
Viewing / Editing Job Details .....	19
Using RIP Data (Archived jobs).....	31
Creating Archived Jobs .....	31
Printing Archived Jobs .....	31
Editing Archived Jobs .....	32
Downloading Archived Jobs to the Computer .....	36
Merging Multiple Archived Jobs.....	38
Merging Pages from Multiple Archived Jobs .....	39
Importing a Archived Job from the Computer.....	40
Checking Printer Status.....	41
General.....	41
Paper trays .....	41
Output trays .....	42
Installable options.....	42
Consumables.....	43

---

## Administrator Settings 44

---

Administrator .....	44
How to Log In .....	44
Available functions for administrator.....	44
Detailed Settings of the Print Controller .....	45
General.....	46
Network settings .....	47
User management .....	48
Job settings .....	50
Event log.....	52
RIPs in network .....	54
Time settings .....	55
Touch panel settings .....	56
Backup.....	58
Customization Settings.....	60
Custom forms .....	60
Custom paper sizes.....	61
PCL tray setting.....	62
Colour Calibration.....	63
Profile management .....	64
Uploading profiles [Upload profile].....	64
Checking Account Information.....	66
Checking the System Events Log.....	68
Managing Custom Queue.....	69
Creating New Queues [Create new queue].....	69
Deleting Custom Queues [Delete queue].....	70
Changing Detailed Settings of Queues [Queue details...] .....	71
Stopping Queue Processing [Stop] .....	74
Resuming Queue Processing [Start] .....	74
Rebooting the Print Controller .....	75
Shutting Down the Print Controller .....	75

---

## **Using the Included Utility Software 76**

---

Utility Software.....	76
Using the RISO Management Tool.....	77
Starting the RISO Management Tool .....	77
Basic screen .....	77
Searching for Print Controllers on the Network .....	78
Displaying Print Controller Settings .....	78
Adding Print Controllers to the List.....	79
Deleting Print Controllers from the List.....	79
Starting Up Print Controllers .....	80
Displaying Latest Status .....	80
Starting Up the RISO Console.....	81
Using SMAP .....	82
Starting SMAP .....	82
Direct Printing by SMAP .....	83
Dragging and Dropping Files on the SMAP Icon on the Desktop.....	84

---

## **Using the Touch Panel Display (Option) 86**

---

Touch Panel Screen.....	86
Calibrating the Touch Panel Display .....	87
Selecting Languages .....	88
Logging In from the Touch Panel Display.....	89
Job Manager screen.....	93
Printer Screen.....	94
Controller Screen.....	94
How to Use Copy Functions .....	95
Copy .....	96
Scan settings .....	97
Image processing .....	98
Gamma.....	99
Management of Copy Jobs.....	100
How to Use Scan Functions .....	101
Scan .....	102
Scan settings .....	103
Image processing .....	104
Gamma.....	105
Scan Destination .....	106
Management of Scanned Jobs.....	107
Rebooting / Shutting Down the Print Controller.....	108

---

## **Appendix 110**



---

Troubleshooting.....	110
Error screen of the Touch Panel Display (Option).....	111
Index.....	112

---

# Icons Used in This Manual

Functions, operations and cautions are described as follows in this manual.

<b>Important!</b>	describes items where care is necessary or where there are prohibitions.
<b>Note</b>	describes items where there is particularly helpful information and ones where there is something that should be known.
	indicates the title and page of an item that should be referred to and thoroughly understood. When the reference is to another manual, the name of the manual will also be noted.
 <b>WARNING</b>  <b>Caution</b>	are safety cautions. "Safety Precautions" are described in a separate manual, "ComColorExpress IS700C Setup Guide". Be sure to read them before using this product.

## Terminology used in this manual

---

### ◆ Job

The original data sent from the computer is not directly sent to the printer but temporarily stored in the print controller. The data in this status is called a "job".

### ◆ Queue

The jobs stored in the print controller are lined up in a "window" for executing print processing. Various settings on how to process the sent jobs can be registered in this "window" in advance. This "window" is called a "queue".

### ◆ Login

In order to access networks and specific device, a login ID and password are required. The act of inputting such information in order to access network and device is called "login".

# RISO Console

The RISO Console is a utility software that draws out the full capabilities of the ComColorExpress IS700C.

Accessing the IS700C from your web browser enables you, among other things, to utilize the job manager for output data, and to monitor the printer.

The software makes available a variety of convenient functions, including the **[Create new queue]** function that reduces the time taken to set printing conditions, and the **[Hold queue]** function that enables quick printing by simply calling up data uploaded in advance.

The basic functions (the functions that guest users / general users can use) and the operation method of the RISO Console are explained here.

For details on the functions for the administrator, see “Administrator Setting”. [p.44](#)

For user authority (guest user / general user / administrator), see “Logging in to the Print Controller”. [p.8](#)

## Displaying the RISO Console Screen

**1 Launch your Web browser.**  
See your computer operating manual or Help.

**2 Input the IP address in the address bar of the URL.**  
In the address bar, enter `http://the IP address of the printer controller.`  
The administrator sets the IP address. Enter the IP address (i.e. 192.168.9.51) confirmed by the administrator.

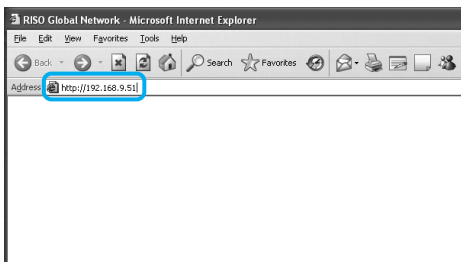

**3 Press the [ENTER] key.**  
The screen of the RISO console is displayed.

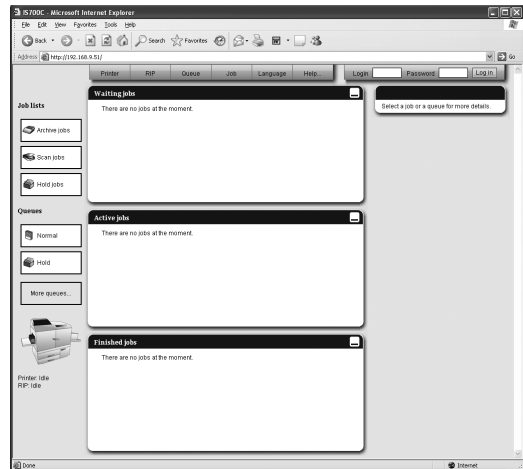

### Note:

- We recommend creating a desktop shortcut as an easy way of displaying the RISO Console screen.
- When accessing to the print controller by https (encrypted communication), enter `https://(the IP address of the printer)` in the address bar. It is also possible to access the print controller automatically by https (encrypted communication). [p.47](#)
- The RISO Console screen can be also displayed from **[WWW]** on the RISO Management Tool. [p.81](#)



# Overview of the RISO Console Screen

The screen layout of the RISO Console is explained below.

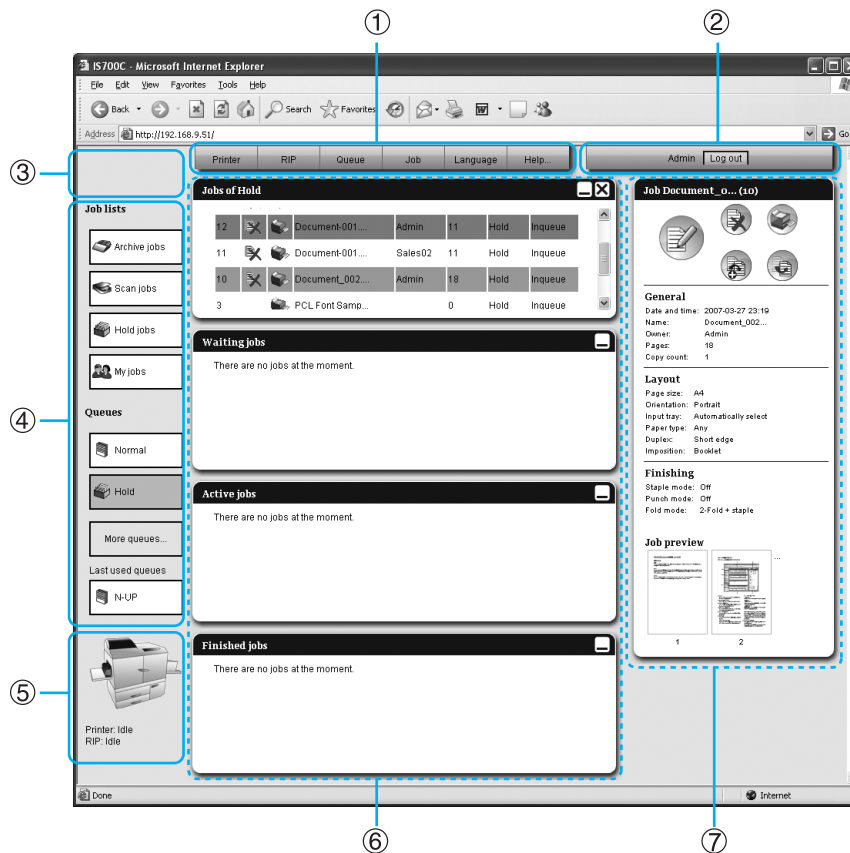

## 1) Menu

Displays submenu by moving the mouse pointer over each menu button.

## 2) Login information input area

Logs in by entering the login ID and the password.

## 3) Message display area

Displays confirmation messages and error messages related to the operation on the Console screen.

## 4) Job / Queue selection button

Clicking the Queue or Job button switches to the job list of the selected queue or job type.

### Note:

- Clicking the **[Scan jobs]** button displays the job list of the image scanned in the scan mode.
- Clicking the **[My jobs]** button after logging in displays only your own jobs.

## 5) Status display area



Displays the current status of the printer and the print controller.

## 6) Job list

The jobs in the print controller are listed according to the processing status.

- Jobs in the queue**  
Displays a list of jobs in the selected queue or jobs of the selected job type.
- Waiting jobs**  
Displays a list of jobs waiting in the print controller.
- Active jobs**  
Displays the jobs undergoing print processing while being processed by the print controller.
- Finished jobs**  
Displays a list of finished, cancelled, and failed jobs.

### Note:

- Clicking  on the upper-right corner of each list box minimizes the list box. Clicking  when the list box has been minimized returns the list box to the normal size. Clicking  on the upper-right corner of the **[Jobs in queue]** list box closes the list box.

## 7) Job / Queue information display

When the queue has been selected, the function icons and the general information of the selected queue are displayed.

When a job has been selected in the job list, the function icons and the general information of the selected job are displayed.

# Logging in to the Print Controller

There are the following three ways to log in to the print controller and three kinds of access authority.

- Without logging in (Guest user): The print controller is used without logging in. Only certain functions can be used.
- General user: Login using an “ID” and “Password” registered by the administrator. The general user has more authority over his/her own jobs than the administrator. However administrator settings are not available.
- Administrator: Login using an administrator “ID” and “Password”. The administrator can configure the administrator settings, such as print controller settings. [p.44](#)

## How to Log In

**Enter the “Login (ID)” and “Password” in the input area, and click the [Login] button.**

The “Login (ID)” and “Password” must be registered in the RISO Console by the administrator in advance.

[p.48](#)

For details, confirm with your network administrator.

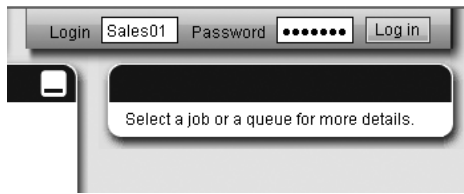

To log out, click the [Log out] button.

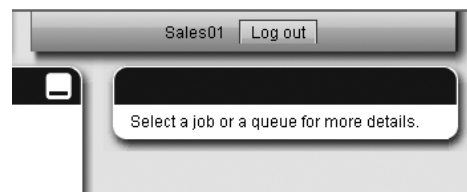

## Selecting Languages

Selects the language for messages displayed on the RISO Console screen.

**Move the mouse pointer over [Language] menu button, and select the language you want to use from the list.**

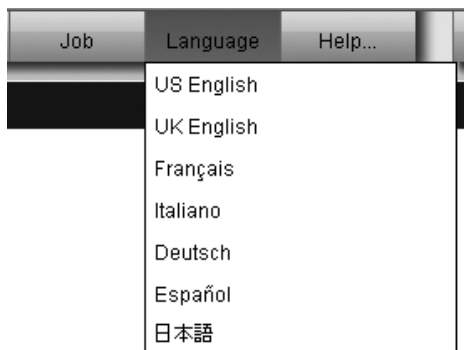

**Note:**

- The languages displayed on the RISO Console are memorized in the cookie of the web browser. Therefore, the language displayed when the RISO Console was last used will be enabled the next time the console is started up.

---

## Functions for Guest Users / General Users

---

When using the RISO Console without logging in (guest user) or logging in as a general user, the following functions are available on the RISO Console.

- Viewing detailed settings of the print controller [p.45](#)
- Viewing how job processing is distributed over the network by the print controller (load balancing settings) [p.54](#)
- Checking printer status [p.41](#)
- Checking the settings of the queue [p.10](#)

**Note:**

- When “Enforce login” ([p.48](#)) has been set, all the functions except for logging in are not available.

When “Others can see jobs” ([p.48](#)) has been set, the following functions are available for both guest users and general users.

- Viewing the list of jobs [p.14](#)
- Uploading jobs [p.12](#)
- Viewing detailed settings of jobs [p.19](#)
- Copying jobs [p.15](#)
- Changing job settings, moving jobs (only jobs without an owner’s name) [p.16](#), [p.19](#)
- Cancelling waiting jobs (only jobs without an owner’s name) [p.17](#)
- Importing archived jobs [p.40](#)
- Feeding back archived job [p.36](#)
- Overlaying archived jobs [p.39](#)
- Creating archive jobs [p.31](#)

When you log in as a general user, the following functions are available for your own jobs.

- Editing job settings [p.19](#)
- Deleting the job [p.16](#)
- Moving the job [p.16](#)
- Cancelling job processing [p.17](#)

# Queue

There are two types of queues - Normal and Hold. The two types of queues - “Normal” and “Hold” - are prepared for the print controller in advance. An arbitrary queue can be added by the administrator (Custom Queue).

## ◆ Normal queue:

This queue is for actually printing or storing jobs as archive jobs. The jobs sent to this queue from the computer are processed in chronological order.

## ◆ Hold queue:

This queue is for storing jobs. The jobs sent to this queue from the computer are stored in the print controller. To process jobs stored in the Hold queue, give commands such as printing a job, using the RISO Console. Storing original data that are frequently used or shared documents in the Hold queue enables to print them without opening the application and giving the command to print for every job from the RISO Console screen.

### Note:

- “Normal” and “Hold” queues are pre-registered at the factory. These queues cannot be deleted. Moreover, the following settings can be changed.
  - Normal: Queue password, priority, direct port, preferred PDL, prechecking setting
  - Hold: Queue password, prechecking setting
- The administrator can register various settings for processing jobs sent from the computer in the print controller as a Custom Queue. [p.69](#)  
By registering frequently used print settings as a Custom Queue and specifying queue settings priority, jobs can be printed in the same way without changing the settings many times by simply specifying a registered output queue.

## Checking Queue Settings

The processing conditions set for each queue can be checked as follows.

- 1 **Select a queue to check by clicking the Job / Queue selection button (on the left side of the screen).**

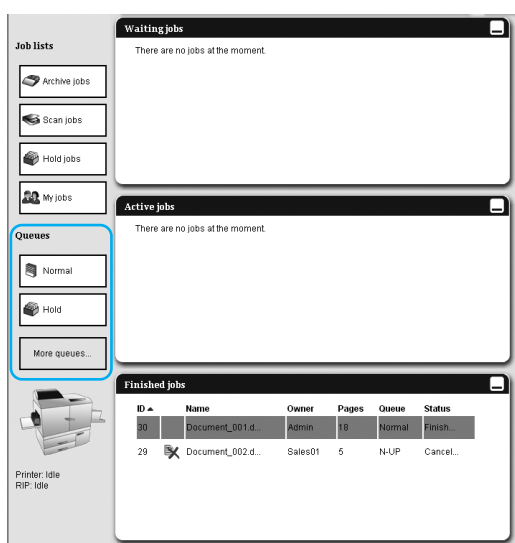

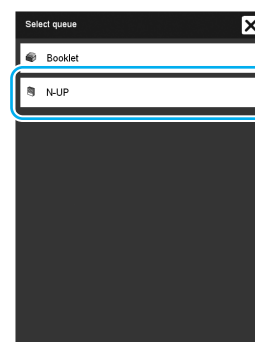

### Note:

- When the target queue button is not displayed in the screen, click the **[More queues...]** button, and select a queue from the list of queues.

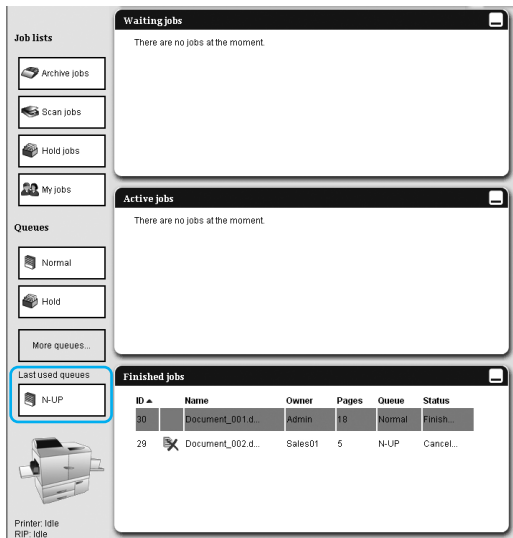

The button of the selected queue is displayed.



- 2** With no job selected, click  of the job / queue information display (on the right side of the screen).

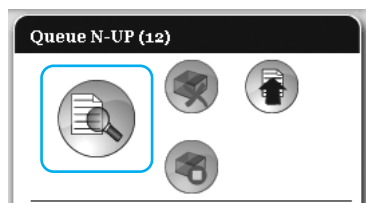

A details screen of the queue is displayed. Clicking the setting group icons at the top of the screen switches the details screen.

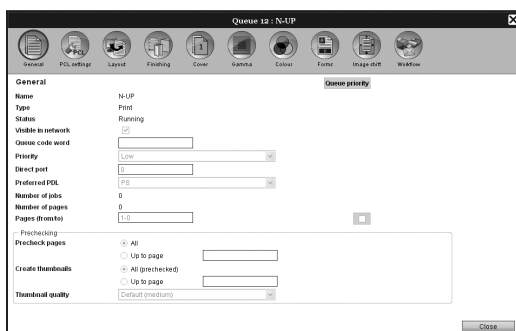

**Note:**

- A details screen of the queue can be also displayed by moving the mouse pointer over the **[Queue]** menu button and then clicking **[Queue details...]** in the displayed submenu.
- For displayed items, see “Changing Queue Detailed Settings”  p.71.

- 3** After checking the setup, click the **[Close]** button.

# Adding a Job to the Queue

You can directly add jobs to queues for processing on the RISO Console screen.

- 1 Click the queue button for adding the job from the Job/Queue selection buttons (on the left side of the screen).

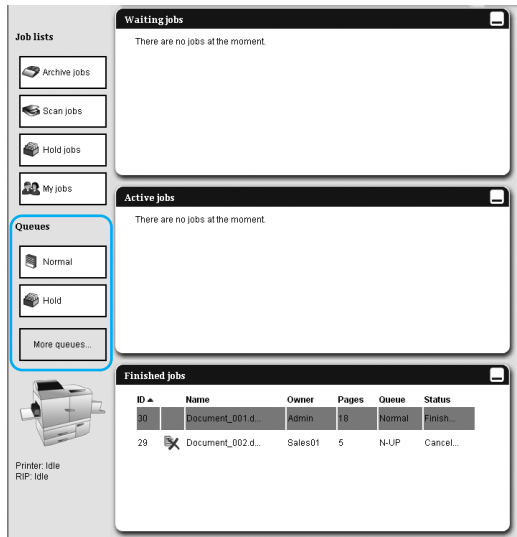

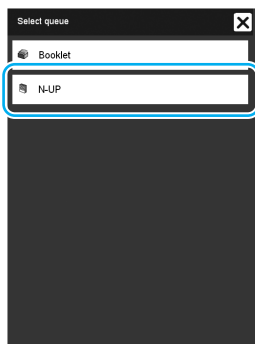

**Note:**

- When the target queue button is not displayed in the screen, click the **[More queues...]** button, and select a queue from the list of queues.

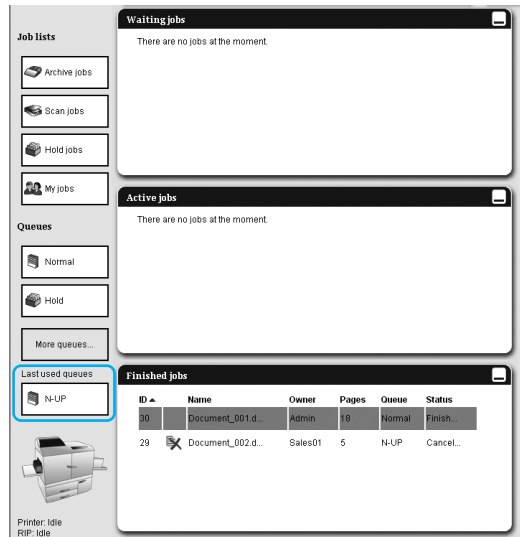

The button of the selected queue is displayed.



- 2 With no job selected, click  of the job / queue information display (on the right side of the screen).

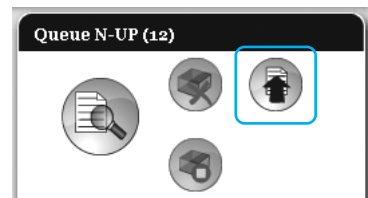

- 3 Select the file to add.

After clicking the **[Browse]** button, select the file on the file selection dialog box, and then click the **[Open]** button.

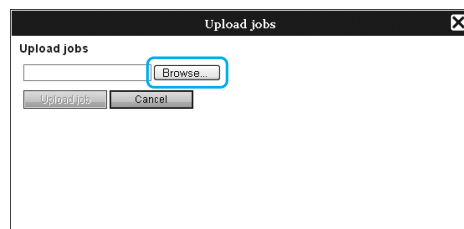

## 4 Click the [Upload job] button.



The job is added to the queue.

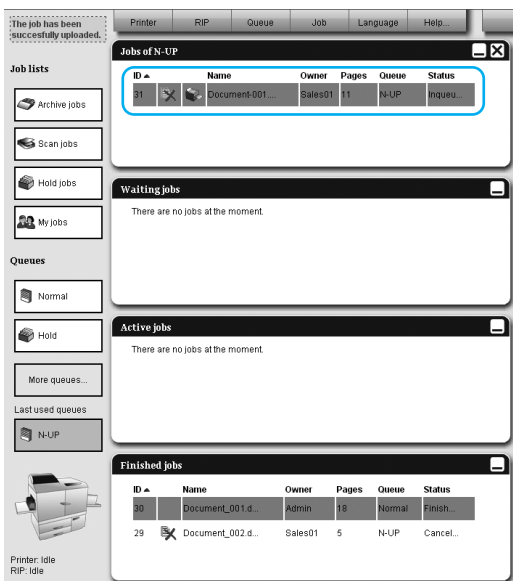

### Note:

- The job can also be added to the queue by moving the mouse pointer over the **[Queue]** menu button and then clicking **[Upload job...]** in the displayed submenu.

## Queue management

The administrator can operate queues as follows. [p.69](#)

- Create new queues [p.69](#)
- Delete queues [p.70](#)
- Edit settings for the queue [p.71](#)
- Stop / Resume queue processing [p.74](#)

# Jobs (Job manager)

The original data sent from the computer to the print controller is stored in the queue of the print controller as a job. Various operations can be performed using the RISO Console such as job copying, moving, deletion, queue setup viewing and editing. (The range of operations enabled for the job differs depending on the jobs are owned or not.)

## Job ownership

The user who sends a job to the print controller is the owner of that job. The owner of the job can operate the created job (copy, move, delete, edit settings, etc.) in various ways. Operation by other users than the job owner may be restricted by the administrator.

### Note:

- In the Hold queue of the print controller, three sample jobs are stored at the factory -PCL Font Sample Page, PS Font Sample Page, and Setting Page.  
Any user can print and change the settings of these sample jobs, but they cannot be deleted.

## Checking Job Status

- Click the queue button in which the job is stored from the Job / Queue selection button (on the left side of the screen).

A list of jobs stored in the queue is displayed.

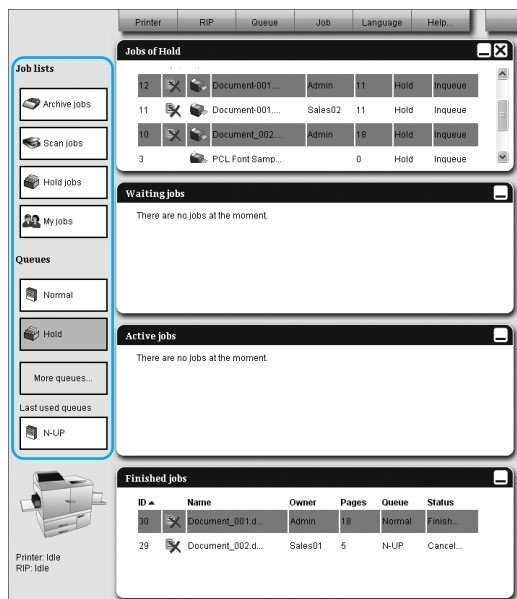

- Click the job you want to check in the job list.

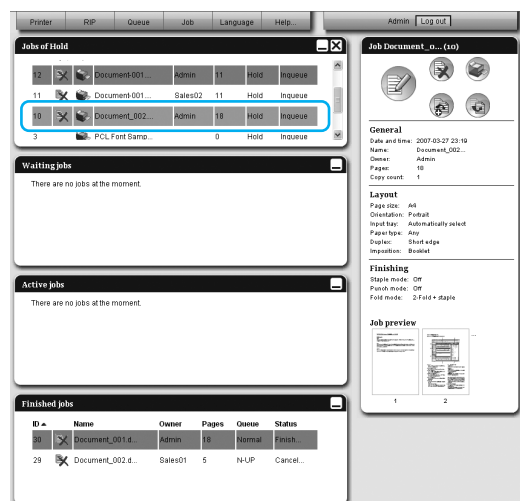

The information of the job is displayed in the Queue / Job information display (on the right side of the screen).

The following operations are available here.

- Viewing / Editing job details
- Printing a job
- Reprinting a job
- Copying a job (to another queue)
- Moving a job (to another queue)
- Deleting a job
- Cancelling a waiting/processing job
- Rearranging job display order
- Displaying thumbnails of a job (job preview)

### Note:

- Functions that cannot be operated according to job authority or administrator settings are greyed out and cannot be selected.  
For authorized functions, see "Functions That Guest Users / General Users Can Use". p.9



## Printing a Job

### 1 Select the job to print from the job list.

- To print a job registered in the Hold queue, select the job from the job list in the Hold queue.
- To print an archived job, select the job from the list of Archived jobs.
- To reprint a failed job, select the job from the list of Finished jobs.  
For details, see “Checking Job Status”. [p.14](#)

### 2 Click of the Job / Queue information display (on the right side of the screen).

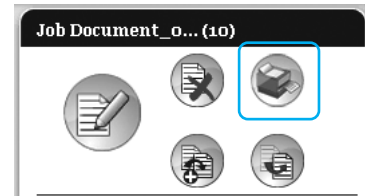

#### Note:

- Jobs can also be printed by moving the mouse pointer over the **[Job]** menu button and then clicking **[Print]** from the displayed submenu.
- Jobs can also be printed by clicking the print icon in the job list.

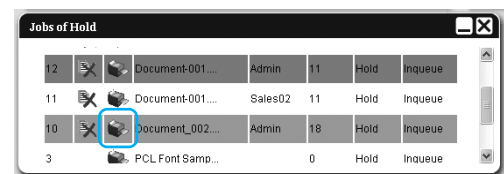

## Copying a Job to Another Queue

### 1 Select the job to copy from the job list.

For details, see “Checking Job Status”. [p.14](#)

### 2 Click of the Job / Queue information display (on the right side of the screen).

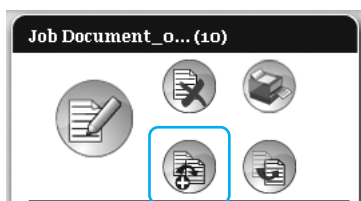

### 3 Select the destination queue to copy.

When the queue button is clicked, the job is added to the destination queue.

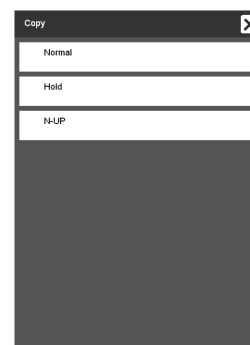

## Moving a Job to Another Queue

- 1 Select the job to move from the job list.**

For details, see “Checking Job Status”. ↗ p.14

- 2 Click  of the Job / Queue information display (on the right side of the screen).**

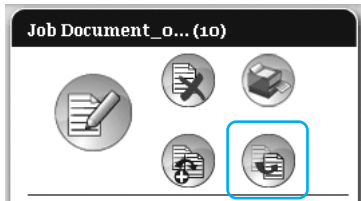

- 3 Select the destination queue to move.**

When the queue button is clicked, the job is deleted from the original queue and added to the destination queue.

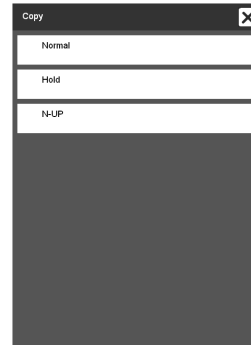

## Deleting a Job

- 1 Select the job to delete from the job list.**

For details, see “Checking Job Status”. ↗ p.14

- 2 Click  of the Job / Queue information display (on the right side of the screen).**

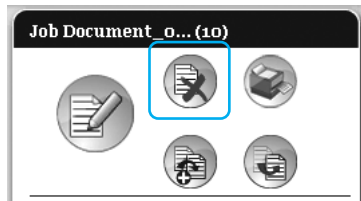

**Note:**

- The job can be also deleted by clicking the deletion icon in the job list.

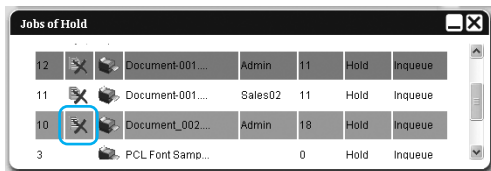

- 3 Click the [Yes] button in the confirmation dialog box.**

**Note:**

- To cancel job deletion, click the [No] button in the confirmation dialog box.

## Cancelling a Processing / Waiting Job

1 Click the job you want to cancel from the **[Active jobs]** or **[Waiting jobs]** list.

2 Click  of the **Job / Queue** information display (on the right side of the screen).



**Note:**

- The job can be also cancelled by clicking the cancel icon in the **[Active jobs]** or **[Waiting jobs]** list.

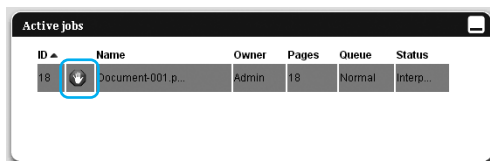

3 Click the **[Yes]** button in the confirmation dialog box.

**Note:**

- To cancel job cancellation, click the **[No]** button in the confirmation dialog box.

The information of the cancelled jobs is displayed in the **[Finished jobs]** list.

ID	Name	Owner	Pages	Queue	Status
18	Document-001.p...	Admin	18	Normal	Cancel...
12	Document_002.d...	Admin	5	Normal	Finished
11	Letterhead_00...	Sales02	1	Normal	Finished

**Note:**

- Cancelled jobs can be reprinted or deleted. You can select the job from the **[Finished jobs]** list, and print or delete it in the same way as normal jobs.

## Rearranging Job Display Order

The job list is normally displayed with the first job to process at the bottom. When you click an item header displayed above the list, the list of jobs is sorted according to that item. (The order of actual processing of jobs does not change.)

When you click the same item header repeatedly, the order alternative switches between ascending order and descending order.

When you return the display of the job list to the actual processing order, arrange **[ID]** in descending order (chronological order with the newest job first).

ID	Name	Owner	Pages	Queue	Status
14	Document001.d...	Sales01	1	Hold	Inqueue
13	SeminorReport...	Sales02	4	Hold	Inqueue
12	Document-001...	Admin	11	Hold	Inqueue

# Displaying Thumbnails of a Job (Job Preview)

## 1 Select the job from the job list in the queue.

A piece of the job thumbnail is displayed in the Job / Queue information display (on the right side of the screen).

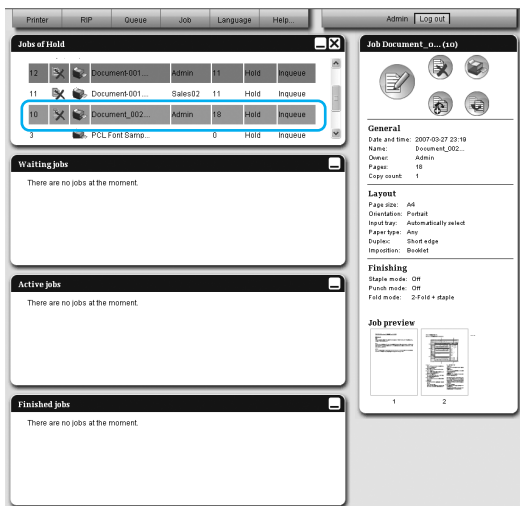

## 2 Click the job preview image.

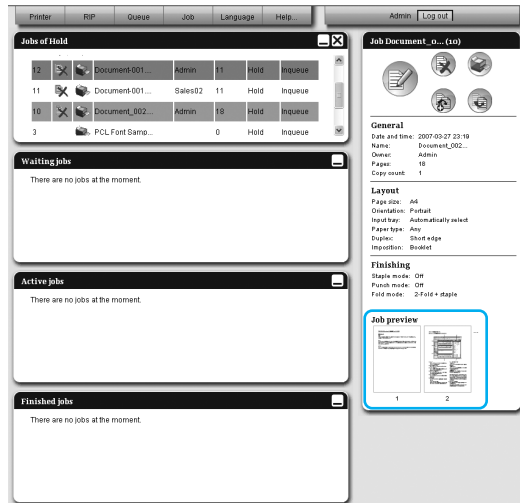

Thumbnails are displayed of all pages.

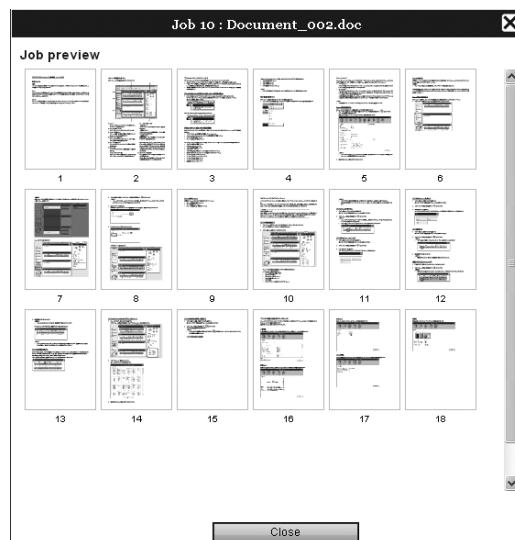

## 3 After checking, click the [Close] button.

## Viewing / Editing Job Details

### 1 Select the job to view / edit from the job list.

For details, see “Checking Job Status”. [p.14](#)

### 2 Click of the Job / Queue information display (on the right side of the screen).

The detailed settings screen for the job is displayed.

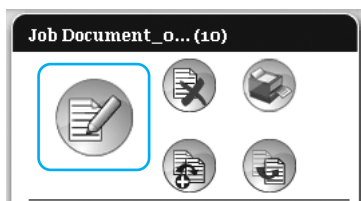

#### Note:

- When there is no authority on editing and operating the job,  is displayed. By clicking this icon, you can view detailed settings of the job. (Settings cannot be changed.)

### Detailed settings screen for the job (Editing screen)



### 3 Change the job processing settings if necessary.

When you click the icon at the top of the screen, the screen will switch.

**[OK]:** Click to save setting changes and end editing.

**[Apply]:** Click to save setting changes and continue editing.

**[Cancel]:** Click to cancel setting changes and end editing.

For an overview of settings on each screen, see the next page onward.

## [Basic] Screen

Configures settings for normal printing such as page size, orientation and paper type.

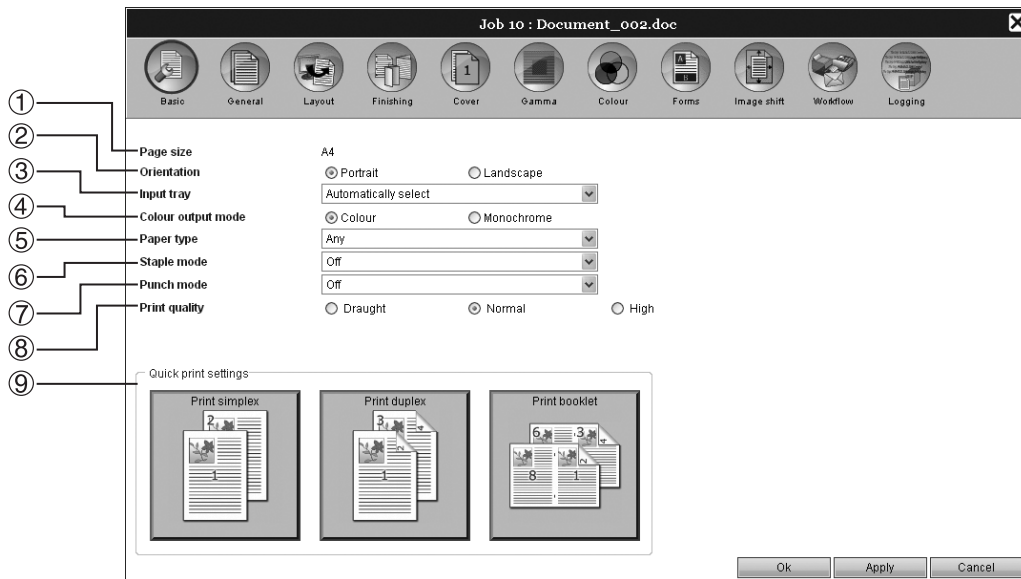

### Settings

- |   |  |
|---|--|
| <p><b>1) Page size</b><br/>Displays the size of the original.</p> <p><b>2) Orientation</b><br/>Selects the orientation for printing the original.</p> <p><b>3) Input tray</b><br/>Selects the tray holding the paper for printing.</p> <p><b>4) Colour output mode</b><br/>Selects colour or monochrome printing.</p> <p><b>5) Paper type</b><br/>Selects the paper type.</p> | <p><b>6) Staple mode*</b><br/>Staples printed paper.</p> <p><b>7) Punch mode*</b><br/>Punches holes in printed paper.</p> <p><b>8) Print quality</b><br/>Selects the print quality for originals to be printed.</p> <p><b>9) Quick print settings</b><br/>Click an optimal button for originals to be printed. Clicking this button closes the screen, and starts processing according to the selected layout.</p> |
|---|--|

\* The Staple mode and Punch mode are available when an HC Finisher is connected.

### Note:

- For details of settings, refer to the separate manual, "ComColorExpress IS700C Printer Driver Guide".

## [General] Screen

The outline information and basic settings are displayed for the job.

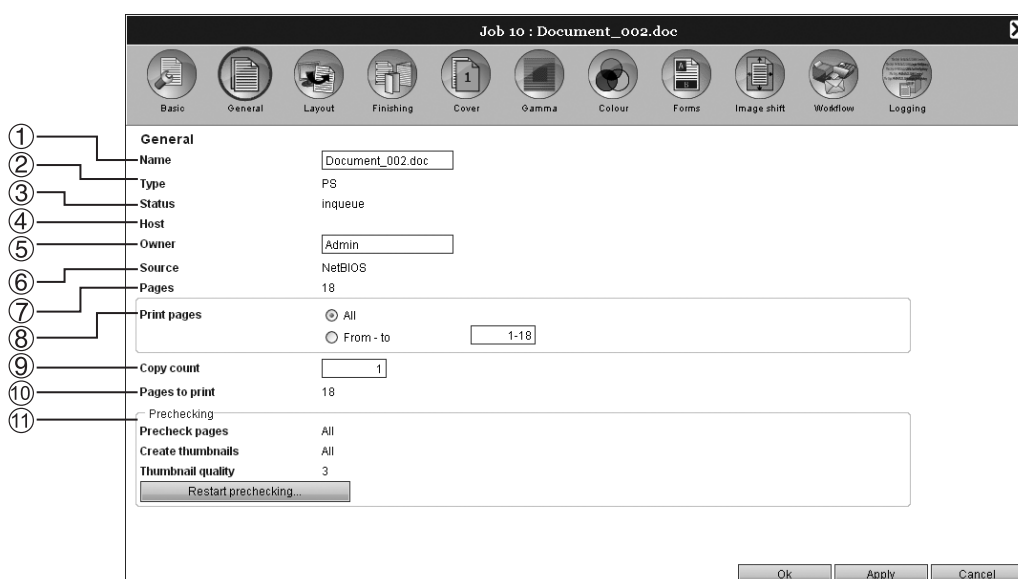

### Information displayed / Settings

- 1) Name\***  
Displays the name of the job.
- 2) Type**  
Displays the type of job.  
The types of jobs that can be used are as follows:  
PostScript(PS), PCL, PDF, TIFF, ASCII,  
PPML (as option)
- 3) Status**  
Displays the processing state of the job.
- 4) Host**  
Displays information on the job source (the name or IP address of the computer).
- 5) Owner\***  
Displays the owner name of the job.
- 6) Source**  
Displays information on the port through which the job has been received.
- 7) Pages**  
Displays the number of pages in the job.
- 8) Print pages**  
Specifies the pages to print.
- 9) Copy count**  
Specifies the number of copies to print.
- 10) Pages to print**  
Displays the total number of pages of the job (the number of pages of the original x the number of copies).
- 11) Prechecking\***  
Displays the data precheck (data quality check before output) setting.  
Clicking the **[Restart prechecking...]** button performs the data precheck processing. [p.72](#)

\*If you have the authority, it is possible to change or process the file.

#### Note:

- For details of settings, refer to the separate manual, "ComColorExpress IS700C Printer Driver Guide".

## [Layout] Screen

Configures the imposition method and enlargement / reduction rate for printing.



### Settings

#### 1) Imposition

Selects the type of imposition.

#### 2) Duplex

Selects whether or not to perform duplex printing.

#### 3) Imposition direction

Specifies for the arrangement sequence of output pages.

#### 4) Binding margin

Sets the binding margin width.

#### 5) Auto-reducing

When a checkmark is placed, any image that is not included in the image area because of the margin width will be automatically reduced so that the image is included in the image area of the paper.

#### 6) N-Up

If [N-Up] is selected at [Imposition], set the arrangement of pages and the number of pages per sheet for imposition.

#### 7) Page size

Displays the size of the original.

#### 8) Orientation\*

Selects the orientation for printing the original.

#### 9) Output size

Selects the paper size for printing.

#### 10) Scale to fit

Places a checkmark in order to print the original data with its size automatically enlarged / reduced to fit the output paper size.

#### 11) Zoom

Specifies the enlargement / reduction rate for printing.

#### 12) Rotate 180 degrees

The orientation of originals printed on paper can be rotated by 180° and printed.

\*If you set [Orientation] in the [Basic] screen, settings are applied here.

#### Note:

- For details of settings, refer to the separate manual, "ComColorExpress IS700C Printer Driver Guide".



## [Finishing] Screen

Configures paper output settings such as collating.

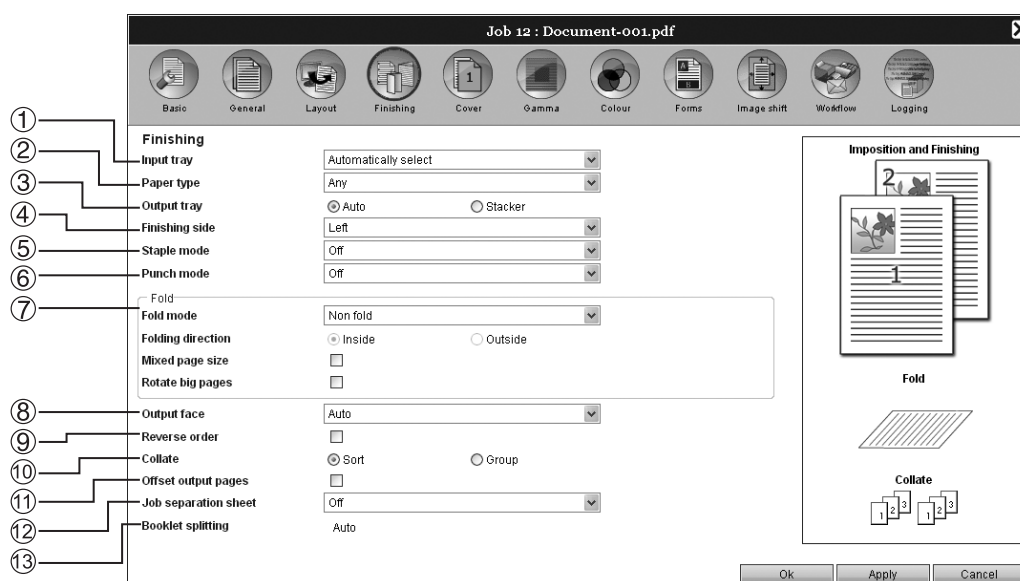

### Settings

- 1) Input tray\*<sup>1</sup>**  
Selects the tray holding the paper for printing.
- 2) Paper type\*<sup>1</sup>**  
Selects the paper type.
- 3) Output tray\*<sup>2</sup>**  
Specifies the destination tray.
- 4) Finishing side\*<sup>2</sup>**  
Specifies the finishing side for stapling or hole-punching.
- 5) Staple mode\*<sup>1\*2</sup>**  
Staples printed paper.
- 6) Punch mode\*<sup>1\*2</sup>**  
Punches holes in printed paper.
- 7) Fold\*<sup>2</sup>**  
Fold mode: Outputs paper that has been folded into two.
- 8) Output face**  
Selects the output face of the print paper.
- 9) Reverse order**  
Prints originals in reverse order.
- 10) Collate**  
Selects whether multiple pages are printed as sets of pages, or printed in groups of individual pages.
- 11) Offset output pages\*<sup>3</sup>**  
Outputs paper at an offset position for each printing set.
- 12) Job separation sheet**  
Inserts a sheet of paper from a tray different to the tray holding the paper being printed as a separator.
- 13) Booklet splitting**  
Splits a booklet into multiple books when making a booklet.

\*<sup>1</sup> If you set the **[Input tray]**, **[Paper type]**, **[Staple mode]** and **[Punch mode]** in the **[Basic]** screen, settings are applied here.

\*<sup>2</sup> This function is available when an HC Finisher is connected.

\*<sup>3</sup> This function is available when a Finisher is connected.

### Note:

- For details of settings, refer to the separate manual, "ComColorExpress IS700C Printer Driver Guide".

## [Cover] Screen

Configures the settings for printing covers.

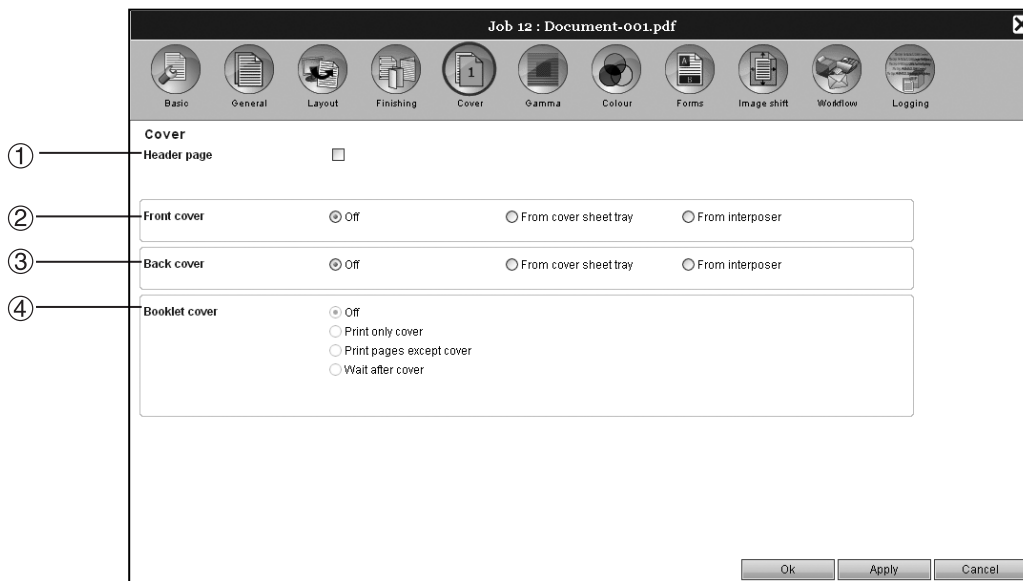

### Settings

#### 1) Header page

Prints a job name / owner name, etc. to discern who printed.

#### 2) Front cover

Selects the tray on which the front cover sheet is loaded. The front cover is inserted before the first page of the original and outputted. The tray can be selected either **[From cover sheet tray]** installed in the finisher or **[From interposer]** set on the panel of the printer.

#### 3) Back cover

Selects the tray on which the back cover sheet is loaded. The back cover is inserted after the last page of the original and outputted. The tray can be selected either **[From cover sheet tray]** installed in the finisher or **[From interposer]** set on the panel of the printer.

#### 4) Booklet cover

Prints and outputs cover pages and other pages separately. This function is useful for printing the covers onto paper that is different with the paper of the body of the original.

#### Note:

- For details of settings, refer to the separate manual, "ComColorExpress IS700C Printer Driver Guide".

## [Gamma]Screen

Adjusts settings such as the resolution, colour output mode, density and contrast of images.

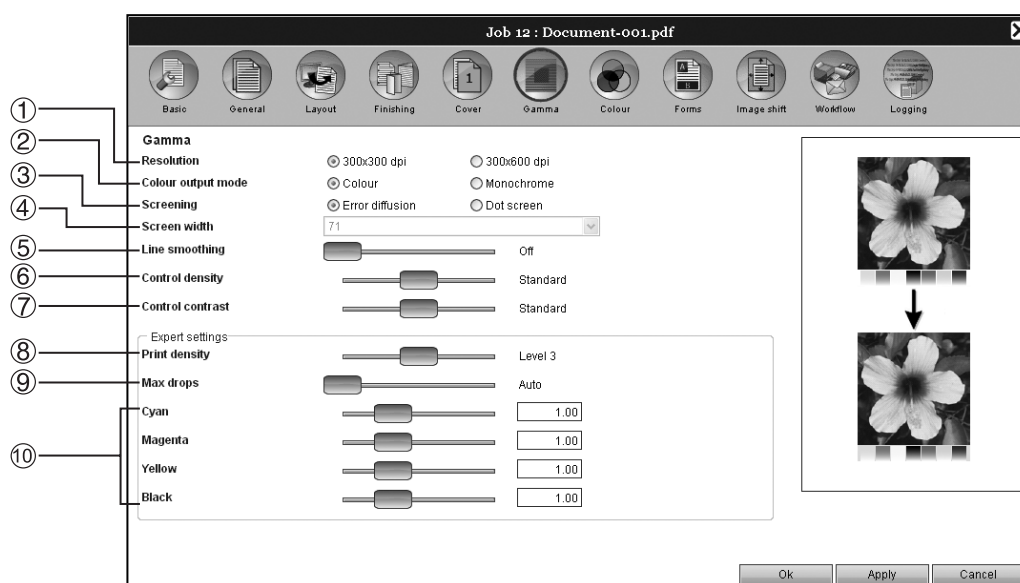

### Settings

- 1) Resolution (dpi)**  
Sets the image quality (resolution).
- 2) Colour output mode**  
Selects colour or monochrome printing.
- 3) Screening**  
Selects the method of half-tone processing.
- 4) Screen width**  
Sets the screen width (resolution, line per inch).
- 5) Line smoothing**  
Selects the method of line smoothing.
- 6) Control density**  
Adjusts the density of images.
- 7) Control contrast**  
Adjusts the contrast of images.
- 8) Print density**  
Adjusts the print density.
- 9) Max drops**  
Sets the maximum amount of ink drops.
- 10) Gamma adjustment (Cyan, Magenta, Yellow, Black)**  
Adjusts the gamma level for each colour.

### Note:

- For details of settings, refer to the separate manual, "ComColorExpress IS700C Printer Driver Guide".

## [Colour] Screen

Some image data colours may not be reproducible.

In this case, 4 types of rendering intent and colour profiles are used, and mapping (image compression) and colour conversion is performed to reproduce colours as close to the original as possible or natural colour tones.

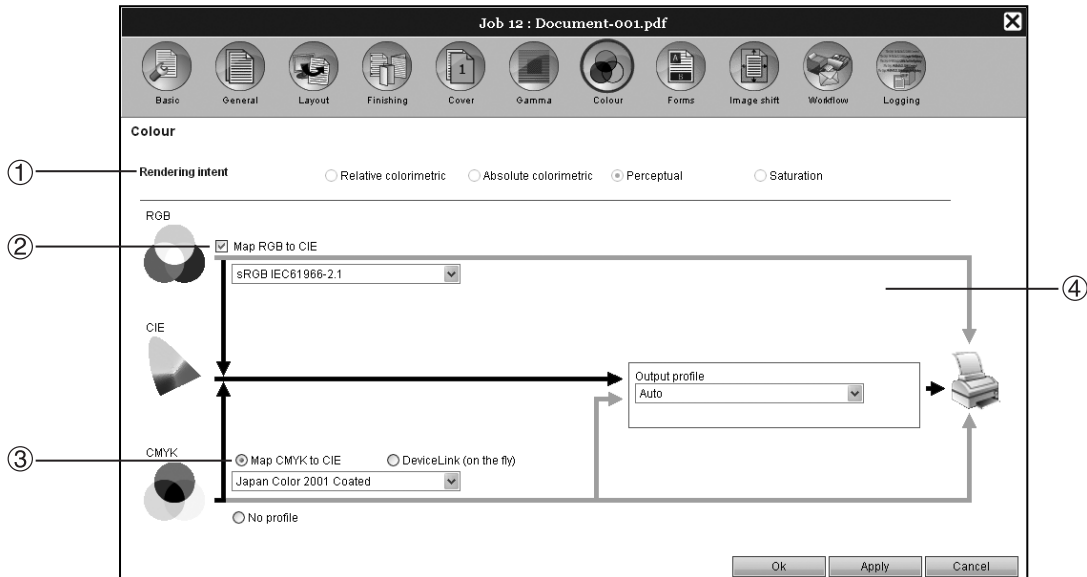

### Settings

#### 1) Rendering intent

Uses four different types of colour conversion to reproduce colours.

#### 2) RGB: Map RGB to CIE

An RGB input profile can be selected when a checkmark is placed.

#### 3) CMYK: Map CMYK to CIE/ DeviceLink (on the fly)/ No profile

A CMYK input profile or DeviceLink profile can be selected.

#### 4) Output profile

[Auto] or output profiles added arbitrarily can be selected.

### Note:

- When [Output profile] is set to [Auto], [Rendering intent] cannot be selected.
- For details of settings, refer to the separate manual, "ComColorExpress IS700C Printer Driver Guide".

## [Forms] Screen

Selects a form (archived job) registered in the print controller and prints output data overlaid on a form.

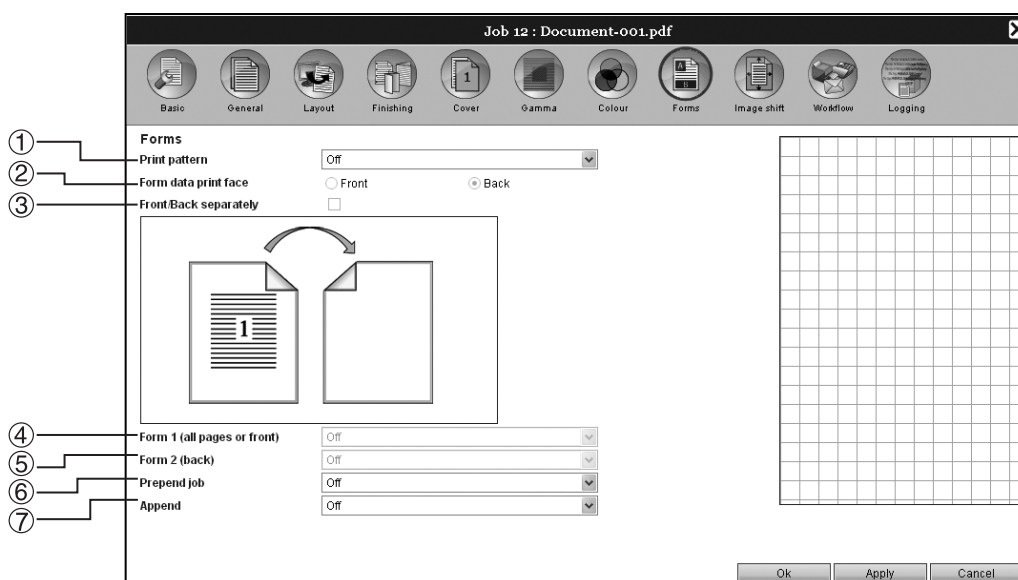

### Settings

#### 1) Print pattern

Sets whether or not to print a form (archived job) onto the same face as output data.

#### 2) Form data print face

Selects whether to print a form (archived job) onto the front side or the back side when **[Overlay alternating]** or **[Overlay alternating + each page]** is selected.

#### 3) Front/Back separately

Specifies and prints different forms (archived jobs) for each side when duplex printing.

#### 4) Form 1 (all pages or front)

Selects the form (archived job) printed on the front side or both sides of the output data.

#### 5) Form 2 (back)

Selects the form (archived job) printed on the back side the output data.

#### 6) Prepend job\*

Selects the form (archived job) added before the output data.

#### 7) Append\*

Selects the form (archived job) added after the output data.

\*The optional "IS700C Advanced Package" or "IS700C Professional Package" is required for using this function.

#### Note:

- For details of settings, refer to the separate manual, "ComColorExpress IS700C Printer Driver Guide".

## [Image shift] Screen

Adjusts the vertical and horizontal margins of the originals images.



### Settings

#### 1) Horizontal shift

Adjusts the print position horizontally between -254 mm (-10") and 254 mm (10").

#### 2) Vertical shift

Adjusts the print position vertically between -254 mm (-10") and 254 mm (10").

#### 3) Shift front/back separately

When duplex printing, both front and back sides can be adjusted independently.

#### 4) Horizontal shift back side

Adjusts the print position on the back side horizontally between -254 mm (-10") and 254 mm (10").

#### 5) Vertical shift back side

Adjusts the print position on the back side vertically between -254 mm (-10") and 254 mm (10").

#### 6) Print position

Selects a standard position allocated to the original image on the paper.

### Note:

- For details of settings, refer to the separate manual, "ComColorExpress IS700C Printer Driver Guide".

## [Workflow] Screen

Configures settings for the output destination of the original, and output operation and notification method.



### Settings

#### 1) Destination

Selects whether data sent from the computer is printed onto papers, or is stored as an archived job in the print controller.

#### 2) Wait after proof

Prints one page or one set only, and enables you to check the printed sheet(s) of paper.

#### 3) Secure print

Displays whether the secure print (printing the job using a password) has been specified or not. (This setting cannot be changed.)

#### 4) Job delegation

When several print controllers of the same model are connected on the network, jobs are delegated to each print controller for processing.

#### 5) Send Windows message\*

Notifies the job status using the "NET SEND" function of the Windows OS.

#### 6) Send E-mail

Sends a job status email message to a specified email address.

#### 7) Job splitting

Splits one job into multiple jobs.

#### 8) Comment

Enter comments displayed at [Job Details] of the print controller.

\* This setting cannot be used in Mac OS X.

### Note:

- For details of settings, refer to the separate manual, "ComColorExpress IS700C Printer Driver Guide".

## [Logging] Screen

Displays records of print controller processing for the selected job.

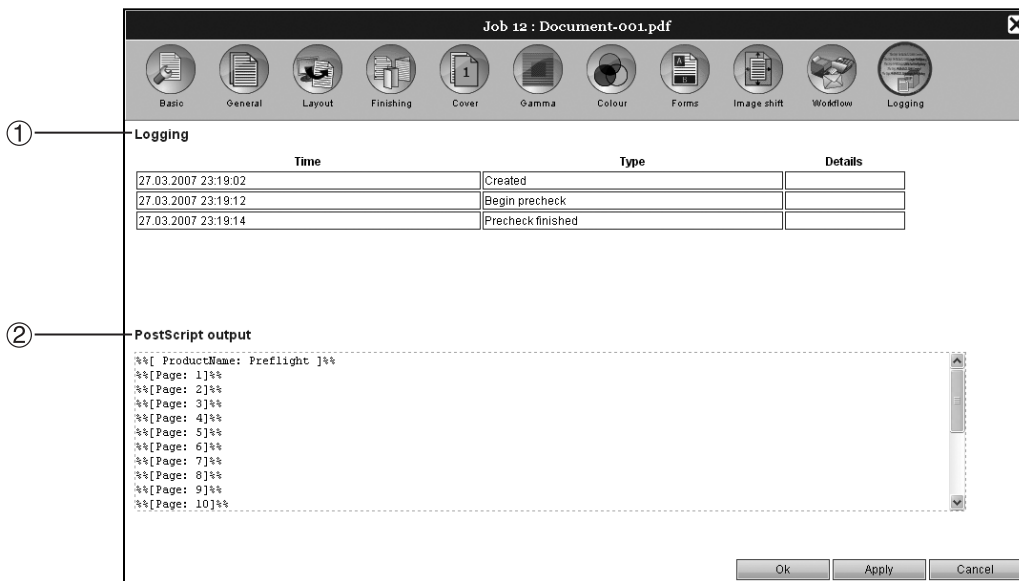

### Information displayed

#### 1) Logging

Displays the time when each processing was executed, processing conditions, and detailed information.

#### 2) PostScript output

Displays information such as error codes that occurred during PostScript conversion.



# Using RIP Data (Archived jobs)

The print controller makes it possible to create and store the RIP data (archived jobs). The following operations can be performed with that data.

- Printing  
Store archived jobs can be repeatedly printed from the RISO Console. Archived jobs can be printed by shortening the time required for RIP.
- Feedback  
Downloads as image data  
Downloads archive data to a computer
- Merging
- Use as forms

## Creating Archived Jobs

In order to create archived jobs, the following methods are available.

- When printing original data from the computer, set the **[Destination]** to **[Archive]** or **[Print & Archive]** in the **[Workflow]** screen of the printer driver.  
For details, refer to the separate manual, "ComColorExpress IS700C Printer Driver Guide".
- For jobs sent to the print controller, set the **[Destination]** to **[Archive]** or **[Print & Archive]** in the **[Workflow]** screen of the job details screen. [p.29](#)
- By overlaying the existing archived jobs, create a different archive job. [p.39](#)

### Note:

- The Secure print function cannot be set with data to be output to an archive. Data output to an archive can be freely accessed from the RISO Console. It is recommended not to output confidential documents to archives.

## Printing Archived Jobs

- 1 Click **[Archive jobs]** button from the **Job/Queue selection** button (on the left side of the screen).

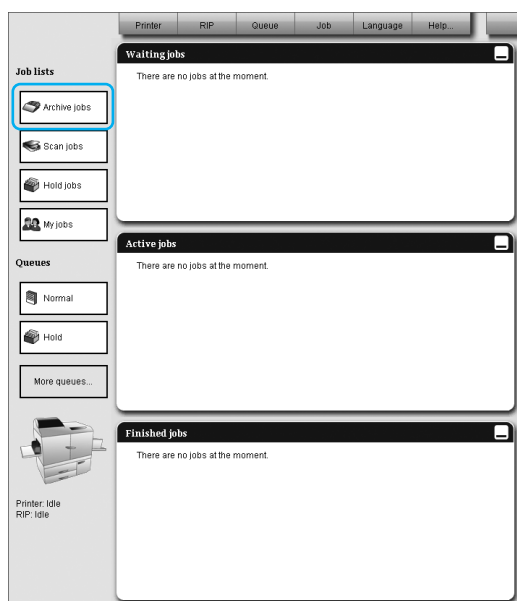

- 2 Select the job to print from the list of archived jobs.

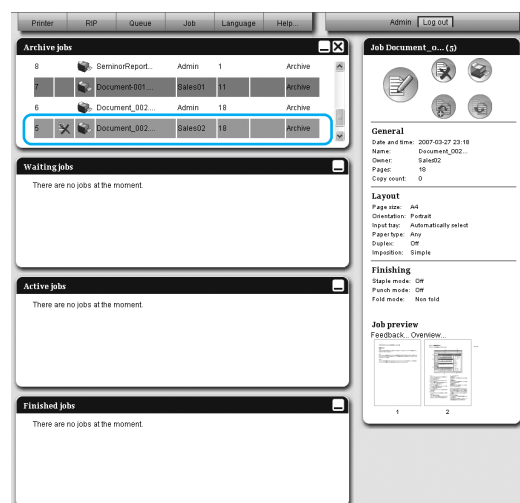

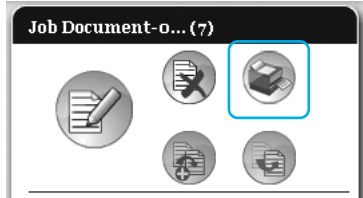

**3** Click  of the Job / Queue information display (on the right side of the screen).

Printing will start.



**Note:**

- For changing the print settings;
  - 1) Click  of the Job / Queue information display (on the right side of the screen).
  - 2) For instruction on changing settings on the Job details setting screen, see “Viewing / Editing Job Details”. p.19
  - 3) Click  of the Job / Queue information display (on the right side of the screen). Printing will start at the new settings.
- The job can also be printed by clicking the print icon on the job list.

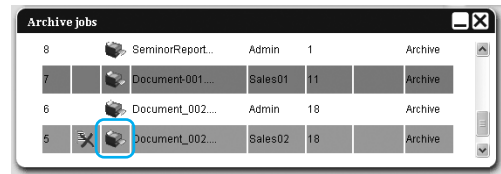

## Editing Archived Jobs

**1** Click the [Archive jobs] button from the Job/Queue selection button (on the left side of the screen), and select the job to edit from the list of archived jobs.

For details, see steps 1 and 2 in “Printing Archived Jobs”. p.31

**2** Click [Overview] in the Job preview.

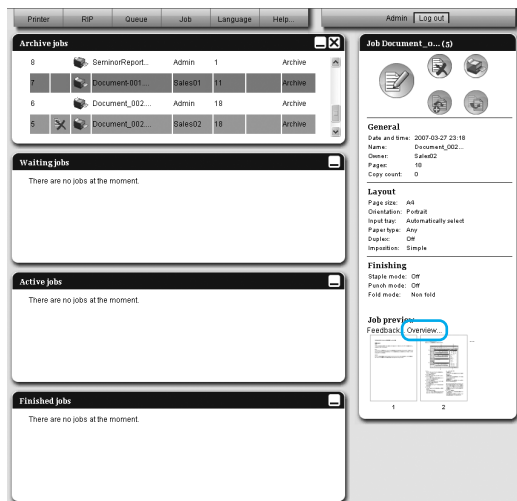

Thumbnails are displayed for all pages.

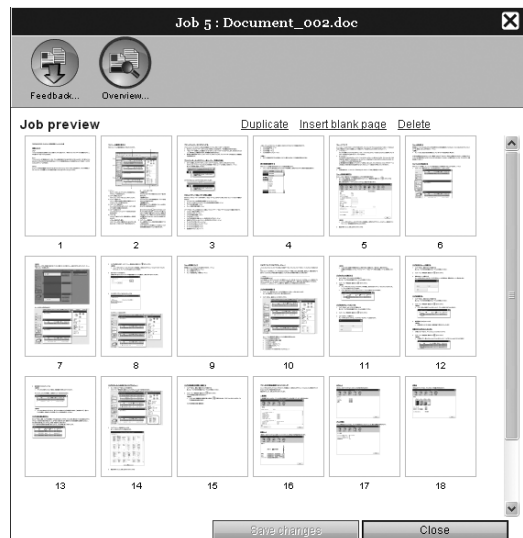

**Note:**

- The preview screen can be also displayed by moving the mouse pointer over the [Job] menu button and then clicking [Overview...] in the displayed submenu.
- Double-clicking the page opens an enlarged image of the page in a different screen.

### 3 Edit the archived data.

The following operations are available on the preview screen.

- Moving pages\* [p.33](#)
- Copying pages\* [p.34](#)
- Inserting blank pages\* [p.34](#)
- Deleting pages\* [p.35](#)

**Note:**

- In order to use the function of editing the archived data(\*), the optional “IS700C Advanced Package” or “IS700C Professional Package” is required.
- Pages can be copied from multiple archived data and merged. For details, see “Merging Pages from Multiple Archive Jobs”. [p.39](#)

### 4 Save the edited archived data.

- 1) Click the **[Save changes]** button on the preview screen.
- 2) Enter the new job name, and click the **[OK]** button.  
After the job is processed, it is added to the list of archived jobs.

**Note:**

- To not save the edited archived data, click the **[Close]** button on the preview screen, and click the **[Yes]** button in the confirmation dialog box.

### Moving Pages

Select the page on the preview screen of the archived job, and drag and drop the page in the location you want to move it to.

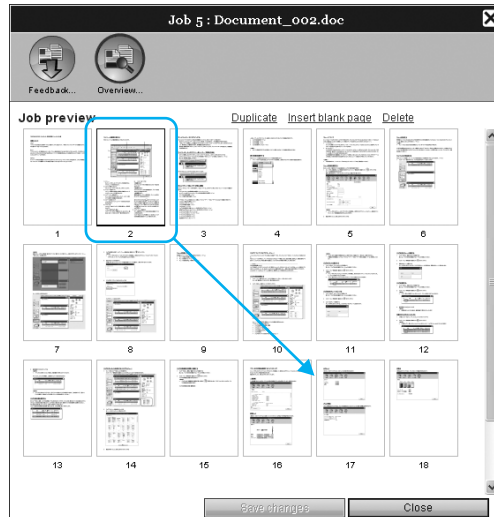

The selected page is moved to the location in front of the selected page.



### Copying Pages [Duplicate]

- 1 Select the page to copy on the preview screen of the archived job.
- 2 Click [Duplicate].



The copied page is added after the original page.

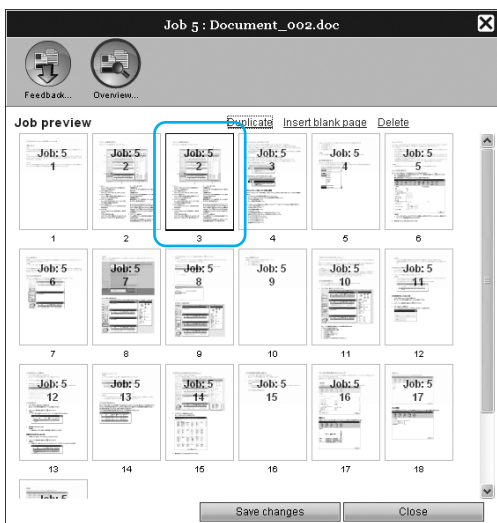

### Adding Blank Pages [Insert blank page]

- 1 Select the location (next page) where to insert the blank page on the preview screen of the archived job.
- 2 Click [Insert blank page].

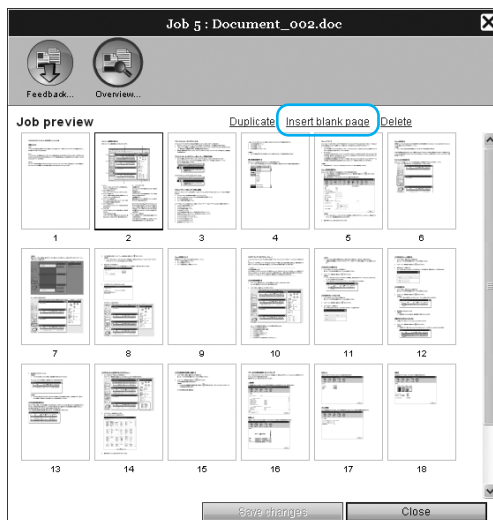

The blank page is added in front of the selected page.

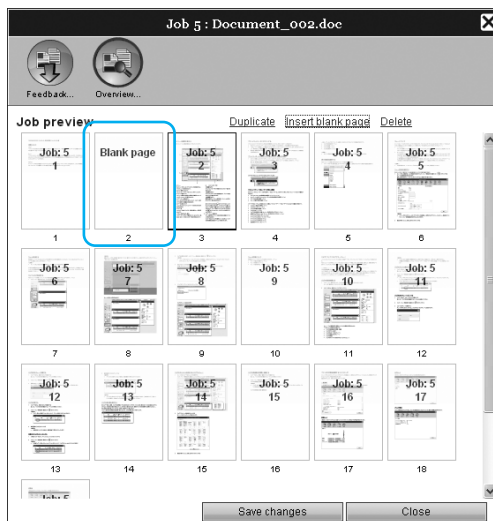

## Deleting Pages [Delete]

- 1 Select the page to delete on the preview screen of the archived job.
- 2 Click [Delete].

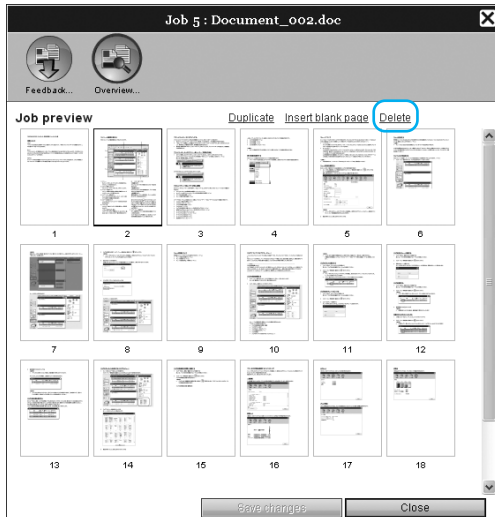

The selected page is deleted.

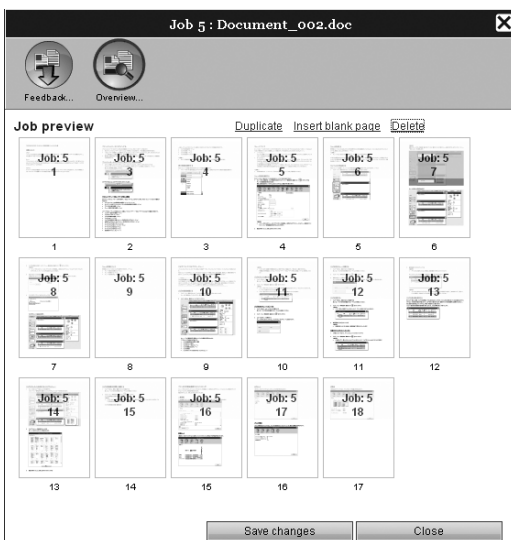

# Downloading Archived Jobs to the Computer

**1** Click the [Archive jobs] button from the Job/Queue selection button (on the left side of the screen), and select the job you want to download from the list of archived jobs.

For details, see steps 1 and 2 in “Printing Archived Jobs”. p.31

**2** Click [Feedback] in the Job preview.

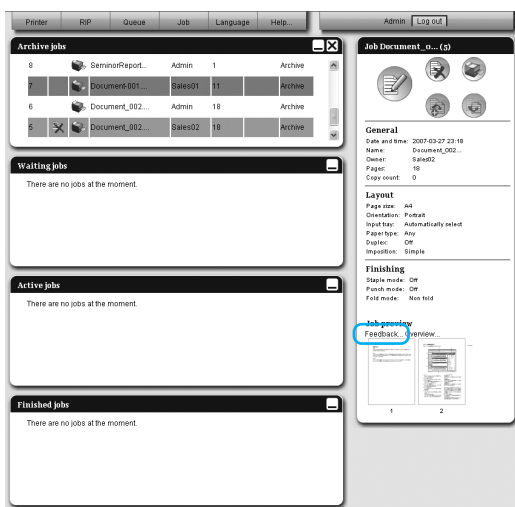

The feedback setting screen is displayed.

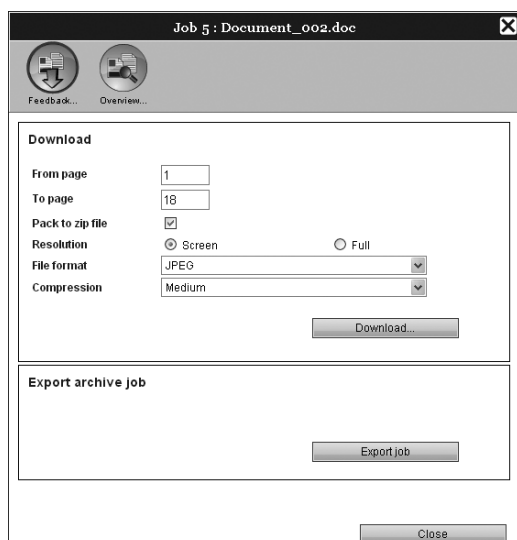

**Download by either image or PDF format**

**1** Specify the data format to download, etc. on the feedback setting screen.

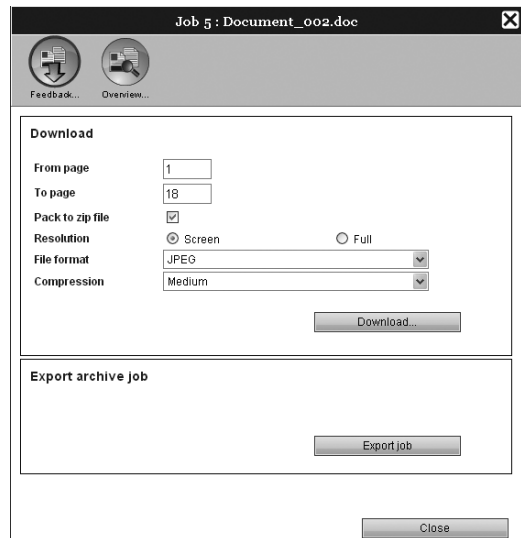

- **[From page][To page]:** Specify the page to download from the archived data.
- **[Pack to zip file]:** When placing a checkmark, a zip-compressed job is saved. (The extension is .zip) This cannot be set for “PDF” format.
- **[Resolution]**  
**[Screen]:** Downloads the image with the resolution for screen display (75dpi).  
**[Full]:** Downloads the image with the resolution for printing. This image can be used for checking before actual printing.
- **[File format]:** Select the file format to download (TIFF, PDF, PNG, or JPEG).
- **[Compression]:** Select the compression level (Lowest, Low, Normal, High, or Highest). This cannot be set for “TIFF” format.

**Note:**

- Image data (TIFF) or PDF data can be also downloaded by moving the mouse pointer over the [Job] menu button and then clicking [Feedback...]
- When printing data downloaded in the [Full] setting, be sure to use a RISO high-speed colour printer.

- 2 Click the [Download...] button.
- 3 Click the [Save] button.
- 4 Specify the destination folder and file name, and click the [Save] button.

The data is saved in the specified folder.

## Downloading Archived Jobs

- 1 Click [Export job] in the feedback setting screen.



### Note:

- The archived data can be also downloaded by moving the mouse pointer over the [Job] menu button and then clicking [Export] in the displayed submenu.

- 2 Click the [Save] button.

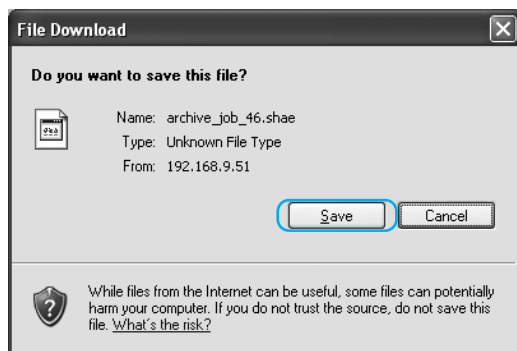

- 3 Specify the destination folder and file name, and click the [Save] button.

The data is saved in the specified folder.

### Note:

- The extension of the archived data is “.shae”.
- The downloaded archive data can be also imported to the print controller. For details, see “Importing Archived Jobs from the Computer”. [p.40](#)

## Merging Multiple Archived Jobs

Multiple archived jobs in the print controller can be selected and merged.

**Note:**

- The optional “IS700C Advanced Package” or “IS700C Professional Package” is required for using this function.

### 1 Selects the jobs to merge from the list of archived jobs.

Click the arbitrary jobs and select while holding down the **[Ctrl]** key of the computer.

You can also select them by specifying the range of jobs while holding down the **[Shift]** key.

(For Macintosh computers, select by specifying the range of jobs while holding down the **[Shift]** key.)

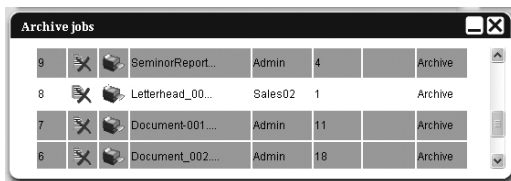

**Note:**

- Archived jobs are merged in the order of selection.
- To cancel the selection, click the jobs you want to cancel while holding down the **[Ctrl]** key.

### 2 Move the mouse pointer over the [Job] menu button and then click [Merge] in the displayed submenu.

### 3 Enter the new job name, and click the [OK] button.

After the job is processed, it is added to the list of archived jobs.



## Merging Pages from Multiple Archived Jobs

### Note:

- The optional “IS700C Advanced Package” or “IS700C Professional Package” is required for using this function.

### 1 Select the job to edit from the list of archived jobs, and display the preview screen.

For details, see “Editing Archived Jobs”. p.32

### 2 In the same way, display the preview screen of the archived jobs to merge.

### 3 Select the page to copy, then drag and drop the page at the merging location.

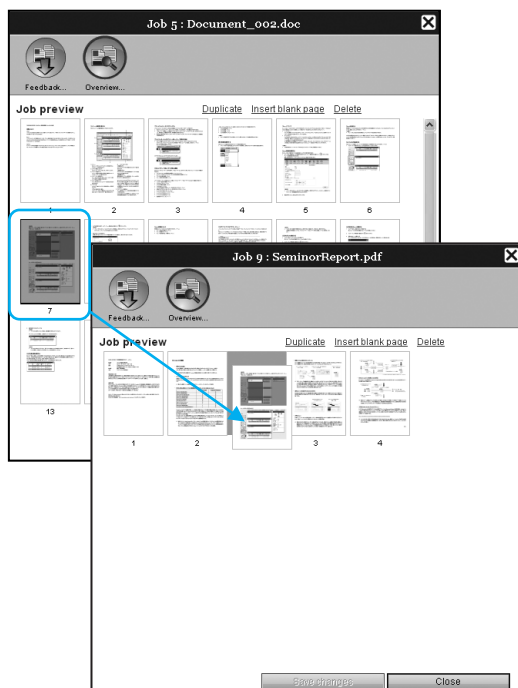

The selected page is added to the merging location (before the specified page).

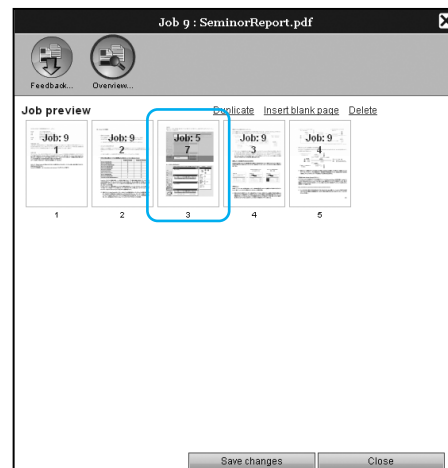

### 4 Save the merged archived data.

- Click the [**Save changes**] button on the preview screen.
- Enter the new job name, and click the [**OK**] button.  
After the job is processed, it is added to the list of archived jobs.

### Note:

- To not save the merged archived data, click the [**Close**] button on the preview screen, and click the [**Yes**] button in the confirmation dialog box.

# Importing a Archived Job from the Computer

Archived jobs saved in the computer (the extension is .shae) can be imported to the print controller. Archived jobs (extension is .shae) can be saved by exporting archived jobs or using the backup function of archived jobs. (p.36, p.59)

- 1 Click the [Archive jobs] button from the Job/Queue selection button (on the left side of the screen).

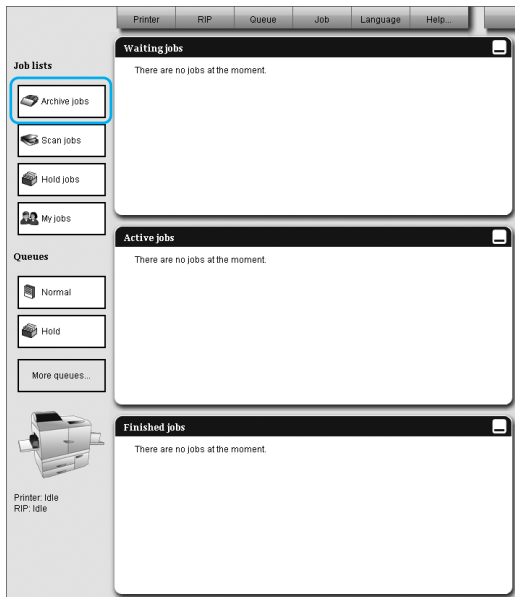

- 2 Click  of the Job / Queue information display (on the right side of the screen).

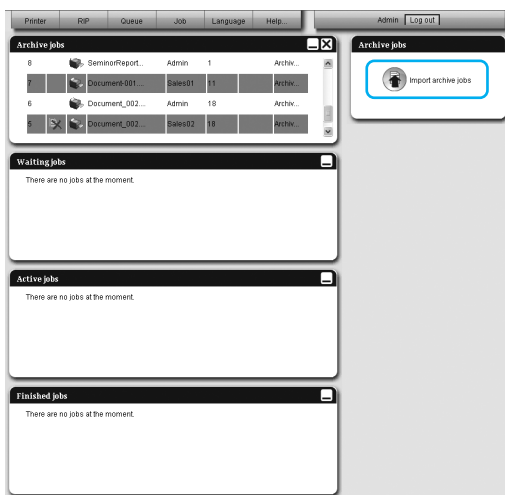

The Import archived job screen is displayed.



- 3 Click the [Browse] button, and select the archived job.  
After specifying the archived job on the file selection screen, click the [Open] button.
- 4 Click the [Import job] button.  
The archived job is imported and added to the list of archived jobs.

# Checking Printer Status

The status screen of the printer can be displayed by moving the mouse pointer over the **[Printer]** menu button and then clicking **[Printer details...]** in the displayed submenu. After finished checking, click the **[Close]** button.

## General

Clicking **[General]** displays the information on the printer and printer status.

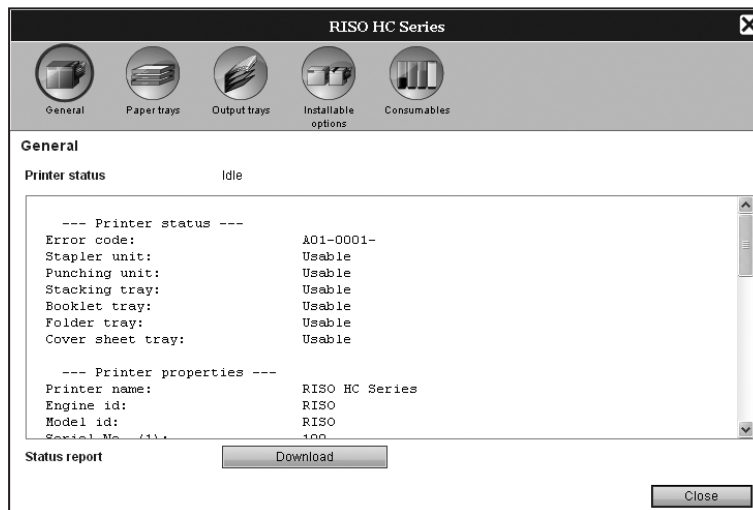

## Paper trays

Clicking **[Paper trays]** displays the paper set in the paper tray, paper quantity, and availability for auto tray selection.

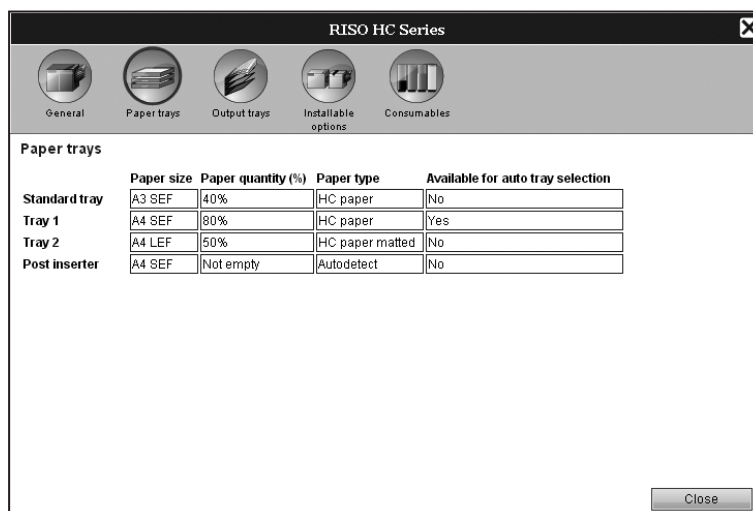

## Output trays

---

Clicking **[Output trays]** displays the status of the output tray.

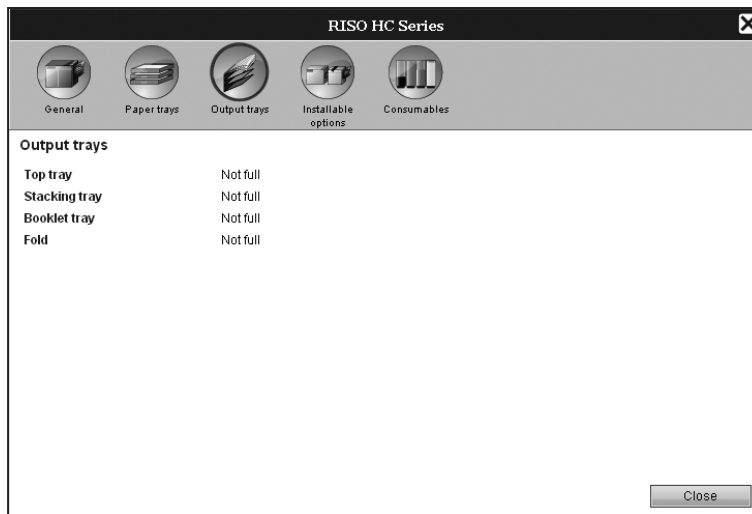

## Installable options

---

Clicking **[Installable options]** displays the information on the finisher connected to the printer.

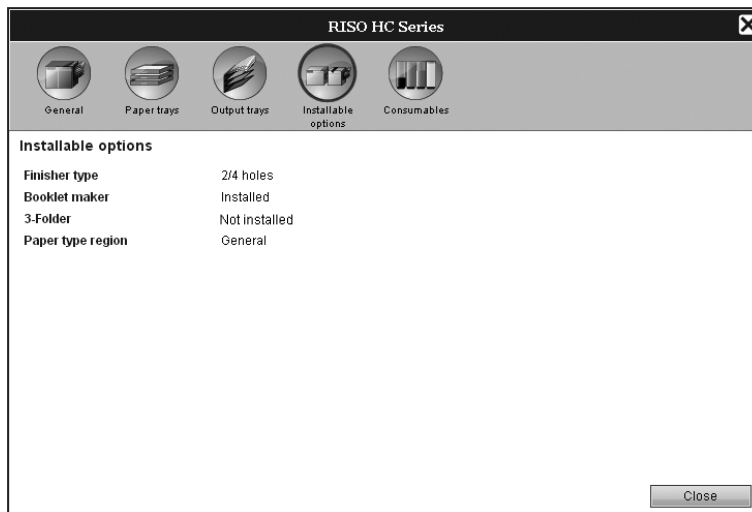

## Consumables

Clicking [**Consumables**] displays the remaining amount of ink in the printer.

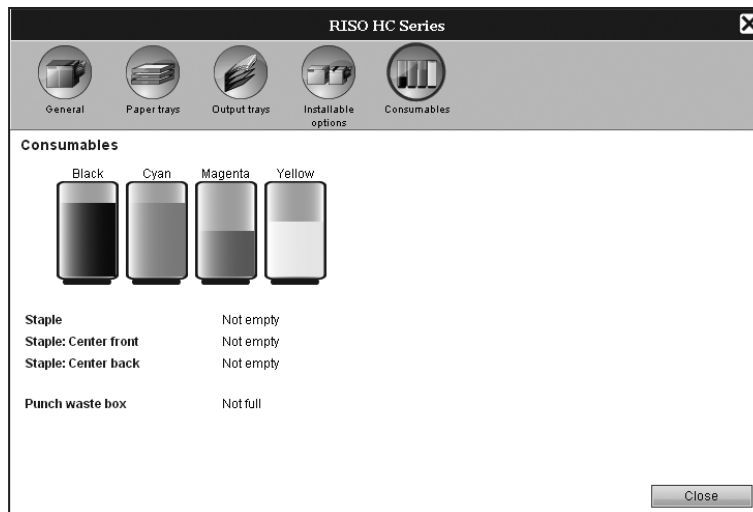



# Administrator Settings

This section describes the administrator settings of the RISO Console (the available functions for administrator).

## Administrator

The administrator is a user that has the authority to change the settings of the print controller, add queues, and register general users, etc. by logging in as an administrator.

### Note:

- For categories of use authority (guest user / general user / administrator), see “Logging in to the Print Controller” [p.8](#).

## How to Log In

---

For login procedures for the print controller, see “Logging in to the Print Controller (General user / Administrator)” [p.8](#).

### Important!:

- In the default settings, the login ID for the administrator is set to “Admin” without a password. Be sure to set a password after the logging in as the administrator. [p.48](#)

## Available functions for administrator

---

After logging in as the administrator, in addition to the available functions for general users, the following operations are enabled.

- Changing the detailed setting of the print controller [p.45](#)  
Configuring the network settings, user management, job management, date/time, touch panel settings, etc.
- Setting how job processing is distributed over the network by the print controller [p.54](#)
- Operation of queues (Create, Edit, Delete, Stop / Resume) [p.69](#)
- Viewing and saving the accounting (history) data [p.66](#)
- Viewing and saving system event information [p.68](#)
- Changing the settings of\*1, copying, moving and viewing\*2 jobs owned by other users. [p.15](#), [p.16](#), [p.19](#)
- Rebooting / Shutting down the print controller [p.75](#)

\*1 The secure print setting cannot be changed.

\*2 Jobs for which secure print has been set cannot be viewed.

# Detailed Settings of the Print Controller

This section describes how to make network settings, time settings, change the login password to the administrator setting, etc for the print controller.

The detailed setting screen for the print controller can be displayed by moving the mouse pointer over the **[RIP]** menu button and then clicking **[RIP details...]** in the displayed submenu.

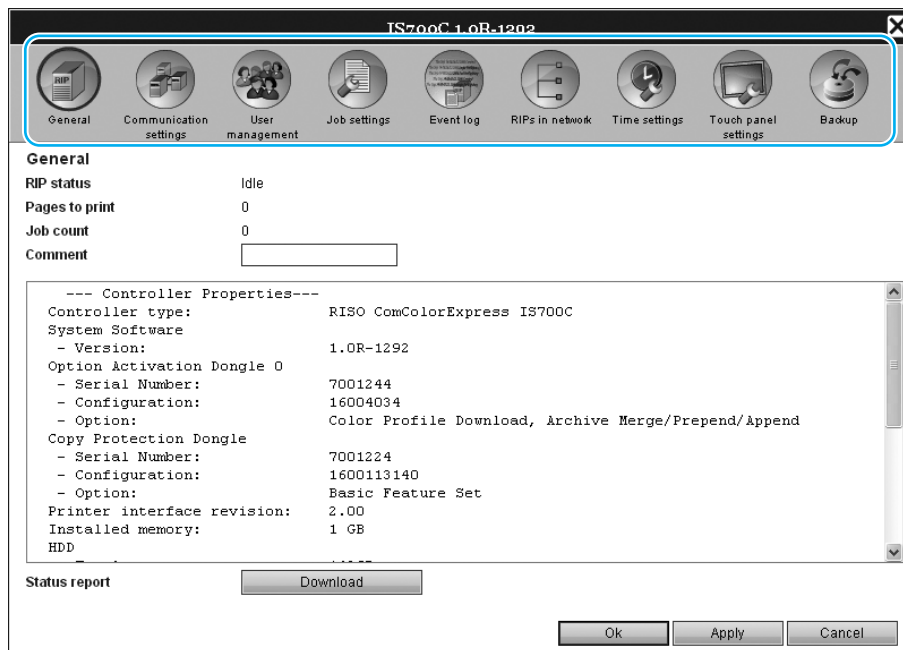

Clicking the icons at the top of the screen switches to the corresponding setting screen.

**[OK]**: Click to save setting changes and end editing.

**[Apply]**: Click to save setting changes and continue editing.

**[Cancel]**: Click to cancel setting changes and end editing.

# General

Displays the status and detailed information of the print controller.

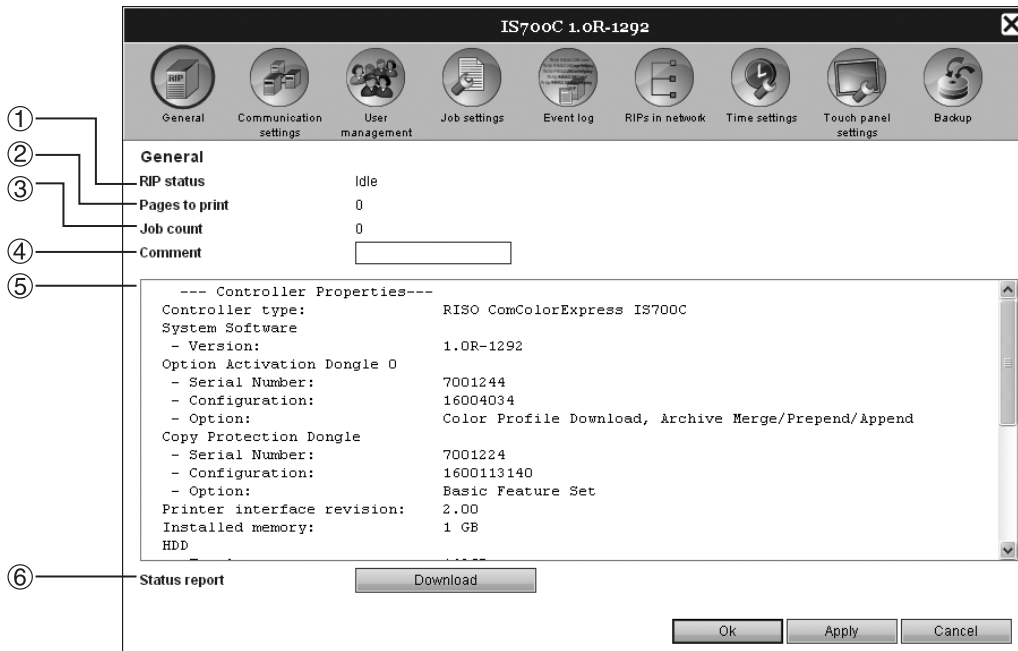

## Displayed information

### 1) RIP status

Displays the current status of the print controller.

### 2) Pages to print

Displays the total number of pages of jobs in the Normal queue (the number of pages of each job x the number of copies).

**Note:**

- Jobs in the Hold queue and jobs in stopped processing status are not included.

### 3) Job count

Displays the number of jobs in the Normal queue.

**Note:**

- Jobs in the Hold queue and jobs in stopped processing status are not included.

### 4) Comment

The comment concerning the print controller can be entered.

### 5) Detailed information

Displays an outline and network settings of the print controller.

### 6) Status report

The detailed information of the print controller can be downloaded in text format.

## Actions

- Inputting comments  
When you click the input area, a comment can be entered. Up to 255 characters can be entered. Comments should be written in one line.
- Downloading status report  
When you click the **[Download]** button and specify the destination folder and file name, the detailed information of the print controller is saved in text format.



## Network settings

The current network settings of the print controller are displayed under **[Current settings]**.

To change a setting, enter the new setting under **[After restart]**. The changed settings are applied after the print controller is restarted.

	Current settings	After restart
1) RIP name	IS700C	IS700C
2) Domain		
3) Use DHCP	<input type="checkbox"/>	<input type="checkbox"/>
4) IP address	192.168.9.51	192.168.9.51
5) IP gateway	192.168.9.254	192.168.9.254
6) Subnet mask	255.255.255.0	255.255.255.0
7) EtherTalk zone	*	*
8) NetBIOS workgroup	WORKGROUP	WORKGROUP
9) Name server	0.0.0.0	0.0.0.0
10) Mail server		
11) Sender address		
12) Proxy address		
13) Proxy port	3128	3128
14) Ethernet address	00:30:13:63:BE:19	
15) Enforce https	<input type="checkbox"/>	

### Settings

#### 1) RIP name

Enter the print controller name using only alphanumeric characters and hyphens within 63 characters. The entered name is displayed as the printer name on the network.

#### Note:

- Enter an alphabetic character as the first digit in the name.
- Enter an alphabetic character or numeric character as the last digit in the name.

#### 2) Domain

Enter the domain name of the network to which the printer is connected.

#### 3) Use DHCP

Place a checkmark to use the DHCP Server to acquire IP addresses.

#### 4) IP address

Enter the IP address being assigned to the print controller.

#### 5) IP gateway

Enter the gateway address of the network to which the print controller is connected.

#### 6) Subnet mask

Enter the subnet mask of the network to which the controller is connected.

#### 7) Ether Talk zone

When using the printer via AppleTalk, enter the AppleTalk zone name of the network to which the print controller is connected.

"\*" indicates that the print controller is enabled for all zones.

#### 8) NetBIOS workgroup

When the communications are conducted using NetBIOS, enter the NetBIOS workgroup name.

#### 9) Name server

If you are using a DNS server to connect to the network, enter the IP address of the DNS server.

#### 10) Mail server

To use e-mail notification, enter the IP address of the mail server.

#### 11) Sender address

To use e-mail notification, enter the e-mail address of the source.

#### 12) Proxy address

Enter the IP address of the proxy server.

#### 13) Proxy port

Enter the port of the proxy server.

#### 14) Ethernet address

Displays the Ethernet address of the print controller.

#### 15) Enforce https

Place a checkmark to connect the print controller by https (encrypted communication) when using the RISO Console. When a checkmark is placed, the screen automatically jumps to https:// (IP address of the controller) even if you connect to the print controller by http:// (IP address of the controller).

When displaying the screen, a dialog box concerning security warning (authentication verification) is displayed. Click the **[Yes]** button to continue.

# User management

You can configure the settings for managing the users of the print controller.

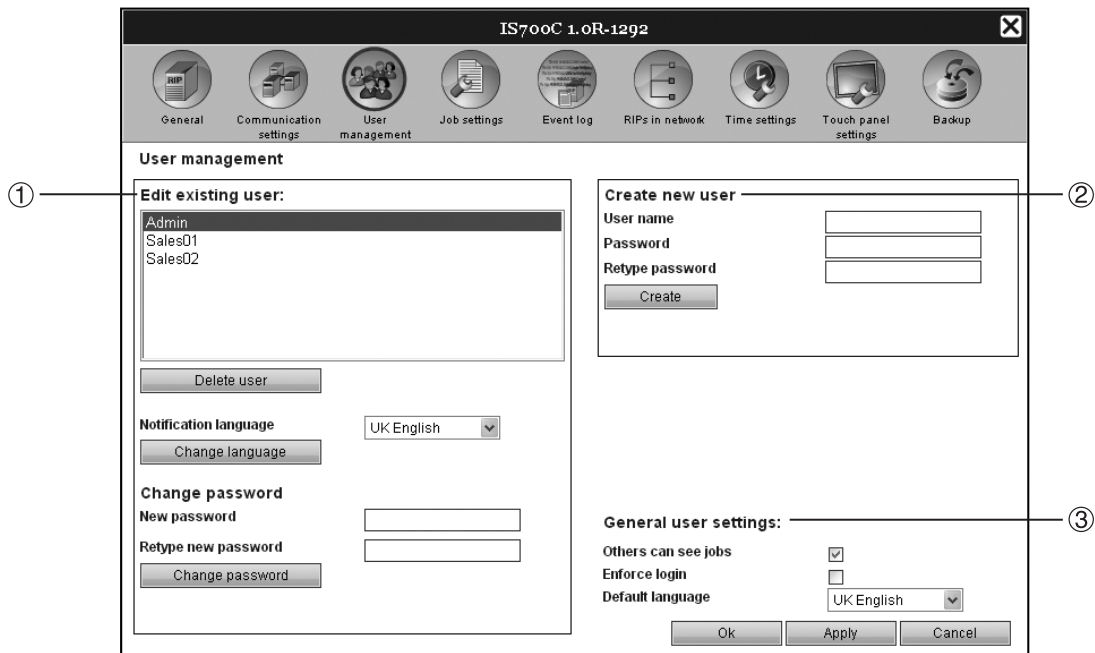

## Settings

### 1) Edit existing user

Registered user names are displayed in the list box. You can delete users, and change the language and passwords.

### 2) Create new user

Register the user by entering the user name and the password.

### 3) General user settings

**[Other can see jobs]:** Enables/Disables access to jobs of different owner.

**[Enforce login]:** Sets whether the login is enforced or not when using the Touch Panel Display and the RISO Console.

**[Default language]:** Sets the language to be used when an unregistered user uses the notification function.

## Deleting Registered Users

- 1) Select the user name to delete from the list of the names of registered users.
- 2) Click the **[Delete user]** button.  
The user is deleted.

## Changing the Language of Notifications

- 1) Select the user name from the list of the names of registered users.
- 2) Select a language from the **[Notification language]** combo box.
- 3) Click the **[Change password]** button.  
Set the language to be used for notification functions such as e-mail notifications to selected users.

## Changing Passwords

- 1) Select the user name to which the password will be changed from the list of the names of registered users.
- 2) Enter the new password in the **[New password]** input area.  
Enter a password in 0 to 31 characters using alphanumeric characters and symbols (!"#\$%&'()\*+,-./:;<=>?@[^\_`{|}~).
- 3) Re-enter the new password in **[Retype new password]** the input area.
- 4) Click the **[Change password]** button.  
The password is changed.

### Note:

- When the entry for **[New password]** does not correspond to that for **[Retype new password]**, an error message is displayed. Enter the same password again.

## Registering New Users

- 1) Enter the new user name in the **[User name]** input area.  
As the user name, enter the name used when logging into the network. (Refer to the names displayed as owner names in the job list)
- 2) Enter the password in the **[Password]** input area.  
Enter the password in 0 to 31 characters using alphanumeric characters and symbols (!"#\$\$%&'()\*+,-./:;<=>@[^\_`{|}~).
- 3) Re-enter the password in the **[Retype new password]** input area.
- 4) Click the **[Create]** button.  
The user is registered, and the user name is added to the list of registered user names on the left side of the screen.

## Changing General User Settings

- When a checkmark is placed in the **[Others can see jobs]**, access to jobs of different owners is enabled.
- When a checkmark is placed in the **[Enforce login]**, entry by login ID and password is enforced in using the Touch Panel Display and the RISO Console.  
When **[Enforce login]** is set, only the login information input area and some operations can be used. (The operations that cannot be used are greyed out.)
- From the **[Default language]** combo box, select the language to be used when a notification function is used by an unregistered user.

## Job settings

This screen is for making settings concerning job processing by the print controller.

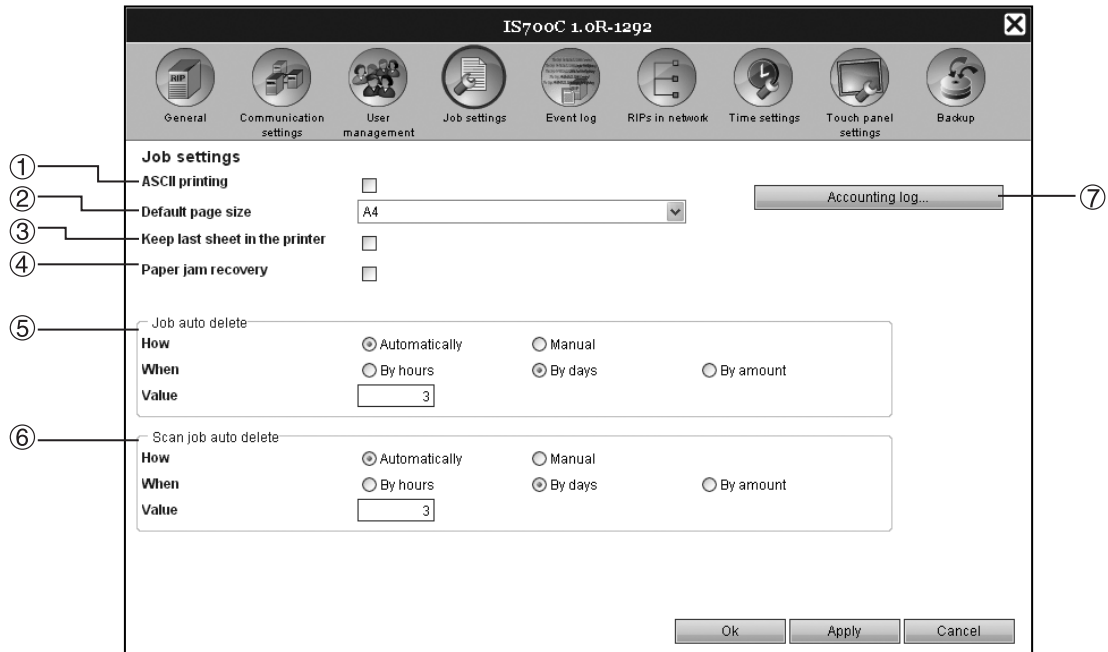

### Settings

- 1) **ASCII printing**  
Enables/Disables printing of ASCII text jobs.
- 2) **Default page size**  
Sets the page size applied to the jobs for which a page size has not been set.
- 3) **Keep last sheet in the printer**  
Sets whether or not the data of the last sheet should be saved in the printer.
- 4) **Paper jam recovery**  
Place a checkmark to reprint jobs in the case that a paper jam occurs in the finisher when the finisher is connected to the printer.
- 5) **Job auto delete**  
Sets the deletion method and timing for print jobs stored in the print controller.
- 6) **Scan job auto delete**  
Sets the deletion method and timing for scanned jobs stored in the print controller.
- 7) **Accounting log... (Only for administrator login)**  
The history concerning job processing in the print controller can be checked.

### ASCII File Print Settings [ASCII printing]

When placing a checkmark in the **[ASCII printing]**, ASCII text jobs can be printed. When a job of unknown file format has been received, the job is printed in ASCII text.

#### Note:

- When **[ASCII printing]** is enabled, all jobs except for PostScript, PCL, PDF, and TIFF files are printed in ASCII text.

### Setting Default Page Size [Default page size]

From the **[Default page size]** combo box, select the page size applied to jobs for which a page size has not been set.

#### Note:

- Jobs for which a page size has not been set are, for example, sample pages stored in the print controller and print jobs created by printer drivers except the printer driver of this print controller.

## Keeping the data printed at the last in the printer [Keep last sheet in the printer]

Set whether or not the data of the last sheet of the previous job should be kept in the printer after the printing until the printing of next job.

When placing a checkmark, the “Menu 3 Load Kept Data” in the menu setting of the printer can be used.

### Note:

- When [**Secure print**] is set by the printer driver, the data is not kept in the printer. For details, refer to the separate manual, “ComColorExpress IS700C Printer Driver Guide.”

## Reprinting if a jam occurs in the finisher [Paper jam recovery]

Place a checkmark to reprint jobs by resending the data from the print controller if a paper jam occurs in the finisher connected to the printer.

## Setting the deletion method of print jobs [Job auto delete]

Set whether to delete the print jobs stored in the print controller automatically or manually.

- 1) Select [**Automatically**] or [**Manual**] in [**How**] of [**Job auto delete**].  
When [**Automatically**] is selected, proceed to step 2. When [**Manual**] is selected, other settings are not required.
- 2) Select the unit of deletion timing in [**When**].  
[**By hours**]: When the set time elapses, jobs are automatically deleted.  
[**By days**]: When the set number of days elapses, jobs are automatically deleted.  
[**By amount**]: When the number of stored jobs exceeds the set number, jobs are automatically deleted in chronological order with the oldest job deleted first.
- 3) Enter the reference number in the [**Value**] input area.  
The timing of automatic deletion is decided in conjunction with the unit selected in step 2.

## Setting the Deletion Method of Scan Jobs [Scan job auto delete]

Set whether to delete the scan jobs stored in the print controller automatically or manually.

When [**Automatically**] is selected, set the deletion timing.

- 1) Select [**Automatically**] or [**Manual**] in [**How**] of [**Scan Job auto delete**].  
When [**Automatically**] is selected, proceed to step 2. When [**Manual**] is selected, other settings are not required.
- 2) Select the unit of deletion timing in [**When**].  
[**By hours**]: When the set time elapses, jobs are automatically deleted.  
[**By days**]: When the set number of days elapses, jobs are automatically deleted.  
[**By amount**]: When the number of stored jobs exceeds the set number, jobs are automatically deleted in chronological order with the oldest job deleted first.
- 3) Enter the reference number in the [**Value**] input area.  
The timing of automatic deletion is decided in conjunction with the unit selected in step 2.

## Checking Account Information [Accounting log...] (Only for administrator login)

A history of job processing by the print controller can be checked. When clicking the [**Accounting log...**] button, the accounting information screen is displayed.

For details, see “Check Account Information”. [p.66](#)

## Event log

This screen is for making settings for events that occur with the print controller.

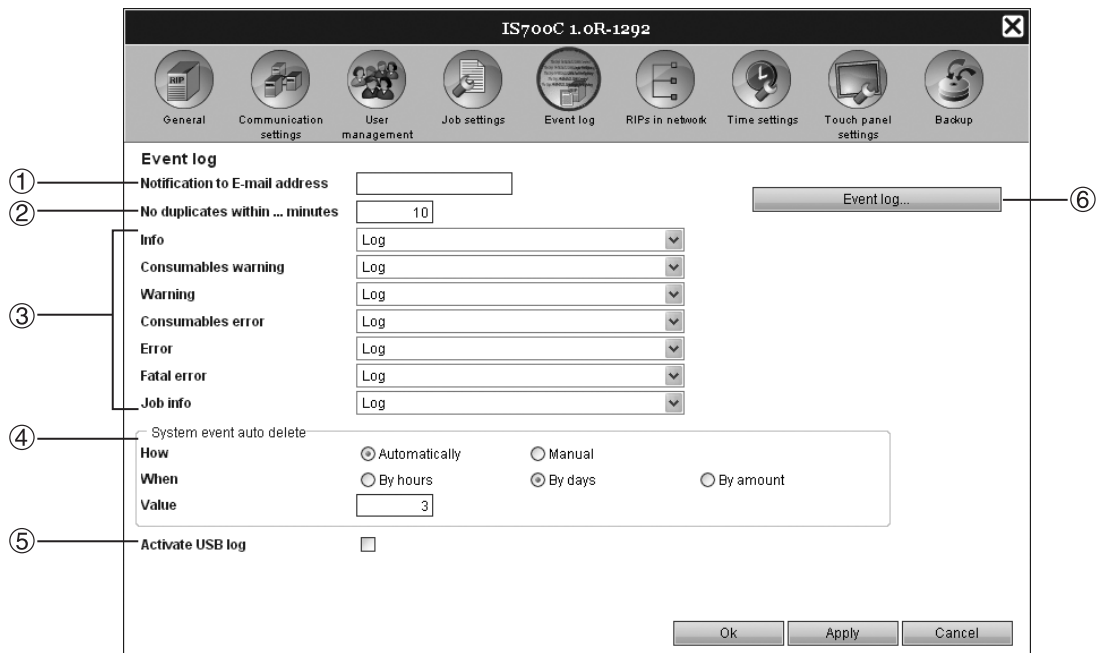

### Settings

#### 1) Notification to E-mail address

Enter the e-mail address to notify event information of the print controller.

#### 2) No duplicates within...minutes

Sets not to notify the same event if it occurs within the set amount of time.

#### 3) Event information notification method

(The method can be set according to the type of event.)

- Info
- Consumables warning
- Warning
- Consumables error
- Error
- Fatal error
- Job info

#### 4) System event auto delete

Sets the deletion method and timing for event information stored in the print controller.

#### 5) Active USB log

Sets whether or not to store the information exchanged between the print controller and the printer via USB into the memory.

#### 6) Event log...

A history of event information of the print controller can be checked. The history can be downloaded as a file in CSV format.

### Setting the Destination of E-mail Notification [Notification to E-mail address]

In the [Notification to E-mail address] input area, enter the e-mail address to notify event information to. When e-mail is not used for notification, entry into the input area is not required.

### Preventing duplicated notification of the same event [No duplicates within...minutes]

Enter the number (minute) in the [No duplicates within...minutes] input area. The same event that occurs within the set amount time is set to be not notified.

If the same event occurs repeatedly in a short period of time, such as the case that the cover of the printer is frequently opened and closed to clear paper jams, this setting prevents repeated recording of events of the same content and e-mail notification.

- The time can be entered in a range from 0 to 1,440 minutes (the default value is 10 minutes).

## Setting the Notification Method of Event Information

Set the notification method according to the type of event. Select the notification method in the combo box of each item.

- Type of event
  - [Info]**: Information concerning the boot of the print controller, and the start and end of processing
  - [Consumables warning]**: When there is little paper or ink remaining
  - [Warning]**: When there is little space on the hard disk
  - [Consumables error]**: When there is no paper or ink left
  - [Error]**: When there is no space left on the hard disk
  - [Fatal error]**: When a serious system failure has occurred
  - [Job info]**: Information concerning the processing of job
- Notification method
  - [None]**: Does not record the event.
  - [Log]**: Records the event.
  - [Log and mail]**: Records the event and sends e-mail notification to the set destination e-mail address.
  - [Mail]**: Sends e-mail notification to the set destination e-mail address.

## Setting the Deletion Method of Event Log [System event auto delete]

Set whether event information stored in the print controller is deleted automatically or manually.

When **[Automatically]** is selected, set the deletion timing.

- 1) Select **[Automatically]** or **[Manual]** in **[How]** of **[System event auto delete]**.  
When **[Automatically]** is selected, proceed to step 2. When **[Manual]** is selected, other settings are not required.
- 2) Select the unit of deletion timing in **[When]**.
  - [By hours]**: When the set time elapses, jobs are automatically deleted.
  - [By days]**: When the set number of days elapses, jobs are automatically deleted.
  - [By amount]**: When the number of stored event information exceeds the set number, jobs are automatically deleted in chronological order with the oldest job deleted first.
- 3) Enter the reference number in the **[Value]** input area.  
The timing of automatic deletion is decided in conjunction with the unit selected in step 2.

## Enabling the Acquisition of the USB Log [Active USB log]

When placing a checkmark in the **[Active USB log]**, the information (excluding job data) exchanged between the print controller and the printer in USB communications is recorded.

### Note:

- The recorded information is used only for servicing.
- Do not place a checkmark when the acquisition of the event log is not required.

## Checking the Event Log [Event log...]

A history of event information in the Print Controller can be checked.

When you click the **[Event log...]** button, the system event log screen is displayed.

For details, see "Checking the System Events Log". [p.68](#)

## RIPs in network

To use the job delegation, the print controllers are set for load balancing.

### Job delegation

Job delegation is the load distribution function for print processing. When several print controllers of the same type are installed in the network, jobs are delegated to these print controllers for processing.

**Note:**

- Only the IS700C can be specified as the print controller for load balancing. Load balancing with other models and non-RISO print controllers is not possible.
- The system for load balancing can consist of one master controller and one or more client controller. The load balancing settings are made by the master controller. No settings are required on the client controller side.

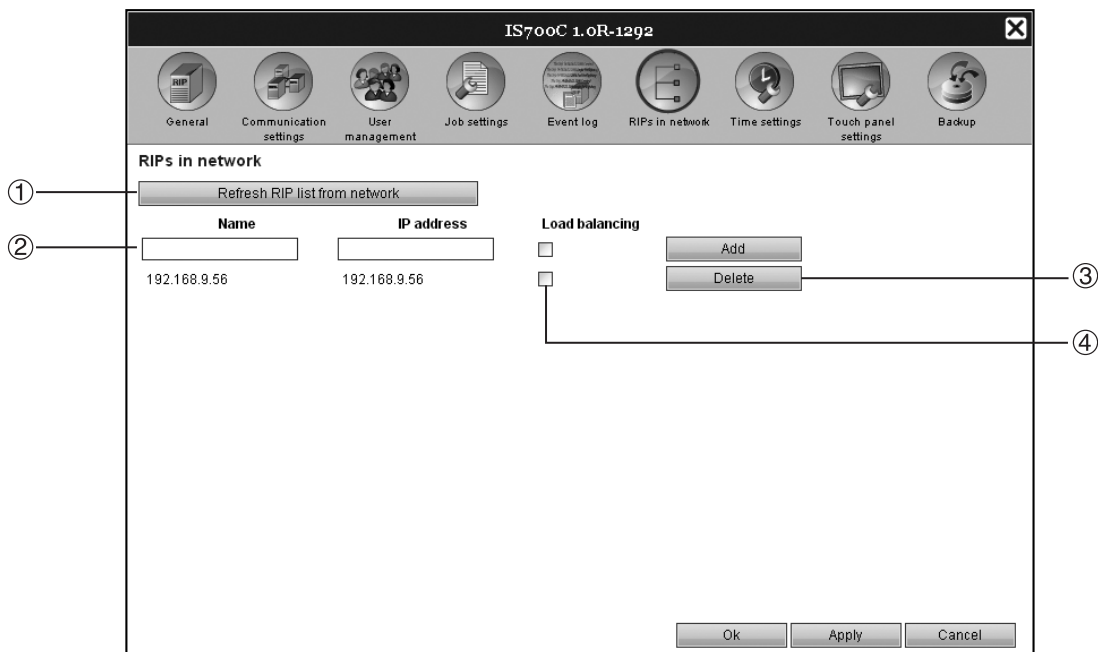

**Actions**

- |  |  |
|--|--|
| <p><b>1) Refresh RIP list from network</b><br/>Searches for IS700C connected to the network.</p> <p><b>2) Direct input and addition of Name / IP address</b><br/>Adds the name and IP address of the print controller to the list by direct input.</p> | <p><b>3) Deletion from the controller list</b><br/>Deletes the print controllers from the list.</p> <p><b>4) Job delegation setting (Load balancing)</b><br/>Sets whether or not the print controller in the list is used for distributed processing (for load balancing).</p> |
|--|--|

**Searching for Print Controllers on the network [Refresh RIP list from network]**

When clicking the [Refresh RIP list from network] button, the IS700C connected to the network is searched and the list with the latest information is updated.

**Direct input and addition of Name / IP address [Name][IP address][Add]**

Add the name and IP address of the print controller to the list by direct input.

**[Name]:** Enter the RIP name.

**[IP address]:** Enter the IP address of the print controller.

**[Add]:** The name and IP address are added to the list.



## Job delegation setting [Load blancing]

When placing a checkmark in the checkbox on the right side of Name / IP address of the print controller, the print controller can be used for load balancing (load distribution processing).

## Deleting from the controller list [Delete]

When clicking the **[Delete]** button on the right side of Name / IP address of the print controller, the print controller is deleted from the list.

## Time settings

Synchronizes the print controllers' time settings with the computer's time settings.



### Displayed information

#### 1) PC time

Displays time settings of the computer.

#### 2) RIP time

Displays time settings of the print controller.

### Actions

#### • [Synchronize]

When clicking the button, the print controller's time settings will be synchronized with the computer's time settings.

#### Note:

- Time zone settings are also synchronized with the settings of the computer.

# Touch panel settings

This screen is for making settings concerning the optional Touch Panel Display.

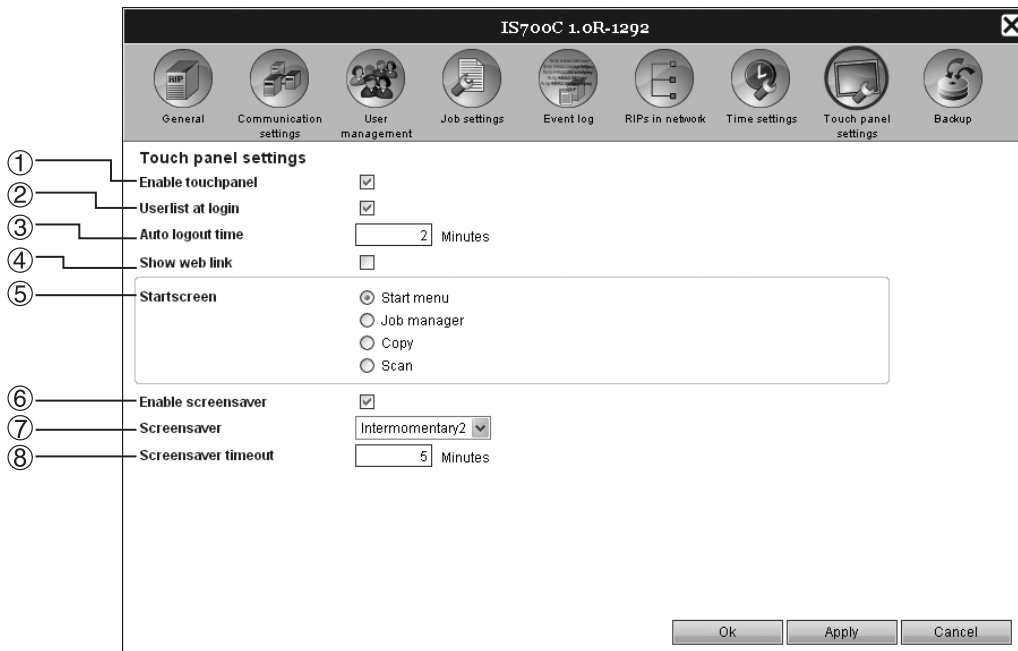

## Settings

- 1) Enable touchpanel**  
Sets whether or not you use the Touch Panel Display. When you do not use the Touch Panel Display, remove the checkmark.
- 2) Userlist at login**  
When placing a checkmark, the list of registered users is displayed on the Touch Panel Display in logging in.
- 3) Auto logout time**  
Sets the time for automatic logout when the Touch Panel Display is unused for an extended period of time.
- 4) Show web link**  
Sets whether or not the link to websites (websites for ordering consumables, etc.) should be displayed on the start menu.
- 5) Startscreen**  
Select the screen to be displayed when the Touch Panel Display starts.
- 6) Enable screensaver**  
Sets whether or not to use the screensaver.
- 7) Screensaver (selection)**  
Select the screensaver to use.
- 8) Screensaver (start time)**  
Sets the time (minute) that the screensaver starts when the Touch Panel Display is unused for an extended period of time.

## Enabling the Touch Panel Display [Touch panel settings]

When the Touch Panel Display is connected, place a checkmark in the [Touch panel settings]. When the Touch Panel Display is not connected, remove the checkmark.

## Enabling the list of login IDs on the Touch Panel Display [Userlist at login]

When placing a checkmark, the login ID of users registered by the print controller is displayed as the user list. On the Touch Panel Display, select a login ID from the user list to log in.

## Setting the auto logout time [Auto logout time]

Sets the time for automatic logout when the Touch Panel Display is unused for an extended period of time.

- The time can be entered in the range from 1 to 99 minutes (the default value is 2 minutes).

## Show Web Link [Show web link]

When placing a checkmark in the **[Show web link]**, link buttons to websites (websites for ordering consumables, etc.) are displayed on the start menu on the Touch Panel Display.

## Setting the startup screen [Startscreen]

Sets the screen to be displayed when the Touch Panel Display starts to either one of the following.

- Start menu / Job manager / Copy / Scan

### Note:

- Copy and Scan can only be set when the optional scanner is connected.

## Setting up the Screensaver

Sets whether or not to use the screensaver when the Touch Panel Display is unused for an extended period of time.

- Enable screen saver  
Place a checkmark in the **[Enable screensaver]** when using the screensaver.
- Screensaver (selection)  
The screensaver can be selected from the list of usable screensavers.
- Screensaver (start time)  
Sets the time at which the screensaver starts.  
The time can be entered in a range from 1 to 9,999 minutes (the initial value is 5 minutes).

## Backup

This screen is for exporting various settings of the print controller to the computer and importing settings from the computer.



### Settings

#### 1) Backup Queues

Settings of the queues can be exported to or imported from the computer.

#### 2) Backup Users

The login setting of users set in **[User management]** can be exported to or imported from the computer.

#### 3) Backup of multiple archived jobs

All archived jobs saved in the print controller can be exported to or imported from the computer.

### Exporting queue settings to the computer [Export Queues]

Click the **[Export Queues]** button, and enter the destination folder and file name, and then execute the save. All the queue settings currently registered in the print controller are saved. The file is saved in text format.

### Importing queue settings from the computer [Restore Queues]

Click the **[Browse]** button, and specify the queue setting file to import (in text format). Click the **[RestoreQueues]** button, and execute the import to the print controller.

#### Note:

- The imported queue is added to the existing queues in the print controller.
- When there is the same queue name as the imported queue in the print controller, the existing queue will be overwritten with the information of the imported queue.

### **Exporting user login settings to the computer [Export Users]**

Click the **[Export Users]** button, enter the destination folder and file name, and then execute the save.

All the user login settings currently registered in the print controller are saved (excluding the settings of the administrator).

The file is saved in text format.

**Note:**

- Passwords are saved after being encrypted.

### **Importing user login settings from the computer [Restore Users]**

Click the **[Browse]** button, and specify the login setting file to import (in text format). Click the **[Restore Users]** button, and execute the import to the print controller.

**Note:**

- When the settings of the same user exists in the print controller, the existing settings will be overwritten with the settings imported.

### **Exporting multiple archived jobs to the computer [Export archive jobs]**

Click the **[Export archive jobs]** button, enter the destination folder and file name, and then execute the save.

All archived jobs currently saved in the print controller are saved in one file.

The file is saved with a .shae extension.

**Note:**

- Archived jobs can be also individually saved.  
“Download Archive jobs”  p.37
- Files can be saved up to 2 GB in size.

### **Importing multiple archived jobs from the computer [Import archive jobs]**

Click the **[Browse]** button, and specify the archived jobs file to import. (The extension is .shae.) Click the **[Import archive jobs]** button to import to the print controller.

**Note:**

- The imported archived jobs are added to the list of archived jobs.

# Customization Settings

Frequently used form data, user defined paper size, and PCL tray setting can be registered in the print controller in advance.

The customization setting screen can be displayed by moving the mouse pointer over the **[RIP]** menu button and then clicking **[Custom preferences...]** in the displayed submenu.

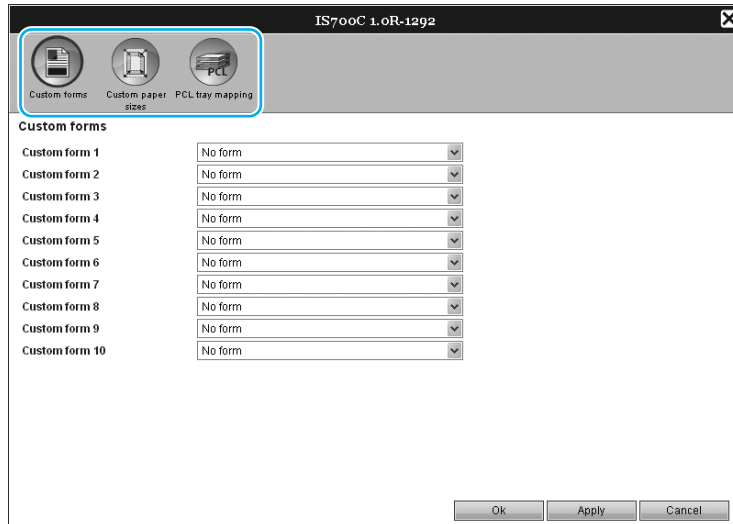

When you click the icons at the top of the screen, the screen will switch to corresponding setting screens.

**[OK]**: Click to save setting changes and end editing.

**[Apply]**: Click to save setting changes and continue editing.

**[Cancel]**: Click to cancel setting changes and end editing.

## Custom forms

Register the frequently used form data.

The custom forms registered here are displayed by the combo boxes - **[Form 1 (all pages or front)]**,

**[Form 2(back)]**, **[Prepend job]**, and **[Append]** - on the **[Forms]** screen of the **[Job details]** menu.

"**[Form]** screen" [p.27](#)

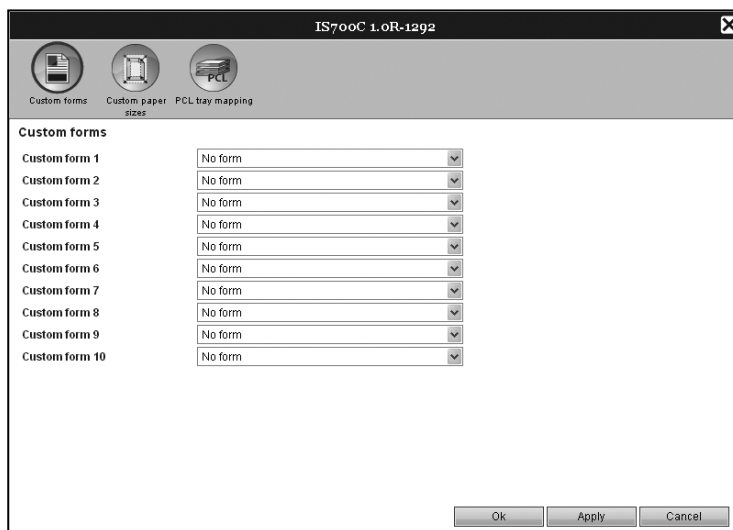

### Settings

- Custom form 1 to 10  
Archived jobs saved in the print controller are allocated to custom forms.

## Setting up custom forms

In the combo box of the custom form you want to set, select the name of the archived job to allocate.

Custom forms	
Custom form 1	Letterhead_002.pdf
Custom form 2	Letterhead_004.pdf
Custom form 3	No form
Custom form 4	No form
Custom form 5	document_001.doc
Custom form 6	document_002.doc
Custom form 7	document_003.doc
Custom form 8	Letterhead_001.pdf
Custom form 9	Letterhead_002.pdf
Custom form 10	Letterhead_003.pdf

## Custom paper sizes

Registers irregular paper sizes.

The paper sizes registered here are displayed in the **[Output size]** combo box in the **[Layout]** screen of the **[Job details]** menu.

“**[Layout]** screen” p.22

The paper sizes are also applied to the paper settings on the printer driver side. For details, refer to the separate manual, “ComColorExpress IS700C Printer Driver Guide.”

Name	Width in mm	Height in mm
Custom1	0	0
Custom2	0	0
Custom3	0	0
Custom4	0	0
Custom5	0	0
Custom6	0	0
Custom7	0	0
Custom8	0	0
Custom9	0	0
Custom10	0	0

### Settings

- Custom 1 - 10  
Registers the **[Width in mm]** and **[Height in mm]** to the paper names.

### Setting custom paper sizes (user defined sizes)

Enter a numeric value (mm) in the **[Width in mm]** box and the **[Height in mm]** box on the right side of the paper name.

#### Note:

- Set the custom paper sizes within the range of paper sizes that can be used by the printer. For details, see the “Printer’s User’s manual.”
- When an optional HC Finisher and HC Auto Stacker are connected, usable paper sizes differ depending on the finisher functions. For details, see “HC Finisher Maintenance Guide”, “Printer’s User’s manual.”

## PCL tray setting

---

Set the allocation of trays to be used when processing PCL jobs.



### Actions

Assign the tray number specified in the PCL job to a tray of the printer.

### Setting tray allocation for PCL jobs

Enter the tray numbers in the PCL job as the printer trays: **[Standard tray]**, **[for Tray 1]**, and **[Tray 2]**.

### Note:

- When entering multiple tray numbers in the **[Tray numbers in PCL job]** box, separate the numbers by commas (,).



# Colour Calibration

Colour calibration information can be exported to or imported from the computer.

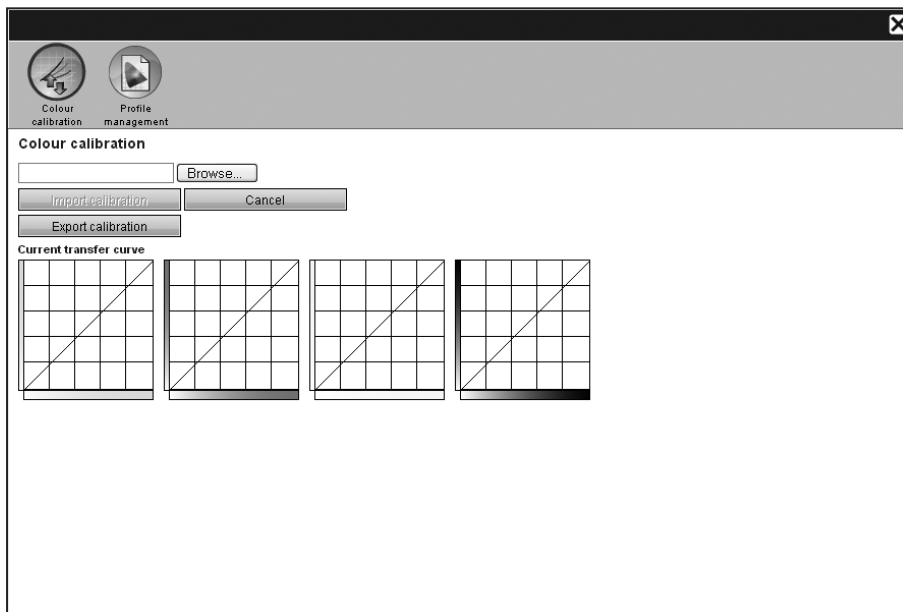

## Exporting the colour calibration information to the computer [Export calibration]

Click the **[Export calibration]** button, enter the destination folder and file name, and then execute the save. The file is saved in text format.

## Importing colour calibration information from the computer [Import calibration]

Click the **[Browse]** button, and specify the colour calibration information file to import (in text format). Click the **[Import calibration]** button to import to the print controller.

### Note:

- The existing colour calibration information will be overwritten with the imported information.

When finished checking, click  to close the screen.

# Profile management

Profiles used in colour management settings can be added / deleted.  
For colour management settings, see “[Colour] screen”. p.26

**Note:**

- The optional “IS700C Advanced Package” or “IS700C Professional Package” is required for using this function.

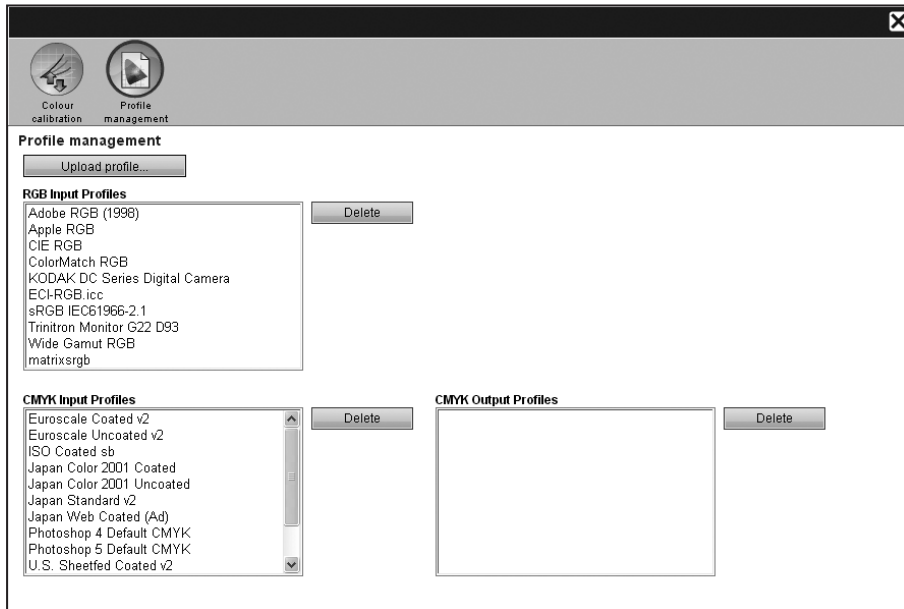

## Deleting profiles [Delete]

Select the name of the profile to delete from the profile list, and click the [Delete] button.

**Note:**

- The preinstalled profiles cannot be deleted.

## Uploading profiles [Upload profile]

**1** Click the [Upload profile] button.

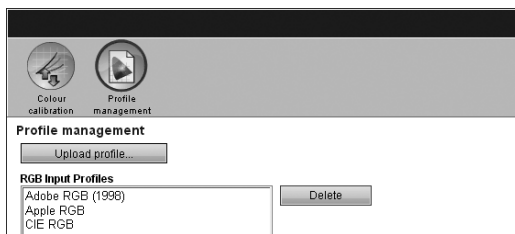

The following screen is displayed.

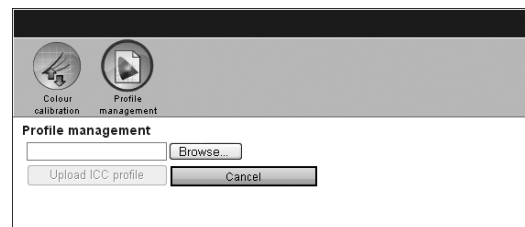

- 2** Click the [Browse] button.
- 3** Specify the profile to import. (The extension is .icc.)

#### 4 Click [Upload ICC profile].

The following screen is displayed.

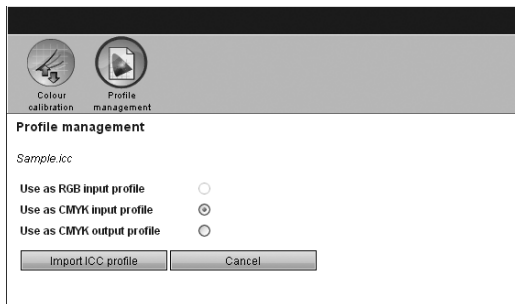

#### 5 Select the use of the profile using the radio buttons.

#### 6 Click the [Import ICC profile] button.

The profile is imported to the print controller, and the profile name is added to the profile list.

#### 7 When the operation is completed, click to close the screen.

# Checking Account Information

A history of job processing performed by the print controller can be checked.

- 1 Move the mouse pointer over the [RIP] menu button and then click [Accounting info] in the displayed submenu.

The accounting information screen is displayed.

**Note:**

- The accounting information screen can be also displayed by clicking the [Accounting info] button under [Job settings] on the RIP details screen.

Job	Owner name	Date/Time reception	Processing time	Print time	Page count	Output count	Final status
PCL Font Sample Page		9.03.2007 16:53:45	4	0	3	1	Normal
Document_002.doc	Sales01	10.03.2007 16:03:46	20	0	18	1	Normal
document_003.doc	Sales02	10.03.2007 16:05:37	19	0	18	1	Normal
Document_002.doc	Sales01	10.03.2007 20:56:34	5	22	18	1	Normal
Document_002.doc	Sales01	10.03.2007 20:57:09	10	22	18	1	Normal
Document-001.pdf	Admin	10.03.2007 22:32:36	13	16	11	1	Normal
Letterhead_004.pdf	Sales03	10.03.2007 22:35:31	15	0	11	1	Normal
Letterhead_002.pdf	Sales03	10.03.2007 22:43:15	10	8	11	1	Aborted
Document-001.pdf	Admin	11.03.2007 11:44:23	7	0	11	1	Normal

Download accounting logfile

A list of job processing up until this time is displayed.

- Displayed items: Job, Owner name, Date/Time reception, Processing time, Print time, Page count, Output count, Final status
- When you click an entry in the list, the [Remove selected entry] button, the [Remove all older entries] button, and the [Show details] button are displayed.

		11:52:38					
Document_002.doc	Sales01	2.04.2007 21:13:03	2	0	18	1	Error
Letterhead_002.pdf	Sales02	28.03.2007 13:56:48	0	0	1	1	Normal
<b>Document_001.pdf</b>	<b>Admin</b>	<b>8.04.2007 12:56:57</b>	<b>2</b>	<b>0</b>	<b>2</b>	<b>1</b>	<b>Normal</b>
SeminorReport.pdf	Admin	8.04.2007 12:57:54	2	0	4	1	Normal

Download accounting logfile

**[Remove selected entry]:** When clicked, the selected entry is removed.

**[Remove all older entries]:** When clicked, all information prior to the selected entry is removed.

**[Show details]:** When clicked, the screen switches to the details screen of the selected job. Click the **[Back to overview]** button to return to the list screen.

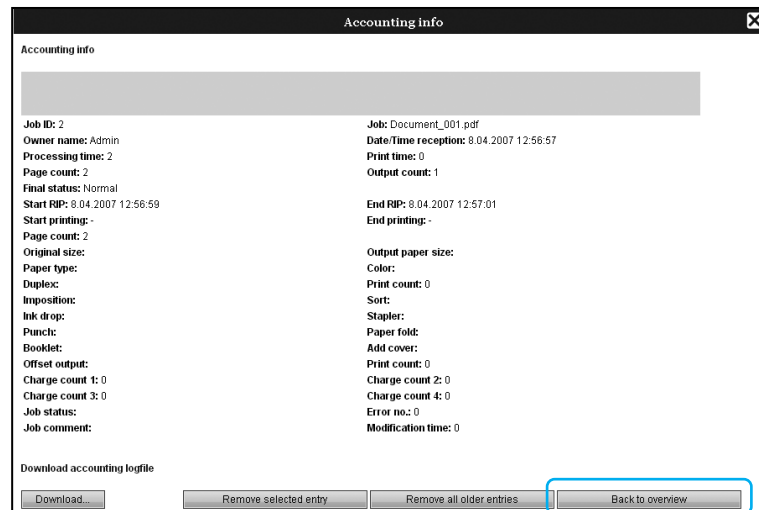

- To save the account information, click the **[Download]** button, and specify the destination folder and file name to save. The data is saved in CSV file format.

**2** When finished checking, click **[X]** to close the screen.

# Checking the System Events Log

A history of events (various kinds of processing) that occurred in the print controller can be checked.

- 1 Move the mouse pointer over the [RIP] menu button and then click [Event log] in the displayed submenu.

The system events log screen is displayed.

**Note:**

- The system events log screen can be also displayed by clicking the [Event log] in [Event log setting] on the RIP details screen.

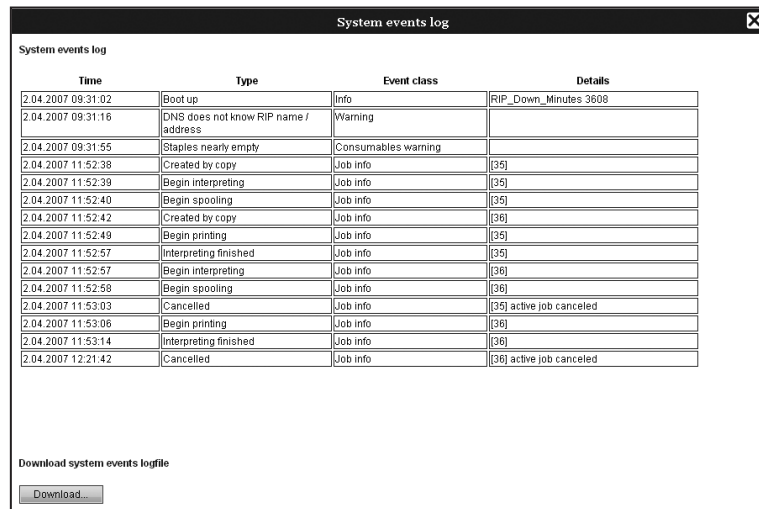

A list of events up until this time is displayed.

- Displayed items: Time, Type, Event class, Details
- To save the event log, click the [Download] button, and specify the destination folder and file name to save. The data is saved in CSV file format.
- When you click an event in the list, the [Remove all older entries] button is displayed.

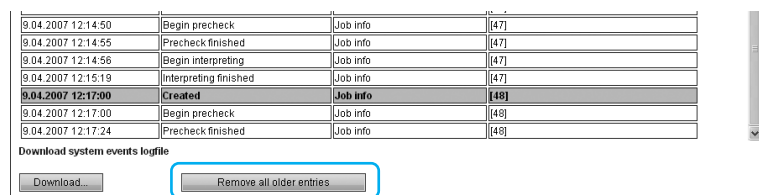

When you want to delete all old entries at once, click the [Remove all older entries] button to delete the event.

- 2 When finished checking, click to close the screen.

# Managing Custom Queue

The administrator can register various settings in the print controller in advance to process jobs sent from the computer as a custom queue. With the registration of frequently used print settings as a custom queue, you can print jobs with the same processing conditions without changing the settings many times, by simply specifying the registered output queue.

## Note:

- The processing items that can be set for queues are based on the setting items of the printer driver. [p.71](#)
- For instructions on how to specify the output queue, refer to the separate manual, “ComColorExpress IS700C Printer Driver Guide”.

## Creating New Queues [Create new queue]

- 1 Move the mouse pointer over the [Queue] menu button and then click [Create new queue] in the displayed submenu.

The new queue creation screen is displayed.

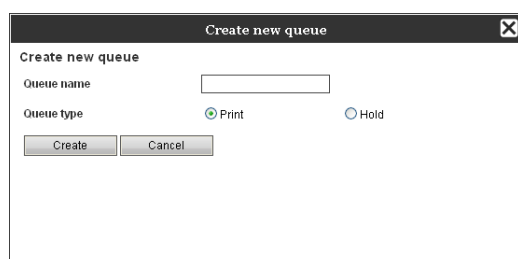

- 2 Enter the name of the new queue in the [Queue name] input area.

Enter a name up to 12 characters long using alphanumeric characters and symbols (!#\$@%&'()-.^\_{}~).

- 3 Select [Queue type].

**[Print]:** The job sent to this queue is printed by the printer.

**[Hold]:** The job sent to this queue is stored in the print controller and will not be printed until a print command is given.

- 4 Click the [Create] button.

The button of the queue name input in step 2 is added to the Job / Queue selection buttons (on the left side of the screen).

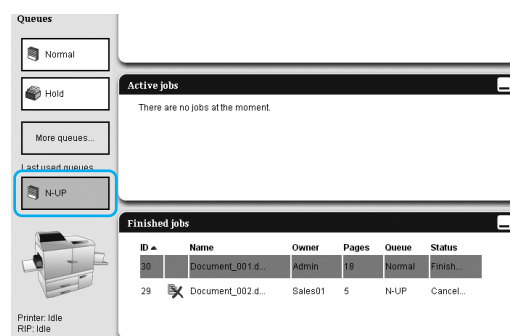

- 5 Set the processing conditions of the queue.

For processing conditions and setting method, see “Changing Detailed Settings of Queues”. [p.71](#)

## Deleting Custom Queues [Delete queue]

---

- 1 Click the queue button to delete from the Job / Queue selection buttons (on the left side of the screen).

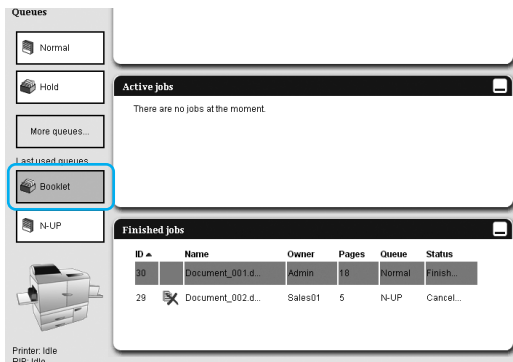

- 2 Move the mouse pointer over the [Queue] menu button and then click [Delete queue] in the displayed sub-menu.

**Note:**

- After selecting the queue button, the queue can be also deleted by clicking  of the Job / Queue information display (on the right side of the screen) in the state that the job is unselected.

- 3 Click the [OK] button in the confirmation dialog box.

The selected custom queue is deleted.

**Note:**

- [Normal] and [Hold] queues cannot be deleted.



## Changing Detailed Settings of Queues [Queue details...]

This section describes processing settings of newly created queues and how to change the settings of existing queues.

### Note:

- The following settings of **[Normal]** and **[Hold]** queues can be changed.
  - Normal queues: Password, priority, direct port, preferred PDL, prechecking setting
  - Hold queues: Password, prechecking setting

## 1 After selecting a queue button, click of the Job / Queue information display (on the right side of the screen) in the state that the job is unselected.

The queue details screen is displayed.

When you click the setting group icon at the top of the screen, the screen will switch.

### Note:

- The queue details screen can be also displayed by moving the mouse pointer over the **[Queue]** menu button and then clicking **[Queue details...]** in the displayed submenu.

Queue details screen (Edit screen)

## 2 Changing queue processing settings.

When you click the icon at the top of the screen, the screen will switch.

**[Queue priority]**: When placing a checkmark, the settings of queue are prioritized over the settings for the printer driver.

**[OK]**: Click to save setting changes and end editing.

**[Apply]**: Click to save setting changes and continue editing.

**[Cancel]**: Click to cancel setting changes and end editing.

The processing items that can be set for queues are the same as the setting items for jobs except **[General]** and **[PCL settings]**.

For the settings of the **[General]** screen and the **[PCL settings]** screen, see the next page onward.

For other screens, see "View / Edit the Details Setting of Jobs".  p.19

## [General] screen

The outline information and basic settings of queues are displayed.

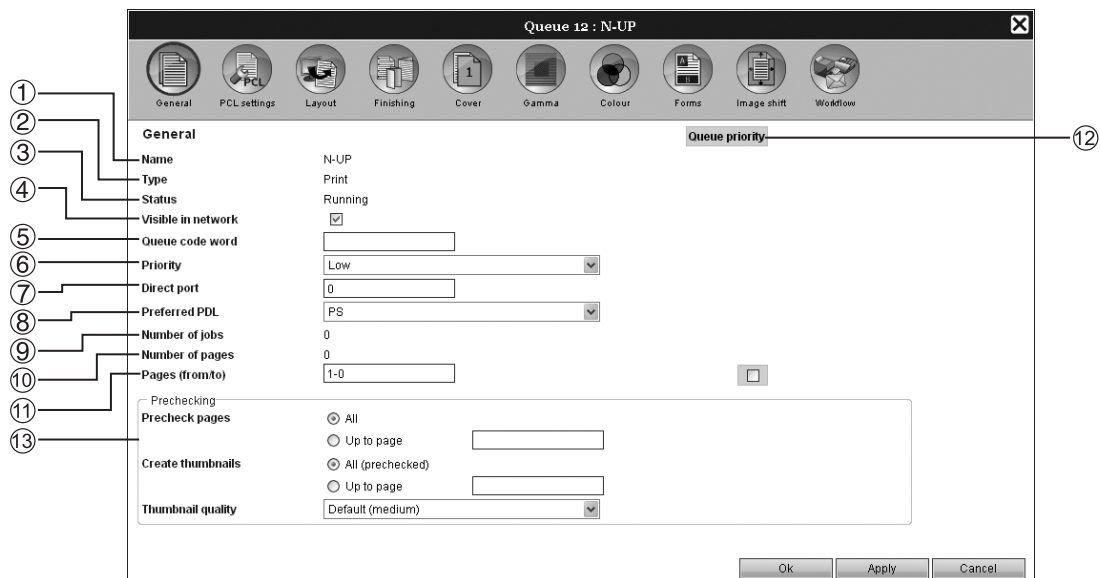

### Information displayed / Settings

- 1) Name**  
Displays the name of the queue.
- 2) Type**  
Displays the type of queue (Print or Hold).
- 3) Status\***  
Displays the current status of the queue (whether or not it has been stopped).
- 4) Visible in network**  
When placing a checkmark, the queue is displayed in the network.  
To hide the queue display on the network, remove the checkmark.
- 5) Queue cord word (1 to 8-digit numbers)**  
Set the password of queue if necessary.  
When the password is set, the job sent to the queue from the computer can be added to the queue only when the correct password has been input in **[Workflow]** of the printer driver. When the password is incorrect, the job is stored in the **[Hold]** queue.  
For the print settings from the computer, refer to the separate manual, "ComColorExpress IS700C Printer Driver Guide."
- 6) Priority\***  
Sets the priority (low, middle, high) of the queue.
- 7) Direct port\***  
Sets the port number (9100-9999) of the RAW port.
- 8) Preferred PDL\***  
Sets the page description language (PDL) to be received by the RAW port (PS or PCL).  
When received by a port other than the RAW port, PDL is automatically detected.
- 9) Number of jobs**  
Displays the number of jobs in the queue.
- 10) Number of pages**  
Displays the total number of pages of the jobs in the queue (the number of pages of each job x the number of copies).
- 11) Pages (from/to)**  
Specify the range of pages to be processed "From page" - "To page".  
**Note:**  
• To specify all pages, enter "1-0."
- 12) Queue priority**  
When placing a checkmark, the settings of queue are prioritized over the settings for the printer driver.
- 13) Prechecking**  
Sets the pre-flight (the data check before output and the creation of thumbnails).  
**[Precheck pages]:** Specify the pages to check. Select **[All]** or enter the last page in **[Up to page]**.  
**[Create thumbnails]:** Set the thumbnails to create. Select **[All (prechecked)]** or enter the last page in **[Up to page]**  
**[Thumbnail quality]:** Select the image quality of thumbnails from the following five levels.  
Lowest (high-speed processing) / Low / Default (medium) / High / Highest (low-speed processing)

\*: Displayed only when the type of queue is "Print".

## [PCL settings] screen

This screen displays settings concerning PCL job processing.

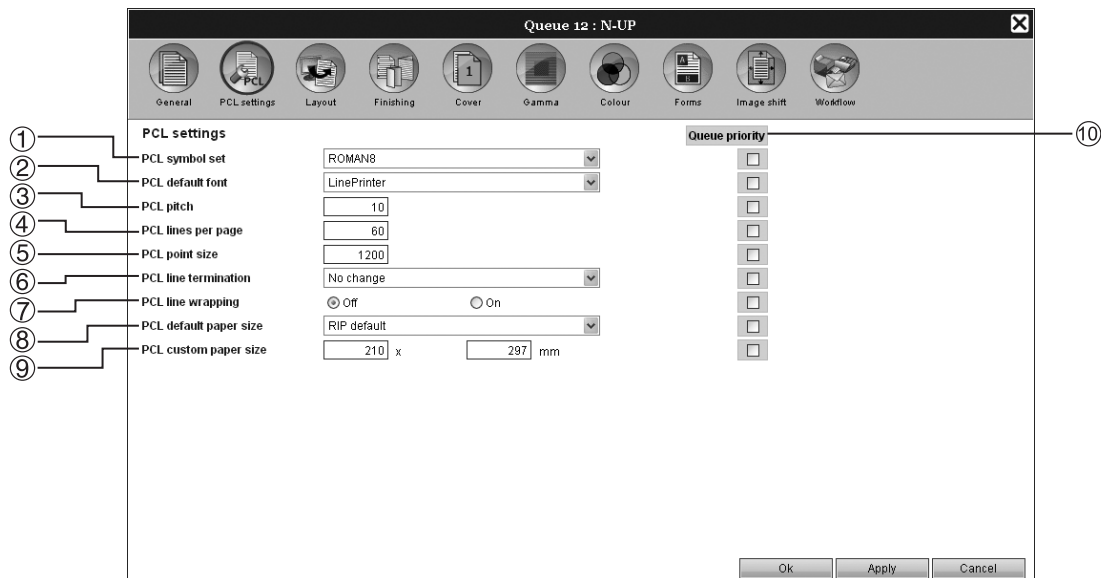

### Settings

- 1) **PCL symbol set**  
Select the symbol set (the encoding of character).
- 2) **PCL default font**  
Select the PCL font.
- 3) **PCL pitch**  
Set the pitch of font (the number of characters in 1 inch).
- 4) **PCL lines per page**  
Set the lines per page.
- 5) **PCL point size**  
Set the font size for proportional fonts.
- 6) **PCL line termination**  
Select the conversion process of linefeed code.  
**[No change]:** Select to print a text file from a Windows computer.  
**[Add LF after CR]:** Select to print a text file from a Macintosh computer.  
**[Add CR before LF + FF]:** Select to print a text file from a UNIX computer.  
**[Add LF, add CR]:** Select to add both "LF" and "CR."
- 7) **PCL line wrapping**  
Select whether to use automatic wrapping according to the width of the page or not.
- 8) **PCL default paper size**  
Select the paper size to be applied when the information about paper size is not contained in a PCL job.
- 9) **PCL custom paper size**  
When **[Custom]** is selected in **[PCL default paper size]**, set the width and the height of paper (mm).
- 10) **Queue priority**  
When placing a checkmark, the settings of the queue are prioritized over the settings for the printer driver.

## Stopping Queue Processing [Stop]

---

Queue processing can be stopped.

Move the mouse pointer over the **[Queue]** menu button and then click **[Stop]** in the displayed submenu.

**Note:**

- After selecting the queue button, processing can be also stopped by clicking  of the Job / Queue information display (on the right side of the screen) in the state that the job is unselected.

## Resuming Queue Processing [Start]

---

Processing of a queue that has been stopped can be resumed.

Move the mouse pointer over the **[Queue]** menu button and then click **[Start]** in the displayed submenu.

**Note:**

- After selecting the queue button, processing can be also resumed by clicking  of the Job / Queue information display (on the right side of the screen) in the state that the job is unselected.

---

# Rebooting the Print Controller

You can reboot the print controller from the RISO Console.

- 1 Move the mouse pointer over the [RIP] menu button and then click [RIP reboot] in the displayed sub-menu.**
- 2 Click the [Yes] button on the confirmation dialog box.**

The print controller will reboot.

# Shutting Down the Print Controller

You can shut down the print controller and turn the power off from the RISO Console.

- 1 Move the mouse pointer over the [RIP] of menu button and then click [RIP shutdown] in the displayed sub-menu.**
- 2 Click the [Yes] button on the confirmation dialog box.**

The print controller will shut down.



# Using the Included Utility Software

When you execute the setup from the CD-ROM that comes with this product, the following utility software is installed.

## Utility Software

### ◆ RISO Printer Driver (Installer)

Installer for the IS700C printer driver

### ◆ RISO Management Tool

Utility for setting the IP address of the IS700C on the network and starting the print controller by remote control

### ◆ SMAP

Direct print utility that allows printing by the dragging and dropping files

This chapter describes the functions and how to operate the RISO Management Tool and SMAP.

#### **Note:**

- For software installation, refer to the separate manual, “ComColorExpress IS700C Setup Guide”.
- For information on the RISO Printer Driver, refer to the separate manual, “ComColorExpress IS700C Printer Driver Guide”.

# Using the RISO Management Tool

The RISO Management Tool allows the user to easily search the print controller on the network, set IP addresses, and start the print controller from the computer. The RISO Console can also be easily started from the RISO Management Tool.

## Note:

- When the IS700C is newly connected to a network, the network settings of the print controller can be made from the RISO Management Tool. For details, refer to the separate manual, "ComColorExpress IS700C Setup Guide".

## Starting the RISO Management Tool

### For Windows:

From the **[Start]** menu of the Windows computer, select **[All Programs]** (Windows XP / Windows 2003 Server) or **[Programs]** (Windows 2000) -> **[RISO]** -> **[RISO IS700C]** -> **[RISO Management Tool]**.

### For Macintosh:

Select **[Applications]** folder -> **[RISO Client Software]** -> **[RISO Management Tool]**.

## Basic screen

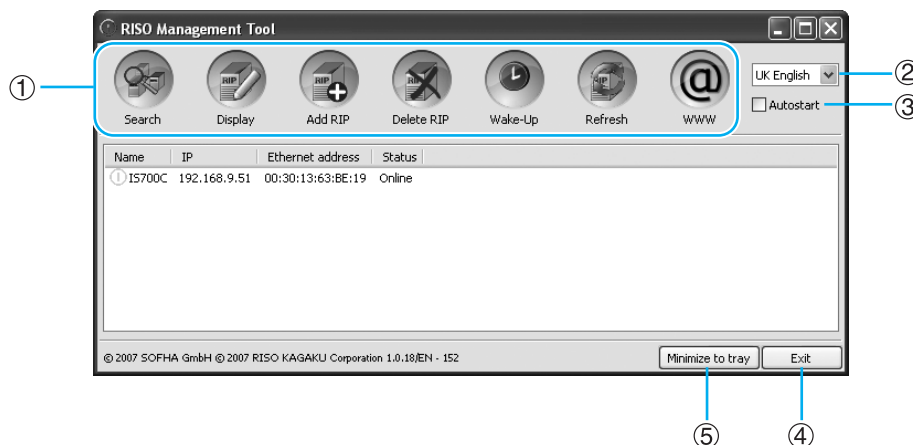

### 1) Menu

When clicking, the corresponding function is executed. For details, see the next page onward.

### 2) Language selection

From the language selection box on the right side of the screen, select the language for messages displayed on the RISO Management Tool.

### 3) Autostart

When placing a checkmark, the RISO Management Tool is set to automatically start when the computer starts.

### 4) Exit

Displays the outline and communication settings of the print controller.

### 5) Minimize to tray

When clicking, the screen of the RISO Management Tool is minimized and stored in the task tray.

When clicking the RISO Management Tool icon, the basic screen is displayed.

The RISO Management Tool icon is displayed in the task tray.



When the mouse is moved over the RISO Management Tool icon, the status of all the print controllers added to the RISO Management Tool can be viewed as a popup.

## Searching for Print Controllers on the Network

Click **[Search]** on the basic screen of the RISO Management Tool.

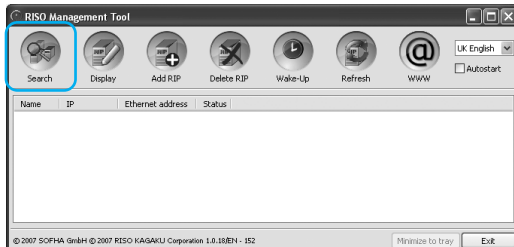

The IS700C connected to the network are displayed on the screen.

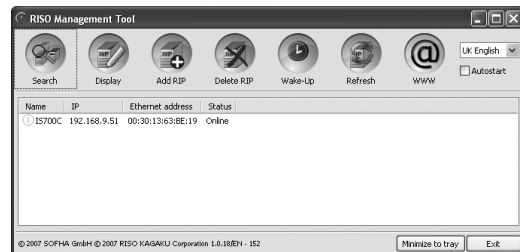

**Note:**

- If the computer and the print controllers are not connected to the same network segment, the print controllers will not be found. Add the printer controller to the list as explained in “Adding Print Controllers to the List”. p.79

## Displaying Print Controller Settings

**1** On the basic screen of the RISO Management Tool, select the name of a connected controller from the list.

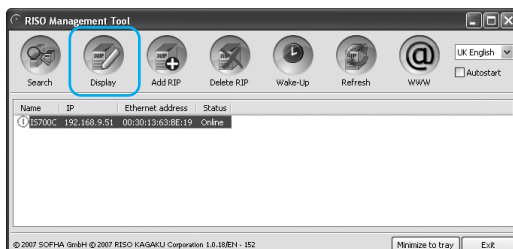

**2** Click **[Display]**.

The communication settings screen of the print controller is displayed.





## Adding Print Controllers to the List

When the print controller connected to the network cannot be automatically detected, the print controller can be manually added to the list.

- 1 On the basic screen of the RISO Management Tool, click [Add RIP].  
The communication settings screen is displayed.

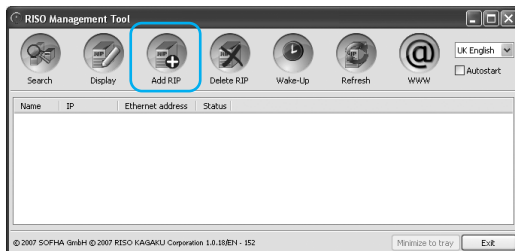

- 2 Enter the “RIP Name” or “IP address” of the print controller you want to add to the list, and click the [OK] button.

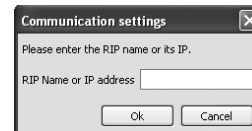

### Note:

- For the “RIP Name” and “IP address”, confirm with your network administrator.

When the relevant print controller is detected, it is displayed in the list.

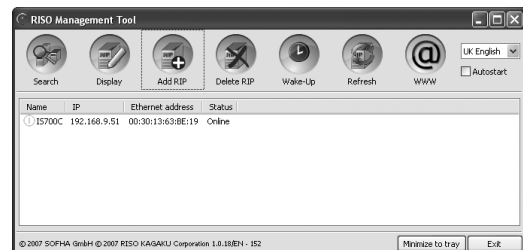

## Deleting Print Controllers from the List

- 1 On the basic screen of the RISO Management Tool, select the RIP name you want to delete from the list.

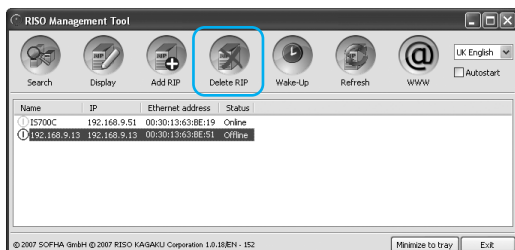

- 2 Click [Delete RIP].  
The selected RIP name is deleted from the list.

## Starting Up Print Controllers

When the print controller displayed in the list of the RISO Management Tool is sleeping (the power of the connected printer has been turned off), the print controller can be started up from the computer.

**1 On the basic screen of the RISO Management Tool, select the RIP name of the sleeping print controller from the list.**

**2 Click [Wake-Up].**

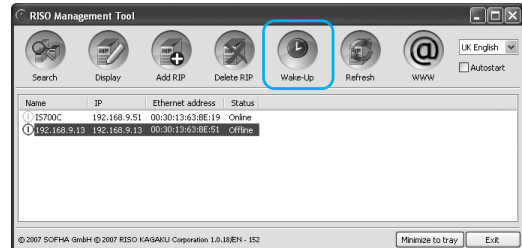

The printer starts up, and the status is displayed in the list.

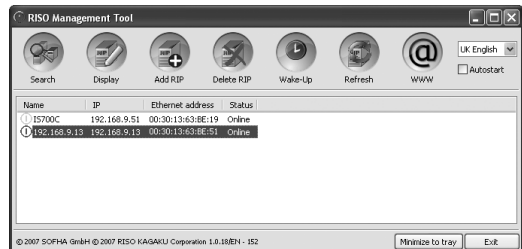

## Displaying Latest Status

**On the basic screen of the RISO Management Tool, click [Refresh].**

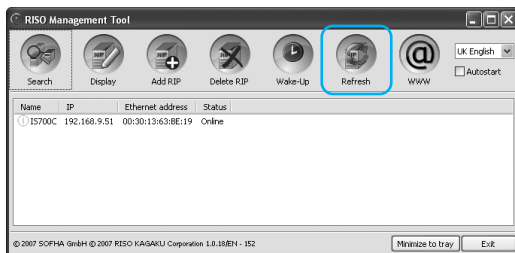

The latest status of the print controllers displayed in the list is displayed.

# Starting Up the RISO Console

From the RISO Management Tool, the status of the printer controller can be checked and the RISO Console that manages jobs and queues can be started.

**On the basic screen of the RISO Management Tool, select the target RIP name from the list and click [WWW].**

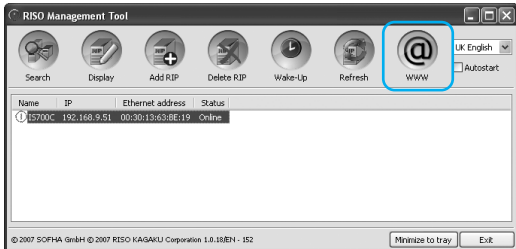

The Web browser starts, and the RISO Console screen for the selected print controller is displayed.

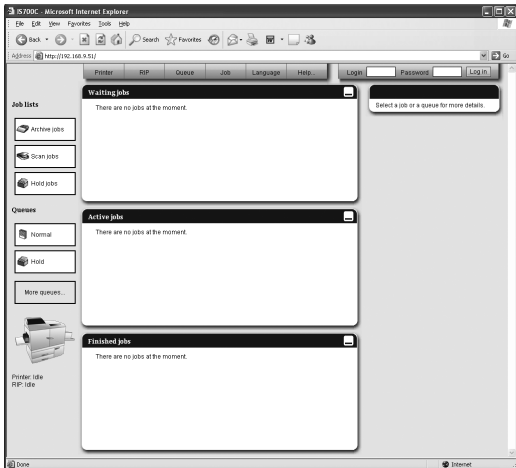

For available functions and operation procedures of the RISO Console screen, see “RISO Console” p.6 and “Administrator Settings”. p.44

# Using SMAP

SMAP allows the user to quickly print files by simply adding the file to SMAP without opening the application software used to create the file. The file is printed at the processing settings registered in the queue of the specified print controller.

## Starting SMAP

---

### For Windows:

From the **[Start]** menu of the Windows computer, select **[All Programs]** (Windows XP / Windows 2003 Server) or **[Programs]** (Windows 2000) -> **[RISO]** -> **[RISO IS700C]** -> **[SMAP]**.

### For Macintosh:

Select **[Applications]** folder -> **[RISO Client Software]** -> **[SMAP]**.

The basic screen is displayed.

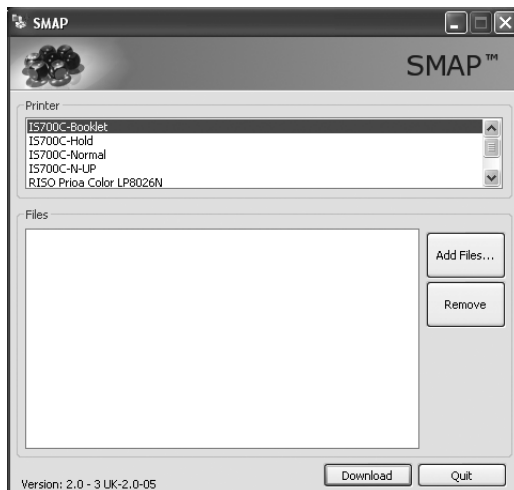

When quitting SMAP, click the **[Quit]** button.

## Direct Printing by SMAP

- 1** On the basic screen of SMAP, select the print controller (print driver) to send the original data.

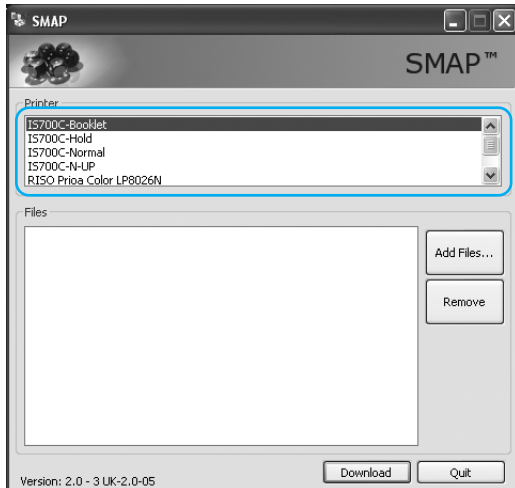

On the printer list, the printer drivers installed in your computer are displayed. When installed in the standard way, the printer driver for the IS700C is displayed in the form of "RIP name" - "Queue." (Example) IS700C-Normal

- 2** Click the [Add Files] button.

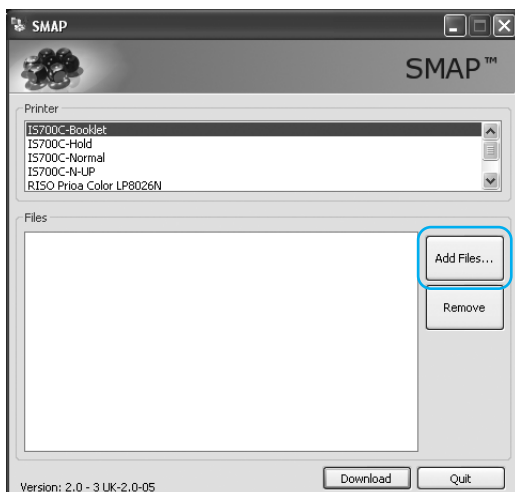

**Note:**

- Files can also be added by dragging and dropping them on the SMAP screen.

- 3** Select the file to print, and click the [Open] button.

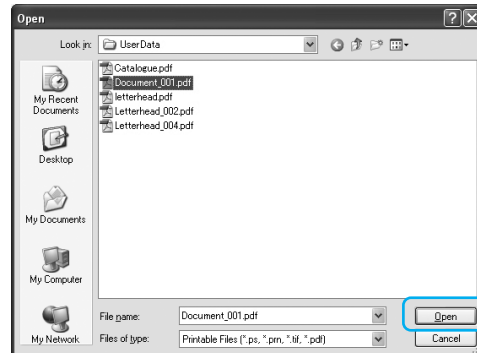

**Note:**

- The file formats in which files can be printed are as follows.  
PostScript, PCL, ASCII text, PDF file, PPML (as option)
- To add multiple files, repeat steps 2 and 3.
- To remove the added file, select the file you want to remove from the file list on the basic screen of SMAP, and click the [Remove] button.

- 4** Click the [Download] button.

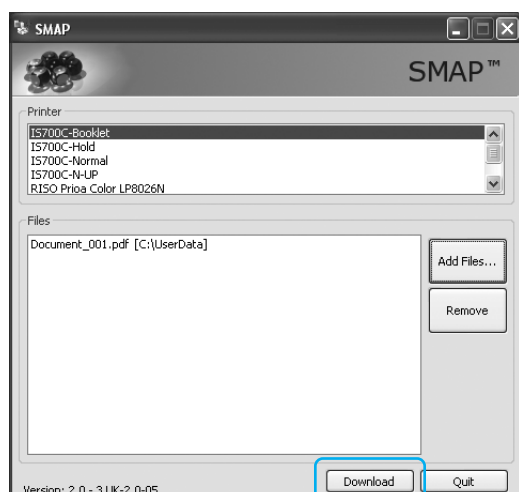

The original data is sent to the specified queue of the print controller, and processing starts.

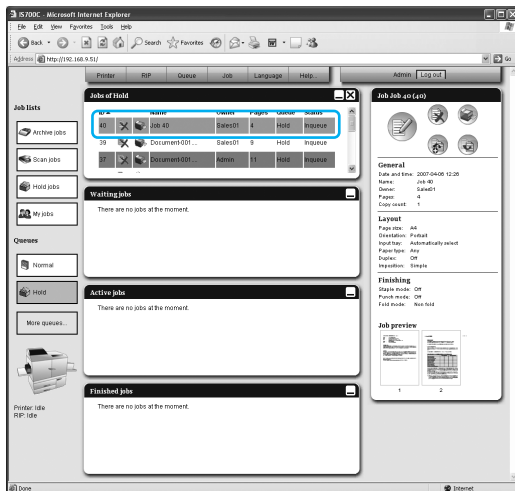

## Dragging and Dropping Files on the SMAP Icon on the Desktop

With the creation of a SMAP shortcut icon on the desktop, direct printing can be executed by simply dragging and dropping files on the shortcut icon.

- 1 Drag and drop the file to print onto the SMAP icon.**



The list of print controllers (printer drivers) is displayed as a popup.

- 2 Select the print controller (including the queue) to send the original data.**

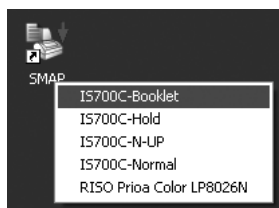

The original data is sent to the specified queue of the print controller, and processing starts.



# Using the Touch Panel Display (Option)

Connecting the optional Touch Panel Display to ComColorExpress IS700C enables you to check the printer status, configure the print controller settings, and conduct job management. In addition, you can operate copying and scanning functions.

## Touch Panel Screen

After the print controller starts, the start menu below is displayed on the Touch Panel Display.

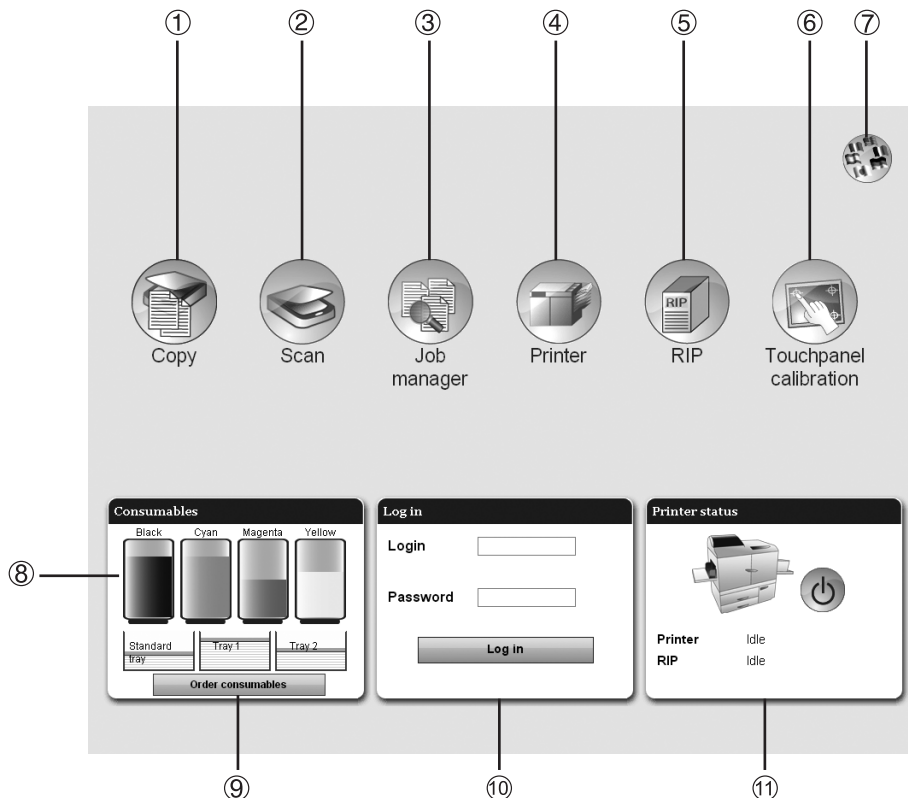

- 1) Copy\***  
Displays the copying function operation screen. [p.95](#)
- 2) Scan\***  
Displays the scanning function operation screen. [p.101](#)
- 3) Job manager**  
Displays the job manager screen of the print controller. [p.93](#)
- 4) Printer**  
Displays the printer status screen. [p.94](#)
- 5) RIP**  
Displays the management screen of the print controller. [p.94](#)
- 6) Touchpanel calibration**  
Enables you to conduct Touch Panel position calibration. [p.87](#)
- 7) Language**  
Enables you to change display language settings. [p.88](#)
- 8) Consumables**  
Displays the printer's remaining ink and paper levels.
- 9) Order consumables**  
Displayed when **[Show web link]** has been set in the RISO Console. [p.57](#)
- 10) Log in**  
Enter the login ID and password here to login to the print controller. [p.89](#)
- 11) Printer status**  
Displays the current status of the printer and the print controller. You can also reboot and shutdown the print controller from here. [p.108](#)

\* The optional scanner is required when using the copying and scanning functions.

The start menu (the screen to be displayed when the Touch Panel Display starts) can be changed from the RISO Console. For details, see "Touch panel settings". [p.56](#)



# Calibrating the Touch Panel Display

When the touch positions and screen display on the Touch Panel Display require calibration (when a button does not respond when touched, etc.), the calibration should be carried out in the following way. Even after the print controller is reset, the Touch Panel Display requires calibration.

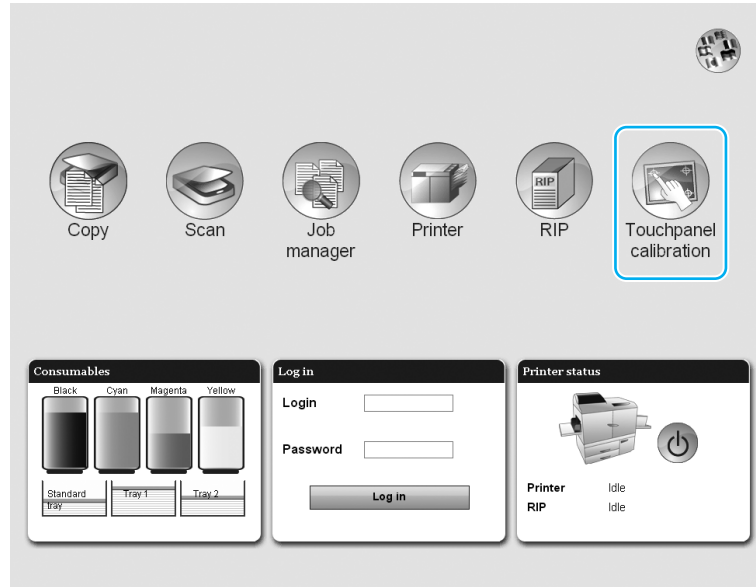

## 1 On the start menu, touch [Touchpanel calibration].

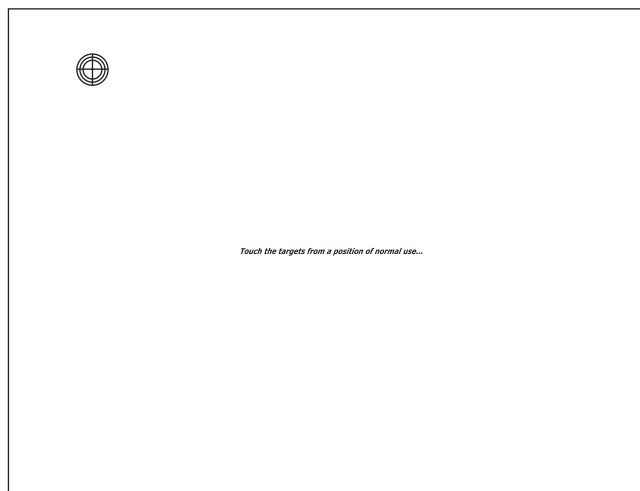

The following screen is displayed.



## 2 Touch the position shown by .

The  is displayed three times (in three positions). Ensure that you touch the centre of the . When the calibration has been completed, the screen returns to the start menu.

### Important!:

- When any place other than  is touched, the Touch Panel Display cannot be correctly operated afterwards. When the calibration has failed, enter `http://(IP address of the controller)/tp_calibrate.php` in the URL input area on the web browser of the computer. When the calibration screen is displayed on the Touch Panel Display, carry out the calibration by correct operation.

# Selecting Languages

This screen is for selecting the language for messages displayed on the Touch Panel Display.

- 1 Touch the icon in the upper right corner of the start menu.

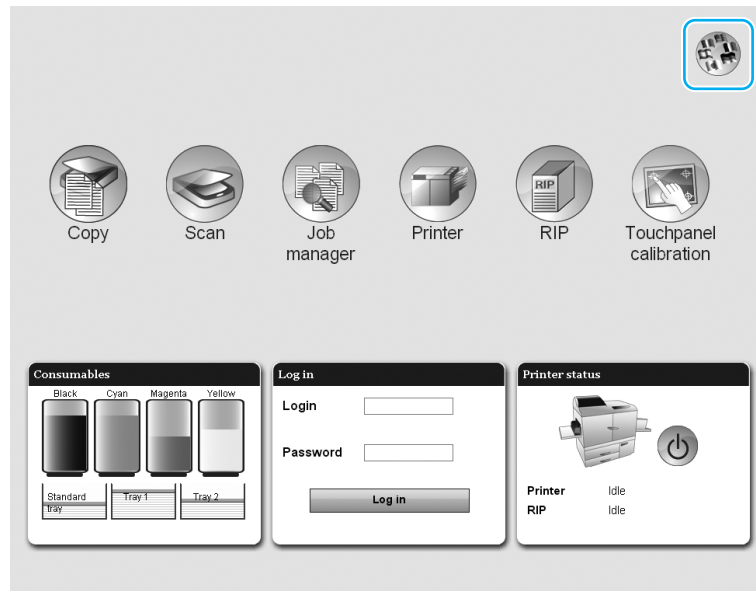

- 2 Touch the language button of the new language.

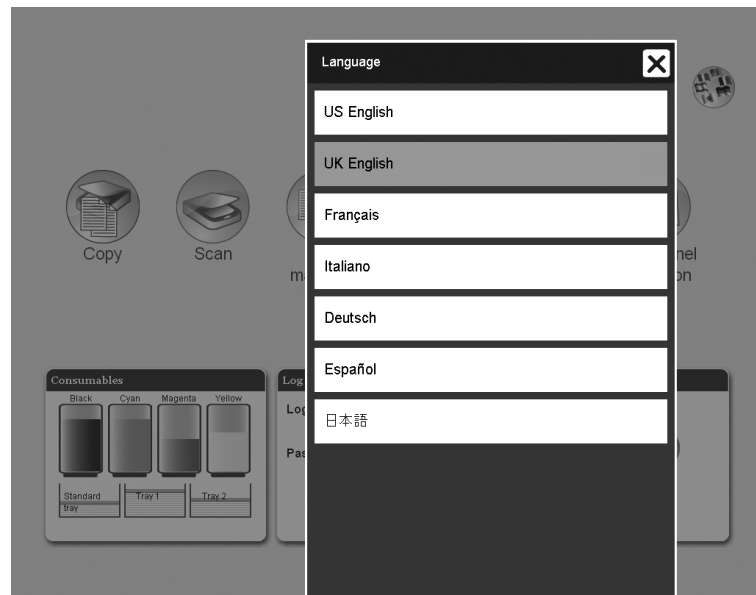

The screen returns to the start menu, and the language display switches to the selected language.

# Logging In from the Touch Panel Display

For access authority of the print controller, see “Logging in to the Print Controller”. [p.8](#)

## Note:

- The “Login (ID)” and “Password” should be registered in the RISO Console by the administrator in advance. [p.48](#)  
For details, confirm with your network administrator.
- When **[Enforce login]** is set to “ON” on the RISO Console, functions other than the login operation are disabled.  
(Language selection, touch panel calibration, and reboot / shut down of the print controller are available.)

## 1 Touch the [Login] input area on the start menu.

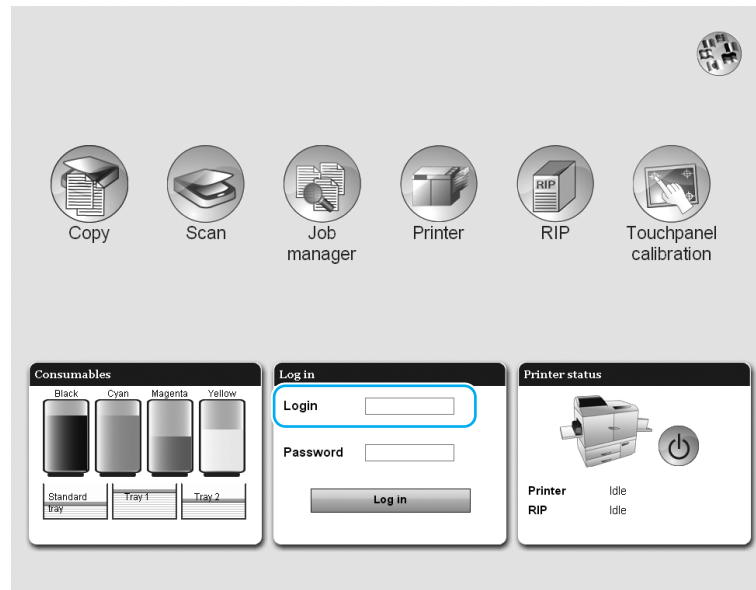

The login name selection screen or the login ID input screen is displayed.

## 2 Enter the login ID.

### ◆ When [Userlist at login] has been enabled on the RISO Console

Touch the login name on the [Select user] screen.

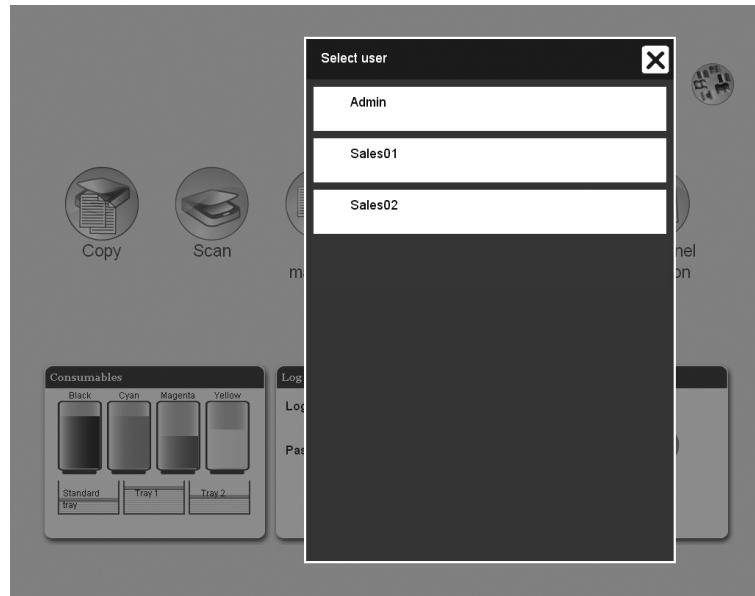

The screen returns to the start menu, and the selected login ID is displayed in the input area.

### ◆ When [Userlist at login] has been disabled on the RISO Console

Enter the login ID on the text entry screen, and touch [Enter].

For instructions on how to enter the text, see “Text Input Method”. [p.92](#)

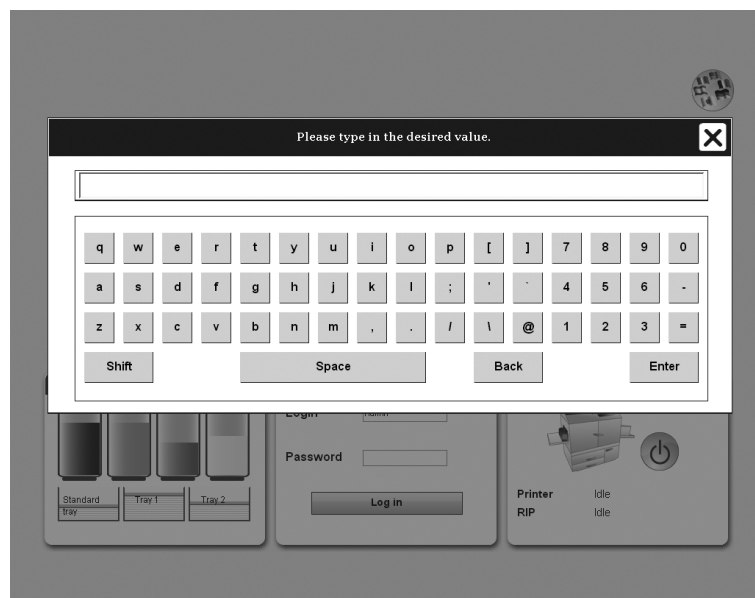

The screen returns to the start menu, and the entered login ID is displayed in the input area.

#### Note:

- For instructions on how to set [Userlist at login], see “Touch panel settings”. [p.56](#)

### 3 Touch the [Password] input area on the start menu.

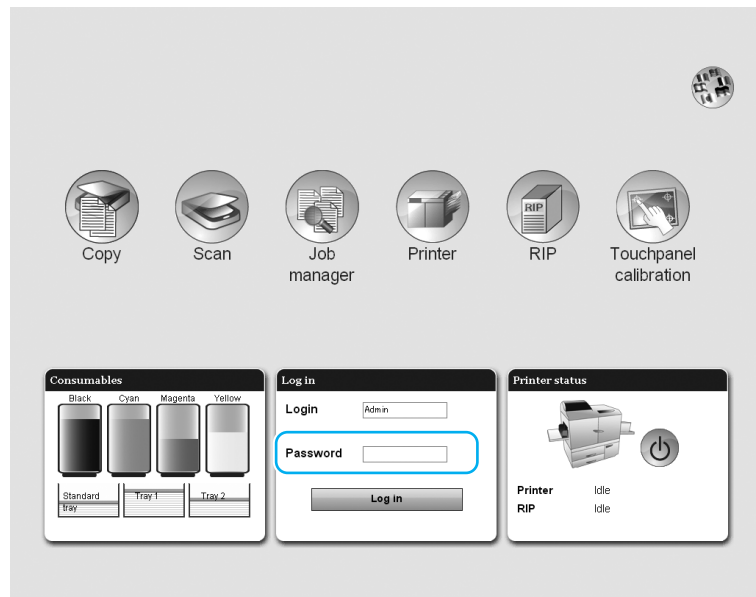

### 4 Enter the password.

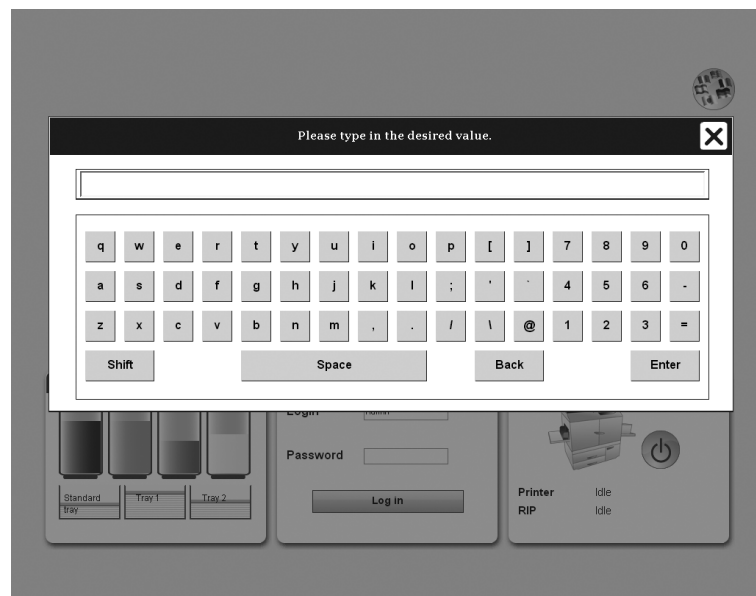

For instructions on how to enter the text, see “Text Input Method”. [p.92](#)  
In place of the text you have entered, “\*” is displayed on the screen.

### 5 Touch [Enter].

The screen returns to the start menu, and “\*” is displayed in the input area.

## 6 Touch [Log in].

When you log in to the print controller, the **[Log out]** button is displayed on the Touch Panel Display.

**Note:**

- When the login ID or password is incorrect, an error message is displayed on the Touch Panel Display. Reenter the login ID and the password.

To log out, touch **[Log out]**.

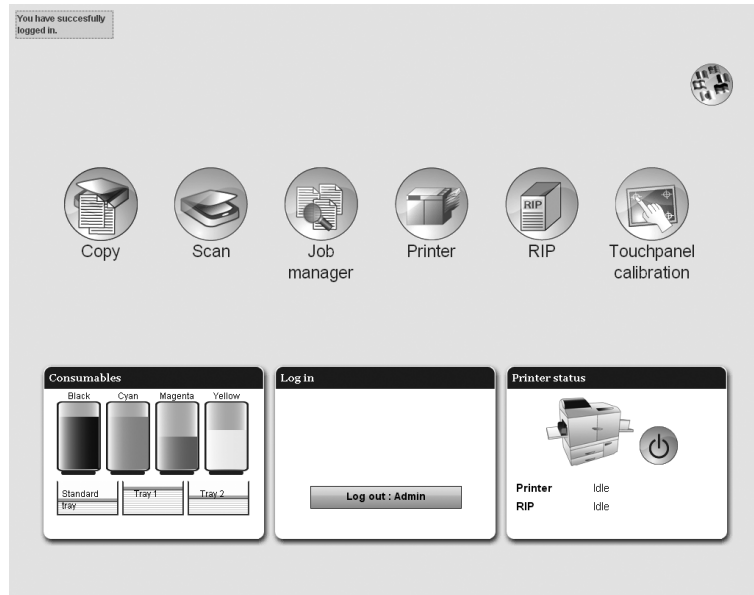

## Text Input Method

When entering text and numeric values such as login ID, password, RIP name, and IP address, the following screen is displayed.

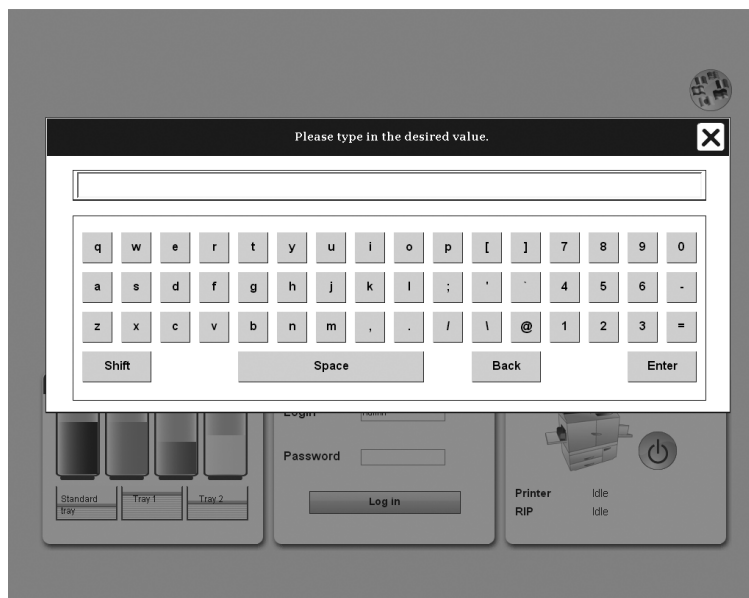

Entered text display area: Displays the text you have entered.

When you want to clear all of the entered text, touch this display area.

Alphanumeric characters and symbols button: Touch the buttons to enter the character string.

**[Shift]**: Switches between upper case and lower case.

**[Space]**: Enters a space (blank).

**[Back]**: Deletes the first character from the right.

**[Enter]**: Enters the text you have entered, and closes the screen.

**[X]**: Cancels the entry and closes the screen.

# Job Manager screen

When you touch [Job manager] on the start menu, the following screen is displayed.

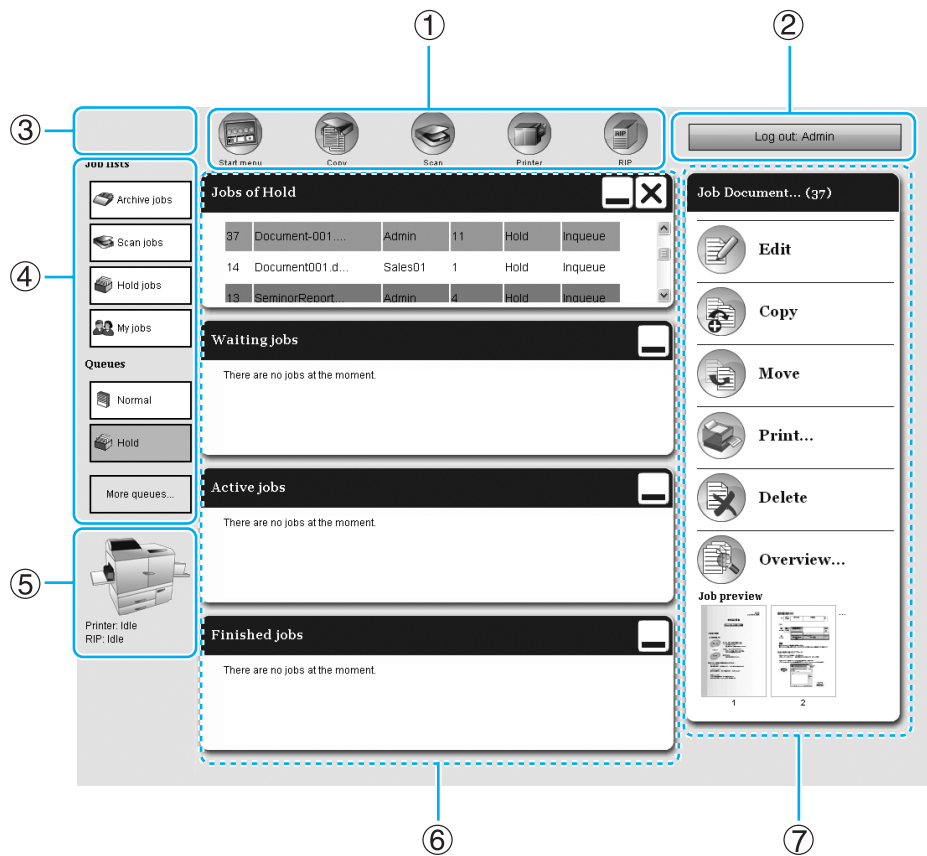

## 1) Menu

When touched, the screen changes to a screen with corresponding functions.

## 2) Log out button

Displayed while logging in as a user or an administrator.

## 3) Message display area

Confirmation messages and error messages related to the operation of the touch panel are displayed.

## 4) Job / Queue selection buttons

Clicking the buttons of queues and jobs switches the information displayed in the job list area.

## 5) Status display area

Displays the current status of the printer and the print controller.

## 6) Job list

The jobs in the print controller are listed by processing status.

- Job list in the queue  
The list is displayed of the job in the selected queue or jobs of the selected job type.

## • Waiting jobs

The list is displayed of jobs waiting in the print controller.



## • Active jobs

Jobs being interpreted or printed in the print controller are displayed.

## • Finished jobs

The list is displayed of interpreted, printed and cancelled jobs.

## Note:

- Clicking  in the upper-right corner of each list box minimizes the list box. Clicking  when the list box is minimized returns the list box to the normal display. Clicking  in the upper-right corner of the [Jobs of queue] list box closes the list box.

## 7) Job / Queue information display

When a queue is selected, icons are displayed for a setting outline and functions of the queue.

When a job is selected in the job list, icons are displayed for a setting outline and various functions of the job.

The functions and the operation methods are the same as the RISO Console. For details, see "Queue" [p.10](#), "Job (Job manager)" [p.14](#), and "Administrator Settings" [p.44](#).

# Printer Screen

When you touch **[Printer]** on the start menu, the following screen is displayed.

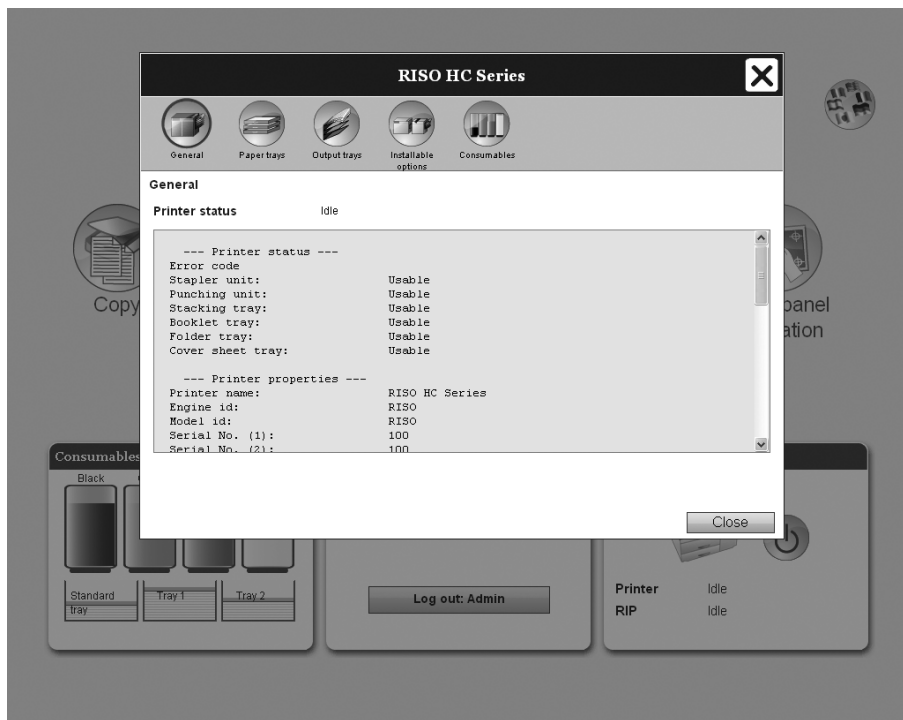

For details, see “Checking Printer Status”. p.41

# Controller Screen

When you touch **[RIP]** on the start menu, the following screen is displayed.

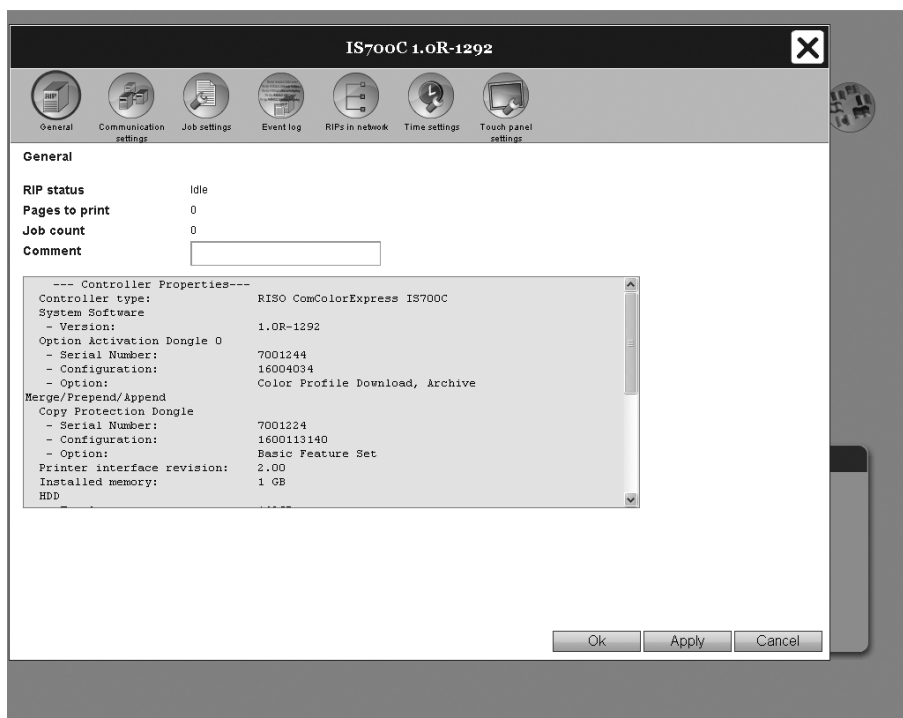

For details, see “Detailed Settings of the Print Controller”. p.45



# How to Use Copy Functions

When you touch **[Copy]** on the start menu, the following screen is displayed.

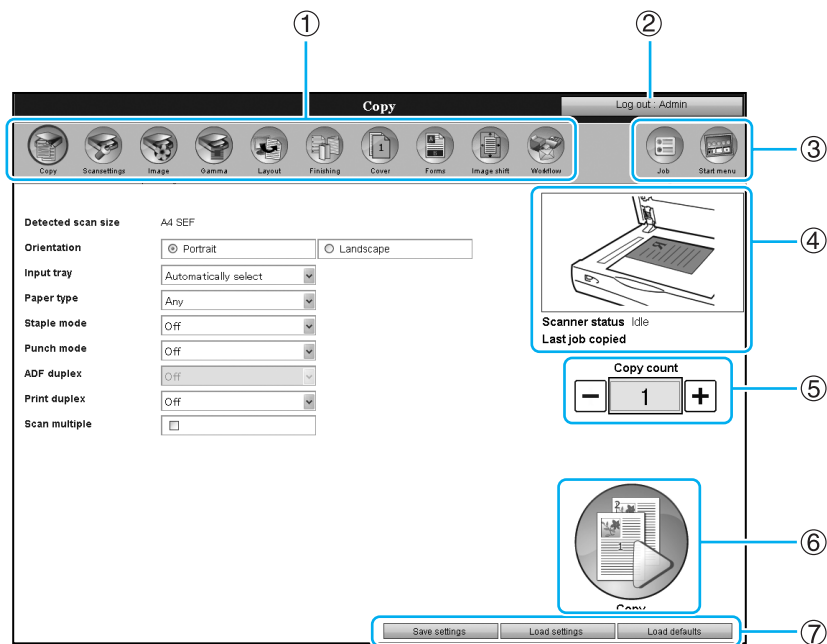

## 1) Copy setting screen selector buttons

When touched, the screen switches to the corresponding setting screen.

## 2) Log out button

Displayed while logging in as a user or an administrator.

## 3) Screen selector buttons

When touched, the copy function ends and the screen switches to another screen.

## 4) Status display area

Displays the current status of the scanner, and ID of the last job.

## 5) Copy count

The copy count can be set by touching **[-]** and **[+]**. The copy count can also be entered by touching the number input area and using the numeric keypad that is displayed.

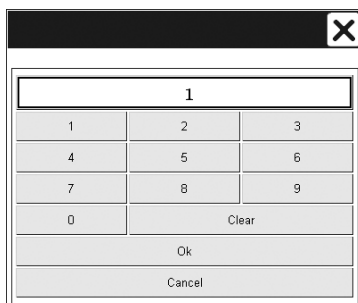

## 6) Copy start button

When touched, copying starts.

During copy processing, the following screen is displayed. To cancel the copy processing, touch **[Cancel]**.

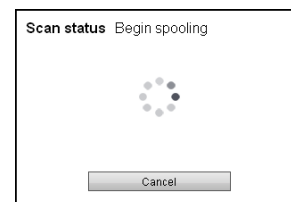

## 7) Save settings / Load settings / Load defaults

The current copy settings can be saved and loaded.

**[Save settings]:** Saves the current copy settings.

**[Load settings]:** Loads the saved copy settings.

**[Load defaults]:** Returns copy settings to the default settings.

### Note:

- Only one set of copy settings can be saved. When new settings are saved, the old settings are overwritten.
- These buttons are displayed only during user login or administrator login.

For the details of the **[Copy]**, **[Scansettings]**, **[Image processing]**, and **[Gamma]** screens, see the next page onward. For the details of the **[Layout]**, **[Finishing]**, **[Cover]**, **[Forms]**, **[Image shift]**, and **[Workflow]** screens, refer to the separate manual, "ComColorExpress IS700C Printer Driver Guide".

# Copy

This screen is for basic copy settings.

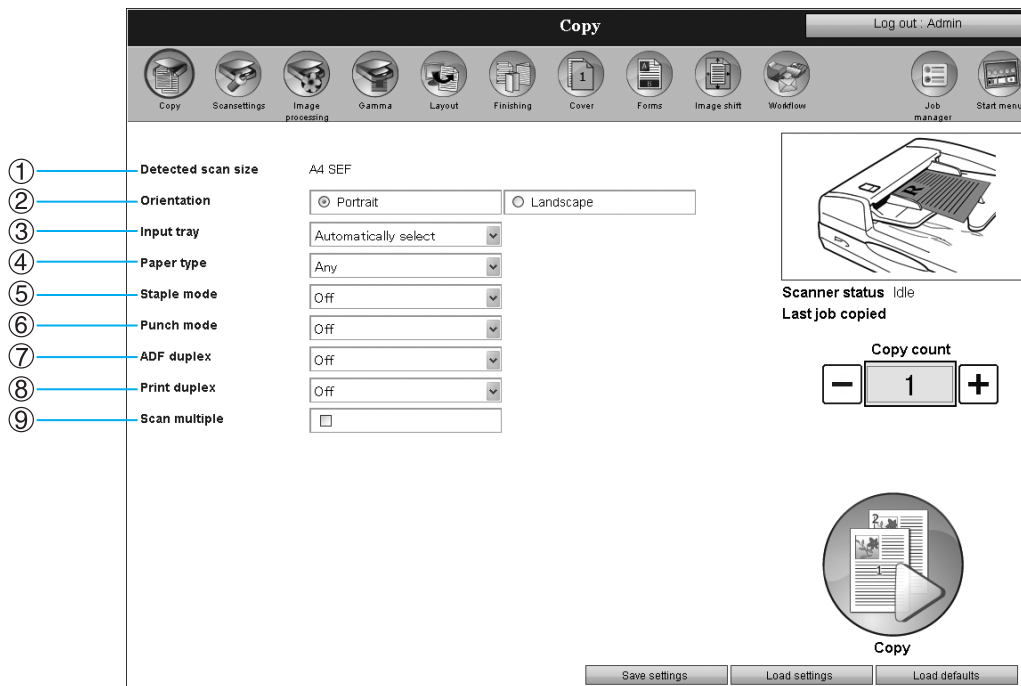

## Information displayed / Settings

- 1) **Detected scan size**  
Displays the size and orientation of the original set on the platen glass of the scanner or in the auto feeder.
- 2) **Orientation**  
Selects the orientation for printing the original.
- 3) **Input tray**  
Selects the tray holding the paper for printing.
- 4) **Paper type**  
Selects the paper type.
- 5) **Staple mode\***  
Staples printed paper.
- 6) **Punch mode\***  
Punches holes in printed paper.
- 7) **ADF duplex**  
Place a checkmark to scan duplex originals using the auto feeder.

- 8) **Print duplex**  
Select for duplex printing.
- 9) **Scan multiple**  
Place a checkmark to scan originals multiple times. When placing a checkmark in the **[Scan multiple]** check-box, the following screen is displayed and the application goes on standby for 90 seconds at the end of scanning of originals that were set after the start of copying.

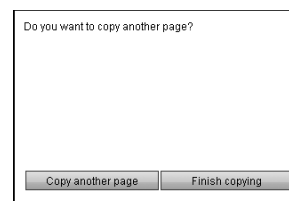

**[Copy another page]:** When touched after additional originals are set, the scanning of next original starts.  
**[Finish copying]:** Ends copy processing.

\* The Staple mode and Punch mode are available when an HC Finisher is connected.

### Note:

- For the details of setting items, refer to the separate manual, "ComColorExpress IS700C Printer Driver Guide".

## Scan settings

This screen is for setting up original scanning by the scanner.

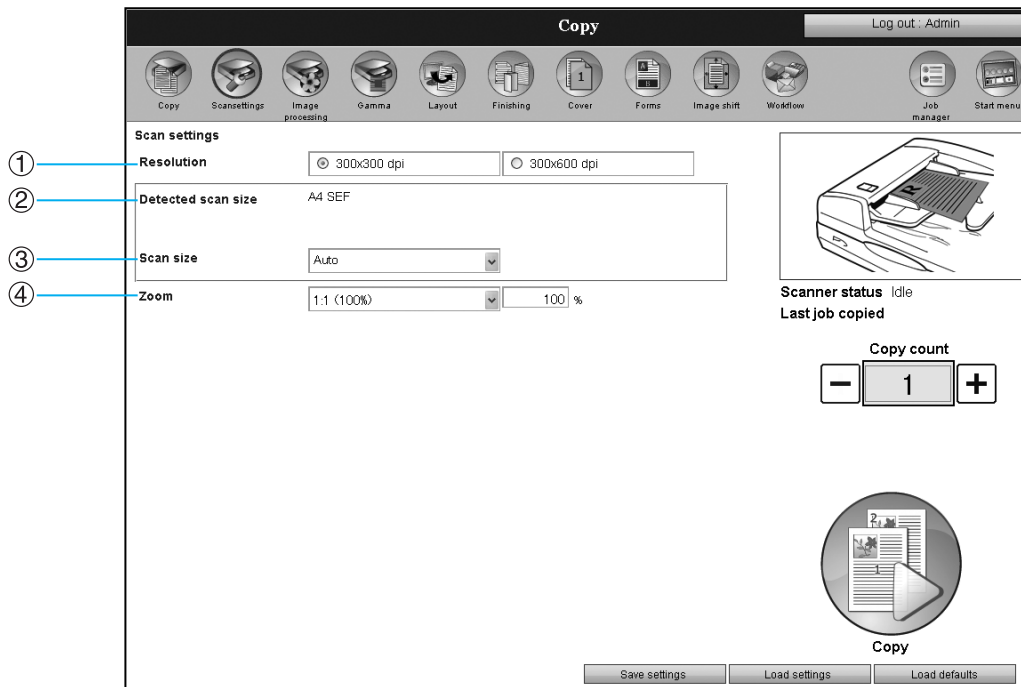

### Information displayed / Settings

- |  |  |
|--|--|
| <p><b>1) Resolution (dpi)</b><br/>Sets the image quality (resolution).</p> <p><b>2) Detected scan size</b><br/>Displays the size and orientation of the original set on the platen glass of the scanner or in the auto feeder.</p> | <p><b>3) Scan size</b><br/>Selects the size of the image to be scanned by the scanner.</p> <p><b>4) Zoom</b><br/>Specifies the enlargement / reduction rate for printing. Selects a fixed magnification from the combo box on the left side. The magnification (%) can also be entered by touching the number input area on the right side and using the numeric keypad.</p> |
|--|--|

### Note:

- For the details of setting items, refer to the separate manual, "ComColorExpress IS700C Printer Driver Guide".

## Image processing

This screen is for setting up image scanning.

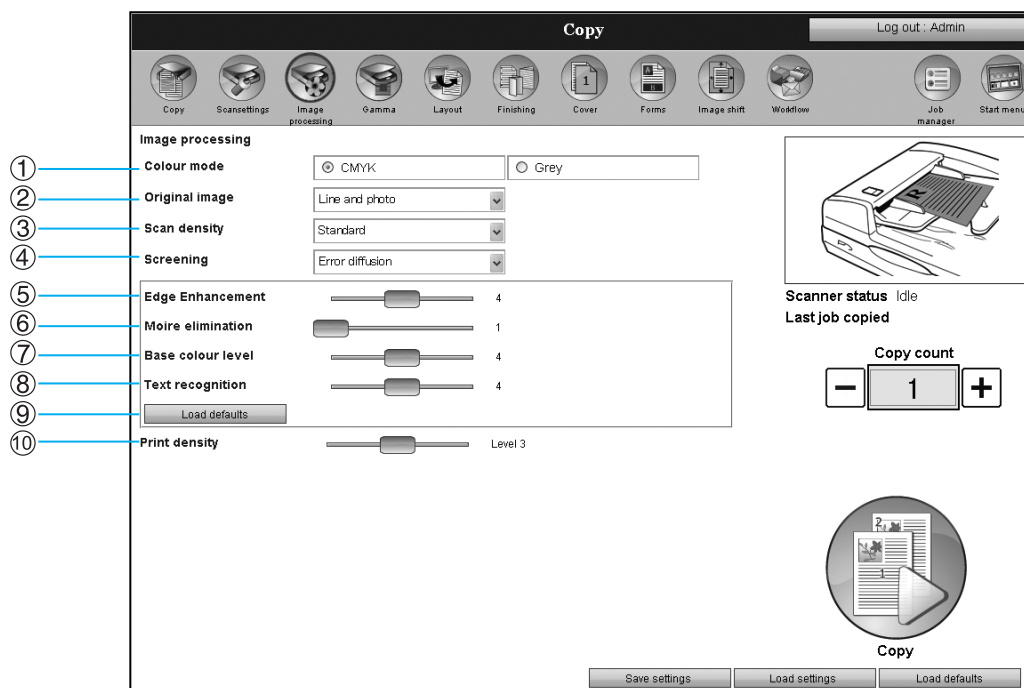

### Settings

#### 1) Colour mode

Selects colour or monochrome printing.

#### 2) Original image

Select the appropriate mode for the type of original (Line / Photo / Line and photo).

#### 3) Scan density

Select the scan density (Light / Standard / Dark) according to the condition of the originals.

#### 4) Screening

Select the halftone processing method (Error diffusion / Dot window (70 lpi) / Dot window (100 lpi)).

#### 5) Edge Enhancement

Adjust edge enhancement for characters and illustration from seven levels.

#### 6) Moire elimination

Adjusts moire elimination from seven levels.

#### 7) Base colour level

Adjusts scan processing not to scan the base and the back of originals from seven levels.

#### 8) Text recognition

Adjusts scan processing to distinguish character areas and image areas from seven levels.

#### 9) Load defaults

Loads the default settings for [Edge Enhancement], [Moire elimination], [Base colour level], and [Text recognition].

#### 10) Print density

Adjusts print density from five levels.

# Gamma

This screen is for adjusting the gamma of scanned images.

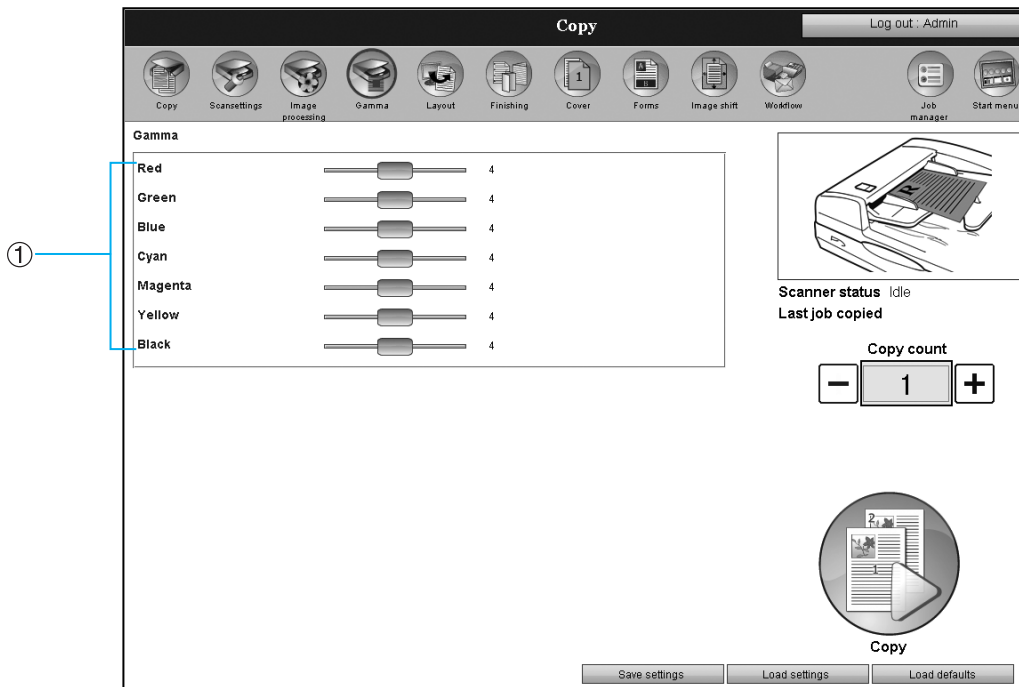

## Settings

### 1) Gamma adjustment of colours

Adjust the gamma of **[Red]**, **[Green]**, **[Blue]**, **[Cyan]**, **[Magenta]**, **[Yellow]**, and **[Black]**.

Setting a high gamma level value makes the colour darker, while setting a lower value makes the colour lighter.

## Management of Copy Jobs

After copy processing has been completed, touching **[Job manager]** displays information of the copy job on the job manager screen.

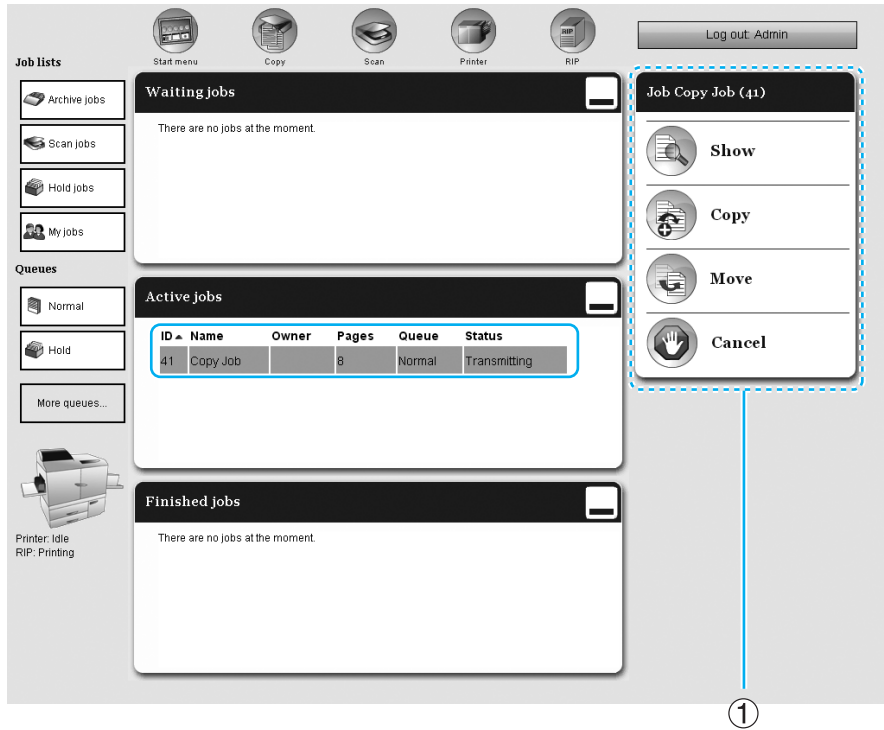

When a job is select on the job list, icons are displayed of operable functions (1) on the right side of the screen.

**Note:**

- The functions and the operation methods are the same as the RISO Console. For details, see “Job (Job manager)”. p.14

# How to Use Scan Functions

When you touch **[Scan]** on the start menu, the following screen is displayed.

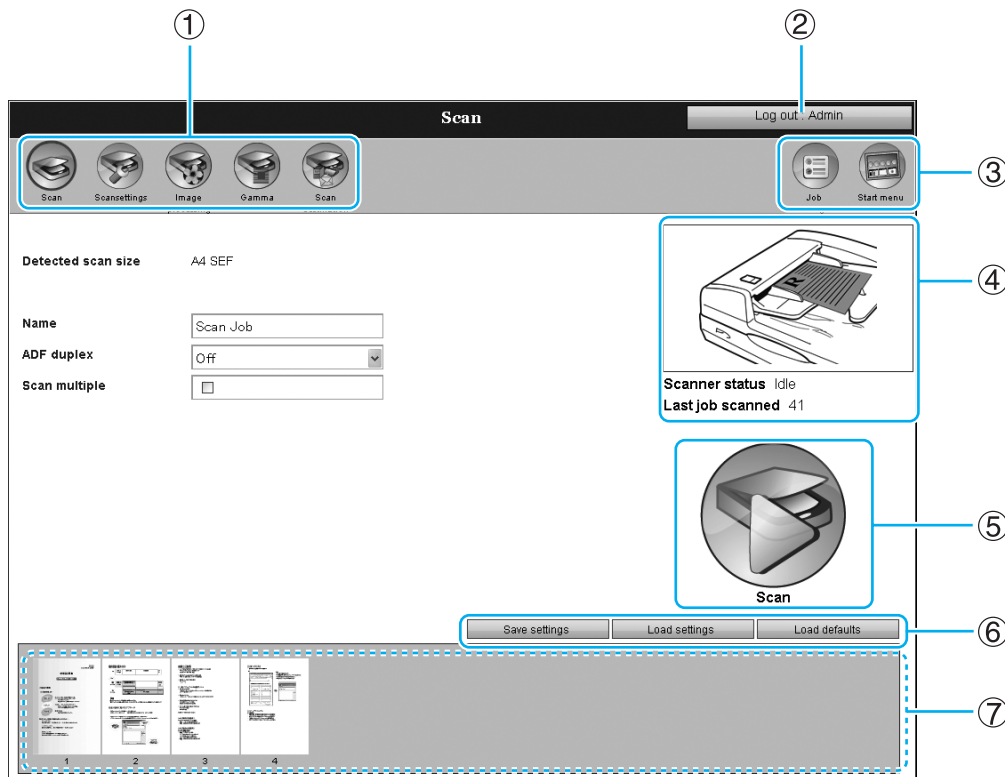

## 1) Scan setting screen selector buttons

When touched, the screen switches to the corresponding setting screen.

## 2) Log out button

Displayed while logging in as a user or an administrator.

## 3) Screen selector buttons

When touched, the scan function ends and the screen switches to another screen.

## 4) Status display area

Displays the current status of the scanner and ID of the last job.

## 5) Scan start button

When touched, scanning starts. During scan processing, the following screen is displayed. To cancel the scan processing, touch **[Cancel]**.

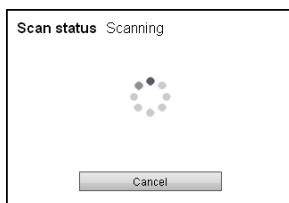

## 6) Save settings / Load settings / Load defaults

The current scan settings can be saved and loaded.

**[Save settings]**: Saves the current scan settings.

**[Load settings]**: Loads the saved scan settings, and overwrites the existing scan settings with the loaded scan settings.

**[Load defaults]**: Returns the scan settings to the default settings (factory settings).

### Note:

- Only one set of scan settings can be saved. When new settings are saved, the old settings are overwritten.
- These buttons are displayed only during user login or administrator login.

## 7) Preview area

Displays a thumbnail of images scanned by the scanner. When the thumbnail is touched, the image is enlarged.

For the details of the setting screens, see the next page onward.

# Scan

This screen is for making basic scan settings.

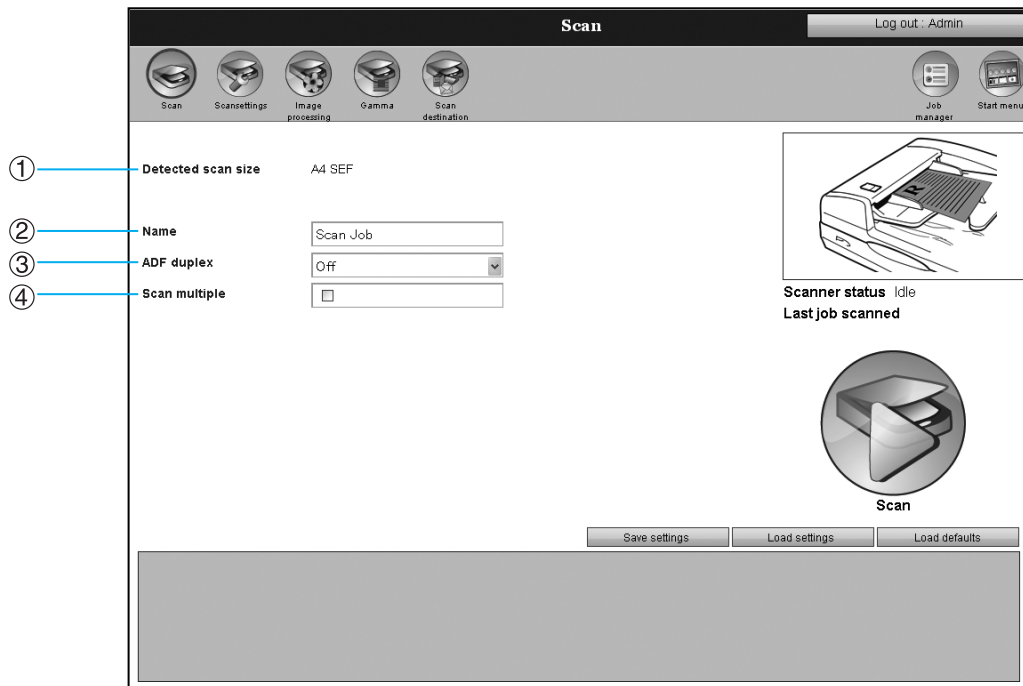

## Information displayed / Settings

### 1) Detected scan size

Displays the size and orientation of the original set on the platen glass of the scanner or in the auto feeder.

### 2) Name

Names the scan job. (Max. 255 characters using alphanumeric characters and symbols (character strings that can be entered on the Touch Panel Display))  
 Touch the text input area, and enter the name of the job in the text input screen.  
 For instructions on how to enter text, see "Text Input Method". p.92

### 3) ADF duplex

Specifies the finishing side to scan duplex originals using the auto feeder.

### 4) Scan multiple

Place a checkmark to scan originals multiple times. When a checkmark is placed in the **[Scan multiple]**, the following screen is displayed and the scanner goes on standby for 90 seconds at the end of scanning of originals that were set after the start of copying.

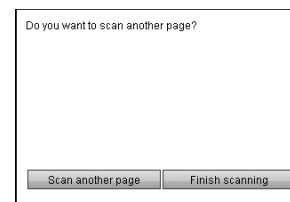

**[Scan another page]:** When touched after an original is set, the scanning of next original starts.

**[Finish scanning]:** Ends scanning.



## Scan settings

This screen is for setting up original scanning by the scanner.



### Information displayed / Settings

#### 1) Resolution (dpi)

Sets the image quality (resolution).  
Settings: 200x200 dpi, Standard (300x300 dpi),  
400x400 dpi, 600x600 dpi

#### 2) Detected scan size

Displays the size and orientation of the original set on the platen glass of the scanner or in the auto feeder.

#### 3) Scan size

Selects the size of image to be scanned by the scanner.

#### 4) Zoom

Sets the enlargement / reduction rate for printing.  
Selects a fixed magnification from the combo box on the left side. The magnification (%) can also be entered by touching the number input area on the right side and using the numeric keypad.

#### Note:

- For the details of setting items, refer to the separate manual, "ComColorExpress IS700C Printer Driver Guide".

## Image processing

This screen is for setting up image scanning.

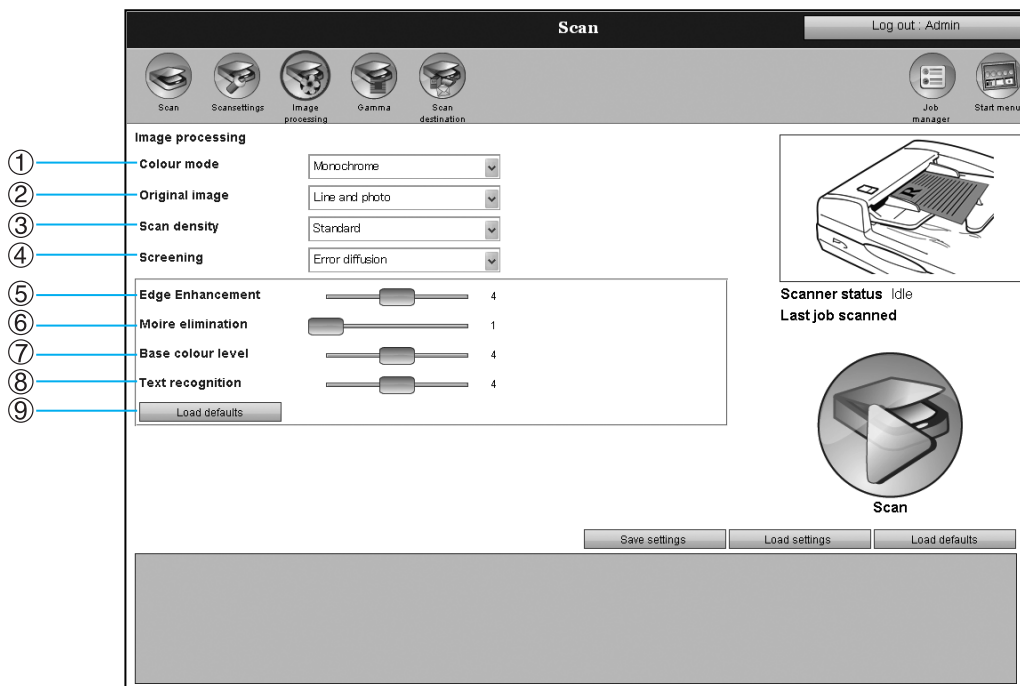

### Settings

#### 1) Colour mode

Select the colour mode of scanned data from RGB, Grey scale, and Monochrome.

#### 2) Original image

Select the appropriate mode for the type of original (Line / Photo / Line and photo).

#### 3) Scan density

Select the scan density (Light / Standard / Dark) according to the conditions of originals.

#### 4) Screening

Select the halftone processing method (Error diffusion / Dot window (70 lpi) / Dot window (100 lpi)).

#### 5) Edge Enhancement

Adjusts edge enhancement for characters and illustration from seven levels.

#### 6) Moire elimination

Adjusts moire elimination from seven levels.

#### 7) Base colour level

Adjusts scan processing not to scan the base and the back of originals from seven levels.

#### 8) Text recognition

Adjusts scan processing to distinguish character areas and image areas from seven levels.

#### 9) Load defaults

Loads the default settings for [Edge Enhancement], [Moire elimination], [Base colour level], and [Text recognition].

#### Note:

- [Edge Enhancement], [Moire elimination], [Base colour level], [Text recognition], and [Load defaults] are available when [Colour mode] is set to [Monochrome].

## Gamma

This screen is for adjusting the gamma of scanned images.

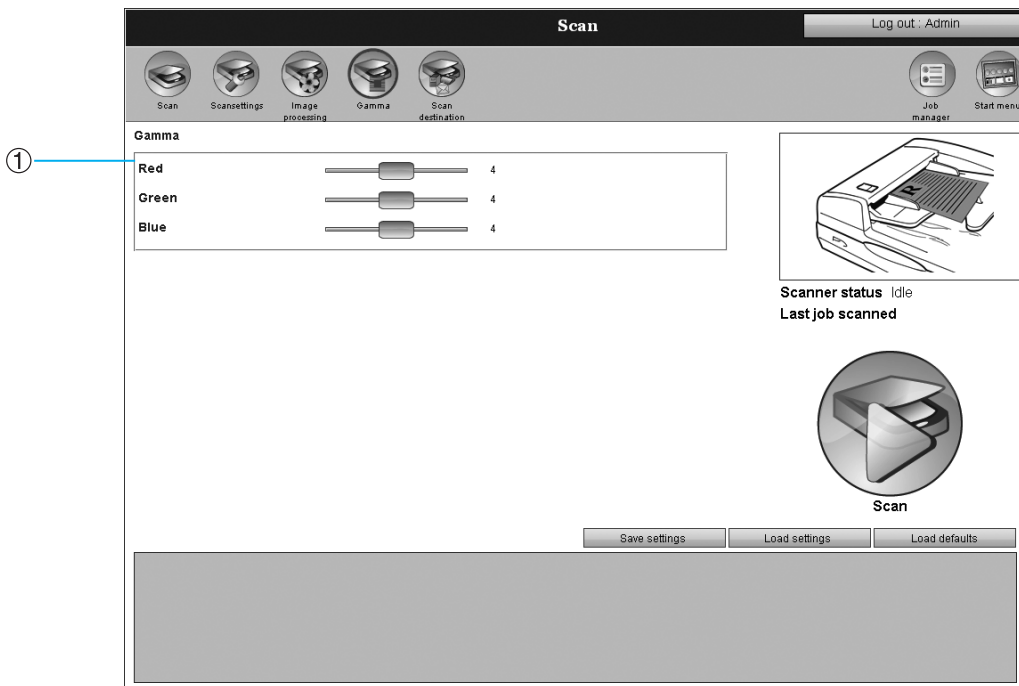

### Setting

#### 1) Gamma adjustment of colours

Adjust the gamma of colours.

When the **[Colour mode]** setting on the **[Image processing]** screen is **[RGB]**, the gamma adjustment is made for **[Red]**, **[Green]**, and **[Blue]**. When the setting is **[Grey]** or **[Monochrome]**, the gamma adjustment is made for **[Black]**. Setting a high gamma level value makes the colour darker, while setting a lower value makes the colour lighter.

## Scan Destination

This screen is for setting the destination of scanned data.

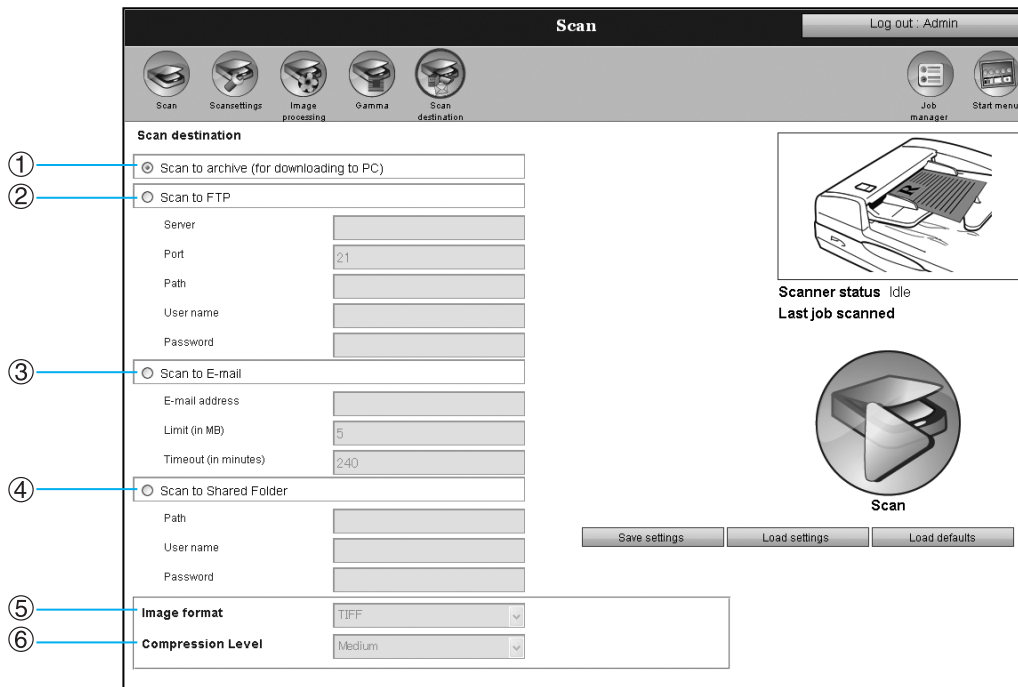

### Settings

#### 1) Scan to archive (for downloading to PC)

Saves the scanned data as a scan job (archived job) in the scan job list of the print controller. The scanned data can be imported to a computer using the “feedback” function of the RISO Console.

“Downloading Archived Jobs to the Computer” p.36

#### 2) Scan to FTP

Server: FTP server name or IP address  
 Port: Port number to access the FTP server (normally “21”)  
 Path: Directory in the FTP server where to send the file  
 User name: User name for accessing the FTP server  
 Password: Password for accessing the FTP server

#### Note:

- For setting information concerning the destination FTP server, confirm with the administrator of the FTP server.

#### 3) Scan to E-mail

Sends scanned data using the e-mail function. Enter the following items.

E-mail address: E-mail address of the destination  
 Limit (in MB): The maximum data size that can be attached to an e-mail

When the capacity of scanned data exceeds the specified size, the file is not attached to the e-mail body, and link information is written in the file saving location of the print controller. The file can be downloaded as many times if it is within the time set in **[Timeout (in minutes)]**. (When the time-out period elapses, the file is automatically deleted.)

When “0” is entered, the data is not divided up for e-mail attachment.

Timeout (in minutes): Specify the time (minute) of temporary storage when the scanned data has not been sent due to error, etc.

To use e-mail notification, set **[Mail server]** and **[Sender address]** in **[Communication settings]** in advance.

p.47

#### 4) Scan to Shared Folder

Stores the scanned data in a shared folder. Enter the following items.

Path: Path to the destination shared folder

\\ (computer name) \ (drive name) \ (folder name)

User name: User name for accessing the shared folder

Password: Password for accessing the shared folder

#### Note:

- For settings concerning the destination shared folder, confirm with the administrator of the shared folder.

#### 5) Image format

Select the file format of the scanned data.

Settings: TIFF, PDF, PNG, JPEG

#### 6) Compression Level

Select the compressibility of the scanned data.

Settings: Lowest, Low, Medium, High, Highest

## Management of Scanned Jobs

Scanned data is sent to the destination specified on the **[Scan destination]** screen.

When **[Scan to archive]** is selected, the information of the scan job is displayed on the job manager screen.

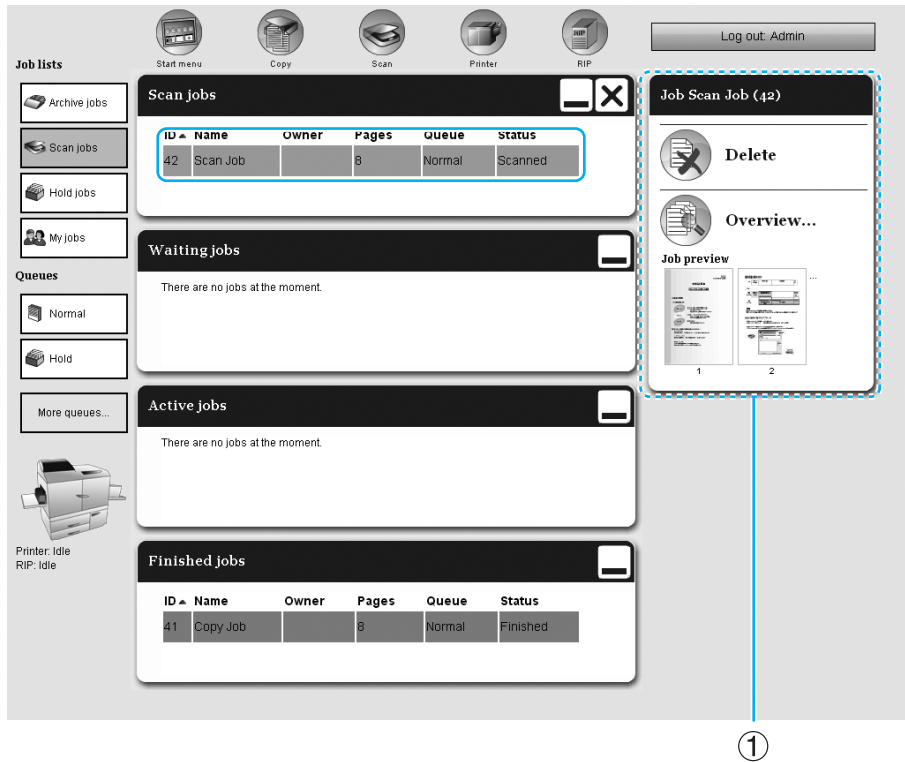

When a job is select on the job list, icons are displayed of operable functions (1) on the right side of the screen.

### Note:

- The functions and the operation methods are the same as the RISO Console.  
For details, see “Jobs (Job manager)”. [p.14](#)

## Rebooting / Shutting Down the Print Controller

When you touch the  icon of the print status on the start menu, the following screen is displayed.



The **[RIP reboot]** reboots the print controller.

The **[RIP shutdown]** turns off the print controller.

To close the screen without rebooting or shutting down, touch **[Cancel]** or .



# Appendix

## Troubleshooting

This section describes displayed information and solutions for troubles and errors displayed on the Touch Panel Display while operating the print controller and the RISO Console.

Trouble	Cause and solution
The RISO Console does not start.	The "RIP Name" or "IP address" has not been correctly entered into the URL input area.
The print results are different from the settings in the printer driver.	In the queue of the print controller through which original data has been sent, the "queue priority" is set to "on". When you want to prioritize the settings of the printer driver, either change the processing settings of the queue (administrator setting) or select a different queue before executing the print operation.
The job you have sent cannot be cancelled, deleted, or edited in the job manager.	The job manager has been used without logging in or was logged into with an ID that is different from the owner of the job. Log in with the correct ID.
You cannot conduct the operation even when you touch the Touch Panel Display.	The reacting positions of the Touch Panel Display have not been correct. Calibrate the Touch Panel Display. <a href="#">☞ p.87</a>



---

## Error screen of the Touch Panel Display (Option)

---

If a transfer error occurs in the printer, the location of the error is displayed on the Touch Panel Display. Solve the problem that has caused the error by referring to the display on the screen.

**Note:**

- While the screensaver is active, the error screen is not displayed until the Touch Panel Display is touched.

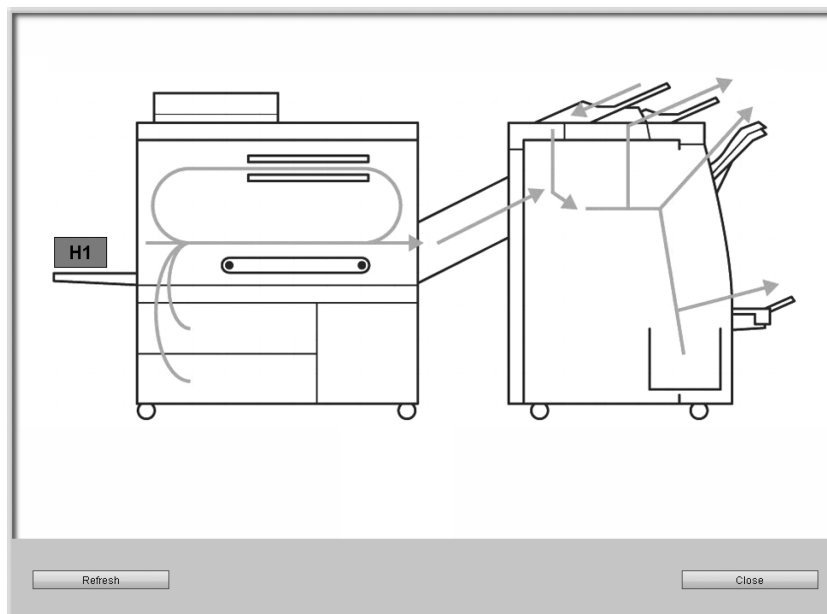

After having solved the problem, touch **[Refresh]** to check if the error has been cancelled. When you have solved the problem that caused the error, touch **[Close]** to return to the Start menu.

# Index

## A

Account Information .....	66
Administrator .....	8, 44
Archived jobs .....	31

## B

Backup .....	58
--------------	----

## C

Calibrating the Touch Panel Display .....	87
Cancelling a Job .....	17
Changing Detailed Settings of Queues .....	71
Changing Passwords .....	48
Colour calibration .....	63
Console Screen .....	6
Controller screen .....	94
Copy Functions .....	95
Copying a Job .....	15
Create new queue .....	69
Creating Archived Jobs .....	31
Custom forms .....	60
Custom paper sizes .....	61
Custom Queue .....	69

## D

Deleting a Job .....	16
Deleting Custom Queues .....	70
Detailed Settings of the Print Controller .....	45
Downloading Archived Jobs .....	36
Downloading Archived Jobs to the Computer .....	36

## E

Editing a Job .....	19
Editing Archived Jobs .....	32
Event log .....	52, 68

## G

General user .....	8
Guest user .....	8

## H

Hold queue .....	10
------------------	----

## J

Job delegation .....	54
Job Display Order .....	17
Job manager .....	14, 93
Job ownership .....	14
Job Preview .....	18
Job settings .....	50

## L

Login .....	8, 44, 89
Login ID .....	49

## M

Merging Pages from Multiple Archived Jobs .....	39
Moving a Job to Another Queue .....	16

## N

Network settings .....	47
Normal queue .....	10

## O

Others can see jobs .....	49
---------------------------	----

## P

Password .....	49
PCL tray setting .....	62
Printer Status .....	41, 94
Printing a Job .....	15
Printing Archived Jobs .....	31
Profile management .....	64

## Q

Queue .....	10
-------------	----

## R

Rebooting .....	75
Registering New Users .....	49
Resuming Queue Processing .....	74
RIP Data .....	31
RISO Management Tool .....	77

## S

Scan Functions .....	101
Selecting Languages .....	8, 88
Shutting Down the Print Controller .....	75
SMAP .....	82
Stopping Queue Processing .....	74
System Events Log .....	68

## T

Time settings .....	55
Touch Panel Display .....	86
Touch panel settings .....	56

## U

User management .....	48
-----------------------	----





**Please contact following for supplies and service:**