

A series of overlapping, colorful lines (green, blue, and magenta) that form a complex, stepped geometric shape on the right side of the page, extending from the top to the bottom.

Wrapping Envelope Finisher User's Guide

A blurred, artistic image of a RISO ComColor GD Series Wrapping Envelope Finisher. The machine is shown from a low angle, with a control panel featuring a screen and buttons. The image is overlaid with a grid of blue lines and a glowing green circle.

ComColor GD Series

Model: Wrapping Envelope Finisher G10 (E) / Wrapping Envelope Finisher G10 (U)

The user is cautioned that unauthorised changes or modifications not approved could void the user's authority to operate the equipment.

NOTE: This equipment has been tested and found to comply with the limits for a Class B digital device, pursuant to part 15 of the FCC Rules. These limits are designed to provide reasonable protection against harmful interference in a residential installation. This equipment generates, uses and can radiate radio frequency energy and, if not installed and used in accordance with the instructions, may cause harmful interference to radio communications. However, there is no guarantee that interference will not occur in a particular installation. If this equipment does cause harmful interference to radio or television reception, which can be determined by turning the equipment off and on, the user is encouraged to try to correct the interference by one or more of the following measures:

- Reorient or relocate the receiving antenna.
- Increase the separation between the equipment and receiver.
- Connect the equipment into an outlet on a circuit different from that to which the receiver is connected.
- Consult the dealer or an experienced radio / TV technician for help.

CAN ICES-3 (B)/NMB-3 (B)



CAUTION

To ensure safety precautions, be sure to read this guide before using the product. After reading this guide, keep it in handy for future reference.



VORSICHT

Um Vorsichtsmasnahmen zu treffen, lesen Sie sich vor Gebrauch des Produkts das Handbuch durch. Halten Sie das Handbuch nach dem Durchlesen stets griffbereit.

About This Guide

Prefaces

Thank you for purchasing this unit.

This unit is an automatic letter sealing unit which connects to our printers to receive printed content and then seal it.

Please read this guide before using or when you have concerns while using, and make use of this product and guide long for ever.

This guide describes required information when connecting the Wrapping Envelope Finisher. For more information on the printer settings which are not related to sealed mail creation functions, see the guides of the ComColor GD Series printer.



- The models which can be connected to the Wrapping Envelope Finisher are those in the ComColor GD Series (9630 / 7330).
- In order to conduct envelope stuffing with this unit, it is necessary to install the designated printer driver shipped with the printer, and set the connection options in the environmental settings.
- To create mails with this unit, a mail making application is required to create original data for mail printing.

About This Guide

(1) This guide may not be reproduced in whole or in part without the permission of RISO KAGAKU CORPORATION.

(2) The contents of this manual may be changed without prior notice due to product improvements.

(3) RISO KAGAKU CORPORATION shall not be liable for any consequence of using this guide or the machine.

Trademark Credits

Microsoft, Windows, and Microsoft Word are either registered trademarks or trademarks of Microsoft Corporation in the United States and/or other countries.

 RISO, ComColor, and FORCEJET are trademarks or registered trademarks of RISO KAGAKU CORPORATION in the United States and other countries.

Other corporate names and/or trademarks are either registered trademarks or trademarks of each company, respectively.



Acquisition of Color Universal Design Certification

The Wrapping Envelope Finisher (this unit) is certified for being manufactured in consideration of Color Universal Design, which improves visibility for more people regardless of individual differences in color perception, by the Color Universal Design Organization (CUDO).

Symbols, Notations, and Screenshots Used in This Guide

■ Symbols Used in This Guide



Indicates cautions that should be noted for safe use of this unit.



Indicates important items that should be noted or are prohibited.



Indicates useful information or additional information.

■ Names of Keys and Buttons

The names of hard keys on the operation panel and buttons/items on the touch panel screen or computer (application) window are indicated with square brackets [].

● Operation Panel

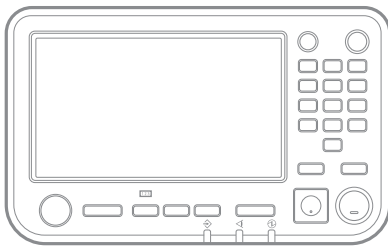

Example: Press the [Stop] key.

● Touch Panel Screen

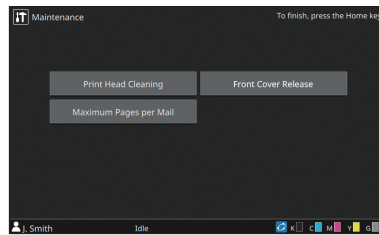

Example: Touch [Maximum Pages per Mail].

● Computer Window

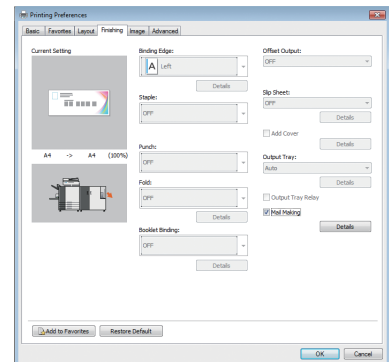

Example: Place a check mark in [Mail Making].

■ Illustrations Used in This Guide

The screenshots and illustrations contained in this guide may vary depending on the model of the unit, or the usage environment, including the connected optional equipment.

■ Reference of Names

- In this guide, "Wrapping Envelope Form A/B/C" is referred to as "Envelope form".

Contents

About This Guide	1
Symbols, Notations, and Screenshots Used in This Guide	2
Safety Precautions	5
Warning Symbols	5
Power Plug	5
Installation Location	5
Power Connection	6
Handling	7
Before Use	8
Installation Location	8
Power Connection	8
Required Spacing	9
Handling	10
Usable Paper	10
Saving Envelope Form	13
Handling of Sealed Mails	14
About Using and Handling the Storage Case	14
Part Names and Functions	15
What You Can Do with the Wrapping Envelope Finisher	16
Envelope Stuffing Function	17
Envelope Stuffing Method	17
Envelope Form Structure	17
Terms	18
Original Data Structure of "Mails"	19
Paper Feed Path	19
Creating Original Data for Mail Printing	20
Printable Area	22
Preparations Prior to Creating Mail	24
Power	24
Unit Status	24
Loading the Envelope Form	25
Setting Paper Guides	28
Checking the Amount of Water	30
Chapter 1 Mail Making	1-1
Basic Operations	1-2
Settings for the Printer Driver	1-3



Setting the Printer Configuration	1-3
[Finishing] Tab	1-3
Operating the Mail Making Jobs	1-7
Changing the Setting During Printing	1-7
Changing the Settings of a Waiting Job	1-8
Setting the Mail Making Functions	1-8
Admin Menu Settings	1-10
Envelope Form Setting Guide	1-10
Chapter 2 Maintenance	2-1
Refilling the Water Supply Tank	2-2
Supplying Water	2-2
Troubleshooting	2-4
Precautions When Removing Jammed Paper	2-10
Chapter 3 Appendix	3-1
Specifications	3-2
Consumables	3-6
Consumable Items	3-6
Index	3-7
Vorsichtsmaßnahmen	3-10
Warnsymbole	3-10
Netzstecker	3-11
Aufstellungsort	3-11
Netzanschluss	3-11
Behandlung	3-12
Vor Inbetriebnahme	3-13
Aufstellungsort	3-13
Netzanschluss	3-13
Abmessungen	3-14
Behandlung	3-15
Verwendbares Papier	3-15
Aufbewahren der Umschlagformen	3-18
Handhaben von versiegelten Mails	3-19
Hinweise zur Verwendung und Lagerung des Aufbewahrungsbehälters	3-19
Technische Daten	3-20

Safety Precautions





This section describes the items that should be followed for safe use of this unit. Be sure to read this section before using the unit.

Warning Symbols

To use the unit properly and to prevent human injury and damage to properties, the following warning symbols are used. Read the meaning of the symbols to understand and then read this guide.

 WARNING	Indicates that incorrect handling by ignoring this symbol may cause death or serious human injury.
 CAUTION	Indicates that incorrect handling by ignoring this symbol may cause human injury or damage to properties.

Examples of symbols

	The  symbol indicates a prohibited action. A specific prohibited action is drawn inside or next to the symbol. (The left figure indicates that disassembly is prohibited.)
	The  symbol indicates a forced action or an instruction. A specific instruction is drawn inside the symbol. (The left figure indicates an instruction to remove the power plug from the electrical outlet.)

Power Plug

- In addition to this unit, printers and optional devices connected to the printer also have power plugs.



Installation Location

CAUTION

- Place the unit on a flat or stable surface. Otherwise, the unit might be inclined or fall down, resulting in human injury.
- Do not place the unit in a dusty or humid location. Otherwise, a fire or an electric shock might occur.

Power Connection

WARNING



- Use this unit with the rated voltage. Use a power source with a sufficient margin. Otherwise, a fire or an electric shock might occur.
- Install the unit near the wall socket to avoid using an extension cord between the unit and the wall socket. If an extension cord is absolutely required, do not use longer than 5m (15ft). Otherwise, a fire or an electric shock might occur. 
- Do not damage or rebuild the power cord. Placing a heavy object on the cord or pulling or forcibly bending the cord may damage the cord, resulting in a fire or an electric shock. 
- The power cord supplied with this product can be used only for this unit. Do not use it for another electric product. Otherwise, a fire or an electric shock might occur.
- Do not plug or unplug the power cord if your hands are wet. Otherwise, an electric shock might occur.

CAUTION

- Connect the plug securely to the optional connection outlet on the printer main unit to avoid a loose connection.
- Do not pull the power cord when unplugging it. Otherwise, it could become damaged and a fire or an electric shock might occur. Be sure to hold on to the plug when unplugging the power cord.
- If the unit will not be used for a long time, such as during a holiday, unplug the power cord from the electrical outlet for safety.
- Pull out the power plug from the electrical outlet at least once a year and clean the prongs of the plug and their surroundings. Dust collected on these areas can result in fire.

Handling

WARNING

- Do not place water containers or metallic objects on the unit. If water drips inside the unit or a metallic object drops inside it, a fire or an electric shock might occur.
- Do not remove the covers. Otherwise, you might be electrically shocked by the high-voltage part inside. 
- Do not disassemble or rebuild the unit by yourself. Otherwise, a fire or an electric shock might occur.
- Do not insert or drop any metallic material or flammable substances into the unit through any opening. Otherwise, a fire or an electric shock might occur.
- When supplying or draining water, be careful not to spill water into the interior of the unit. Otherwise, a fire or an electric shock might occur.
- If something falls inside the unit, immediately hold down the [Power] key  on the operation panel, turn off the operating power, and then turn off the main power switch. Next, unplug all of the power cords and contact your dealer or authorized service representative. Continued use might result in a fire or an electric shock.
- In the unlikely event that the unit continues to be used while emitting excessive heat, smoke, or a foul odor, a fire or an electric shock might occur. Immediately hold down the [Power] key on the operation panel, turn off the operating power, and then turn off the main power switch. Next, be sure to unplug all of the power cords and contact your dealer or authorized service representative. 

CAUTION

- Do not insert your fingers or other objects into the gap around the mail stacker. Failure to do so may cause injury.
- Be careful of protruding parts and metal terminals when performing maintenance inside the printer such as removing jammed paper. Failure to do so may cause injury.
- The inside of the printer may have areas with ink. Be careful not to let the ink come in contact with your hands or clothing. Should ink accidentally make contact with your hands, wash it off with detergent as soon as possible.
- When moving the unit, contact your dealer or authorized service representative. If you try to forcibly move the unit, the unit might overturn, resulting in injury.

Before Use

This section describes the precautions that must be observed before using the unit.

Installation Location

Observe the following precautions.

- **Your dealer will help you to determine a proper location for the unit at the time of delivery.**
- **When moving the unit, contact your service representative.**
- **Avoid installing the unit in the following locations. Otherwise, incorrect operation, malfunction, or accident might occur.**
 - Avoid places exposed to direct sunlight or excessive illumination such as near a window (If such is unavoidable, install curtains to cover the window.)
 - Places subject to sudden temperature variations
 - Places excessively hot and humid or cold and dry
 - Places close to fire or heat
 - Places directly subject to cold air from air conditioners or hot air from heaters, as well as radiant heat
 - Places with poor air permeability or ventilation
 - Dusty places
 - Places subject to excessive vibration
- **Install the unit in a place whose levelness is within the following specified range.**
Installation surface level: 2 degrees or less
- **Operate the unit under the following environment conditions.**
Temperature range: 15 °C - 30 °C (59 °F - 86 °F)
Humidity range: 40% - 70% RH (non-condensing)

Power Connection

Observe the following precautions.

- **Connect the plug securely to the optional connection outlet on the printer main unit to avoid a loose connection.**
- **Install the unit near an electrical outlet.**
- **When the main power switch of this unit is on, the power of the unit will turn on and off together with the power of the printer.**

Required Spacing

■ Printer and Wrapping Envelope Finisher

Provide sufficient space for the operations, replacing the consumables, and maintenance.

- As seen from the front

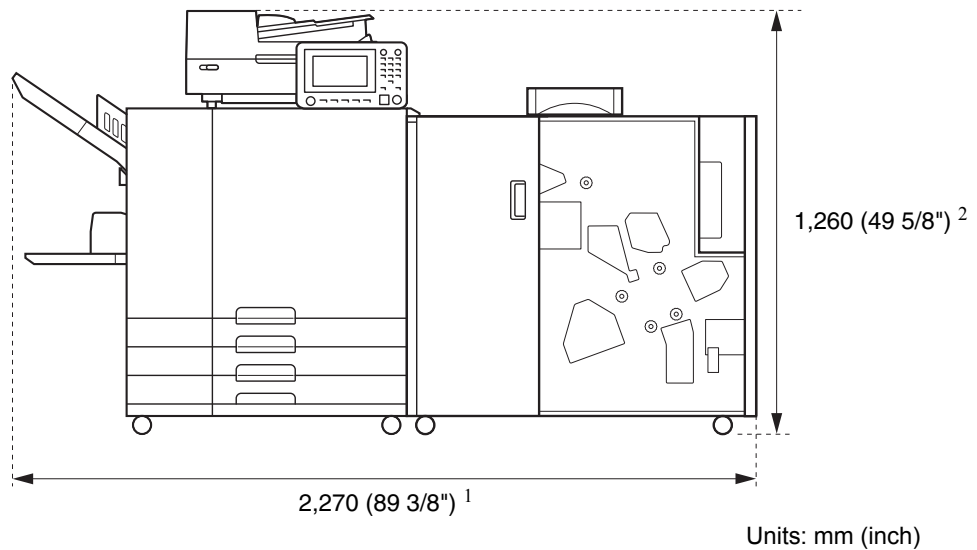

- As seen from the side

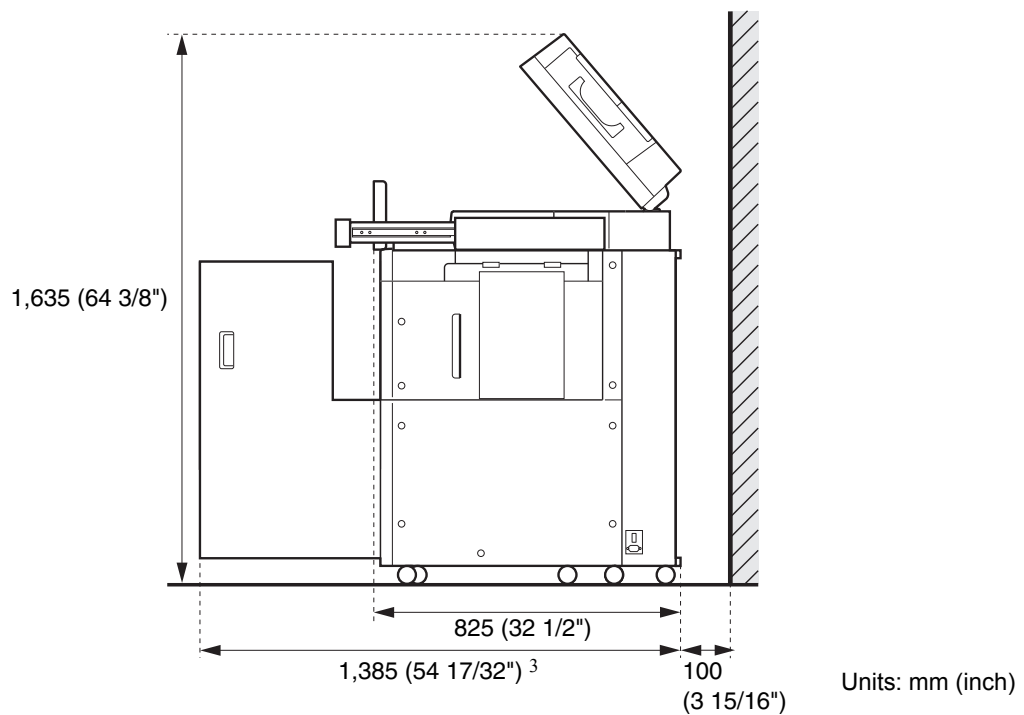

The size varies depending on the optional equipment used.

1 Width	Printer and Wrapping Envelope Finisher	2,270 mm (89 3/8")
	+ Scanner (when using scanner stand)	2,270 mm (89 3/8")
	+ Face Down Finisher	2,490 mm (98 1/32")
	+ High Capacity Feeder	2,615 mm (102 15/16")
2 Height	No options (in a state where the operation panel is upright at 90 degrees)	1,160 mm (45 21/32")
	Printer, Wrapping Envelope Finisher and Scanner (when using special scanner stand)	1,260 mm (49 5/8")
	Printer, Wrapping Envelope Finisher and Face Down Finisher	1,345 mm (52 31/32")
3 Depth	No options (in a state where the operation panel is upright at 90 degrees)	1,280 mm (50 3/8")
	+ Scanner (when using scanner stand, in a state where the operation panel is upright at 90 degrees)	1,385 mm (54 17/32")
	+ High Capacity Feeder (in a state where the operation panel is upright at 90 degrees)	1,280 mm (50 3/8")

Handling

- Do not use the main power switch to turn the printer or unit off or unplug the unit during operation.
- Do not open any of the covers during operation.
- Do not move the unit.
- The unit contains precision components and moving parts. Therefore, do not perform operations not described in the guides.
- Do not place heavy objects on the unit or subject the unit to strong shocks.
- Open and close the covers gently.
- Turn the [Power] key on the operation panel of the printer off before turning the main power off then on again.

Usable Paper

To make a mail with this unit, the envelope form and a sheet(s) for insert(s) are required.

To make an envelope with this unit, use the dedicated envelope form made by RISO. This guide describes the procedures for using the envelope form made by RISO.



- This guide describes the procedures for using the envelope form made by RISO.
- For more information on the usable paper, see the guides of the ComColor GD Series printer.

Envelope Forms Made by RISO

The types and sizes of envelope forms made by RISO which can be set are as below.

Supported Models	Wrapping Envelope Finisher G10 (E)		Wrapping Envelope Finisher G10 (U)	
Envelope Form Types	Wrapping Envelope Form A	Wrapping Envelope Form B	Wrapping Envelope Form C	
Size	233 mm × 296 mm	233 mm × 391 mm	243 mm × 296 mm (9 9/16" × 11 21/32")	
Paper Weight	Approx. 7.1 g/sheet	Approx. 9.3 g/sheet	Approx. 7.4 g/sheet (0.016-lb/sheet)	
Paper Warp	5 mm or less			
Finished Size	233 mm × 110 mm	233 mm × 158 mm	243 mm × 110 mm (9 9/16" × 4 5/16")	
Maximum Load Capacity	Feed Tray: Height up to 50 mm (1 31/32") Standard Tray: Height up to 110 mm (4 5/16") High Capacity Feeder (optional): Height up to 440 mm (17 11/32")			
Number of Enclosures* (When the size is A4/ B5/Letter)	Depends on the weight of paper used. 46 g/m ² - 59 g/m ² (12.2-lb bond - 15.7-lb bond) abt.: 6 sheets or less 60 g/m ² - 80 g/m ² (16-lb bond - 21.3-lb bond) abt.: 5 sheets or less 81 g/m ² - 100 g/m ² (21.5-lb bond - 26.6-lb bond) abt.: 4 sheets or less 101 g/m ² - 120 g/m ² (26.9-lb bond - 31.9-lb bond) abt.: 3 sheets or less			
Number of Enclosures* (When the size is Legal)	Depends on the weight of paper used. 46 g/m ² - 59 g/m ² (12.2-lb bond - 15.7-lb bond) abt.: 4 sheets or less 60 g/m ² - 80 g/m ² (16-lb bond - 21.3-lb bond) abt.: 3 sheets or less 81 g/m ² - 100 g/m ² (21.5-lb bond - 26.6-lb bond) abt.: 2 sheets or less 101 g/m ² - 120 g/m ² (26.9-lb bond - 31.9-lb bond) abt.: 1 sheet			
Size of the Enclosures Paper	A4 (210 mm × 297 mm), B5 (182 mm × 257 mm)	A4 (210 mm × 297 mm)	Letter (8 1/2" × 11")	Legal (8 1/2" × 14")
Folds of the Enclosures Paper	Inner 3-fold	2-fold	Inner 3-fold	4-fold

* The folds of the enclosure paper is automatically determined by the combination of the envelope form size and the enclosure paper size.



- It is necessary to set the number of enclosures in the [Maximum Pages per Mail] in advance. Make sure that the number of enclosures you set does not exceed the limit shown above. If it is not configured properly, the enclosures may exceed the limit and result in a paper jam. Besides, the improper setting will make the envelopes thicker, resulting in the envelopes opening just after envelopes are sealed or while envelopes are being delivered. (p. 1-8 "Maximum Pages per Mail")
- Even when the number of enclosures does not exceed the limit shown above, a paper jam may occur depending on the type of enclosure paper or printing conditions. For mail printing, confirm that no paper jams occur by a sample mail making in advance. (p. 1-5 "Make a sample mail", p. 1-9 "Sample Mail Making")

Enclosed Paper

The types and sizes of enclosure paper which can be set are as listed below.

Supported Models	Wrapping Envelope Finisher G10 (E)	Wrapping Envelope Finisher G10 (U)
Envelope Form Types	Plain paper, recycled paper	
Size	B5 (182 mm × 257 mm) A4 (210 mm × 297 mm)	Letter (8 1/2" × 11"), Legal (8 1/2" × 14")
Paper Folding (not mixed sizes)	B5 (182 mm × 257 mm): Inner 3-fold A4 (210 mm × 297 mm): 2-fold, Inner 3-fold	Letter: Inner 3-fold Legal: 4-fold
Paper Weight	Feed Tray: 52 g/m ² - 104 g/m ² (14-lb bond - 28-lb bond) Standard Tray: 46 g/m ² - 120 g/m ² (12.2-lb bond - 31.9-lb bond) High Capacity Feeder (optional): 46 g/m ² - 120 g/m ² (12.2-lb bond - 31.9-lb bond)	
Paper Warp	3 mm (1/8") or less	
Maximum Load Capacity	Feed Tray: Height up to 50 mm (1 31/32") Standard Tray: Height up to 110 mm (4 5/16") High Capacity Feeder (optional): Height up to 440 mm (17 11/32")	

Saving Envelope Form

- Maintain the usage environment and storage temperature, and use as soon as possible, keeping in mind the date of manufacture.
- It is recommended to use all the Wrapping Envelope Forms at once if you open the shrink packaging to maintain the glue strength. If some envelopes are left unused, be sure to store them with the ★mark facing up in the storage case and use all of them within a month.
- Please do not leave the Wrapping Envelope Forms exposed. The Wrapping Envelope Forms may deform and the glue strength may deteriorate due to temperature, humidity, ultraviolet rays, oxygen, ozone, dust or other factors, which may result in the Wrapping Envelope Forms becoming unable to be used.
- Avoid locations subject to direct sunlight, high temperatures, and high humidity, and store and use Wrapping Envelope Forms at a temperature ranging from 15 to 30 °C (59 - 86 °F) and a humidity ranging from 40 to 70%. If Wrapping Envelope Forms are used at 15 °C (59 °F) or lower, the remoistening glue strength may deteriorate, resulting in sealed envelopes opening. If Wrapping Envelope Forms are used at 70% or higher, they may stick together, resulting in double feeding.
- Store and use Wrapping Envelope Forms away from a heat source and in a location where the forms are not exposed to wind from an air-conditioning machine or air purifier.

- After opening the box of Wrapping Envelope Forms, be sure to close the lid of the box and store in a location that is not subject to direct sunlight.

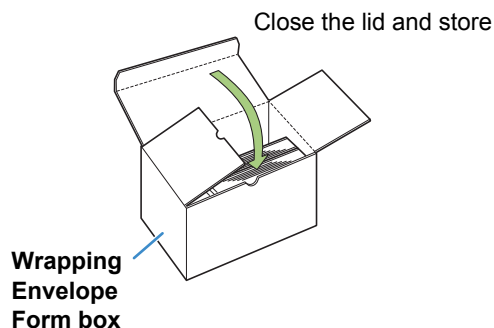

- Store Wrapping Envelope Forms whose shrink packaging has not been opened inside the box.

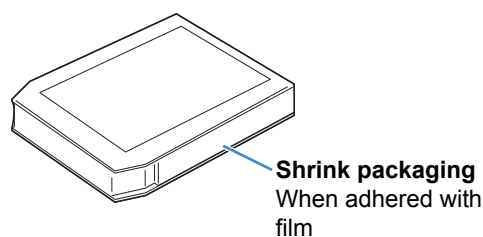

- If you want to suspend the sealing process for two hours or more, remove Wrapping Envelope Forms from the printer and store them in the storage case.

Handling of Sealed Mails

- Leaving envelopes (mail) sealed with this unit in a location that is exposed to direct sunlight may result in the envelopes opening. Promptly mail the envelopes. Be sure to check the sealing status before sending.
- Please use caution when printing and inserting confidential information with the Wrapping Envelope Finisher. RISO is not liable for opened mails, due to degradation of the sealing adhesive.
- Please use for application where it is assumed that the mail will be opened upon delivery at the destination.

About Using and Handling the Storage Case

- Use the storage case in a location where it is not exposed to direct sunlight.
- If you use Wrapping Envelope Forms stored in the storage case, create a sample by using the top form. Allow sufficient time for the flap of the envelope to dry, and check the sealing status of the pressure-sensitive glue and remoistening glue before using the rest of the Wrapping Envelope Forms. If the sample is not sufficiently sealed, the glue strength has deteriorated. Do not use the rest of the Wrapping Envelope Forms.
- To correctly manage the date when shrink packaging is opened, use caution not to mix forms that were opened at different dates in the storage case.

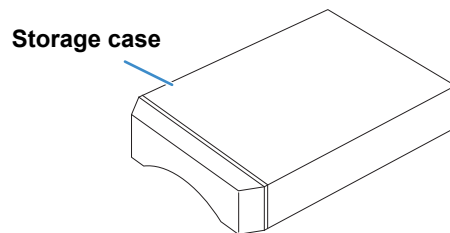

Part Names and Functions

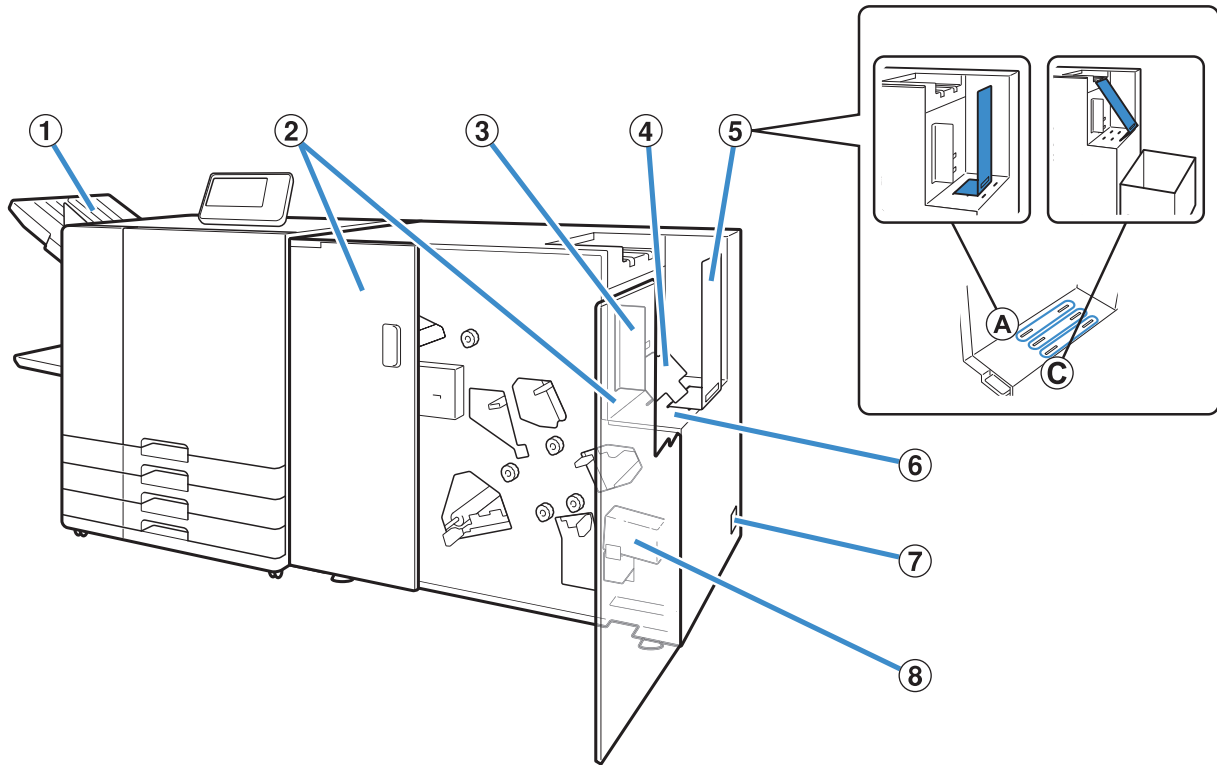

① Face Down Tray

Eject jobs other than mail creation.

② Front Cover

Open when paper is jammed, or to supply water to the water supply tank.

③ Paper Guide (side)

Protects ejected mails from crumbling.
Set a little wider than the length of the mail.

④ Bottom Plate

If the number of enclosures is small, and the loading condition is poor, set in an inclined position.

⑤ Paper Guide (end)

Insert this guide into the certain position depending on the type of envelope form.
About 110 mails can be loaded for one sheet enclosures with inner 3-fold.
When attached in the position "C" and inclined, mails can be ejected continuously.
Place a general purpose box beside the unit.

⑥ Mail Stacker

Sealed mails are ejected here.

⑦ Main Power Switch

When the main power switch is turned on, the unit will turn on and off in linkage with the power of the printer.

⑧ Water Supply Tank

Used to adhere the envelope form's remoistening glue.

What You Can Do with the Wrapping Envelope Finisher

This unit is a mail creation finisher with an automatic inline envelope stuffing system.

Utilizing the high productivity of our printers, the Wrapping Envelope Finisher supports variable output of each mail ¹.

The series of automatic operations from printing to stuffing envelopes helps you avoid mistakes under manual operations (incorrect insertion, omission, etc.). Also, cost-saving can be made through the improvement of operational efficiency by folding enclosures, stuffing and sealing envelopes automatically, which reduce working time and improve accuracy.

The number of documents to be included for each letter can be changed depending on the destination ².

In this way, a variety of mail can be created with content tailored to each customer, for direct mail, invoices, statements, event notifications, and advertising fliers etc.

- 1 Mail(s): In this guide, this refers to a unit of mail. (p. 18 "Mails")
- 2 To create original data for mail printing, a mail making application is required. Specifications may differ depending on the mail making application being used.

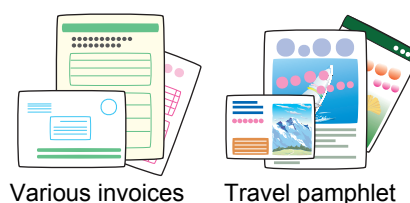

System Configuration

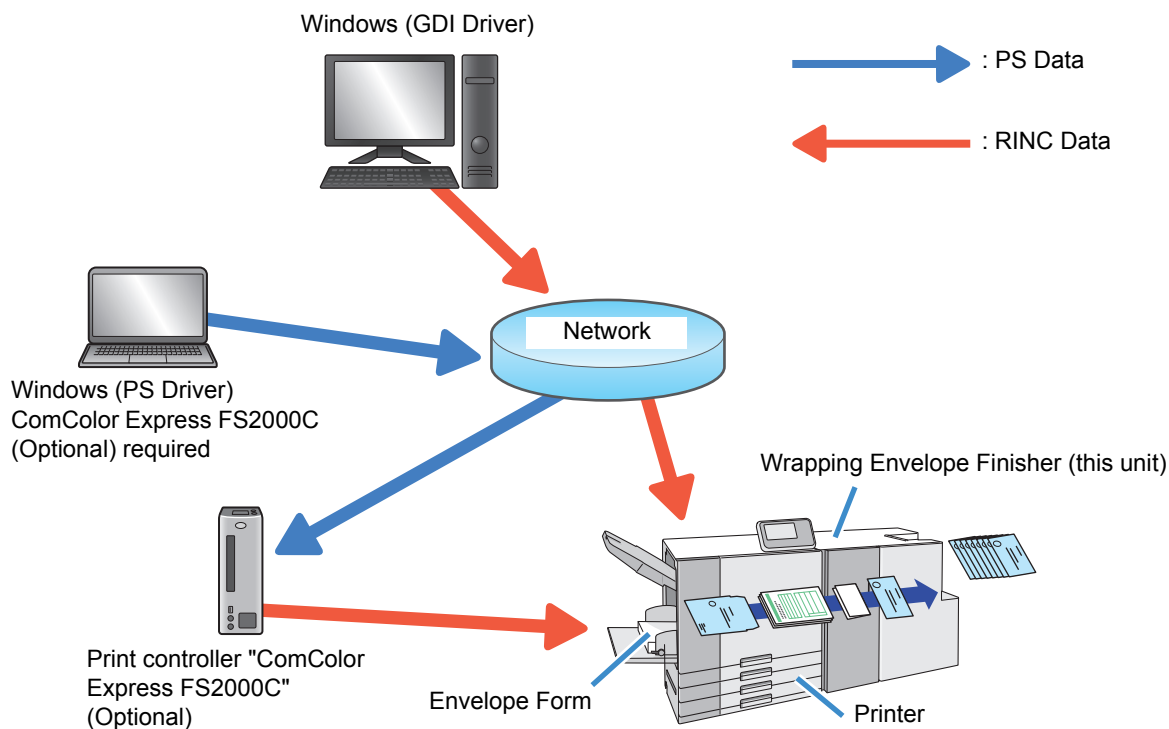

Envelope Stuffing Function

This section describes the stuffing method, terms, and construction of this unit.

Envelope Stuffing Method

Use dedicated envelope forms when creating mails with this unit.

The envelope forms are coated with pressure-sensitive glue and remoistening glue. Mail is completed by enclosing enclosures in the envelope form, folding, and then sealing.

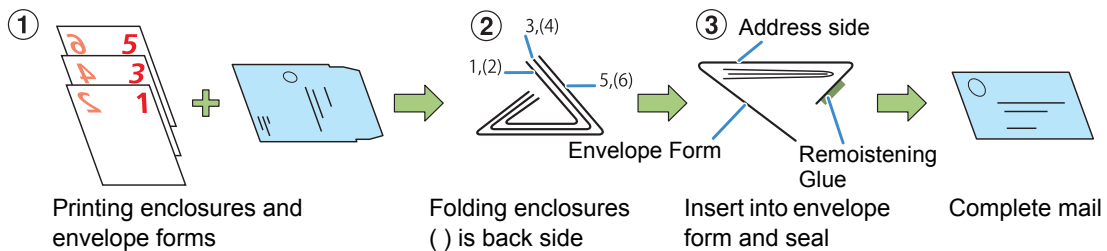

The front side can be printed without waste, depending on the use such as for notices or advertising etc. Since the back side already has a secret pattern printed on it, enclosures can include personal information such as invoices and payslips etc. without concern.

- Insert (simplex print) + Envelope form
Example) Invoices, etc.
- Insert (duplex print) + Envelope form
Example) Payslips, etc.
- Envelope form only
Example) Sales Guides etc.

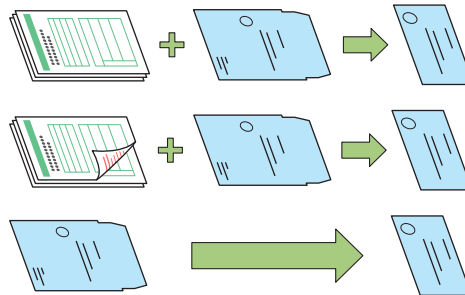

Envelope Form Structure

An envelope form is folded twice to form an envelope.

An envelope form has different marks on its front and back sides. When loading the envelope forms in the printer, make sure that they are loaded correctly by checking the marks on the front and back sides and the orientation of the flaps.

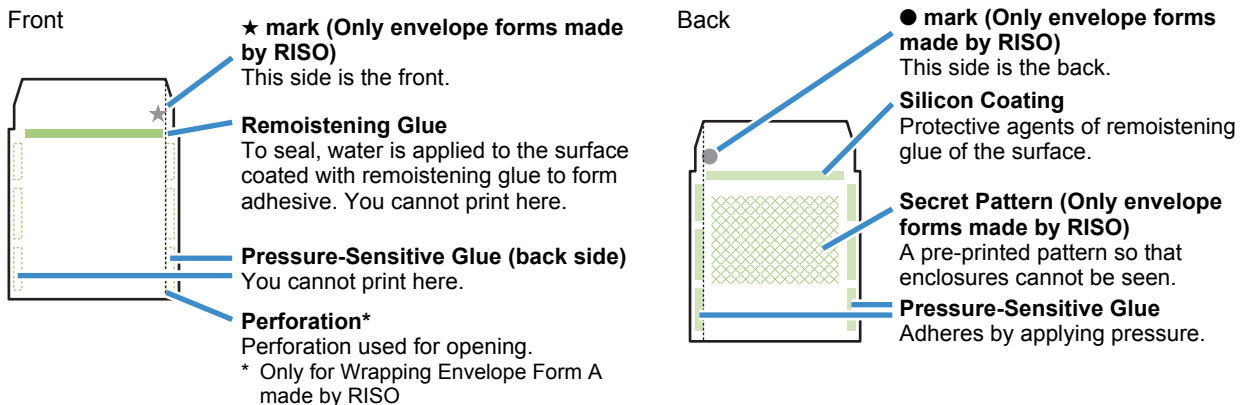

Terms

■ Mails and Jobs

In explanation of creating mail using this unit, "mails" and "jobs" are defined as follows.

Create the original in the following rules. Original data which does not follow these rules cannot be printed.

■ Mails

A unit of mails. For some applications, it is referred to as "Record".

A mail consists of an enclosure(s) and an envelope form.

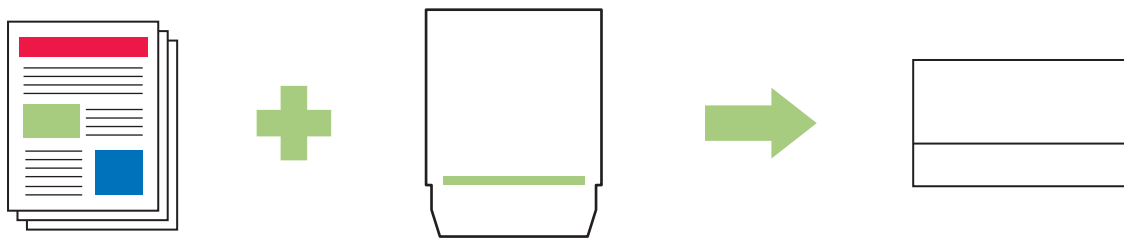

: Enclosures

- Pages created in B5 or A4 size (Letter size or Legal size) are enclosures.
- You can insert from one sheet per mail up to the number of enclosures set in "Maximum Pages per Mail" (p. 1-8) when there are enclosures.
- Enclosures can be simplex or duplex printing. When duplex printing is used when there are an odd number of pages in the original data, the last page of the enclosures will be blank.



: Envelope Form

- Register the size of the envelope form in advance. Pages created at the registered size are the originals for envelope forms.
- There is one envelope form for each mail.

■ 1 Job

This shows the collection of data for a single "mail".

When any of the following conditions are not met, "a job" cannot be printed.

Paper Size: Envelope forms are the same size for all mails in a single job. Enclosures are also the same size for a single job. The sizes of enclosures cannot be mixed.

Original Data Structure of "Mails"

To create mails with this unit, create original data structure to make the enclosures come before the envelope form. The original of the enclosures and envelope form should be created at different size.

If the data structure is incorrect, the mail cannot be printed.

For more information, see the instruction guide of the mail making application.

■ Only envelope forms (no enclosures):

Uncheck [Enclose] in [Mail Making]. Data for the envelope form in the job is made all in the same size.

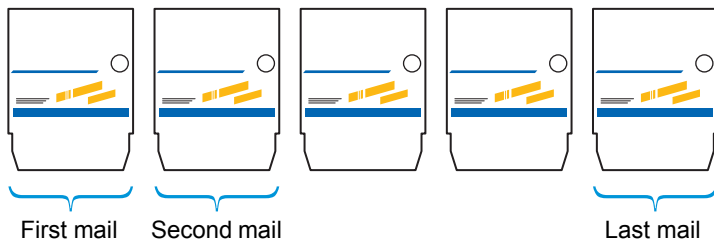

■ Enclosure data + envelope form data

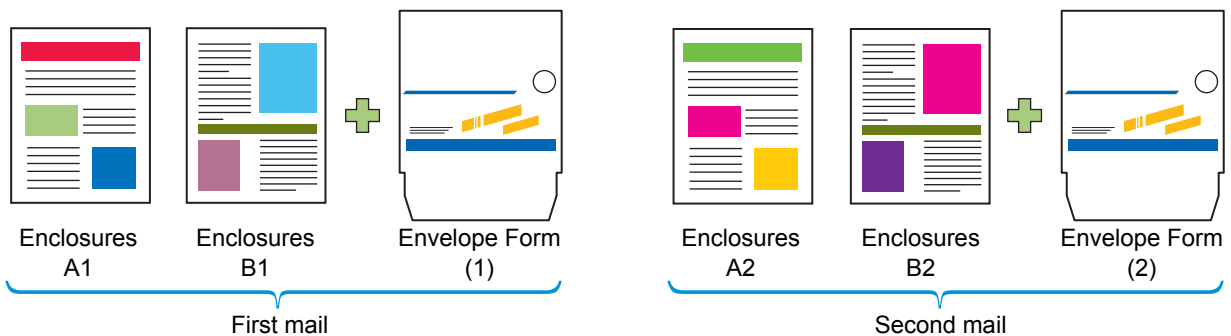

Paper Feed Path

The Wrapping Envelope Finisher feeds the envelope form and enclosures as shown below.

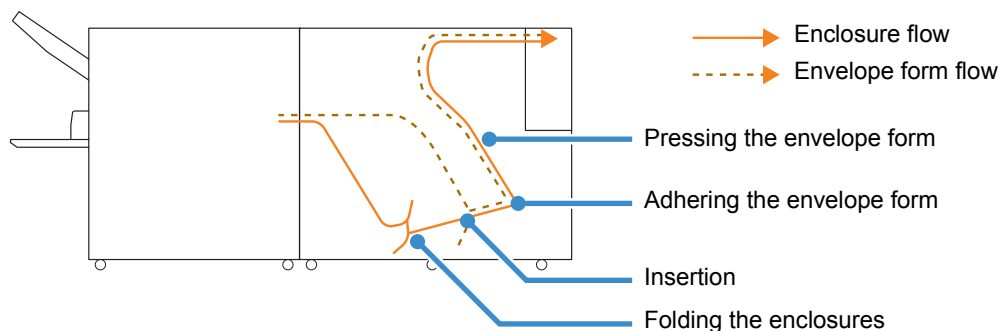

Creating Original Data for Mail Printing

Data Size for Envelope Forms

All data is made in the same size for envelope forms in a job when printing envelope forms only (with no enclosures).

For duplex printing, prepare original data for both sides of each mail and print the front first and the back second.

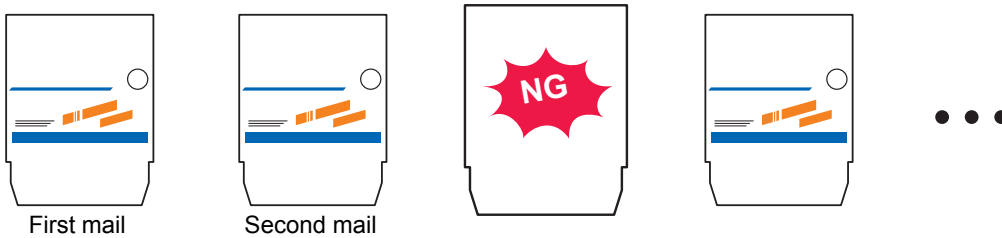

Layout of the Address Side

The layout of the address side of the envelope form differs because of the mail making application. For more information, see the instruction guide of the mail making application.

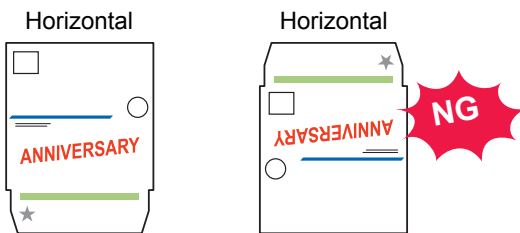

Lay the envelope form out so that the back is up, and the remoistening glue part is down.

Combinations of Enclosures and Envelope Forms

Open original data for the enclosures and original data for the envelope form by the mail making application to create original data for mail printing.

- Order the enclosure original data and envelope form original data so that they are paired together.
- Prepare one page or more for enclosure data.

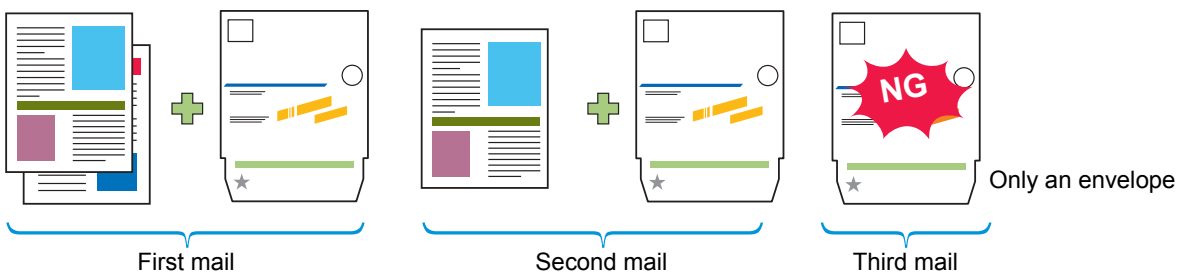

Order of Original Data

The enclosure and envelope form original data are arranged in ascending order from the first page. When printing double-sided enclosures, the front page is page 1, and the back side is page 2.

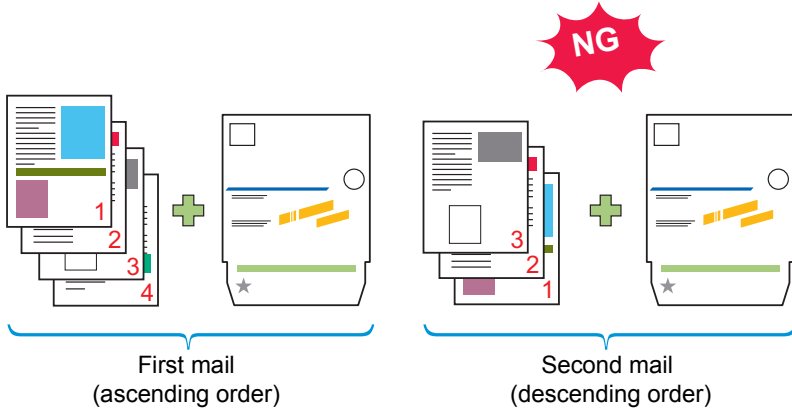

Printable Area

Envelope Form Layout

The layout of the envelope form surface is created based on the address reading direction in the mail creation application in use. Also, the area of the envelope form which can be printed on is limited. Before creating mails, for example, make a proof copy and align it with the envelope form to check the orientation and print position.

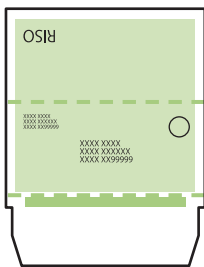

Printable area

Creates vertical originals.

When folding the envelope form into the envelope form, lay it out so that the back is up, and the remoistening glue part is down. On the back side, the characters are read in reverse.

Enclosure Layout

Some areas around the edges of the paper cannot be printed regardless of the data size of the original. The size of the blank margin left by the edges of the paper (where printing is not possible) varies depending on the model.

The margin is from 1 mm (3/64") to 3 mm (1/8").

For more information, see the guides of the ComColor GD Series printer.

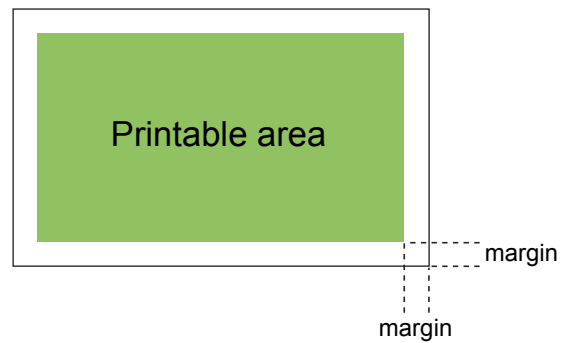

Printable Area of the Envelope Forms

The area you can print will differ depending on the envelope form type that you want to use. The printable area is as follows.

■ Printable area

■ Remoistening glue part

⋯⋯ Perforation*

Perforation used for opening.

* Only for Wrapping Envelope Form A made by RISO

Envelope form type	Front side
Wrapping Envelope Form A made by RISO	
Wrapping Envelope Form B made by RISO	
Wrapping Envelope Form C made by RISO	



- Printing will not stop even if the envelope form is set in the incorrect direction. Also, if the direction is set incorrectly, the printable area will shift, which may result in the print image extending beyond the envelope form, contaminating the conveying roller. Check the envelope form direction before printing.
- If the front and back of the envelope form are set incorrectly adhesion is not possible.
- Do not print on the remoistening glue part or the pressure-sensitive glue part. Printing on the adhesive parts will result in poor adhesion.

Preparations Prior to Creating Mail

Before mail making, make the Wrapping Envelope Finisher ready for use.



- When the main power switch of the Wrapping Envelope Finisher is off, the power of the Wrapping Envelope Finisher will not automatically turn on even if a mail making job is sent. Manually turn the main power switch on before use.

Power

The main power switch of this unit is at the bottom of the right side. When the main power switch is turned on, the unit will turn on and off in linkage with the power of the printer.

Turning On the Power

1 Make sure that the operating power of the printer is off.

When the operating power is off, the [Power] key on the printer's operation panel will not be lit.

Keep the main power of the printer on.

2 Turn on the Wrapping Envelope Finisher's main power switch.

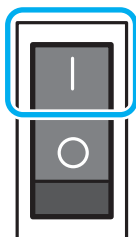

3 Press the [Power] key on the printer's operation panel.

Turning Off the Power

1 Make sure that the operating power of the printer is off.

Keep the main power of the printer on.

2 Turn off the Wrapping Envelope Finisher's main power switch.

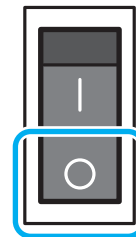

- When the main power of the Wrapping Envelope Finisher is off, the functions of the Wrapping Envelope Finisher cannot be used on the printer. Also, the functions and illustration of the Wrapping Envelope Finisher are not displayed on the operation panel and RISO Console.

Unit Status

Confirm the status of the Wrapping Envelope Finisher and the printer. In order to create a mail, the power of the Wrapping Envelope Finisher must be on.

Loading the Envelope Form

Load the envelope form in the printer feed trays and the standard tray.

- 
 • For more information on the setting of enclosure paper, see the guides of the ComColor GD Series printer.
- The envelope form is coated with adhesive. Depending on the storage environment, envelope form may stick together and may be double fed when feeding into the unit. Fan envelope form well before using.
- When setting into a high capacity feeder (optional), set in the same direction as when setting into the standard tray. For more information, see the guides of the ComColor GD Series printer.
- Depending on the printer driver [Duplex print (Enclosures)], the direction of the envelope form setting differs. If the envelope form is not set correctly, the transporting rollers may become contaminated. Also, the envelope form will not be able to be sealed.

Loading into the Feed Trays

1 Pull a tray out, toward the front.

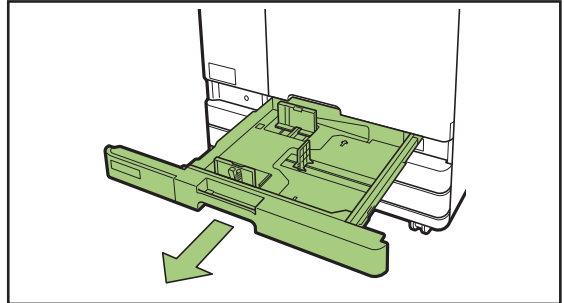

2 While pinching on the lever of the fence, pull towards the front until the tray stops to expand the fence.

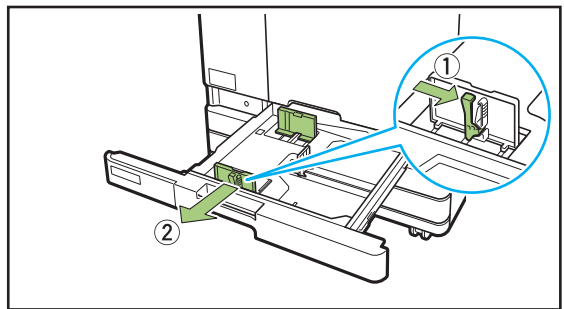

3 Expand the Stopper.

Hold the stopper from both sides and move it out of the way.

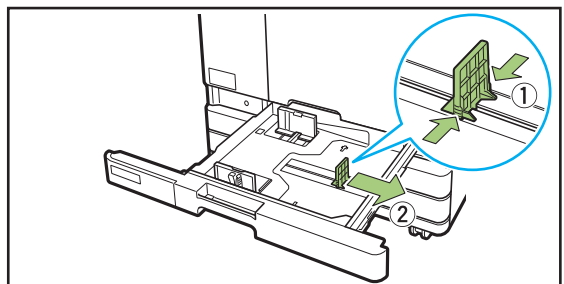

4 Load the envelope form.

Check the marks on the front and back sides of the envelope form and the orientation of the flaps, and set so as to not exceed the upper height limit of the sticker.

Set the envelope form so that its edges do not touch the guides and get bent.

■ Simplex printing of enclosures

Set the envelope form face down, so that the flap is on the left hand side of the feed tray.

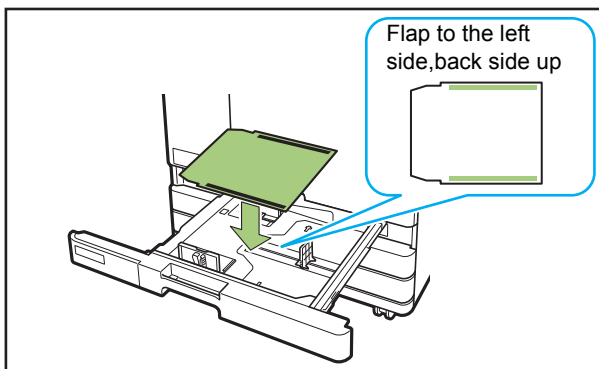

■ Duplex printing of enclosures

Set the envelope form face up, so that the flap is on the right hand side of the feed tray.

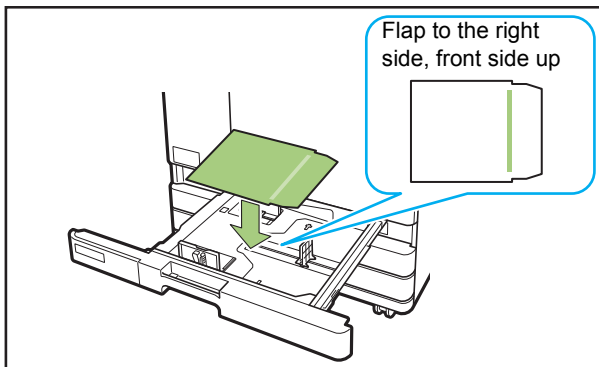

5 Move the guides and stopper against the edges of the envelope form.

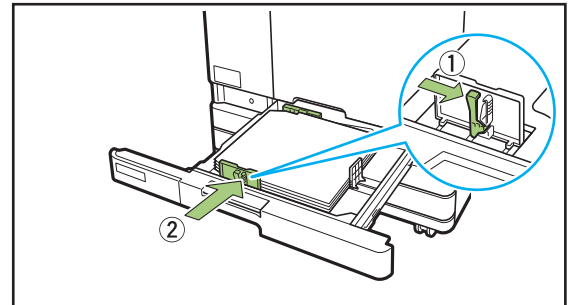

- The unit determines the size of the envelope form based on the stopper position. Be sure to move the stopper against the edge of the paper.

6 Push the tray back into the unit.

7 On the operation panel, change the feed tray settings.

Select the tray to which the envelope forms are loaded from [Paper Selection] to change the tray settings (paper size and type).

For more information, see the guides of the ComColor GD Series printer.

- Set the following items for the tray to which the envelope forms are loaded.
 - [Paper size]
Set the paper size of the envelope forms loaded to the tray.
 - [Paper type]
IJ paper
 - [Feed ctrl.]
Standard

Loading into the Standard Tray

1 Open the standard tray until it stops.

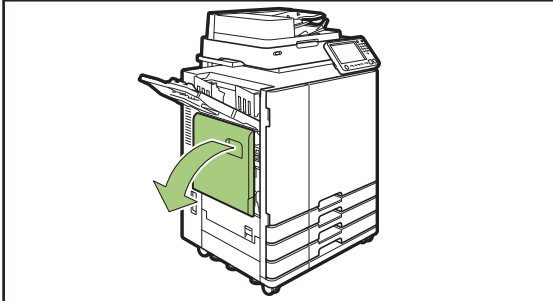

2 Spread the guides.

Set the paper feed guide levers (in two positions on both sides) to unlock the guides and slide the guides.

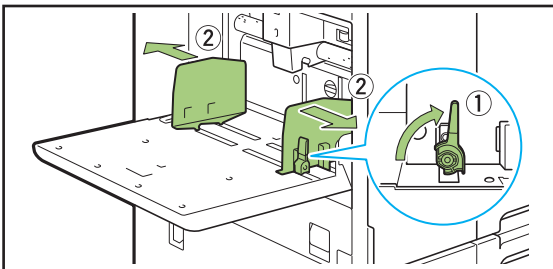

3 Load the envelope form.

■ Simplex printing of enclosures

Set the envelope form facing up, with the flap is on the right side (pick-up roller side) of the standard tray.

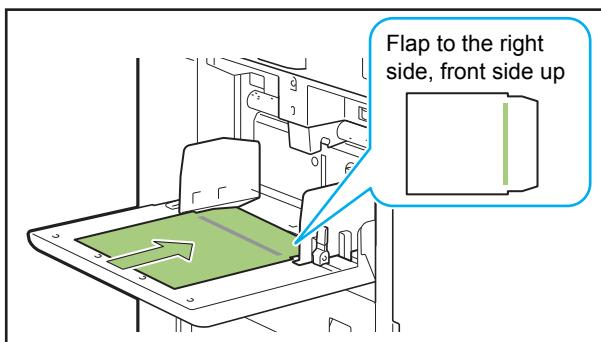

■ Duplex printing of enclosures

Set the envelope form facing down, with the flap is on the left side of the standard tray.

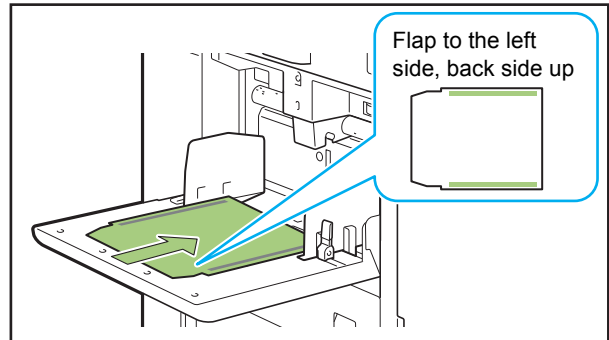

4 Move the guides against the edges of the envelope form, and push the lever to lock.

Slide the guides so that they fit the width of the envelope form, and lock the paper feed guide levers to fix the guide in place.

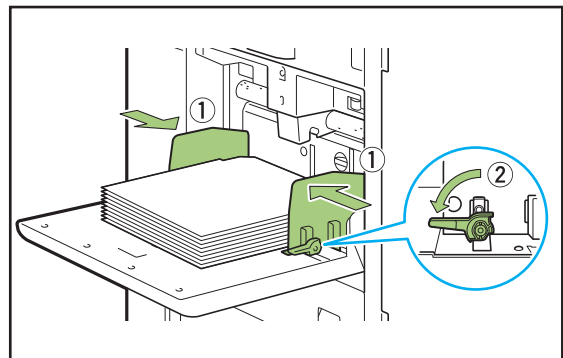

5 Set the paper feed pressure adjustment lever to "Standard".

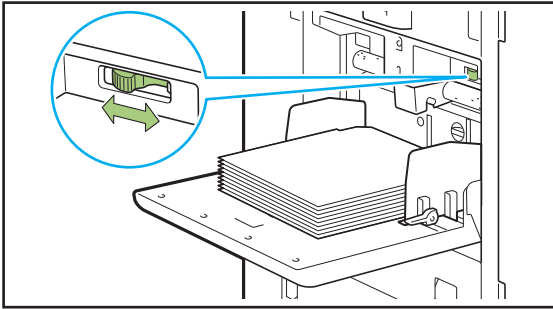

6 On the operation panel, change the feed tray settings.

Select the tray to which the envelope forms are loaded from [Paper Selection] to change the tray settings (paper size and type).

For more information, see the guides of the ComColor GD Series printer.



• Set the following items for the tray to which the envelope forms are loaded.

- [Paper size]
Set the paper size of the envelope forms loaded to the tray.
- [Paper type]
IJ paper
- [Feed ctrl.]
Standard

Setting Paper Guides

Set the unit's paper guides.

You can change the position (angle) of the guide based on the amount of mail to be created.

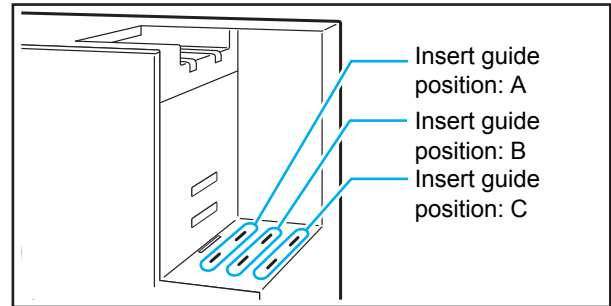

■ For stacking output

Ejected mail is stacked vertically.

The printing stops when the mail stacker is full of mails.

Remove the mails and press the [Start] key on the printer to resume printing.

1 Set the paper guide (end).

Insert the paper guide into the certain position depending on the type (size) of envelope form.

(Position A): When using Wrapping Envelope Form A or C made by RISO

(Position B): When using Wrapping Envelope Form B made by RISO

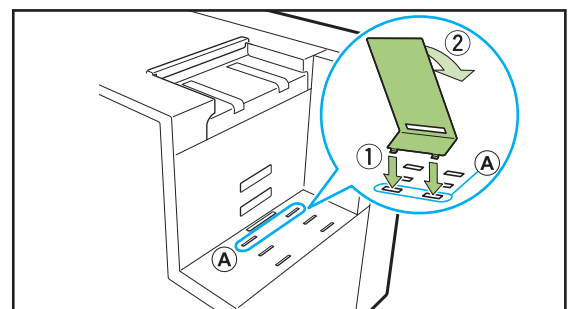

2 Set the bottom plate.

Hook the tab side of the bottom plate into the holes (central) in the side of the mail stacker, and place the another side on the paper guide (end). Change the set position based on the amount of mail.

(Lowest position): For large number of enclosures

(Highest position): For 1-2 enclosures

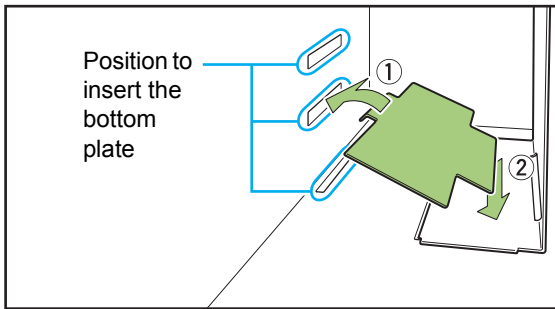

3 Set the paper guide (side).

Set slightly wider than the length of the envelope form.

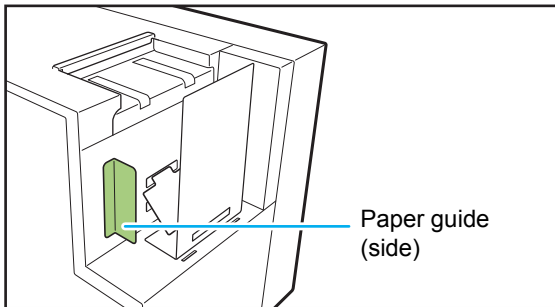

■ For free output

Mail is ejected directly into a general purpose box (cardboard box etc.).

1 Set the paper guide (end) at an angle.

Insert into position "C" and set at a tilt.

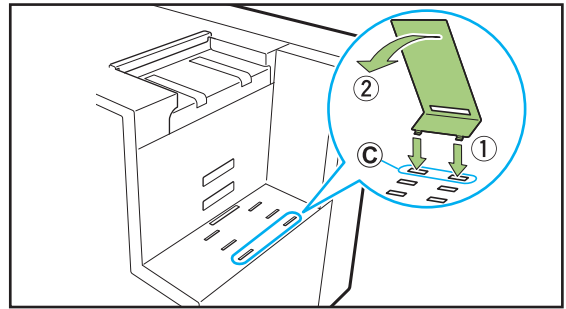

2 Set the box.

Place a general purpose box directly next to the unit, and open the lid.

Ejected mail slides along the paper guide (end) into the box.

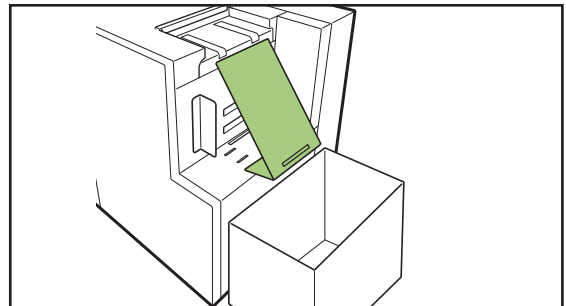

- The RISO Console can be used to check the state of the unit's paper guide (end) remotely. For more information on how to start the RISO Console, and for login procedures etc, see the guides of the ComColor GD Series printer.

Checking the Amount of Water

Use water to adhere the remoistening glue part of the envelope form. Before use, check that there is sufficient water in the water supply tank.

For more information on how to refill the water supply tank, see "Refilling the Water Supply Tank" (p. 2-2).



- When water is supplied after the water shortage error is displayed, or if the unit has not been used for a long time, note that it may take a few minutes for water to penetrate to the wetting pads.
- When the water level becomes low during operation, an error is displayed on the printer operation panel. Follow the onscreen instruction to refill the water supply tank.

Mail Making

This section describes the flow of operations of mail making and the setting items, operations of mail making jobs, and Admin Menu settings.

Basic Operations.....p. 1-2

This section describes the flow of mail making.

Settings for the Printer Driver.....p. 1-3

This section describes the setting items for the printer driver.

Operating the Mail Making Jobsp. 1-7

This section describes how to pause and change the settings of a mail making job.

Admin Menu Settingsp. 1-10

This section describes the settings related to mail making in the administrator menu.



Basic Operations

Original data for mail printing can be printed from a PC, and then stuffed into envelope forms using the Wrapping Envelope Finisher.



- See the instruction guide for the application you are using regarding the operation and supported files of the mail creation application.
- This guide only explains the settings for creating mail. For more information on printer driver installation instructions, transmission methods of original data for mail printing, and various printer setting information, see the guides of the ComColor GD Series printer.
- It is also possible to send mail making jobs via an optional print controller. For details, see the user's guide for the print controller (ComColor Express FS2000C).

1 Create original data using any mail creation application.

2 Displaying the printer driver screen.

3 Check [Printer name], and click [Properties] or [Details].

The button names above may vary depending on the application.

4 Place a check mark in [Mail Making].

Place a check mark in [Mail Making] in the [Finishing] tab. When checked, [Details] will be enabled. (p. 1-4 "Mail Making")

5 Make the settings if required.

See "Settings for the Printer Driver" (p. 1-3) for items which can be set with the printer driver.



- Create original data within the printable region. (p. 22 "Printable Area")

6 Click [OK].

The screen returns to the printer dialog box.



- When the [Collated] check box on the print dialog box has been selected, remove the check mark. If you do not remove the check mark, data is sent from the computer to the unit the number of times that copies are specified.
- Depending on the application being used, if there is an item for configuring the "Job / Job Switching" function, select the job to print. If this selection is not made, the enveloping will not be performed.

7 Prepare the printer.

Ready the printer and this unit for use.

For more information, see "Preparations Prior to Creating Mail" (p. 24).

8 Click [Print] or [OK].

Mail creation begins.



- When [Envelope Form Setting Guide] is set to [ON] in the [Admin Menu], a message is displayed before printing a mail making job.
- Before printing the first mail and the final mail in the mail making job, the confirmation message to make a sample mail is displayed.

Settings for the Printer Driver

The following section describes the settings of the printer driver screen when sending mail making jobs.

- The displayed setting items vary depending on the selected items or settings made by the administrator.
- If the optional equipment necessary for the setting is not attached, the setting item is not displayed.

Setting the Printer Configuration

Set the printer configuration when using the printer driver for the first time or adding optional equipment to the printer.

1 Display the [Environment] tab.

The [Environment] tab is displayed by right-clicking on the printer in use from [Devices and Printers] in the [Start] menu and then opening [Printer Properties].

2 Click [Get Printer Info].

Option configuration information can be obtained automatically from the printer. The information acquired from this unit is displayed on [Printer Configuration].

- To configure the printer manually, select [Finisher] - [Wrapping Envelope Finisher].

3 Click [Custom Paper Entry] if required.

You can register up to 99 items worth of irregular size paper.

For more information on the registration method of paper size, see the guides of the ComColor GD Series printer.

- Set manually the same paper size as you set to the application for creating original data.

[Finishing] Tab

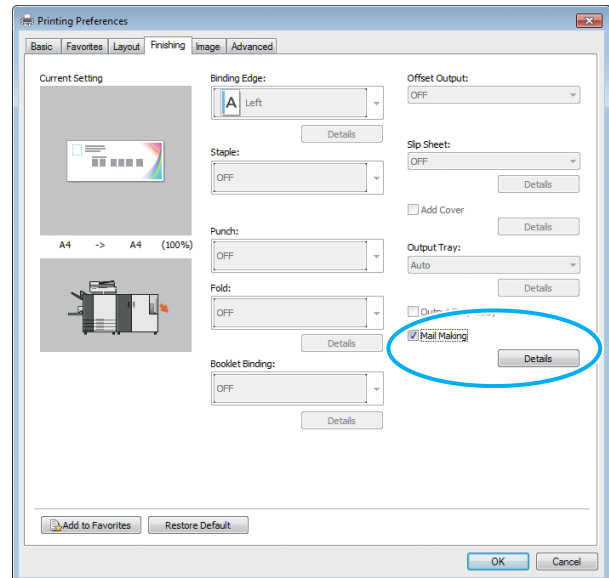

Mail Making

When making mail, place a check mark in [Mail Making].
 Click [Details] to display the [Mail Making] dialog box.
 In the [Mail Making] dialog box, set the envelope form and the enclosures.



- All other items such as menus and buttons in the [Finishing] tab become unavailable.

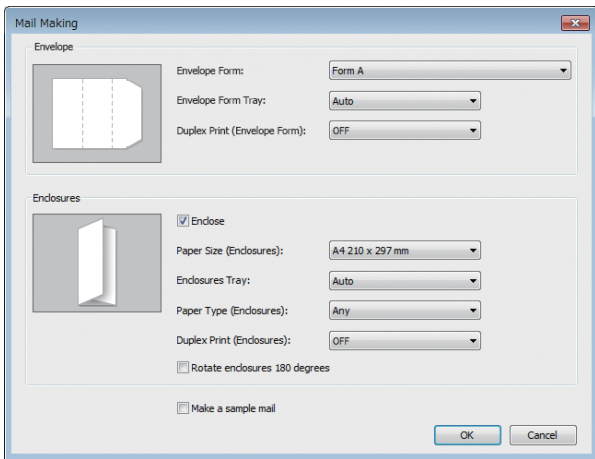

Envelope Form

The size of the envelope form to be printed is displayed.

Envelope Form Tray

Select the tray to set the envelope forms.
 You cannot select the enclosures as the same tray.

[Auto]

The paper tray is automatically selected from the settings of the paper type and envelope form size.

[Feed Tray 1-3]

Select to use the specified feed tray.

[Standard Tray] or the optional [High Capacity Feeder]

Select to use the standard tray.



- When [Auto] has been selected but the paper matching the [Paper Size] setting has not been loaded (or the setting has been completed, but [OFF] is selected in [Auto Selection] of [Paper Selection]), an error occurs and the job is not printed.

Duplex Print (Envelope Form)

[OFF]

Simplex print.

[Long Edge]

Duplex print with the long-edge as the binding side.

[Short Edge]

Duplex print with the short-edge as the binding side.



- You cannot set to simplex/duplex for each mail.
- When using dedicated paper from our company, ensure that you set to [OFF] (do not set to duplex).
- Prepare the original data suitable for the number of sides being printed.

Enclose

Confirm that checks are placed.

Paper Size (Enclosures)

Select the size of the originals to be inserted.
 You cannot insert originals with different sizes when making a mail. Check that the originals are the same size.

Enclosures Tray

Select the tray with the paper to print the enclosures.
 You cannot use the same tray as the envelope forms.

[Auto]

The paper tray is selected automatically from the settings of the paper type and enclosure size.

[Feed Tray 1-3]

Select to use the specified feed tray.

[Standard Tray] or the optional [High Capacity Feeder]

Select to use the standard tray.



- When [Auto] has been selected but the paper matching the [Paper Size (Enclosures)] setting has not been loaded (or the setting has been completed, but [OFF] is selected in [Auto Selection] of [Paper Selection]), an error occurs and the job is not printed.

■ Paper Type (Enclosures)

Select the type of paper.

Before printing, adjust the ink quantity to match the selected paper type and perform image processing.

[Any]

Select the tray depending on the [Paper Size (Enclosures)] settings. Set the paper type of the corresponding tray or the [Default Paper Type of "Any"] setting on the [Environment] tab.

[Plain]

[IJ Paper] / [Matt Coated]

Select one of these when using IJ Paper or similar paper.

[High-Quality]

[Card-IJ]

■ Duplex Print (Enclosures)

Set the print surface.

[OFF]

Simplex print.

[Long Edge]

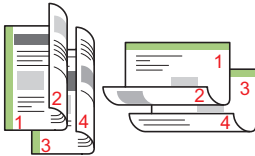

Duplex print with the long-edge as the binding side.

[Short Edge]



Duplex print with the short-edge as the binding side.

■ Rotate enclosures 180 degrees

The paper feed direction of the envelope form is already determined. You can rotate original data and change the orientation of the print to align with the orientation of the enclosures and print.

When rotating the enclosures 180 degrees to print, select the checkbox. The surface that the person views when opening the enclosures is the printed document (first page).

■ Make a sample mail

In order to check the output of the mail, you can make a sample mail of a single copy. Place a check mark when you want to perform a sample mail.

Check the following points when printing a sample mail.

- The glue is adequately adhering.
- The page sequence of the enclosures is the same as indicated in the application.
- The address, stamp position of the sender, and orientation are correct.
- The stamp quality is acceptable (there is no smudging, thin spots, or erased characters).



- Before the first printing run, we recommend that you make a sample mail.
- For a sample mail, the word "SAMPLE" is printed in the center of the envelope form and the enclosures.

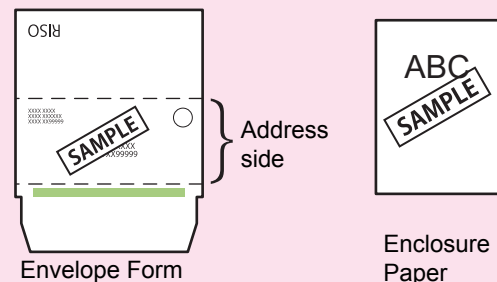

- We recommend that the telecommunications protocol is established to send from an available RAW port that transfers data efficiently when making the sample mail. Check the current printer settings in the [Port] tab in the properties screen of the printer.

About the Orientation of the Enclosures

Regardless of folding method, the orientation of the image when the enclosures are outputted to the Wrapping Envelope Finisher becomes either of the following orientations depending on the settings of [Rotate enclosures 180 degrees].

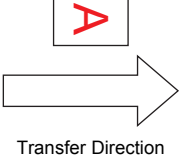
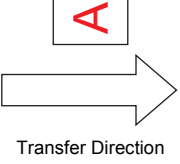
Original Data for Enclosures	Ejected Image Orientation	
	180° Rotation [OFF]	180° Rotation [ON]
		

Operating the Mail Making Jobs

The settings related to the list of jobs to be processed by the printer and the Wrapping Envelope Finisher are operated from the printer. This section describes about jobs with completed mail making settings (mail making jobs).

Changing the Setting During Printing

1 Press the [Stop] key on the printer.

The [Suspending] screen is displayed.

2 Touch [Change settings].

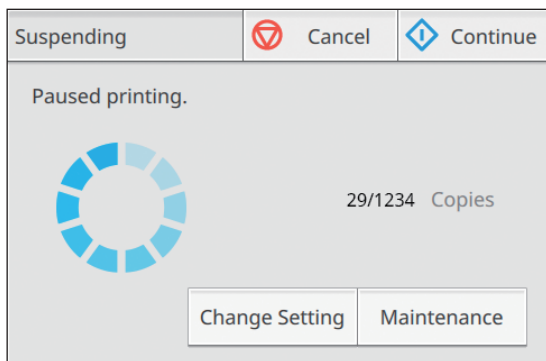

The [Change settings] screen is displayed.

3 Changing the setting.

You can change the following settings.

- Image Position
- Enclosures Tray
You can select the feed tray for the enclosures or set the paper size and type.
- Envelope Form Tray
You can select the feed tray for the envelope form or set the paper size and type.
- Print Density
- Slow Printing

4 Touch [Close].

5 Touch [Continue].

Printing the configured job begins.



- For more information on the setting items and method, see the guides of the ComColor GD Series printer.
- When setting the [Image Position], be careful not to set the glue area of the envelope form over the image. This will cause poor adhesion of the glue.
- The [Enclosures Tray] and the [Envelope Form Tray] cannot be designated as the same tray.
- The [Enclosures Tray] and [Envelope Form Tray] can also be used on the [Change Settings] screen displayed from the [Waiting Job List] screen sub menu.
- When you touch the [Maintenance] on the [Suspending] screen, the [Sample mail making] is displayed on the [Maintenance] screen. For more information, see "Sample Mail Making" (p. 1-9).

Changing the Settings of a Waiting Job

From the list of waiting jobs of the printer, it is possible to change the settings of a mail making job.

- 1 On the [Home 1] screen of the printer, touch [Print].
- 2 Select the job.
- 3 Touch [Change settings] in the sub menu.
You can change the following settings.
 - Image Position
 - Print Density
 - Enclosures Tray
 - Envelope Form Tray
 - Slow Printing
- 4 Touch [OK] and press the [Start] key.

Setting the Mail Making Functions

From the printer, it is possible to configure the limit for the number of enclosures of the Wrapping Envelope Finisher and print samples for checking the mail.

Maximum Pages per Mail

Specify the maximum number of sheets of paper that can be inserted per mail.

- 1 Touch [Maximum Pages per Mail] on the [Maintenance] screen of the printer.

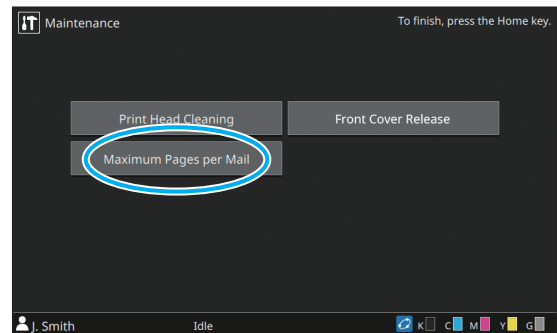

The [Maximum Pages per Mail] screen is displayed.

- 2 Specify the Maximum number of enclosures using the [▲] and [▼] keys, and then touch [OK].

Depending on the type of paper, the number of sheets that can be inserted may differ. (p. 10 "Usable Paper")

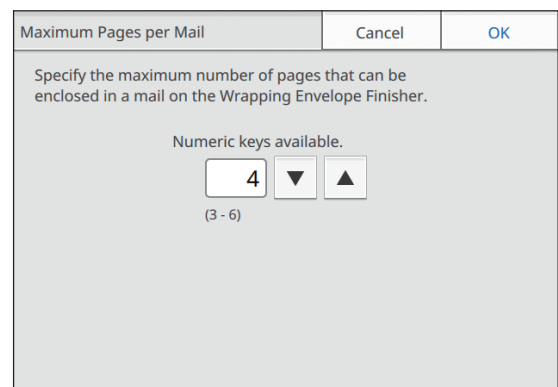

Sample Mail Making

You can check the finishing of the mail by making the first copy as a sample after restarting the print.



- For a sample mail making, the word "SAMPLE" is printed in the center of the envelope form and the enclosures.
- The number of the sample mail is not included in the count of the print copies.

■ When you press the [Stop] key to suspend the printing

1 Touch [Change settings] in the [Suspending] screen.

The [Change settings] screen is displayed.

2 Touch [Sample mail making].

The sample mail making screen is displayed.

- If you touch [Cancel], the sample mail making screen will close.
- If you touch [Continue], the sample print is made.

■ When the printing is suspended because of an error

A confirmation message is displayed when restarting the print after it has been suspended because of an error such as a paper jam.

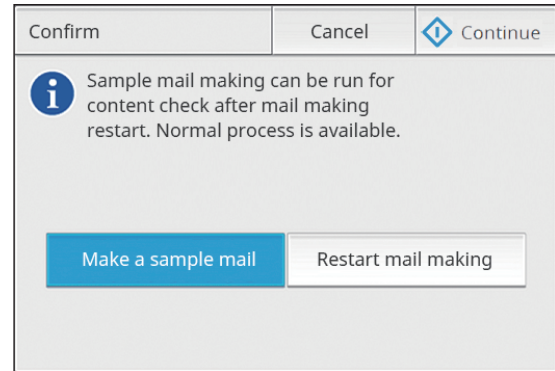

- When you select [Make a sample mail] and touch [Continue], one copy of a sample mail is printed after restart.
- Select [Restart mail making] and touch [Continue] to continue the print.
- The job is cleared if you touch [Cancel] (or the [Stop] key).



- We recommend that you print a sample mail and check the data formation and enclosures for errors.

Admin Menu Settings

In the [Admin Menu], you can change the use environment settings related to the Wrapping Envelope Finisher and the default value. This section describes the settings in related to the Wrapping Envelope Finisher.



- For more information on the administrator mode and methods of the "Admin Menu Settings", see the guides of the ComColor GD Series printer.
- You can set the Admin Menu related to the Wrapping Envelope Finisher from either the operation panel or the RISO Console.

Envelope Form Setting Guide

When starting a mail making job, you can set the application to display a confirmation message regarding the set direction of the envelope form.

■ Settings

[ON] (Factory setting)

[OFF]

1 Touch [Envelope Form Setting Guide] on the [Admin Menu] screen.

2 Select the display method.

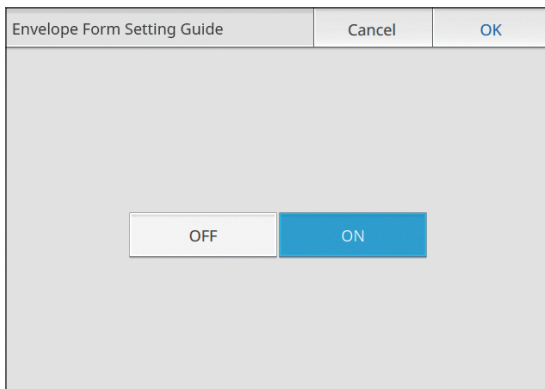

3 Touch [OK].

About the confirmation message

The following message is displayed when starting the mail making job if you set the guide of form setting. Check the orientation of the envelope form in accordance with the message, and set the envelope form.

Example: When setting the envelope forms in the standard tray and making mail with original data that had enclosures (Duplex Settings: OFF).

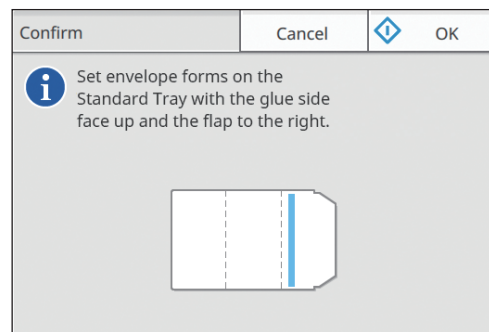

Maintenance

This section describes how to refill the water supply tank, how to interpret errors, and measures to be taken.

Refilling the Water Supply Tankp. 2-2

This section describes how to refill the water supply tank of the Wrapping Envelope Finisher.

Troubleshootingp. 2-4

This section describes how to interpret errors and measures to be taken.



Refilling the Water Supply Tank

This printer uses "Remoistening Glue" and "Pressure-Sensitive Glue" as adhesives of the envelope form. Water is needed for the remoistening glue.

If the amount of water remaining is low, an error message is displayed in the operation panel. Refill the water supply tank in accordance with the message.

WARNING

When supplying or draining water, be careful not to spill water into the interior of the printer. Otherwise, a fire or an electric shock might occur.

- When the water in the water supply tank becomes low, an error is displayed in the operation panel of the printer. Refill the water supply tank with water.
- We recommend that you use purified water, which does not easily deposit limescale.
- Be sure to replace the water in the water supply tank and the water tank once a week. If you use old water, the glue may become difficult to adhere.
- If not using the unit for more than one week, remove the water in the water supply tank and the water tank.

Supplying Water

1 Opening the front cover.

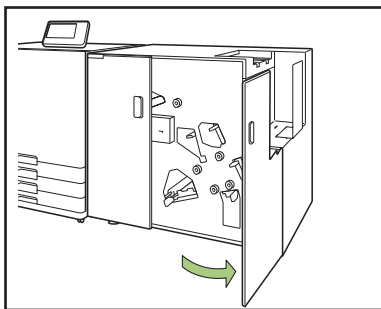

2 Removing the water supply tank.

Lift the water supply tank to remove it. After removing the tank, promptly turn the water supply opening to face upward. This will avoid causing any water leakages from the water supply opening.

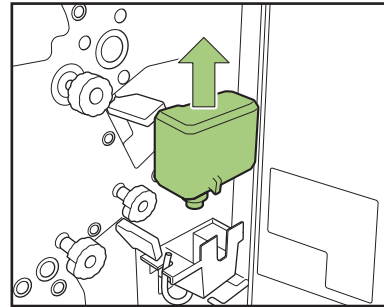

3 Open the cap, and refill the tank with water.

Remove the cap, and supply water.

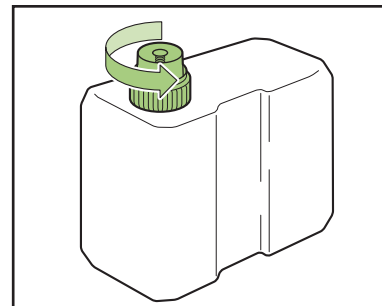

4 Close the cap.

5 Return the water supply tank to its original position.

With the water supply opening facing down, insert the water supply tank.

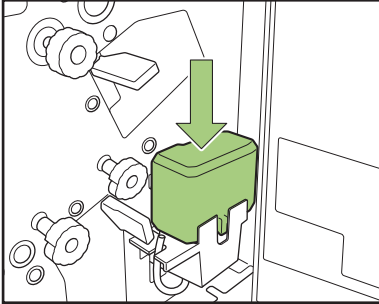

6 Close the front cover.

When supplying water after a "Water is in short supply" message is displayed

When the water supply tank is exhausted or the unit has not been used in a long period of time, the wetting pad may dry out. In this case, it may take a several minutes for the wetting pad to become sufficiently soaked after the water supply tank is refilled. After water supply is completed, make sure that the wetting pad is sufficiently soaked and the envelope form is securely sealed before Mail making. (p. 1-5 "Make a sample mail")

When not using the unit for a long period of time

If not using the unit for more than one week, remove the water in the water tank.

- (1) Open the front cover.
- (2) Prepare a container to receive the water.
- (3) Turn the water drainage tube so that it is facing down, and drain the water inside the water tank until it is empty.
- (4) Return the water drainage tube to its original position.
- (5) Close the front cover.

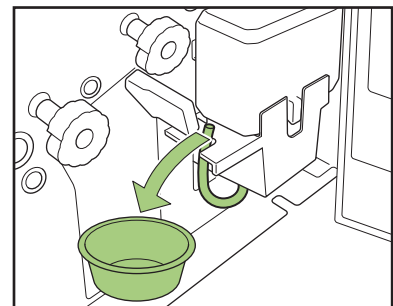

Troubleshooting

This chapter describes the reasons why the error lamp flashes on the operation panel and messages appear on the touch panel, and what action to take.

When the message is displayed, resolve the problem following the instructions in the displayed message.

Error lamp of the printer's operation panel

When an error occurs, the error lamp flashes in red.

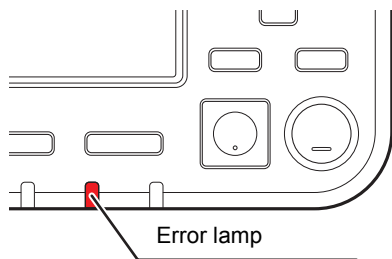

Error message screen on the printer's touch panel

A description of the problem and instructions for resolving the problem are displayed, as shown in the illustration below.



- An alphanumeric error code is displayed at the top of the error message screen. Be sure to mention this error code when contacting your service representative.
 - The first letter of the error code indicates the type of problem.
 - The numbers vary depending on the location of the problem.

Examples of the messages

The following are examples of messages. Follow the instructions in the displayed messages to resolve the problems.



- [Cancel] and [Continue] may be displayed on some message screens. Touch [Cancel] to stop the current operation. Touch [Continue] to resume the current operation.

<S000-0000> Service Call

These error messages are displayed when inspection or repair is required by a service representative.

Message	Action to Take
The Wrapping Envelope Finisher has an error. Press the power key on the operation panel to turn off the power and then on again. If recovery has failed, call service.	An error has occurred with the Wrapping Envelope Finisher. (1) Press the [Power] key on the operation panel to turn off the power and then on again. (2) If the system does not recover, contact your dealer or authorized service representative. Mention the error code displayed on the touch panel at that time.

2

<U000-0000> Unit Error

These error messages are displayed when repair is required by a service representative.

Message	Action to Take
The Wrapping Envelope Finisher has an error. Press the Reset key or reboot by pressing the power key on the operation panel. If recovery has failed, call service.	An error has occurred with the Wrapping Envelope Finisher. (1) Press the [Reset] key on the operation panel. (2) If the system does not recover, press the [Power] key to turn off the power and then on again.
The Paper guide has an error. Press Reset key or Reboot by pressing the power key on the operation panel. If recovery has failed, call service.	If either of the two recovery operations above does not help solve your error, contact your dealer or authorized service representative. Mention the error code displayed on the touch panel at that time.

<X000-0000> Paper Jam

These error messages are displayed when there is a paper jam.

Message	Action to Take
Buttons indicate paper jam locations. To display how to fix, touch the button.	Paper is jammed inside the printer or Wrapping Envelope Finisher, or no paper or multiple sheets of paper fed. Touch the button indicating the location of the paper jam to display how to remove the jammed paper, and follow the procedure displayed on the touch panel to remove the paper. For more information, see "Paper jam" (p. 2-9).
Several sheets of paper may have been fed overlapped. Check the printouts.	The paper has been double fed into the Wrapping Envelope Finisher. Remove the paper, and check the finishing in the [Make a sample mail] of the confirmation screen. If there has been an enclosure error, clear the job and resend original data.

Chapter 2 Maintenance

<Y000-0000> Consumable Error

These error messages are displayed when it is time to replace consumables or parts that require periodical replacement.

Message	Action to Take
Water is in short supply. Refill the Water Supply Tank with water.	The water in the water supply tank is in short supply. Refill the water supply tank with water. For more information, see "Refilling the Water Supply Tank" (p. 2-2).

<Z000-0000> Check Settings Error

These error messages are displayed when the cover is not completely closed.

Message	Action to Take
Close the cover of the Wrapping Envelope Finisher.	The front cover is not completely closed. Securely close it.

<W000-0000> Warning

These warning messages are displayed when there is no more paper, the mail stacker is full, a peripheral device is not connected, or there is another problem.

Message	Action to Take
Job name: This printing job is not acceptable because Wrapping Envelope Finisher is unavailable. Printing without using Wrapping Envelope Finisher is possible. (The job has been deleted).	Turn off the power of the Wrapping Envelope Finisher and then on again. For more information on turning the power on, see "Power" (p. 24). If the recovery operations above does not help solve your error, contact your dealer or authorized service representative. Touch [Close] to continue using the printing functions other than for mail making.
Job name: Printing is not possible because this job has inexecutable original. Please check the original. (The job has been deleted).	Data formulation of the first mail was not correct. For more information on data formulation, see "Original Data Structure of "Mails"" (p. 19). (1) Touch [Close]. (2) The continue confirmation screen is displayed. Touch [Close]. (3) Correct or clear the part of original data that is incorrect and resend it.
The mail stacker is full. Remove the mails.	(1) The mails stacked in the mail stacker is exceeding the maximum number of mails. Remove the mails. (2) If the print is not finished, press the [Start] key to continue the printing.
Mail No. This job cannot be done due to the maximum number of enclosures exceeded. Check the data. (The job has been deleted).	The mail is exceeding the maximum number of enclosures. Touch [Close]. For more information on the number of enclosures, see "Maximum Pages per Mail" (p. 1-8). In [Details] of the [Mail Making], if a check mark is not placed in [Enclose], you cannot print if the enclosure data is contained. Correct or clear the incorrect part of original data, and resend the data.

Message	Action to Take
<p>Mail No. Data with a size different from the specified enclosure size has been found. Check the settings. (The job has been deleted).</p>	<p>Different size data is mixed among a job. Touch [Close]. Correct or clear the incorrect part of original data, and resend the data.</p>
<p>Mail No. The data for enclosures are missing. Check the data. (The job has been deleted).</p>	<p>In [Details] of the mail making print, a check mark is placed in [Enclose], however, the original data for the enclosures does not exist. Otherwise, the combination of data for the envelope forms and enclosures is incorrect. (1) Touch [Close]. (2) The continue confirmation screen is displayed. Touch [Close]. (3) Correct or clear the incorrect part of original data and resend the data.</p>
<p>Mail No. Envelope form data with a size different from the specified size was found. Check the settings. (The job has been deleted).</p>	<p>The data contains the enclosure data whose size is different from the envelope form specified in [Details] of Mail making. Otherwise, original data for the envelope forms does not exist. Make the envelope forms for one job all the same size. (1) Touch [Close]. (2) The continue confirmation screen is displayed. Touch [Close]. (3) Correct or clear the part of original data that is incorrect and resend it.</p>
<p>Some data have different envelope form sizes. Check the settings. (The job has been deleted).</p>	<p>Envelope forms with different sizes exist among one job. Touch [Close]. Correct or clear the incorrect part of original data, and resend the data.</p>
<p>Load paper for enclosures in the following tray. Tray:</p>	<p>The tray for the designated enclosures is empty. Otherwise, different size paper has been loaded. Load cover paper of the same size as that of the body pages.</p>
<p>Set the envelope form in the direction below. Standard Tray: Glue side up(down), flap right(left) Feed Tray 1-3: Glue side down(up), flap left(right)</p>	<ul style="list-style-type: none"> Though the tray for envelope forms is set to [Auto], there are no envelope form in the tray subject to automatic selection. Touch [Change Tray] to change the feed tray to other than [Auto] or set the tray for envelope forms in [Auto Selection]. When you [Continue] the print, check the orientation of the envelope forms and set them in the standard tray or feed tray.
<p>Set the envelope form in the Standard Tray with the glue side face up(down) and the flap to the right(left).</p>	<ul style="list-style-type: none"> The tray for the designated envelope forms is empty. Check the orientation of the envelope forms, and set them in the standard tray or the feed tray.
<p>Set the envelope form in Feed Tray 1 (Tray 2, Tray 3) with the glue side face down(up) and the flap to the left(right).</p>	<p>Alternatively touch [Change Tray] to change the tray for envelope forms.</p>

Message	Action to Take
Set the paper guide (end).	The paper guide (end) has not been set. Set the paper guide (end).
Check the position of the paper guide (end).	The paper guide (end) position is incorrect. Correct the position of the paper guide (end).
Data reception is slow. Wait. If the data is not output, delete the job.	The data is being received. If data has not been received after a certain period of time, clear the job for which data is being received, and resend the data.
The Wrapping Envelope Finisher does not support long-edge feed. Check the settings. (The job has been deleted).	The Wrapping Envelope Finisher supports only short-edge feed. Check whether or not the image rotation or the set direction of the paper is correct.
Mails are left in the stacking tray. Print cannot be run. Remove the mails from the stacking tray.	Something may be placed in the mail stacker area. Check and remove anything that might be located around the belt periphery of the mail stacker.
Appropriate temperature is not maintained inside the Wrapping Envelope Finisher. (The job has been deleted).	The temperature inside the Wrapping Envelope Finisher may be low. Use the Wrapping Envelope Finisher after confirming that the environment is appropriate. "Installation Location" (p. 8)

Paper jam

If a paper jam occurs in the Wrapping Envelope Finisher, the error lamp on the operation panel flashes in red, and the paper jam location is displayed on the touch panel. Follow the procedure displayed on the touch panel to remove the jammed paper and resume printing.

CAUTION

Be careful of protruding parts and metal terminals when inserting your hand in the machine, such as when removing jammed paper. Otherwise, an injury might occur.

1 Touch the alphanumeric button indicating the location of the paper jam to display how to remove the jammed paper.

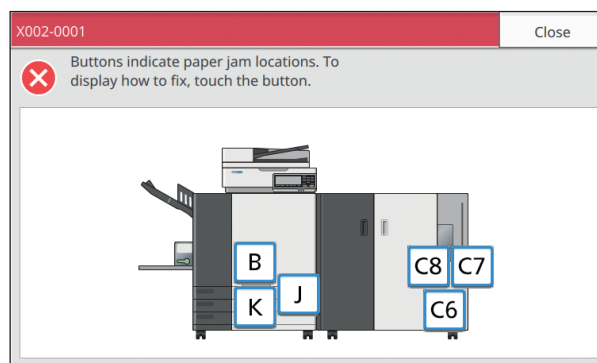

2 Follow the procedure displayed on the touch panel to remove the paper.

Touch [Back] or [Next] to display the previous or next page.
(The screenshots below are examples of the display when there is a paper jam.)

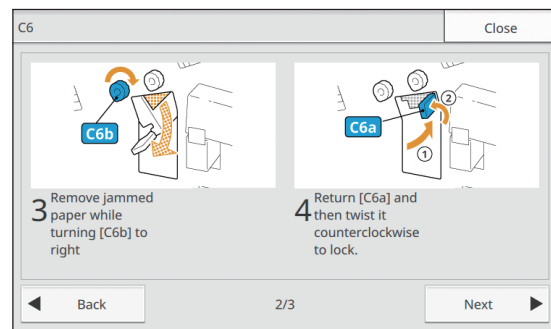
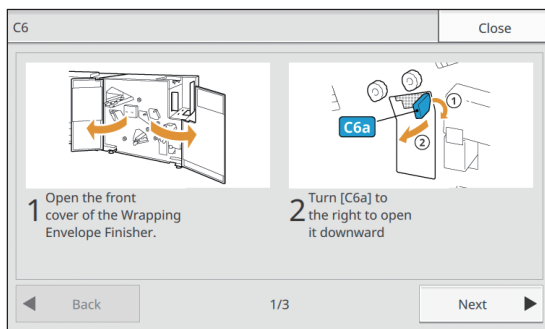

3 Touch [Close].

The display will return to the screen of Step 1. Check that the button indicating the location where the paper was removed has disappeared.

When all of the jammed paper is removed and the cover is closed, the error screen closes and the previous screen is displayed.

-  As long as alphabet buttons are displayed on the screen, paper still remains in the indicated locations. Repeat Steps 1 to 3 to remove the jammed paper.

Precautions When Removing Jammed Paper

- Slowly and carefully remove the jammed paper. Be careful not to leave pieces of paper in the Wrapping Envelope Finisher.
- When removing the paper from the unit, roll the paper a little at a time in the output direction inside the unit, and then remove the paper toward you.

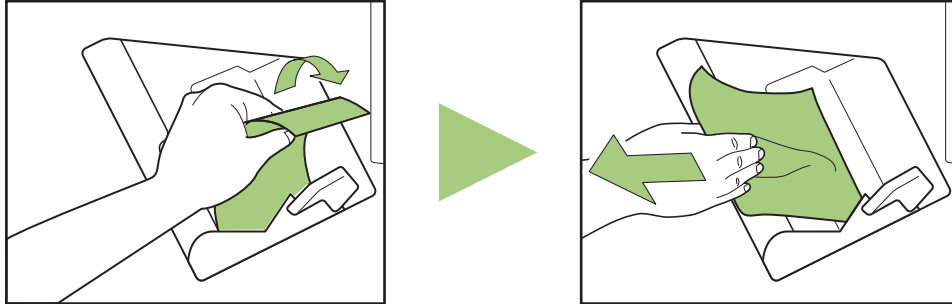

- Paper is transferred through the printer at a high speed during printing. Therefore, if a paper jam occurs when printing multiple sheets of paper, the sheet of paper that caused the paper jam as well as other sheets of paper may remain in the transfer path. When using an internal dial to remove jammed paper, turn the dial four or five times after removing the first sheet of paper, to check for other sheets of paper.

Other problems

The Wrapping Envelope Finisher does not operate at all.

- Make sure that the main power of the printer and Wrapping Envelope Finisher has been turned on.
- Make sure that the power plug of the printer and Wrapping Envelope Finisher has been properly inserted into the electrical outlet.
- Make sure that the power cords have been securely connected to the printer and Wrapping Envelope Finisher.
- Make sure that the power breaker has not been tripped.
- Turn off the power of the printer and Wrapping Envelope Finisher and then turn on again. For more information, see "Power" (p. 24). If the Wrapping Envelope Finisher does not recover, contact your dealer or authorized service representative.

The setting buttons of the Wrapping Envelope Finisher is not displayed on the printer's touch panel.

- Make sure that the main power of the Wrapping Envelope Finisher has been turned on.

Glue is not adequately applied to the envelope.

- There is not enough water applied to the wetting pad. Refill the water supply tank.
- Do not touch the envelope form immediately after it is sealed. This may impact the setting of the glue and make cause the seal to peel.
- Make sure that the set direction of the envelope forms is correct.

Adhesion of the glue is not possible (weak).

- If rubber, dust, or ink is attached to the surface area of the remoistening glue or pressure-sensitive glue, then there will be no adhesion.
- If you store the envelope form while exposing them to air, or store them in a location that is subject to direct sunlight, the glue strength may deteriorate due to the affect from temperature, humidity, ultraviolet rays, oxygen, ozone, and other factors. Use all the envelope form of the shrink packaging, or be sure to store them with the front side up in the storage case and use all of them within a month.
- If the expiry date is exceeded, the strength of the adhesion will deteriorate. Check the date of manufacture and use the glue as soon as possible.

The image of the output is different.

- Make sure that the set direction of the envelope forms and enclosures is correct.
- Make sure whether or not a setting has been made to rotate the paper 180 degrees.

The transfer speed is slow.

- The "Remoistening Glue" area of the envelope forms has become wet because the wetting pad and is sealing the envelope forms. If the temperature inside the printer is low, the adhesion quality of the "Remoistening Glue" may deteriorate. When you start the print, the print speed may become slower to ensure that the temperature inside the printer is adequate, that there is enough time applied for pressure-sensitive glue, and that the glue is properly adhering. When the inside of the printer has reached the set temperature and you have switched jobs, the printer will return to the normal printing speed.



- For more information on the troubles related to the print condition or printer, see the guides of the ComColor GD Series printer.



The message of "The transfer belt is dirty" frequently appears.

- Check the printer driver setting.
Depending on the type of graphic images to be printed, strike-through may be generated, and the transfer belt stained with ink when [High Chromogenic] is specified in [Image Quality]. Do not specify [High Chromogenic] for the duplex printing or printing with many solid images.

This section includes the specifications, a list of consumable items, a glossary, and describes after-sales service.

Specifications p. 3-2

This section describes the basic specifications of the Wrapping Envelope Finisher.

Consumables p. 3-6

This section describes the types of consumable items.

Index p. 3-7

Vorsichtsmaßnahmen p. 3-10

Vor Inbetriebnahme p. 3-13

Technische Daten p. 3-20

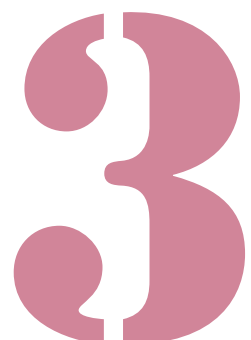

Specifications

■ Specifications of the Wrapping Envelope Finisher G10 (E)

Basic Functions and Mail Making Functions

Model		Wrapping Envelope Finisher G10 (E)	
Type		In-Line Sealed Mail Making System	
Finishing Type		Sealed Mail Making	
Dedicated Paper for Envelopes		Wrapping Envelope Form A: 233 mm × 296 mm Approx. 105 g/m ²	Wrapping Envelope Form B: 233 mm × 391 mm Approx. 105 g/m ²
Enclosure Paper	Paper Size	A4 (210 × 297 mm), JIS-B5 (182 × 257 mm)	
	Paper Type and Weight	Standard Tray	Plain paper, recycled paper 46 g/m ² - 120 g/m ² paper
Feed Tray		Plain paper, recycled paper 52 g/m ² - 104 g/m ² paper	
Printable Area		Dedicated Paper for Envelopes ¹	Maximum: 212 mm × 217 mm
		Guaranteed Print Area for Enclosures	Standard: Margin width of 3 mm
			Maximum: Margin width of 1 mm
Paper Tray Capacity	Standard Tray	Dedicated Paper for Envelopes ¹ : Height up to 110 mm Dedicated Paper for Enclosures: Height up to 110 mm	
	Feed Tray	Dedicated Paper for Envelopes ¹ : Height up to 50 mm (3 trays) Dedicated Paper for Enclosures: Height up to 50 mm (3 trays)	
	High capacity feeder (Optional)	Dedicated Paper for Envelopes ¹ : Height up to 440 mm Dedicated Paper for Enclosures: Height up to 440 mm	
Maximum Load of the Mail Stacker		Height up to 310 mm (Approx. 110 mails: IJ paper (85 g/m ²)/1 sheet enclosure with Inner 3-folds)	
Number of Enclosure Sheets		46 g/m ² - 59 g/m ²	6 sheets or less
		60 g/m ² - 80 g/m ²	5 sheets or less
		81 g/m ² - 100 g/m ²	4 sheets or less
		101 g/m ² - 120 g/m ²	3 sheets or less
Adhesion Method		Mail short-edge part	Pressurized adhesion method to the pressure-sensitive adhesive coated area.
		Mail long-edge part	Wet coating adhesion method to the remoistening adhesive coated area.
Remoistening Adhesive		Supplementation Method	Replenish from the water supply tank (removal possible)
		Water Supply Tank Capacity	400 ml
		Water Tank Capacity Inside Printer	480 ml
Finished Product Mail Size		Wrapping Envelope Form A: 233 mm × 110 mm Wrapping Envelope Form B: 233 mm × 158 mm	
Processing Speed ²		40 mails/min for A4 simplex	
Power Source		AC100-240 V, 3.0-1.5 A, 50-60 Hz	
Power Consumption		Max. 250 W Ready: 40 W or less Stand-by: 0.5 W or less	

Operating Noise ³	68 dB (A) or less
Operating Environment	Temperature: 15 °C - 30 °C Humidity: 40% - 70% RH (non-condensing)
Weight ⁴	Approx. 161 kg
Safety Information	IEC60950-1 compliant, Indoor, pollution degree 2*, At altitudes of 2000 m or lower * The pollution degree of the usage environment due to dirt and dust in the air. Degree "2" corresponds to a general indoor environment.
Dimensions (W × D × H) ⁴	Wrapping Envelope Finisher: 990 mm × 710 mm × 960 mm
	When connected to the printer (in a state where the operation panel is upright at 90°): 2,270 mm ⁵ × 1,280 mm × 1,160 mm

- 1 When using Wrapping Envelope Form A (approx. 105 g/m²)
- 2 When using ComColor GD9630: When inserting one sheet for A4 simplex printing
- 3 When connected to a printer and sealing the envelope form with one enclosure sheet
- 4 Excluding the storage case
- 5 When the paper guide (end) is attached at an angle (excluding the space to collect the ejected mails)

■ Specifications of the Wrapping Envelope Finisher G10 (U)

Basic Functions and Mail Making Functions

Model		Wrapping Envelope Finisher G10 (U)	
Type		In-Line Sealed Mail Making System	
Finishing Type		Sealed Mail Making	
Dedicated Paper for Envelopes		Wrapping Envelope Form C: 243 mm × 296 mm (9 9/16" × 11 21/32") Approx. 105 g/m ² (28-lb bond)	
Enclosure Paper	Paper Size	Legal (8 1/2" × 14"), Letter (8 1/2" × 11")	
	Paper Type and Weight	Standard Tray	Plain paper, recycled paper 46 g/m ² - 120 g/m ² (12.2-lb bond - 31.9-lb bond) paper
Feed Tray		Plain paper, recycled paper 52 g/m ² - 104 g/m ² (14-lb bond - 28-lb bond) paper	
Printable Area		Dedicated Paper for Envelopes	Wrapping Envelope Form C made by RISO Maximum: 222 mm × 217 mm (8 23/32" × 8 9/16")
		Guaranteed Print Area for Enclosures	Standard: Margin width of 3 mm (1/8")
			Maximum: Margin width of 1 mm (3/64")
Paper Tray Capacity	Standard Tray	Dedicated Paper for Envelopes ¹ : Height up to 110 mm (4 5/16") Dedicated Paper for Enclosures: Height up to 110 mm (4 5/16")	
	Feed Tray	Dedicated Paper for Envelopes ¹ : Height up to 50 mm (1 31/32") (3 trays) Dedicated Paper for Enclosures: Height up to 50 mm (1 31/32") (3 trays)	
	High capacity feeder (Optional)	Dedicated Paper for Envelopes ¹ : Height up to 440 mm (17 11/32") Dedicated Paper for Enclosures: Height up to 440 mm (17 11/32")	
Maximum Load of the Mail Stacker		Height up to 310 mm (12 7/32") (Approx. 110 mails: IJ paper (85 g/m ² (23-lb bond))/1 sheet enclosure with Inner 3-folds)	
Number of Enclosure Sheets	(When the size is Letter)	46 g/m ² - 59 g/m ² (12.2-lb bond - 15.7-lb bond)	6 sheets or less
		60 g/m ² - 80 g/m ² (16-lb bond - 21.3-lb bond)	5 sheets or less
		81 g/m ² - 100 g/m ² (21.5-lb bond - 26.6-lb bond)	4 sheets or less
		101 g/m ² - 120 g/m ² (26.9-lb bond - 31.9-lb bond)	3 sheets or less
	(When the size is Legal)	46 g/m ² - 59 g/m ² (12.2-lb bond - 15.7-lb bond)	4 sheets or less
		60 g/m ² - 80 g/m ² (16-lb bond - 21.3-lb bond)	3 sheets or less
		81 g/m ² - 100 g/m ² (21.5-lb bond - 26.6-lb bond)	2 sheets or less
		101 g/m ² - 120 g/m ² (26.9-lb bond - 31.9-lb bond)	1 sheet
Adhesion Method		Mail short-edge part	Pressurized adhesion method to the pressure-sensitive adhesive coated area.
		Mail long-edge part	Wet coating adhesion method to the remoistening adhesive coated area.

Remoistening Adhesive	Supplementation Method	Replenish from the water supply tank (removal possible)
	Water Supply Tank Capacity	400 ml
	Water Tank Capacity Inside Printer	480 ml
Finished Product Mail Size	243 mm × 110 mm (9 9/16" × 4 5/16")	
Processing Speed ²	41 mails / min for Letter simplex.	
Power Source	AC100-240 V, 3.0-1.5 A, 50-60 Hz	
Power Consumption	Max. 250 W Ready: 40 W or less Stand-by: 0.5 W or less	
Operating Noise ³	68 dB (A) or less	
Operating Environment	Temperature: 15 °C - 30 °C (59 °F - 86 °F) Humidity: 40% - 70% RH (non-condensing)	
Weight ⁴	Approx. 161 kg (355-lb)	
Safety Information	IEC60950-1 compliant, Indoor, pollution degree 2*, At altitudes of 2000 m or lower * The pollution degree of the usage environment due to dirt and dust in the air. Degree "2" corresponds to a general indoor environment.	
Dimensions (W × D × H) ⁴	Wrapping Envelope Finisher: 990 mm × 710 mm × 960 mm (38 31/32" × 27 15/16" × 37 13/16")	
	When connected to the printer (in a state where the operation panel is upright at 90°): 2,270 mm ⁵ × 1,280 mm × 1,160 mm (89 3/8" × 50 3/8" × 45 21/32")	

- 1 When using Wrapping Envelope Form C (approx. 105 g/m² (28-lb bond))
- 2 For ComColor GD9630: When inserting one sheet for Letter simplex printing
- 3 When connecting the printer and sealing the envelope form with one enclosure sheet
- 4 Excluding the storage case
- 5 When the paper guide (end) is attached at an angle (excluding the space to collect the ejected mails)

Consumables

It is recommended that you use consumables manufactured by RISO KAGAKU CORPORATION.

Consumable specifications and types are subject to change without notice.

For pricing information, contact your dealer or authorized service representative.

Consumable Items

Item	Size	Contents	Characteristics
Wrapping Envelope Form A	233 mm × 296 mm	250 sheets × 4 packs	You can seal A4 or B5 enclosures by 3-fold.
Wrapping Envelope Form B	233 mm × 391 mm		You can seal A4 enclosures by 2-fold.
Wrapping Envelope Form C	243 mm × 296 mm (9 9/16" × 11 21/32")		You can seal Letter enclosures by Inner 3-fold or Legal by 4-fold.

Index

Numerics

1 Job	18
★ Mark	17
● Mark	17

A

Admin menu	1-2, 1-10
Admin menu settings	1-10
Any	1-5

B

Bottom plate	15, 29
--------------------	--------

C

Card-IJ	1-5
Changing the setting	1-7
Continue	1-9

D

Duplex print (enclosures)	1-5
Duplex print (envelope form)	1-4

E

Enclose	1-4
Enclosures	18, 2-6
Enclosures tray	1-4
Envelope form	17, 18, 25, 1-4
Envelope form setting guide	1-2, 1-10
Envelope form tray	1-4
Envelope stuffing method	17
Environment tab	1-3
Error lamp	2-4

F

Face down finisher	10
Face down tray	15
Feed tray	25
Finisher	1-3
Finishing tab	1-2, 1-3
Free output	29
Front cover	15, 2-2

G

Guide of form setting	1-10
-----------------------------	------

H

High capacity feeder	10, 25, 1-4
High-quality	1-5

I

IJ paper	1-5
----------------	-----

L

Long edge	1-4, 1-5
-----------------	----------

M

Mail creation application	1-2
Mail making	1-2, 1-4
Mail making job	1-7
Mail stacker	15
Mails	16, 18
Main power switch	15
Make a sample mail	1-5
Matt coated	1-5
Maximum pages per mail	1-8

O

Original data structure	19
-------------------------------	----

P

Paper feed guide levers	27
Paper feed pressure adjustment lever	28
Paper guide (end)	15, 28
Paper guide (side)	15, 28
Paper size (enclosures)	1-4
Paper type (enclosures)	1-5
Pressure-sensitive glue	17, 2-2, 2-11
Printable area	22
Printer driver screen	1-2, 1-3

R

Remoistening glue	17
RISO console	24, 29, 1-10
Rotate enclosures 180 degrees	1-5

S

Sample mail making 1-7, 1-9
Scanner 10
Secret pattern 17
Short edge 1-4, 1-5
Silicon coating 17
Stacking output 28
Standard tray 25, 27
Stop key 1-7, 1-9
Stopper 25, 26

T

Tray for the designated enclosures 2-7
Tray for the designated envelope forms 2-7

W

Water is in short supply 2-3
Water supply tank 15, 30, 2-2
Wetting pads 30, 2-3, 2-11
Wrapping envelope finisher 3-2, 3-4
Wrapping envelope form 11, 3-2, 3-4

Notice for European Union Member States

RISO, the environment and the Waste Electrical and Electronic Equipment Directive "WEEE Directive"

What is the WEEE Directive?

The purpose of the WEEE Directive is to reduce waste and ensure Electrical and Electronic Equipment is recycled at the end of its useful life.



What does the crossed out wheeled bin symbol mean?

The crossed out wheeled bin symbol indicates this product must be disposed of separately to normal waste. Please contact your RISO service agent for information about disposal.

What does the solid bar symbol mean?

The solid bar under the crossed out wheeled bin indicates this product was put on the market after the 13th August 2005.

Who should I contact if I want more information about the WEEE Directive?

You should contact your local RISO service agent for more information.

Vorsichtsmaßnahmen

ComColor GD Serie

Modell: Wrapping Envelope Finisher G10 (E)

MASCHINENLÄRMINFORMATION

Maschinenlärminformations-Verordnung 3. GPSGV:

Der höchste Schalldruckpegel beträgt 70 dB(A) oder weniger gemäß EN ISO 7779.



Hinweis: Das Gerät ist nicht für die Benutzung am Bildschirmarbeitsplatz gemäss BildscharbV vorgesehen.

Copyright © 2016 RISO KAGAKU CORPORATION





Dieser Abschnitt beschreibt Vorkehrungen, die zur sicheren Benutzung dieser Maschine befolgt werden müssen. Bitte lesen Sie diesen Abschnitt vor der Benutzung gut durch.

Warnsymbole

Damit diese Maschine richtig betrieben wird und Verletzungen sowie Sachschäden vermieden werden, kommen folgende Warnsymbole zur Anwendung. Lesen Sie zuerst die Bedeutung der Symbole durch und danach das Handbuch.

 WARNUNG	Dieses Symbol bedeutet, dass eine unrichtige Handhabung beziehungsweise das Ignorieren dieses Symbols zum Tod oder schweren Verletzungen führen kann.
 VORSICHT	Dieses Symbol bedeutet, dass eine unrichtige Handhabung beziehungsweise das Ignorieren dieses Symbols zu schweren Verletzungen oder Sachschäden führen kann.

Symbolbeispiele

	Das Symbol  zeigt eine verbotene Aktion an. Ein konkretes, verbotenes Vorgehen wird im Symbol selbst oder daneben angegeben. (Die linke Abbildung zeigt das Verbot des Auseinandernehmens.)
	Das Symbol  zeigt eine zwingende Aktion oder einen Hinweis an. Im Symbol wird ein konkreter Hinweis angegeben. (Die linke Abbildung zeigt einen Hinweis zum Herausziehen des Netzsteckers.)

Netzstecker

- Zusätzlich zum Hauptgerät haben auch Drucker und Zusatzgeräte, die mit dem Drucker verbunden sind, Netzstecker.



Aufstellungsort

VORSICHT

- Stellen Sie diese Maschine auf einer ebenen oder stabilen Oberfläche auf. Andernfalls könnte sich die Maschine neigen und hinunterfallen und dadurch Verletzungen verursachen.
- Stellen Sie die Maschine nicht an einem staubigen oder feuchten Ort auf. Andernfalls kann es zum Brand oder zu elektrischen Schlägen kommen.

Netzanschluss

WARNUNG

- Verwenden Sie dieses Gerät mit der Nennspannung. Verwenden Sie eine Stromquelle mit ausreichender Toleranz. Andernfalls kann es zum Brand oder zu elektrischen Schlägen kommen.
- Installieren Sie die Maschine in der Nähe einer Netzsteckdose, um die Verwendung eines Verlängerungskabels zwischen Maschine und Steckdose zu vermeiden. Falls trotzdem ein Verlängerungskabel benötigt wird, darf es nicht länger als 5 m sein. Andernfalls kann es zum Brand oder zu elektrischen Schlägen kommen. 
- Das Spannungskabel darf weder beschädigt noch abgeändert werden. Werden schwere Gegenstände auf das Kabel gestellt, oder wird daran gezogen oder das Kabel geknickt, kann das Kabel Schaden erleiden, und dadurch einen Brand bzw. einen elektrischen Schlag verursachen. 

- Das mitgelieferte Spannungskabel darf nur für diese Maschine verwendet werden. Verwenden Sie es nicht mit anderen Produkten. Andernfalls kann es zum Brand oder zu elektrischen Schlägen kommen.
- Niemals das Kabel mit nassen Händen aus der Steckdose ziehen. Andernfalls könnte es einen elektrischen Schlag geben.

VORSICHT

- Schließen Sie das Stromkabel fest in den optionalen Netzanschluss der Druckereinheit, um einen Wackelkontakt zu vermeiden.
- Ziehen Sie den Stecker nicht am Kabel heraus. Andernfalls kann dieses beschädigt werden und einen Brand oder einen elektrischen Schlag verursachen. Zum Abtrennen des Kabels immer nur am Stecker anfassen.
- Falls die Maschine für längere Zeit nicht gebraucht wird, beispielsweise über mehrere Feier- oder Ferientage hinweg, sollte das Netzkabel sicherheitshalber aus der Steckdose gezogen werden.
- Ziehen Sie den Stecker mehr als einmal pro Jahr aus der Steckdose und reinigen Sie seine Polstifte und ihre Umgebung. Staub, der sich an dieser Stelle angesammelt hat, könnte einen Brand verursachen.

Behandlung

WARNUNG

- Stellen Sie keine Wassergefäße oder Metallobjekte auf die Maschine. Falls Wasser oder ein solches Metallobjekt ins Innere des Gerätes eindringt, kann dies zu einem Brand oder zu elektrischen Schlägen führen.
- Entfernen Sie die Abdeckungen nicht. Andernfalls könnten Sie aufgrund der Hochspannung im Inneren elektrischen Schlägen ausgesetzt sein. 
- Sie sollten die Maschine nie zerlegen oder selbst zusammenbauen. Andernfalls kann es zum Brand oder zu elektrischen Schlägen kommen.
- Lassen Sie keinerlei metallische Gegenstände oder entzündbares Material durch irgendeine Öffnung ins Innere der Maschine eindringen. Andernfalls kann es zum Brand oder zu elektrischen Schlägen kommen.
- Achten Sie beim Einfüllen oder Ablassen von Wasser darauf, dass kein Wasser ins Innere des Druckers gelangt. Andernfalls kann es zum Brand oder zu elektrischen Schlägen kommen.
- Wenn etwas in das Gerät hineinfällt, halten Sie sofort die [Netz]-Taste am Bedienfeld gedrückt und schalten Sie die Stromversorgung und dann den Hauptstromschalter aus. Trennen Sie dann alle Stromkabel und wenden Sie sich an Ihren Händler oder den Kundendienst. Das Weiterbenutzen des Gerätes könnte einen Brand oder einen Stromschlag verursachen. 
- Im unwahrscheinlichen Fall, dass das Gerät weiter benutzt wird, während es übermäßige Hitze, Rauch oder einen schlechten Geruch verströmt, kann es zu einem Stromschlag kommen. Halten Sie sofort die [Netz]-Taste am Bedienfeld gedrückt und schalten Sie die Stromversorgung und dann den Hauptstromschalter aus. Trennen Sie dann unbedingt alle Stromkabel und wenden Sie sich an Ihren Händler oder den Kundendienst. 

VORSICHT

- Stecken Sie nicht Ihre Finger oder irgendwelche Gegenstände in den Spalt der Mail-Ablage. Andernfalls kann es zu Verletzungen kommen.
- Wenn Sie das Innere des Druckers überprüfen und z.B. eingeklemmtes Papier entfernen, achten Sie bitte auf hervorstehende Teile oder Metallenden. Andernfalls kann es zu Verletzungen kommen.
- Im Inneren des Druckers können sich Restbestände von Tinte befinden. Achten Sie darauf, mit Ihren Händen oder Kleidungsstücken nicht damit in Kontakt zu kommen. Sollten Sie versehentlich mit Ihren Händen dennoch die Tinte berühren, waschen Sie Ihre Hände sofort mit einem Reinigungsmittel.
- Wenn Sie die Maschine an einen anderen Ort verlegen, benachrichtigen Sie zuvor die Servicestelle. Falls Sie versuchen, die Maschine unter Kraftaufwand zu transportieren, kann sie umkippen und Verletzungen herbeiführen.

Vor Inbetriebnahme

Dieser Abschnitt erläutert Vorsichtsmaßnahmen, die vor der Benutzung der Maschine zu beachten sind.

Aufstellungsort

Beachten Sie die folgenden Sicherheitshinweise.

- **Der Aufstellungsort zur Installation der Maschine wird bei der Anlieferung in Absprache mit dem Kunden festgelegt.**
- **Wenn Sie die Maschine an einen anderen Ort verlegen, benachrichtigen Sie zuvor die Servicestelle.**
- **Vermeiden Sie die Installation der Maschine an folgenden Orten. Andernfalls kann es zu Fehlfunktionen, Störungen oder Unfällen kommen.**
 - Vermeiden Sie Orte, die direktem Sonnenlicht oder starkem Lichteinfall ausgesetzt sind, etwa neben einem Fenster
(Ist dies unvermeidlich, bringen Sie Vorhänge zum Abdunkeln des Fensters an.)
 - Orte, die plötzlichen Temperaturschwankungen ausgesetzt sind
 - Sehr heiße und feuchte oder sehr kalte und trockene Orte
 - Orte nahe offener Feuerstellen oder Hitzequellen
 - Beheizte Stellen oder Orte, die direkter Kaltluft von Klimaanlage oder Heißluft sowie abgestrahlter Wärme von Heizkörpern ausgesetzt sind
 - Schlecht belüftete Orte
 - Staubige Orte
 - Orte, die vielen Vibrationen ausgesetzt sind
- **Installieren Sie die Maschine an einer ebenen Stelle, die folgenden Anforderungen entspricht.**

Oberflächenhöhe zur Installation: 2 Grad oder weniger
- **Betreiben Sie die Maschine unter folgenden Umgebungsbedingungen.**

Temperaturbereich: 15 °C bis 30 °C
Feuchtigkeitsbereich: 40% bis 70% RF (nicht kondensierend)

Netzanschluss

Beachten Sie die folgenden Sicherheitshinweise.

- **Schließen Sie das Stromkabel fest in den optionalen Netzanschluss der Druckereinheit, um einen Wackelkontakt zu vermeiden.**
- **Installieren Sie die Maschine in der Nähe einer Stromsteckdose.**
- **Wenn der Hauptschalter des Geräts eingeschaltet ist, wird das Gerät mit dem Ein- und Ausschalten des Druckers ein- und ausgeschaltet.**

Abmessungen

■ Drucker und Wrapping Envelope Finisher

Schaffen Sie ausreichend Platz, um die Maschine bedienen, das Material ersetzen und die Maschine warten zu können.

- Von Vorne gesehen

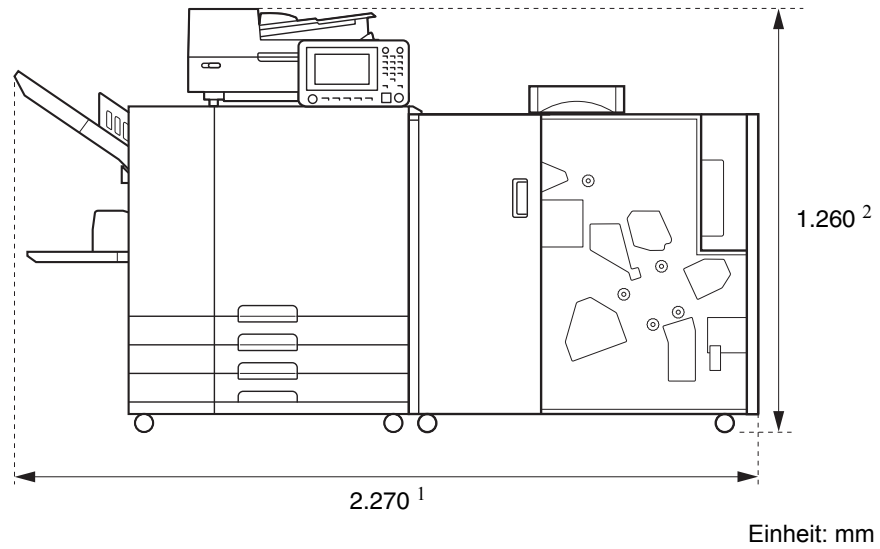

- Von der Seite gesehen

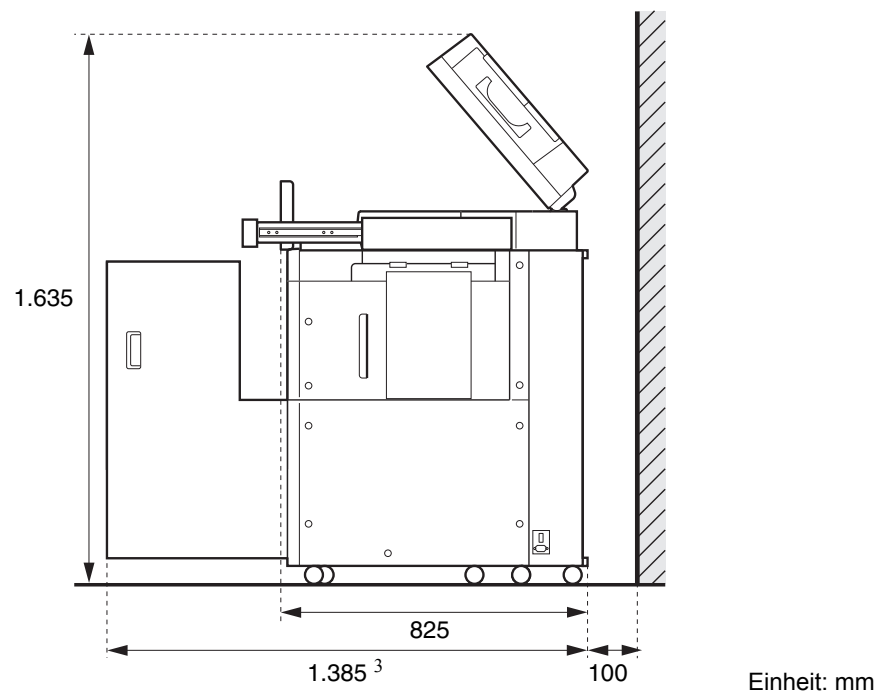

Die Größe hängt von den verwendeten optionalen Geräten ab.

1 Breite	Drucker und Wrapping Envelope Finisher	2.270 mm
	+ Scanner (bei Nutzung des Scanner-Stands)	2.270 mm
	+ Versatz-Hefter	2.490 mm
	+ Zufuhr mit hoher Kapazität	2.615 mm
2 Höhe	Keine Optionen (in einem Zustand mit um 90 Grad aufgerichtetem Bedienfeld)	1.160 mm
	Drucker, Wrapping Envelope Finisher und Scanner (bei Nutzung des Spezial-Scanner-Stands)	1.260 mm
	Drucker, Wrapping Envelope Finisher und Versatz-Hefter	1.345 mm
3 Tiefe	Keine Optionen (in einem Zustand mit um 90 Grad aufgerichtetem Bedienfeld)	1.280 mm
	+ Scanner (bei Nutzung des Scanner-Stands, in einem Zustand mit um 90 Grad aufgerichtetem Bedienfeld)	1.385 mm
	+ Zufuhr mit hoher Kapazität (in einem Zustand mit um 90 Grad aufgerichtetem Bedienfeld)	1.280 mm

Behandlung

- **Nutzen Sie den Hauptschalter nicht, um den Drucker oder die Maschine auszuschalten, und trennen Sie nicht das Netzkabel der Maschine während des Betriebs.**
- **Öffnen Sie keine der Abdeckungen während des Betriebs.**
- **Bewegen Sie die Maschine nicht.**
- **Das Gerät enthält Präzisionskomponenten und bewegliche Teile. Führen Sie daher keine Vorgänge aus, die nicht in den Handbüchern beschrieben sind.**
- **Stellen Sie keine schweren Objekte auf die Maschine oder setzen Sie die Maschine keinen starken Erschütterungen aus.**
- **Öffnen und schließen Sie die Abdeckungen behutsam.**
- **Schalten Sie die [Netz]-Taste am Bedienfeld AUS, bevor Sie die Hauptstromversorgung aus- und wieder einschalten.**

Verwendbares Papier

Um mit diesem Gerät ein Mail-Set zu erstellen, wird eine Umschlagform und ein Blatt (Blätter) für die Beilage(n) benötigt.

Um mit diesem Gerät einen Umschlag zu erstellen, verwenden Sie bitte die speziellen Umschlagformen von RISO. Diese Anleitung beschreibt das Verfahren, bei dem Umschlagformen von RISO angewendet werden.



- Diese Anleitung beschreibt das Verfahren, bei dem Umschlagformen von RISO angewendet werden.
- Weitere Informationen zu verwendbarem Papier finden Sie auch in den Handbüchern des Druckers der ComColor GD Serie.

Umschlagformen von RISO

Die Typen und Größen der Umschlagformen von RISO, die verwendet werden können, sind wie folgt.

Unterstützte Modelle	Wrapping Envelope Finisher G10 (E)	
Typen der Umschlagformen	Wrapping Envelope Form A	Wrapping Envelope Form B
Größe	233 mm × 296 mm	233 mm × 391 mm
Gewicht	Ca. 7,1 g / Blatt	Ca. 9,3 g / Blatt
Papierverzug	5 mm oder weniger	
Endmaß	233 mm × 110 mm	233 mm × 158 mm
Maximale Ladekapazität	Einzugsfach: Höhe bis zu 50 mm Standardfach: Höhe bis zu 110 mm Zufuhr mit hoher Kapazität (optional): Höhe bis zu 440 mm	
Anzahl der Beilagen (Bei Größe A4/B5/Letter)	hängt vom Gewicht des verwendeten Papiers ab. 46 g/m ² bis 59 g/m ² abt.: 6 Blätter oder weniger 60 g/m ² bis 80 g/m ² abt.: 5 Blätter oder weniger 81 g/m ² bis 100 g/m ² abt.: 4 Blätter oder weniger 101 g/m ² bis 120 g/m ² abt.: 3 Blätter oder weniger	
Größe des Beilagen-Papiers	A4 (210 mm × 297 mm), B5 (182 mm × 257 mm)	A4 (210 mm × 297 mm)
Falze des Beilagen-Papiers	Wickelfalz	2-fach



- Es ist erforderlich, im Voraus bei [Max. Beilagen] eine maximale Anzahl der Beilage-Blätter festzusetzen. Stellen Sie sicher, dass die Anzahl der Beilagen, die Sie einstellen, nicht die oben aufgeführte Beschränkung übersteigt. Falls diese Zahl nicht genau festgelegt ist, können die Beilagen das Limit überschreiten und es kann zu einem Papierstau kommen. Außerdem macht eine inkorrekte Einstellung die Umschläge dicker, was dazu führt, dass sich die Umschläge öffnen, nachdem sie gerade versiegelt wurden oder während Umschläge ausgegeben werden.
- Auch wenn die Anzahl der Beilagen nicht das oben angegebene Limit überschreitet, kann je nach Art des Beilagen-Papiers oder den Druckbedingungen ein Papierstau auftreten. Vergewissern Sie sich für das Drucken von Versandmaterial, dass kein Papierstau auftritt, indem Sie zunächst einen Testdruck durchführen.

Beilagen-Papier

Die Typen und Größen des Beilagen-Papiers, die verwendet werden können, sind im Folgenden aufgeführt.

Unterstützte Modelle	Wrapping Envelope Finisher G10 (E)
Typen der Umschlagformen	Glattes Papier, Recycle-Papier
Größe	B5 (182 mm × 257 mm) A4 (210 mm × 297 mm)
Papierfalz (keine gemischten Größen)	B5 (182 mm × 257 mm): Wickelfalz A4 (210 mm × 297 mm): 2-fach, Wickelfalz
Gewicht	Einzugsfach: 52 g/m ² bis 104 g/m ² Standardfach: 46 g/m ² bis 120 g/m ² Zufuhr mit hoher Kapazität (optional): 46 g/m ² bis 120 g/m ²
Papierverzug	3 mm oder weniger
Maximale Ladekapazität	Einzugsfach: Höhe bis zu 50 mm Standardfach: Höhe bis zu 110 mm Zufuhr mit hoher Kapazität (optional): Höhe bis zu 440 mm

Aufbewahren der Umschlagformen

- Achten Sie auf eine angemessene Betriebsumgebung und Lagertemperatur und verbrauchen Sie das Material so schnell wie möglich im Hinblick auf das Herstellungsdatum.
- Es wird empfohlen, alle Wrapping Envelope Forms auf einmal zu verwenden, wenn Sie die Schrumpfverpackung öffnen, um die Haftstärke des Klebers zu erhalten. Wenn einige Umschläge nicht verwendet werden, achten Sie darauf, sie mit der Markierung ★ nach oben in dem Aufbewahrungsbehälter zu lagern und alle innerhalb eines Monats aufzubrauchen.
- Die Wrapping Envelope Forms bitte nicht der Luft ausgesetzt lagern. Die Wrapping Envelope Forms können sich verformen und die Haftstärke des Klebers kann sich aufgrund von Temperatur, Luftfeuchtigkeit, ultravioletter Strahlung, Sauerstoff, Ozon, Staub oder anderer Gründe verschlechtern, was dazu führen kann, dass die Wrapping Envelope Forms nicht mehr verwendet werden können.
- Vermeiden Sie Orte, die direkter Sonneneinstrahlung, hohen Temperaturen und hoher Luftfeuchtigkeit ausgesetzt sind und lagern und verwenden Sie Wrapping Envelope Forms in einem Temperaturbereich von 15 bis 30 °C und in einem Luftfeuchtigkeitsbereich von 40 bis 70 %. Wenn Wrapping Envelope Forms bei einer Temperatur von 15 °C oder darunter verwendet werden, kann sich die Haftwirkung des rückbefeuchtenden Klebers verschlechtern, was dazu führt, dass sich versiegelte Umschläge wieder öffnen. Wenn Wrapping Envelope Forms bei 70 % relativer Luftfeuchtigkeit oder darüber verwendet werden, können sie zusammenkleben, was dazu führt, dass mehr als ein Umschlag gleichzeitig eingezogen wird.
- Lagern und verwenden Sie Wrapping Envelope Forms entfernt von Wärmequellen und an einem Ort, an dem die Forms keiner Zugluft von einem Klimagerät oder einem Luftreiniger ausgesetzt sind.

- Achten Sie darauf, dass Sie den Deckel des Kartons schließen und ihn an einem Ort lagern, der keiner direkten Sonneneinstrahlung ausgesetzt ist, nachdem Sie die Verpackung der Wrapping Envelope Forms geöffnet haben.

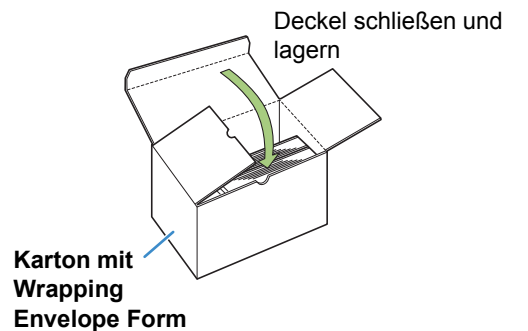

- Lagern Sie Wrapping Envelope Forms, deren Schrumpfverpackung noch nicht geöffnet wurde, in dem Karton.

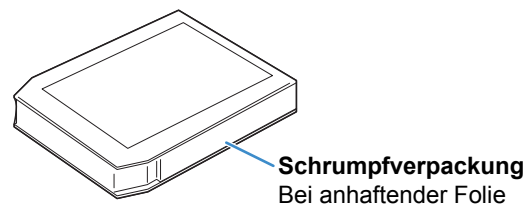

- Wenn Sie den Versiegelungsvorgang zwei Stunden oder länger unterbrechen möchten, entnehmen Sie die Wrapping Envelope Forms aus dem Drucker und lagern Sie sie in dem Aufbewahrungsbehälter.

Handhaben von versiegelten Mails

- Wenn Sie Umschläge (Mailing), die mit diesem Gerät versiegelt wurden, an einem Ort belassen, der direkter Sonneneinstrahlung ausgesetzt ist, kann dies dazu führen, dass sich die Umschläge öffnen. Versenden Sie die Umschläge sofort. Achten Sie darauf, den Status der Versiegelung vor dem Versenden zu überprüfen.
- Bitte achten Sie auf sorgfältigen Umgang mit vertraulichen Informationen beim Drucken und Kuvertieren mit dem Mail-Erstellers. RISO haftet nicht für Mails, deren Umschläge sich auf Grund von Verringerung der Klebekraft des Klebstoffes öffnen.
- Bitte für Anwendungen nutzen, in denen anzunehmen ist, dass die Post bei Zustellung am Zielort geöffnet wird.

Hinweise zur Verwendung und Lagerung des Aufbewahrungsbehälters

- Verwenden Sie den Aufbewahrungsbehälter an einem Ort, an dem er keiner direkten Sonneneinstrahlung ausgesetzt ist.
- Wenn Sie Wrapping Envelope Forms verwenden, die in dem Aufbewahrungsbehälter gelagert wurden, erstellen Sie mit dem obersten Form eine Testversion. Lassen Sie ausreichend Zeit, damit die Umschlagklappe trocknen kann, und prüfen Sie den Status der Versiegelung des Haftklebers sowie des rückbefeuchtenden Klebers, bevor Sie die übrigen Wrapping Envelope Forms verwenden. Wenn die Testversion nicht ausreichend versiegelt ist, hat sich die Haftstärke des Klebers verschlechtert. Verwenden Sie die übrigen Wrapping Envelope Forms nicht.
- Um das Datum leichter im Auge behalten zu können, wenn die Schrumpfverpackung geöffnet wurde, sollten Sie darauf achten, dass Sie keine Formen im Aufbewahrungsbehälter vermischen, die zu unterschiedlichen Daten geöffnet wurden.

Aufbewahrungsbehälters

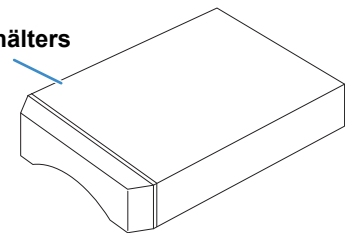

Technische Daten

■ Technische Daten des Wrapping Envelope Finisher G10 (E)

Grundfunktionen und Mail-Erstellungsfunktion

Modell		Wrapping Envelope Finisher G10 (E)	
Typ		In-Line versiegeltes Mail-Erstellungssystem	
Endbearbeitungstyp		Versiegelte Mail-Erstellung	
Spezialpapier für Umschläge		Wrapping Envelope Form A: 233 mm × 296 mm Ca. 105 g/m ²	Wrapping Envelope Form B: 233 mm × 391 mm Ca. 105 g/m ²
Beilagen-Papier	Papiergröße	A4 (210 × 297 mm), JIS-B5 (182 × 257 mm)	
	Papiertyp und -gewicht	Standardfach	Glattes Papier, Recycle-Papier Papier mit 46 g/m ² bis 120 g/m ²
		Einzugsfach	Glattes Papier, Recycle-Papier Papier mit 52 g/m ² bis 104 g/m ²
Bedruckbarer Bereich		Spezialpapier für Umschläge ¹	Maximal: 212 mm × 217 mm
		Garantierter Druckbereich für Beilagen	Standard: Perimeterspielraum von 3 mm Maximal: Perimeterspielraum von 1 mm
Papierfachkapazität	Standardfach	Spezialpapier für Umschläge ¹ : Höhe bis zu 110 mm Spezialpapier für Beilagen: Höhe bis zu 110 mm	
	Einzugsfach	Spezialpapier für Umschläge ¹ : Höhe bis zu 50 mm (3 Ablagen) Spezialpapier für Beilagen: Höhe bis zu 50 mm (3 Ablagen)	
	Zufuhr mit hoher Kapazität (optional)	Spezialpapier für Umschläge ¹ : Höhe bis zu 440 mm Spezialpapier für Beilagen: Höhe bis zu 440 mm	
Maximale Traglast der Mail-Ablage		Höhe bis zu 310 mm (Ca. 110 Mails: IJ-Papier (85 g/m ²)/1 Blatt Beilage mit Wickelfalz)	
Anzahl der Beilagen-Blätter		46 g/m ² bis 59 g/m ²	6 Blätter oder weniger
		60 g/m ² bis 80 g/m ²	5 Blätter oder weniger
		81 g/m ² bis 100 g/m ²	4 Blätter oder weniger
		101 g/m ² bis 120 g/m ²	3 Blätter oder weniger
Klebemethode		Mail Querformat	Druck-Klebemethode bei haftklebestoffbeschichteter Fläche.
		Mail Längsformat	Nassbeschichtungs-Klebemethode bei mit rückbefeuchtendem Kleber beschichteter Fläche.
Rückbefeuchtender Kleber		Nachfüllmethode	Nachfüllen vom Wasserbehälter (demontierbar)
		Kapazität des Wasserbehälters	400 ml
		Kapazität des Wasserbehälters im Drucker	480 ml
Fertiges Produkt Mailgröße		Wrapping Envelope Form A: 233 mm × 110 mm Wrapping Envelope Form B: 233 mm × 158 mm	
Bearbeitungsgeschwindigkeit ²		40 mails/Min. für A4 simplex	
Stromversorgung		Wechselstrom 100-240 V, 3,0-1,5 A, 50-60 Hz	
Stromverbrauch		Max. 250 W Ready: 40 W oder weniger Standby: 0,5 W oder weniger	

Betriebsgeräusch ³	68 dB (A) oder weniger
Betriebsumgebung	Temperatur: 15 °C bis 30 °C Luftfeuchtigkeit: 40% bis 70% RH (nicht kondensierend)
Gewicht ⁴	Ca. 161 kg
Sicherheitsinformationen	Entspricht mit der Norm IEC60950-1, Für den Einsatz in Innenräumen, Grad der Verschmutzung 2*, Höhenlage bis zu 2000 m * Grad der Umgebungsverschmutzung auf Grund von Schmutz und Staub in der Luft. Grad „2“ entspricht einer normalen Innenraumumgebung.
Abmessungen (B × T × H) ⁴	Wrapping Envelope Finisher: 990 mm × 710 mm × 960 mm
	Bei Anschluss am Drucker (in einem Zustand mit um 90 Grad aufgerichtetem Bedienfeld): 2.270 mm ⁵ × 1.280 mm × 1.160 mm

- 1 Wenn Wrapping Envelope Form A verwendet wird (ca. 105 g/m²)
- 2 Bei Verwendung von ComColor GD9630. Wenn 1 Blatt für A4 Einfachdrucken eingelegt wird
- 3 Wenn der Drucker angeschlossen ist und eine Umschlagform mit einer Beilage verschlossen wird
- 4 Ohne Aufbewahrungstasche
- 5 Wenn die Papierführung (Ende) gewinkelt angebracht ist (mit Ausnahme des Raums zum Entnehmen ausgeworfener Mail)

Hinweis für Mitgliedstaaten der Europäischen Union

RISO, die Umwelt und die Verordnung über Elektro- und Elektronik-Altgeräte (WEEE-Verordnung)

■ Was ist die WEEE-Verordnung?

Die WEEE-Verordnung soll Abfall reduzieren und sicherstellen, dass elektrische und elektronische Geräte am Ende ihrer Nutzungsdauer wiederverwertet werden.



■ Was bedeutet das Symbol einer durchgestrichenen Abfalltonne auf Rädern?

Das Symbol einer durchgestrichenen Abfalltonne auf Rädern bedeutet, dass dieses Produkt vom normalen Müll getrennt gesammelt werden muss.

Bitte wenden Sie sich an Ihren RISO-Kundendienst für weitere Informationen über die Entsorgung.

■ Was bedeutet das Balkensymbol?

Der Balken unter der durchgestrichenen Abfalltonne auf Rädern bedeutet, dass dieses Produkt nach dem 13. August 2005 auf den Markt gebracht worden ist.

■ An wen kann ich mich wenden, wenn ich mehr über die WEEE-Verordnung wissen möchte?

Für weitere Informationen sollten Sie sich an Ihren örtlichen RISO-Kundendienst wenden.

Riso Kagaku Corporation London Office, 610 Centennial Park, Centennial Avenue, Elstree, Herts, WD6 3TJ U.K.

Hinweise zu Markenzeichen

Microsoft, Windows und Microsoft Word sind entweder eingetragene Marken oder Marken der Microsoft Corporation in den Vereinigten Staaten und/oder anderen Ländern.

 RISO, ComColor und FORCEJET sind Markenzeichen oder eingetragene Markenzeichen von RISO KAGAKU CORPORATION in den USA und anderen Ländern.

Alle anderen Produkt- und Unternehmensnamen in diesem Dokument sind Markenzeichen oder eingetragene Markenzeichen der jeweiligen Unternehmen.



Please contact the following for supplies and service: