



RISO SF **EII** Series

User's Guide

SF 5450 **EII** **SF 5430 **EII****
SF 5350 **EII** **SF 5330 **EII****
SF 5250 **EII** **SF 5230 **EII****
 SF 5130 **EII**
 SF 5030 **EII**

About This Machine	1
Basic Operations	2
Functions for Master Making	3
Functions for Printing	4
Useful Functions	5
Setting the Operation Conditions	6
RISO Console	7
Replacing Consumables	8
Maintenance	9
Troubleshooting	10
Appendix	11

The “Basic Guide”, which supports the Read Out Loud feature in Adobe Acrobat Reader, is stored in the attached “RISO Printer Driver & User Guides” DVD-ROM. It contains excerpts from the User’s Guide (this guide) explaining the basic operations for printing using paper originals.

Directory:
\\UsersGuide_Printer\RISO SF5x50EII_SF5x30EII\English\
BasicGuide_RISO SF5x50EII_SF5x30EII_ENG.pdf

Recommended operating environment for Read Out Loud:
– Windows 10
– Adobe Acrobat Reader DC



As an **ENERGY STAR**[®] Partner, RISO KAGAKU CORP. has determined that this product meets the **ENERGY STAR**[®] guidelines for energy efficiency.

The International ENERGY STAR Program is an international energy-saving program implemented in the United States, Canada, Japan, EFTA, Switzerland, and Taiwan.

For SF5450EIIU, SF5430EIIU and SF5130EIIU
Duplicator Model: SF5450EIIU, SF5430EIIU and SF5130EIIU
RFID System Model: 050-34901
Contains FCC ID: RPARFR6

This device complies with Part 15 of the FCC Rules. Operation is subject to the following two conditions: (1) this device may not cause harmful interference, and (2) this device must accept any interference received, including interference that may cause undesired operation.

The user is cautioned that unauthorized changes or modifications not approved could void the user's authority to operate the equipment.

NOTE: This equipment has been tested and found to comply with the limits for a Class B digital device, pursuant to part 15 of the FCC Rules. These limits are designed to provide reasonable protection against harmful interference in a residential installation. This equipment generates, uses and can radiate radio frequency energy and, if not installed and used in accordance with the instructions, may cause harmful interference to radio communications. However, there is no guarantee that interference will not occur in a particular installation. If this equipment does cause harmful interference to radio or television reception, which can be determined by turning the equipment off and on, the user is encouraged to try to correct the interference by one or more of the following measures:

- Reorient or relocate the receiving antenna.
- Increase the separation between the equipment and receiver.
- Connect the equipment into an outlet on a circuit different from that to which the receiver is connected.
- Consult the dealer or an experienced radio/TV technician for help.

Contains IC: 4819A-RFR6

Operation is subject to the following two conditions: (1) this device may not cause interference, and (2) this device must accept any interference, including interference that may cause undesired operation of the device.

CAN ICES-3(B)/NMB-3(B)

Perchlorate Material-special handling may apply, See www.dtsc.ca.gov/hazardouswaste/perchlorate
This product may contain certain substances which are restricted when disposed.
Therefore, be sure to consult your contracted service dealer.

For SF5350EIIIE, SF5230EIIIE and SF5030EIIIE

This product contains RFID (Radio Frequency Identification) System.



RE directive Class1 device

Nur SF5350EIIIE, SF5230EIIIE und SF5030EIIIE
MASCHINENLÄRMINFORMATION

Maschinenlärminformations-Verordnung 3. GSGV:

Der höchste Schalldruckpegel beträgt 70 dB(A) oder weniger gemäß EN ISO 7779.

Hinweis:

Das Gerät ist nicht für die Benutzung am Bildschirmarbeitsplatz gemäß BildscharbV vorgesehen.

RISO KAGAKU CORPORATION LONDON OFFICE

610 Centennial Park, Centennial Avenue, Elstree, Herts, WD6 3TJ U.K.

For SF5350EIIA, SF5250EIIA, SF5330EIIA, SF5230EIIA, SF5130EIIA and SF5030EIIA

Warning

This is a Class A product. In a domestic environment this product may cause radio interference in which case the user may be required to take adequate measures.

Preface

Thank you for your purchase of this printing machine.

This machine is a digital duplicator that enables clear printing by using simple operations as if you are operating a copying machine.

You can print multiple sheets quickly at a low cost.

This machine is equipped with many useful functions that only duplicators can provide.

■ Descriptive contents in this guide

- The reproduction of this guide in whole or in part is strictly prohibited without the permission of RISO KAGAKU CORPORATION.
- The contents of this guide are subject to change in the future without prior notice for improvement of the product.
- Please note that we do not assume any responsibility for the effect of outcomes resulting from the use of this guide and the operation of this machine.

■ Trademarks

- , **RISO** and **RISO iQualitySystem** are trademarks or registered trademarks of RISO KAGAKU CORPORATION in the United States and other countries.
- Microsoft and Windows are either registered trademarks or trademarks of Microsoft Corporation in the United States and/or other countries.
- Other corporate names and/or trademarks are either registered trademarks or trademarks of each company, respectively.



This machine is certified for being manufactured in consideration of Color Universal Design, which improves visibility for more people regardless of individual differences in color perception, by the Color Universal Design Organization (CUDO).

About the User's Guides

User's guides provided for this machine

This machine comes with the following user's guides.

Thoroughly read these user's guides before using this machine.

In addition, read them whenever necessary in case there is anything unclear during the use of this machine. We hope that you will continuously use these guides together with this machine.

■ RISO SF EII Series User's Guide (this guide)

This user's guide explains the basic operation procedures of this machine and also explains how to use advanced printing functions and other useful functions.

It also explains precautions for use, how to handle and replace consumables, and troubleshooting procedures for cases in which a problem occurs.

■ RISO SF EII Series Basic Guide (Read Out Loud)

This guide is included as a PDF file on the attached "RISO Printer Driver & User Guides" DVD-ROM.

It contains excerpts from the User's Guide (this guide) explaining the basic operations for printing using paper originals. It supports the Read Out Loud feature in Adobe Acrobat Reader.

Directory:

\UsersGuide_Printer\RISO SF5x50EII_SF5x30EII\English\BasicGuide_RISO SF5x50EII_SF5x30EII_ENG.pdf

Recommended operating environment for Read Out Loud:

- Windows 10
- Adobe Acrobat Reader DC

■ RISO Printer Driver User's Guide

This user's guide is included as a PDF file on the attached DVD-ROM.

It explains the operation procedures for printing on this machine from a computer and various settings.

■ RISO Utility Software User's Guide

This user's guide is included as a PDF file on the attached CD-ROM.

It explains how to use the RISO COPY COUNT VIEWER and RISO USB PRINT MANAGER.

About symbols



Warnings or precautions for ensuring safety.



Important matters that require special attention. Read carefully and follow the instructions.



Supplemental explanation that provides useful information.



Indicates reference pages.

About screens and illustrations

The screens and illustrations provided in this guide may vary depending on usage environment factors such as the model and installation conditions of optional parts.

Contents

Preface	1
About the User's Guides	2
User's guides provided for this machine	2
About symbols.....	2
About screens and illustrations.....	2
Contents	3
Safety Precautions	7
Warning indications	7
Installation location.....	7
Power connection.....	7
Ground connection.....	7
Machine handling	8
Ink	8
Locations of caution labels.....	9
Before Starting Use	9
Precautions for installation.....	9
Precautions for use.....	10
Consumables	10
Printing of original data	11
Software	11
Originals	12
Printing papers.....	12
Printing area.....	14
Materials not to be printed.....	14

Chapter 1 About This Machine

Name and Function of Each Part	16
Paper feeding side.....	16
Paper receiving side.....	17
Option.....	18
Control panel.....	19
Liquid Crystal Panel Displays	21
Master making basic screen.....	21
Print basic screen.....	21
Printing Flow	22
"Master making process" and "Printing process"	22
What is [Auto Process]?.....	22

Chapter 2 Basic Operations

Preparation before Printing	24
Setting up the paper feed tray and the paper	24
Setting up the paper receiving tray	25
Placement of Originals	28
When using the glass platen	28
When using the auto document feeder	28
Printing of Paper Originals	29

Printing from Computer	30
When [Auto Process] is set to other than [ON].....	31
Printing by Using the USB Flash Drive	32
Performing authentication before using this machine	34
Performing authentication operation.....	34
Releasing the authentication status.....	35

Chapter 3 Functions for Master Making

Functions for Master Making	38
Image Processing That Is Suitable for the Original [LINE/PHOTO] [PENCIL]	38
[LINE/PHOTO].....	38
[PENCIL].....	39
Selecting a Method to Process the Gradation of Photos [Dot Process]	39
Adjusting the Scanning Level of the Original [SCANNING LEVEL]	40
Using a Book Type Original [BOOK]	40
Saving Ink [INK SAVING]	41
Enlarging or Reducing the Size of the Original [Size]	41
[Standard ratio].....	41
[Zoom].....	42
Laying Out Two Copies of Originals on a Single Sheet of Paper [2-UP]	42

Chapter 4 Functions for Printing

Functions for Printing	46
Adjusting the Print Speed [SPEED]	46
Adjusting the Print Density [DENSITY]	47
Adjusting the Print Position [PRINT POSITION]	48
Adjusting the position in the horizontal direction.....	48
Adjusting the position in the vertical direction.....	48

Chapter 5 Useful Functions

Useful Functions	52
Printing the Sorted Originals [Program]	52
Setting [Single Page Mode].....	53
Setting [Multi-Page Mode].....	53
Canceling [Program].....	54
Registering [Program].....	54
Retrieving [Program].....	54
Changing the settings of [Program].....	55
Erasing [Program].....	55
Preventing Blurring of Ink [IDLING]	56
Preventing Copying of Confidential Documents [CONFIDENTIAL]	56

Chapter 6 Setting the Operation Conditions

Setting the Operation Conditions [Custom Setting Mode]	58
---	-----------

Basic operation of [Custom Setting Mode]	58
List of setting items	59
Connecting to the Network	68
When connecting to the IPv4 network	68
When connecting to the IPv6 network	69
Using the Authentication Function	70
[User Registration]	70
[Disable]	71
[Limit T/C] [Limit M/C]	72
[Clear T/C] [Clear M/C]	72
[Reset Counter]	73
[Set Date]	73
[Clear Count Error]	74
[Count Report Output]	74
[Setting of Count Report]	75
[Clear Authentication Setting]	76
Displaying the Accumulated Counts [Meter Display]	77
Adjusting Paper Feeding and Receiving Conditions [Special Paper Control]	78
Paper feeding adjustment for special paper [Paper Quality]	78
Paper receiving adjustment for special paper [Separation Fan] [Suction Fan]	78
Inserting Slip Sheet [Slip Sheet Sorting]	79
Using Paper Memory Original [Paper Memory Print]	79

Chapter 7 RISO Console

RISO Console	84
Accessing RISO Console	84
Logging in	84
Logging out	84
[Monitoring] Menu	85
[General] tab screen	85
[System] tab screen	85
[User] tab screen	85
[Printer] Menu	86
[Network] Menu	87
[Network setting] screen	87
[SNMP Setting] screen	87
[SMTP Setting] screen	87

Chapter 8 Replacing Consumables

Setting the Master Roll	90
Replacing the Ink Cartridge	92
Emptying the Master Disposal Box	94
Replacing the Print Drum (Cylinder)	95
Removing the print drum (cylinder)	95
Installing the print drum (cylinder)	96
Collecting and Disposing of Depleted Consumables	97
Ink cartridge	97

Master core	97
Used master	97

Chapter 9 Maintenance

Maintenance	100
Thermal print head	100
Exterior	101
Glass platen and platen cover pad	101
Optional Auto Document Feeder	102
Pressure roller	102

Chapter 10 Troubleshooting

When a Message Is Displayed.....	104
How to view the message	104
Message	105
When the [■] indicator blinks and [H] is displayed in the numeric display	113
When the [■] indicator goes off and an error code is displayed in the numeric display	114
Troubleshooting	115

Chapter 11 Appendix



Optional Accessories	124
Specifications	125
Index.....	131

Safety Precautions





This section describes the information that you need to be aware of before using this machine. Read this section before operating this machine.

Warning indications

The following warning indications are used to ensure proper operation of this machine and also to prevent hazards to the human body and damage to property.

 Warning	Indicates that incorrect handling by ignoring this symbol may cause death or serious human injury.
 Caution	Indicates that incorrect handling by ignoring this symbol may cause human injury or damage to properties.

Example of pictorial indication

	The  symbol indicates prohibited actions. The specific actions that are prohibited are indicated within the pictograph or in an adjacent area. The pictograph shown on the left indicates prohibition of disassembly.
	The  symbol indicates mandatory actions or instructions. The specific instructions are indicated within the pictograph. The pictograph shown on the left asks you to unplug the power cord.



Installation location

Caution

- Do not place this machine on an unstable location, such as a wobbly base or tilted surface. If this machine falls down or falls over, the situation may result in injury.
- Keep this machine away from humid and dusty environments. Failure to do so may result in fire or electric shock.

Power connection

Warning

- Use this machine in accordance with the rated voltage value. Also, use this machine by connecting it to an electrical outlet with a capacity larger than the rated current value. For the rated voltage and rated current values, check the item "Power Source" in the table of specifications at the end of this guide.
- Do not use a branching outlet or multiple outlet extension plug. It may result in fire or electric shock. 
- Do not scratch, damage, or process the power cord. Do not damage the power cord by placing heavy objects on it or pulling or forcibly bending it. It may result in fire or electric shock. 
- The provided power cord is dedicated for this machine. Do not use it for other electrical products. It may result in fire or electric shock.
- Do not plug or unplug the power cord with wet hands. It may result in electric shock.

Caution

- When unplugging, do not pull the power cord (be sure to hold the plug). It could damage the cord, and this may result in fire or electric shock.
- If this machine is not used for a long time due to consecutive holidays, etc., be sure to unplug the power cord to ensure safety.
- Unplug the power cord at least once a year and clean the prongs of the plug and their surroundings. Dust collected on these areas may result in fire.



Ground connection

Warning

- Be sure to insert the power plug with a ground conductor into the wall outlet with a ground receptacle.  Do not use the machine if it is not grounded. It may result in fire or electric shock.

Machine handling

Warning

- Do not place a container that is filled with water or metallic objects on this machine. If the water spills or the water or metallic objects fall into this machine, it may result in fire or electric shock.
- Do not use combustible spray and flammable solvent near this machine. If the sprayed gas or flammable solvent contacts the electrical parts inside the mechanical system, it may result in fire or electric shock.
- Do not insert or drop foreign matter, such as metallic parts or highly combustible matter, into this machine through any opening. It may result in fire or electric shock.
- Do not remove the covers of this machine. There are some sections to which high voltage is applied inside this machine. Removing the covers may result in electric shock.
- Do not disassemble or modify this machine. It may result in fire or electric shock. 
- If this machine emits excessive heat, smoke or foul odor, immediately turn off the power switch, unplug the power cord, and consult your dealer or authorized service representative. Failure to do so may result in fire or electric shock. For more information, consult your dealer or authorized service representative. 
- If foreign matter enters this machine, immediately turn off the power switch of the main unit, unplug the power cord and consult your dealer or authorized service representative. If you continue to use this machine without taking appropriate measures, it may result in fire or electric shock. 

Caution

- When you want to move this machine, consult your dealer or authorized service representative. Forcibly moving this machine by yourself could topple the machine over, and may result in injury.
- Do not perform any procedures (adjustment, repair, etc.) that are not described in this guide. When you want to adjust or repair, consult your dealer or authorized service representative.
- Allow plenty of ventilation during printing.
- Do not directly touch the thermal print head with your fingers. The thermal print head may be heated and cause burns.
- Do not touch the sections currently in operation in this machine. It may result in injury.
- Do not stick body parts such as your fingers into the openings around the paper feed tray or the paper receiving tray. It may result in injury.
- When you put your hands inside the main unit, take care not to touch any protrusions or edges of the metal plate. It may result in injury.
- When you put your hands inside the main unit, take care not to touch the paper separation hook or master removal hooks. The sharp tips of these hooks can hurt your hands. 
- Be sure to turn off the power to this machine when cleaning the pressure roller.
- Ink may be left on the areas near the print drum (cylinder) and the inside of the main unit after the print drum (cylinder) unit has been removed. Take care not to smudge your hands or clothes with the ink. Wash immediately with soap if you get ink on your hands, etc.
- Do not stand the print drum (cylinder) vertically. Doing so may stain the floor, etc.

Ink

Caution

- If ink gets in your eyes, immediately rinse it off completely with a large amount of water.
- If it gets on your skin, wash it off thoroughly using soap.
- If it is swallowed by accident, do not induce vomiting. Instead, drink a large amount of water or milk, and see if the condition improves.
- If you feel any abnormalities, immediately seek medical treatment.
- Only use the ink for printing purposes.
- Keep the ink out of the reach of children.

Locations of caution labels

This machine has some caution labels to ensure safe operation. Follow the indications of those labels and use this machine safely.

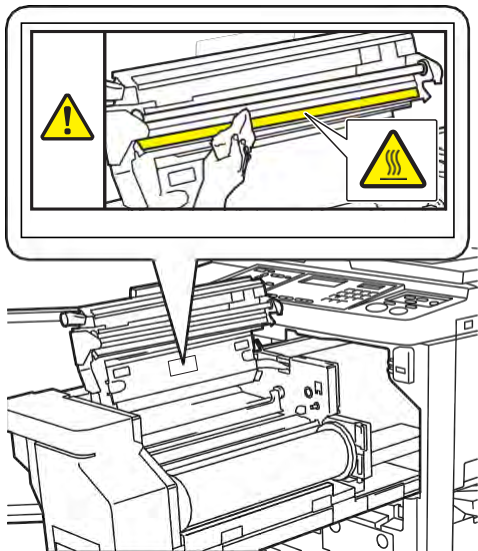

Before Starting Use

This section describes the precautions to be observed and the information that you need to be aware of before using this machine.

Precautions for installation

■ Required space

This machine requires the following space.

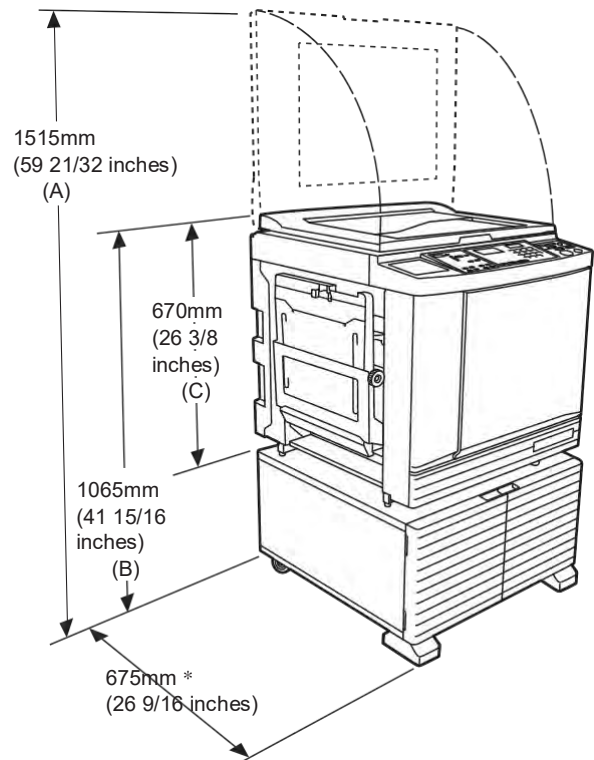

When the optional auto document feeder is installed, the values of (A) to (C) in the figure above are as follows.

- (A) 1440 mm (56 11/16 inches)
- (B) 1100 mm (43 5/16 inches)
- (C) 705 mm (27 3/4 inches)

* The depth of the main unit includes the dedicated rack (RISO Stand D Type III) and stabilizers.

Top view

- When in use

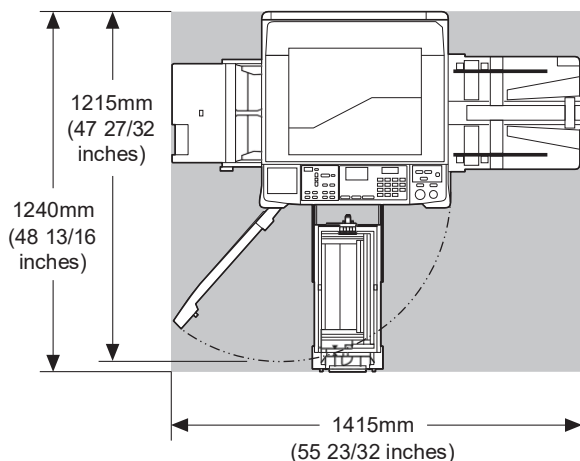

- When in storage

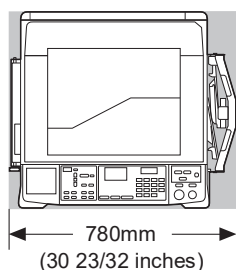

■ Installation location

- The installation location of this machine will be determined in consultation with you during delivery.
- The installation location of the machine should be fixed.
When you want to move this machine, consult your dealer or authorized service representative.
- Do not install this machine in the locations listed below. Failure to observe this precaution may result in malfunction, failure, or accident.
 - Locations with exposure to direct sunlight and locations close to windows (cover the windows with curtains if necessary)
 - Locations that are subject to sudden changes in temperature
 - Extremely hot and humid locations or cold and dry locations
 - Locations exposed to fire or heat, direct cold air (e.g., air conditioner), direct hot air (e.g., heater), or where heat is transmitted
 - Locations with poor permeability and ventilation
- Choose a location where this machine is level when it is installed. (Levelness for installation: 10 mm [25/64 inches] or less both lengthwise and widthwise)
- The appropriate environment conditions are as follows.
Temperature range: 15°C to 30°C (59°F to 86°F)
Humidity range: 40% to 70% (no condensation)



Precautions for use

■ Power connection

- Be sure to plug in the power cord securely to prevent poor contact in the power plug section.
- Locate this machine near the electric outlet.



■ Operations

- Do not turn off the power or unplug the power cord during operation.
- Do not open covers or move this machine during operation.
- Open and close covers gently.
- Do not put any heavy objects on this machine.
- Avoid excessive impact on this machine.
- This machine contains precision parts and drive mechanisms. Perform only the procedures described in this guide.

Consumables

- For the ink and master rolls, it is recommended to use the products specified by RISO.
- Genuine RISO inks and master rolls are engineered for maximum performance and maximum life, and RISO equipment is designed to give excellent performance when used with genuine RISO consumables.
However, all consumables can and do deteriorate over time. We recommend that you use ink and master rolls as soon as possible after purchase, and within 24 months of the date of manufacturing. You can find the date of manufacturing on the ink cartridge or the inside of master core. RISO genuine consumables transmit information regarding the age of the consumables that allows the machine to make adjustment based on the age of the consumables, e.g., time remaining until the Use By date.
- Store the paper, master rolls, and ink cartridges properly according to the instructions indicated on each container.
- Do not store those parts in the locations listed below.
 - Locations with exposure to direct sunlight and locations close to windows (cover the windows with curtains if necessary)
 - Locations that are subject to sudden changes in temperature
 - Extremely hot and humid locations or cold and dry locations



Printing of original data

The following methods are available for printing original data that was created using a computer.

■ Method to connect with the computer using a USB cable

A commercially available USB cable is required for connection. Use a cable of 3 m (10 feet) or shorter that conforms to the USB 2.0 standard.



B When connecting using a USB cable, be sure that the power for this machine and the computer is turned on.

B If you use a USB hub, the machine may not work properly.

B The maximum allowable voltage for USB port input and output is 5V.

■ Method to connect with the computer using a network

Use a commercially available Ethernet cable (shielded twist pair cable that supports 10BASE-T or 100BASE-TX).



B To connect the SF5430EII/SF5330EII/SF5230EII/SF5130EII/SF5030EII to the network, the optional network kit (A 124) is required.

■ Method to use a USB flash drive

- Use a USB flash drive that is compatible with the USB mass-storage device class. Some USB flash drives may not work properly.
- Use a USB flash drive that was formatted to FAT.
- A USB flash drive that features a security function may not work properly.



B Connect or disconnect the USB flash drive slowly according to the proper procedures. (A 32 “Printing by Using the USB Flash Drive”)

B We cannot guarantee data that is saved on the USB flash drive against loss that is caused by natural disasters or unforeseen events. We recommend that you use your computer to make back-up copies of any important documents.

■ Method for using a Paper Memory Original

- Convert the original data into a Paper Memory Original using the printer driver function of this machine, and then print the Paper Memory Original with a laser printer.
- Using the [Paper Memory Print] function (A 79), this machine can handle Paper Memory Originals.



B This machine may not be able to scan the Paper Memory Original properly in the following cases:

- The glass platen or platen cover pad is stained.
- The Paper Memory Original is stained, wrinkled, or creased.
- The Paper Memory Original has writing in an undesignated area (A 79).

Software

The software included in the DVD-ROM and the CD-ROM provided for this machine is as follows:

■ RISO Printer Driver

This is a dedicated printer driver that enables printing an original from a computer.

You can also convert original data created on a computer and create a Paper Memory Original for [Paper Memory Print] (A 79).

For more information, see the user's guide (PDF file) included in the DVD-ROM.

■ RISO Utility Software

The following two software programs are included in the CD-ROM:

- RISO USB PRINT MANAGER
You can manage the information of the original data in the USB flash drive on a computer.
- RISO COPY COUNT VIEWER
You can manage the copy count data that was saved in a USB flash drive by [Count Report Output] (A 74).
For more information, see the user's guide (PDF file) included in the CD-ROM.

Originals

■ Size and weight

The following sizes and weights of originals are usable:

When using the glass platen

Size	50 mm × 90 mm to 310 mm × 432 mm (1 31/32 inches × 3 17/32 inches to 12 7/32 inches × 17 inches)
Weight	10 kg (22 lb) at maximum

When using the optional auto document feeder

Size	100 mm × 148 mm to 300 mm × 432 mm (3 15/16 inches × 5 13/16 inches to 11 13/16 inches × 17 inches)
Weight	50 g/m ² to 128 g/m ² (13-lb bond to 34-lb bond)

- Do not mix originals of different sizes for the auto document feeder.
- You can place up to approximately 50 sheets of originals (when using originals of 80 g/m² [21-lb bond] or less) in the auto document feeder at the same time.



B The following originals cannot be used in the auto document feeder. Place the original on the glass platen.

- C Patched original
- C Excessively wrinkled, curled, or creased original
- C Original with sticky areas or holes
- C Torn original or deckle-edged original
- C Chemically treated original (such as thermal or carbon paper)
- C Transparent original (such as OHP films or tracing paper)
- C Original with correction fluid or glue
- C Extremely thin original (less than 50 g/m² [13-lb bond])
- C Extremely thick original (greater than 128 g/m² [34-lb bond])
- C Original with slippery surface (such as art or coated paper)
- C Original with glossy surfaces
- C Original with staples or clips

- If an original is excessively wrinkled, curled, or creased, flatten it thoroughly so that the entire original is securely placed on the glass platen. Areas that come off from the glass platen may be printed in black.
- If ink or correction fluid is used on an original, thoroughly dry it before placement. Failure to do so may contaminate the glass platen, and this impairs proper printing.

■ Direction of original

Each direction of an original is referred to as follows in this guide:

- When placing an original on the glass platen:
The side that faces the reference position (H symbol) is referred to as the “top”.

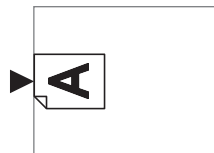

- When placing an original on the optional auto document feeder:
The leading edge in the feeding direction is referred to as the “top”.

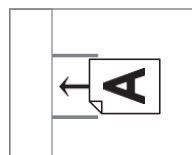

Printing papers

- If you use papers outside the specifications of this machine, RISO does not assure the paper feeding and printing performance with these papers.



B Please note that even with paper of a size and weight that conforms to the specifications of this machine, this machine may not feed the paper depending on the paper type, environmental conditions, and storage conditions. For more information, consult your dealer or authorized service representative.

■ Paper size

- The following sizes of paper are usable:
100 mm × 148 mm to 310 mm × 432 mm
(3 15/16 inches × 5 13/16 inches to
12 7/32 inches × 17 inches)
- This machine detects the following papers as standard size paper.

SF5450EII/SF5430EII/SF5130EII

Ledgerp	11 inches × 17 inches
Legalp	8 1/2 inches × 14 inches
Letterp	8 1/2 inches × 11 inches
Lettern	11 inches × 8 1/2 inches
Statement P	5 1/2 inches × 8 1/2 inches

SF5350EII/SF5250EII/
SF5330EII/SF5230EII/SF5030EII

A3p	297 mm × 420 mm (11 11/16 inches × 16 17/32 inches)
A4p	210 mm × 297 mm (8 1/4 inches × 11 11/16 inches)
A4n	297 mm × 210 mm (11 11/16 inches × 8 1/4 inches)
B4p	257 mm × 364 mm (10 1/8 inches × 14 11/32 inches)
B5p	182 mm × 257 mm (7 5/32 inches × 10 1/8 inches)
B5n	257 mm × 182 mm (10 1/8 inches × 7 5/32 inches)
Foolscap P	215.9 mm × 330.2 mm (8 1/2 inches × 13 inches)

■ Paper type

- The following paper types are usable:
SF5450EII/SF5350EII/SF5250EII
46g/m² to 210 g/m² (12-lb bond to 116-lb index)
SF5430EII/SF5330EII/SF5230EII/
SF5130EII/SF5030EII
46g/m² to 157 g/m² (12-lb bond to 42-lb bond)

■ To prevent paper jams and paper feeding failures

- Place the paper so that its grain (flow of the grain) is aligned with the paper feeding direction.
If the paper grain is set perpendicularly to the paper feeding direction, the resilience of the paper will decrease, and it may result in a paper jam.

RIGHT

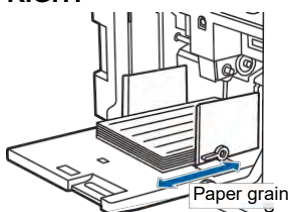

WRONG

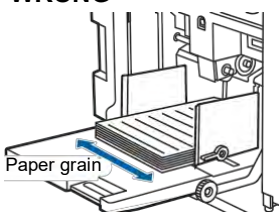

You can check the paper grain by tearing the paper. The direction in which the paper tears straight is the paper grain.



The paper tears straight if you tear it along the paper grain.



The paper does not tear straight if you tear it perpendicularly to the paper grain.

- When using poorly cut paper or coarse surfaced paper (drawing paper, etc.), separate the paper before use.

- Depending on the type of paper to be used, paper dust may be generated during use of this machine. Please clean and ventilate the area adequately.
- When using thick paper (drawing paper, etc.) or paper with a slippery surface, adjust the following parts:
 - For SF5450EII/SF5350EII/SF5250EII
 - The paper feed setting lever
 - The paper arrangers for the paper receiving tray
 - The adjustment dial for the paper jumping wings
 - For SF5430EII/SF5330EII/SF5230EII/SF5130EII/SF5030EII
 - The paper feed setting lever
 - The corrugators for the paper receiving tray (A 24 “Preparation before Printing”)
- Use flat paper. If it is unavoidable to use curled paper, place the printing paper so that the inner curled part faces up.



- If the margin at the top of the printed paper (leading edge in the paper output direction) is too small or if a highly dense image is located at the top of the printed paper, the paper may adhere to the print drum (cylinder). In this case, lower the print position to allow a larger margin at the top or rotate the top-and-bottom direction of the original, and then make a master again.

■ Paper storage

Store paper in a dry area. Paper containing moisture can result in paper jams or poor print quality.

■ Inappropriate paper for printing

Do not use the types of paper listed below, as it can result in a paper jam.

- Extremely thin paper (less than 46 g/m² [12-lb bond])
- Extremely thick paper (greater than 210 g/m² [116-lb index])
- Chemically treated paper (such as thermal or carbon paper)
- Excessively wrinkled, curled, creased, or torn paper
- Paper coated on one side or both sides
- Deckle-edged paper
- Art paper
- Paper with sticky areas or holes

■ Direction of paper

The leading edge in the paper feeding direction is referred to as the “Top” in this guide.

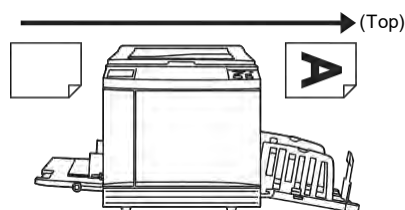

Printing area

■ Maximum Printing Area

The maximum printing area of this machine is as follows:

Model	Allowable printing range
SF5450EII/ SF5430EII	291 mm × 425 mm (11 15/32 inches × 16 23/32 inches)
SF5350EII/ SF5330EII	291 mm × 413 mm (11 15/32 inches × 16 1/4 inches)
SF5250EII/ SF5230EII	251 mm × 357 mm (9 7/8 inches × 14 1/16 inches)
SF5130EII	210 mm × 357 mm (8 1/4 inches × 14 1/16 inches)
SF5030EII	210 mm × 290 mm (8 1/4 inches × 11 13/32 inches)

■ Master making area

The master making area is determined according to the paper size placed on the paper feed tray. The master making area is an area that equals the paper size excluding the margin shown in the illustration below.

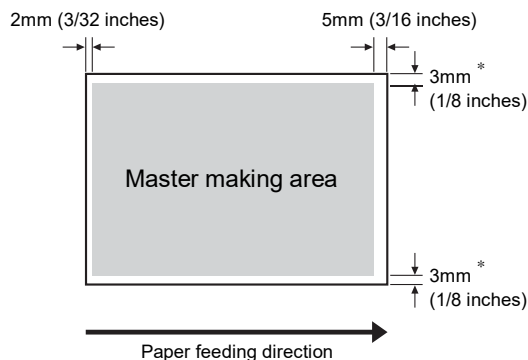

* These values are for cases when using standard size paper. When using custom size paper, these values are 5 mm (3/16 inches).

When creating originals, take above margins into consideration.

The same master making area is applied when printing by sending original data from a computer.



B The master making area does not exceed the maximum printing area even when you set large paper.



B When printing an original with little margin around the original, it is useful to reduce the original by setting the magnification rate (A 41).

Materials not to be printed

Do not use this machine in any manner which violates the laws or infringes on established copyrights, even when making copies for personal use. Consult your local authorities for further details. In general, use discretion and common sense.



Chapter **1**

1

About This Machine

Name and Function of Each Part

Paper feeding side

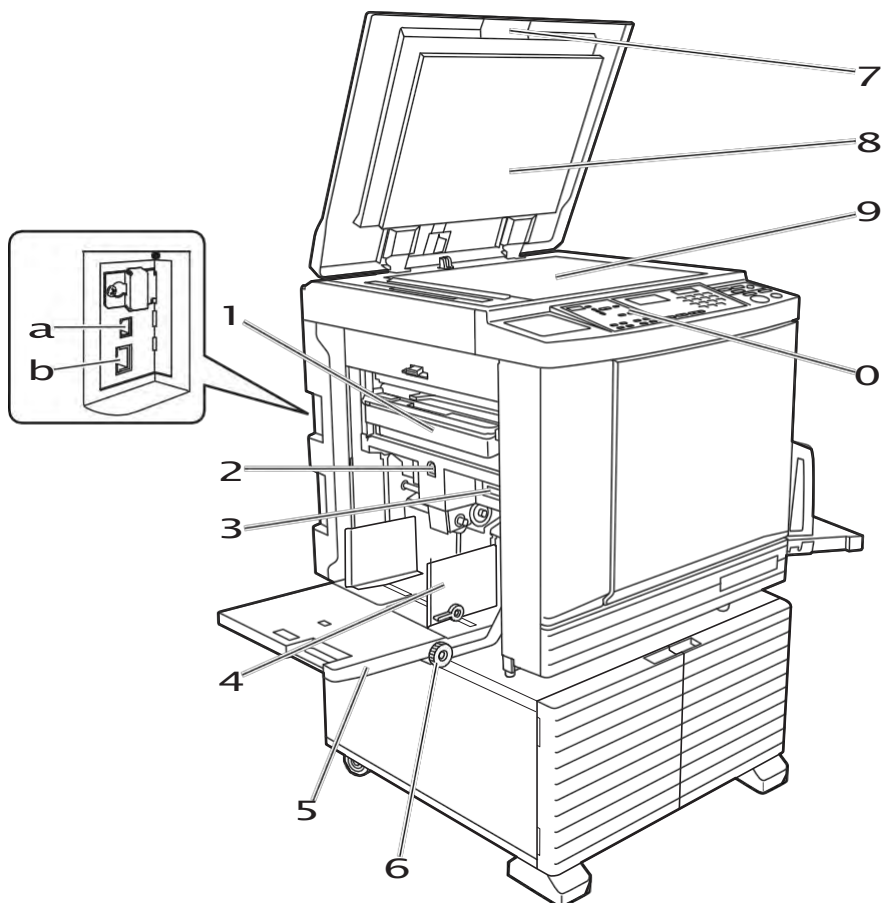

1 Master disposal box (A 94)

Collects masters that are disposed of.

2 Feed tray ascent / descent button (A 24)

Raises or lowers the paper feed tray when you replace or add the paper.

3 Paper feed setting lever (A 24)

Adjusts the paper-feed pressure according to the paper type.

4 Feed-tray paper guides (A 24)

Slide these guides to fit the paper width to prevent misalignment of the paper.

5 Paper feed tray (A 24)

Place the paper on this tray.

6 Vertical print position adjustment dial (A 48)

Adjusts the printing position in the vertical direction.

7 Platen cover (A 28)

Open / close this cover when placing an original.

8 Platen cover pad (A 101)

9 Glass platen (A 28)
Place the original facing down.

0 Control panel (A 19)
Perform the required operations.

a USB port (Type B) (A 11)
Plug in a USB cable to connect this machine with a computer.

b LAN port (A 11)
Plug in an Ethernet cable to connect this machine to the network.
Depending on the model, the optional network kit (A 124) is required.

Paper receiving side

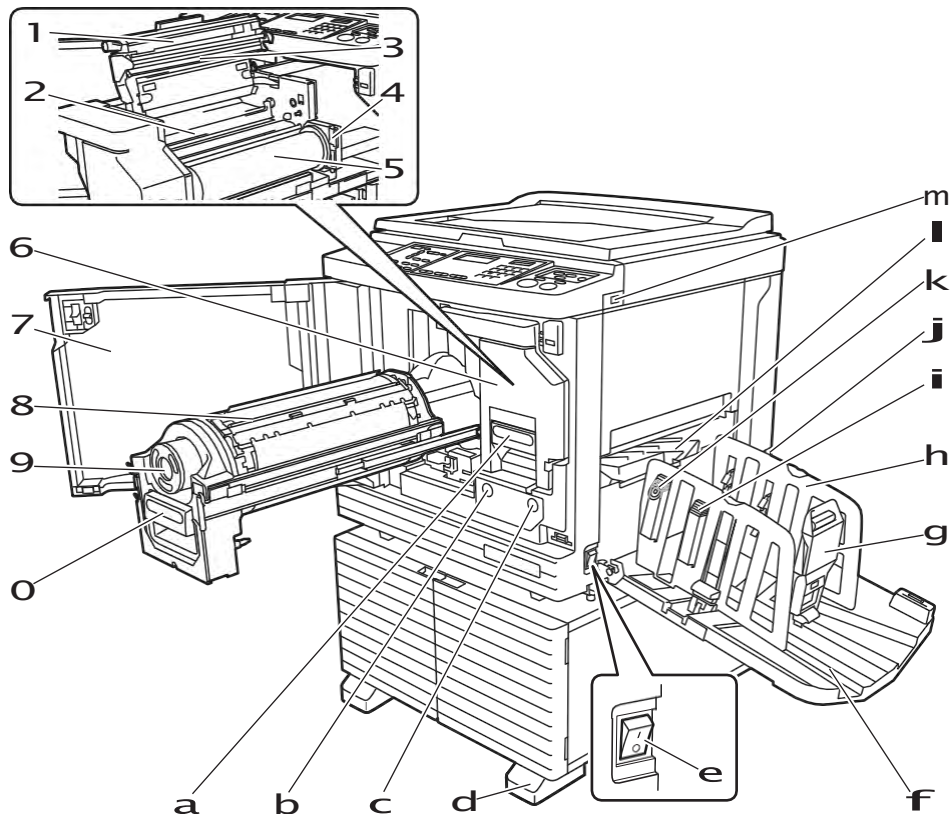

- 1 Master making unit cover (A 90)**
- 2 Master guide flap (A 91)**
- 3 Thermal print head (A 100)**
- 4 Master roll holder (A 91)**
Secures a master roll that is set.
- 5 Master roll (A 90)**
- 6 Master making unit (A 90)**
See numbers 1 to 5.
- 7 Front door (A 90)**
- 8 Print drum (cylinder) (A 95)**
- 9 Ink cartridge (A 92)**
- O Print drum (cylinder) handle (A 95)**
Grip this handle to pull out the print drum (cylinder).
- a Master making unit handle (A 90)**
Grip this handle to pull out the master making unit.
- b Print Drum (Cylinder) Release Button (A 95)**
You can pull out the print drum (cylinder) while this button is lit.
When the button is not lit, press the button to light it up and then pull out the print drum (cylinder).
- c Master Making Unit Release Button (A 90)**
You can pull out the master making unit while this button is lit.
When the button is not lit, press the button to light it up and then pull out the master making unit.
- d Stabilizer**
- e Power switch (A 29)**
Turn on/off the power supply.
- f Paper receiving tray (A 25)**
The printed paper is output to this tray.
- g Paper stopper (A 25)**
Slide this stopper to fit the paper size.
- h Receiving-tray paper guides (A 25)**
Slide these guides to fit the paper size.
- i Paper arranger knob (A 25)**
(Only for SF5450EII/SF5350EII/SF5250EII/SF5050EII)
Press this knob to open the paper arranger.
The paper arranger helps improve the arrangement state of the printed paper.
- j Voltage switch**
(Only for SF5430EII/SF5330EII/SF5230EII/SF5130EII/SF5030EII)
Do not touch the switch on the upper part of the AC inlet (power cord connection). Switching the voltage by mistake may result in malfunctions.
- k Adjustment dial for the paper jumping wings (A 26)**
(Only for SF5450EII/SF5350EII/SF5250EII/SF5050EII)
- l Paper jumping wing (A 26)**
- m USB port (A 32)**
Insert a USB flash drive for printing.

Option

■ Auto Document Feeder

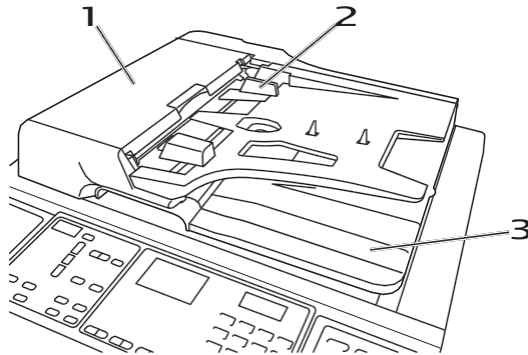

1 ADF cover ([A 112](#))

Open this cover when a paper jam occurs to remove the original.

2 ADF original guides ([A 28](#))

Slide these guides to fit the original width to prevent misalignment of the original.

3 ADF original receiving tray

The original that has been scanned is output to this tray.

Control panel

■ Main panel

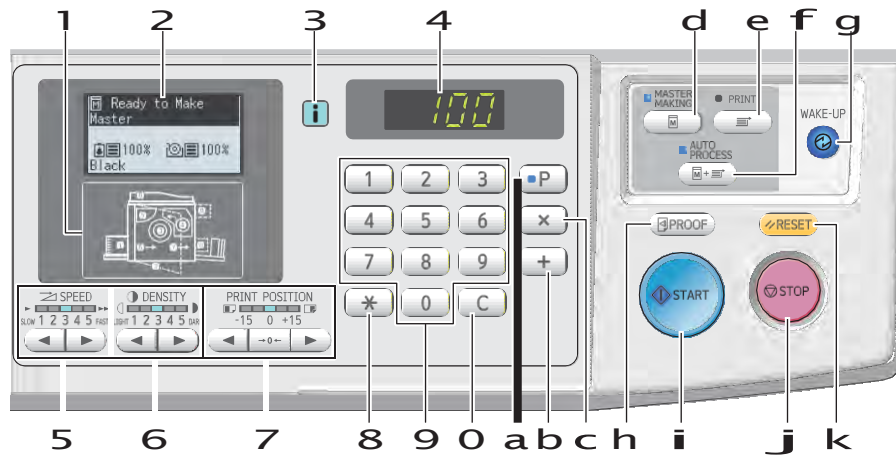

- 1 Error location indicator (A 105)**
Shows the location where an error is occurring.
- 2 Display (A 21)**
- 3 [I] indicator (A 105)**
The color of the [I] indicator shows the status of this machine.
- 4 Numeric display**
Shows the number of prints and the entered values for various settings.
- 5 [SPEED] keys (A 46)**
Press these keys to adjust the print speed. The lamp above these keys shows the current speed.
- 6 [DENSITY] keys (A 47)**
Press these keys to adjust the print density. The lamp above these keys shows the current print density.
- 7 [PRINT POSITION] keys (A 48)**
Press these keys to adjust the print position in the horizontal direction after master making.
- 8 [Q] key**
Press this key to register the [Program] (A 52) settings or open the [Program] screen.
- 9 Numeric keys**
Press these keys to enter the number of prints and the values for various settings.
- 0 [C] key**
Press this key to clear the entered characters and numbers.
- a [P] key (A 52)**
Press this key to open the [Program] screen. When [Program] is turned on, the key lamp is lit.
- b [+/-] key**
Press this key to operate [Program] (A 52) or [Custom Setting Mode] (A 58).
- c [X] key**
Press this key to operate [Program] (A 52) or [Custom Setting Mode] (A 58).
- d [MASTER MAKING] key (A 29)**
Press this key to display the master making basic screen.
- e [PRINT] key**
Press this key to display the printing process basic screen.
- f [AUTO PROCESS] key (A 22)**
Press this key to turn on / off [AUTO PROCESS]. When [AUTO PROCESS] is turned on, the lamp above the key is lit.
- g [WAKE-UP] key**
 - When this machine is in the sleep (power saving) status, the key lamp is lit. Press this key to activate this machine.
 - When the authentication function (A 70) is enabled, the key lamp is lit while the user is authenticated. Press this key to cancel the authentication status.
(A 35 "Releasing the authentication status")
- h [PROOF] key (A 29)**
Press this key to output a proof copy.
- i [START] key**
Press this key to start the master making process and the printing process as well as to start various operations.
The key lamp is lit when the operation is available and not lit when the operation is not available.
- j [STOP] key**
Press this key to stop the operation in progress. If this key is pressed while master making is in progress, the operation stops after the master making process is complete.
- k [RESET] key**
Press this key to reset the current setting to its default value or clear error displays after troubleshooting.

■ Sub panel

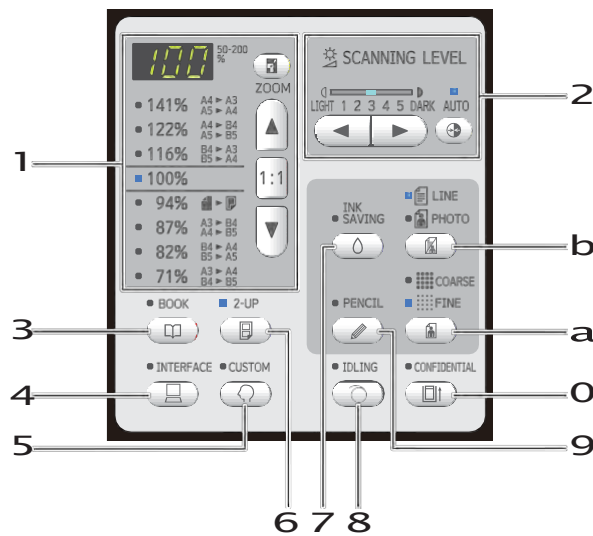

1 Reproduction size selection area (A 41)

You can set the magnification rate.

2 Scanning level adjustment area (A 40)

You can adjust the scanning level of the original.

3 [BOOK] key (A 40)

4 [INTERFACE] key (A 30)

Press this key before receiving the original data from the computer. When this key is turned on, the lamp above the key is lit.

5 [CUSTOM] key (A 58)

Press this key to change the default setting, etc. During setting, the lamp above the key is lit.

6 [2-UP] key (A 42)

Press this key to lay out two copies of originals side by side on a single sheet of paper. When this key is turned on, the lamp above the key is lit.

7 [INK SAVING] key (A 41)

Press this key to reduce the amount of ink consumption.

8 [IDLING] key (A 56)

You can reduce blurring of ink at the beginning of printing, for example, when the print drum (cylinder) has not been used for a long time. When this key is turned on, the lamp above the key is lit.

9 [PENCIL] key (A 39)

You can apply image processing that is suitable for originals that are pale in color such as an original written in pencil or stamped in red seal-ink. When this key is turned on, the lamp above the key is lit.

O [CONFIDENTIAL] key (A 56)

Press this key to discard the used master. When this key is turned on, the lamp above the key is lit.

a [COARSE/FINE] key (A 39)

You can select the processing method to express the gradation of a photo. The lamp above the key is lit depending on the processing method that you selected.

b [LINE/PHOTO] key (A 38)

You can select the image processing that is suitable for the type of original. The lamp above the key is lit depending on the image processing that you selected.

Liquid Crystal Panel Displays

This section describes typical screen displays.

Master making basic screen

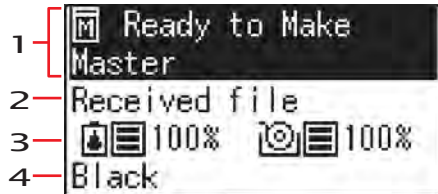

1 Message area

You can check the description of the operation and the status of this machine.

Display	Print position
	Printing mode
	Quick master making (A 62)
	Paper memory print ((A 79)

2 Original data display

When this machine receives the original data from the computer or USB flash drive, [Received file] is displayed.

The display remains blank when this machine does not receive any original data.

3 Information about consumables

You can check the remaining amount of ink or master roll.

: Remaining amount of ink

: Remaining amount of master roll

B If the remaining amount is 10% or less, the remaining amount icon () blinks.

B If information cannot be acquired from the ink bottle or master role, the remaining amount is not displayed, and the consumables icon () blinks.

4 Ink color

You can check the ink color of the print drum (cylinder) that is set in this machine.

B If information cannot be acquired from the ink bottle, [Black] or [Color] is displayed, and the icon blinks.

Print basic screen



1 Print position (horizontal direction)

You can check whether the print position (A 48) is moved toward the top or bottom of the printed paper.

Display	Print position
	Moved to the bottom
	Standard position
	Moved to the top

2 D-Feed Check display

This machine is equipped with the [D-Feed Check] function, which automatically stops printing when the feeding of overlapped sheets of paper (double feeding) is detected.

When [36: D-Feed Check] (A 64) of [Custom Setting Mode] is set to [1:ON], the icon () is displayed. (This icon is only displayed on the currently stopped basic screen for printing. It is not displayed during operation or on the master making basic screen.)

Printing Flow

“Master making process” and “Printing process”

This machine is a digital duplicator that uses the screen printing method. The screen printing method first forms minute holes on a master (plate), which is the base of the printing process. Then, ink is applied through these holes to transfer images onto paper.

In the screen printing method, “master making process” refers to the steps to create a master, and “printing process” refers to the steps in which the ink goes through the created master and the image is transferred onto paper. In this guide, “master making process” and “printing process” are together called “printing”.

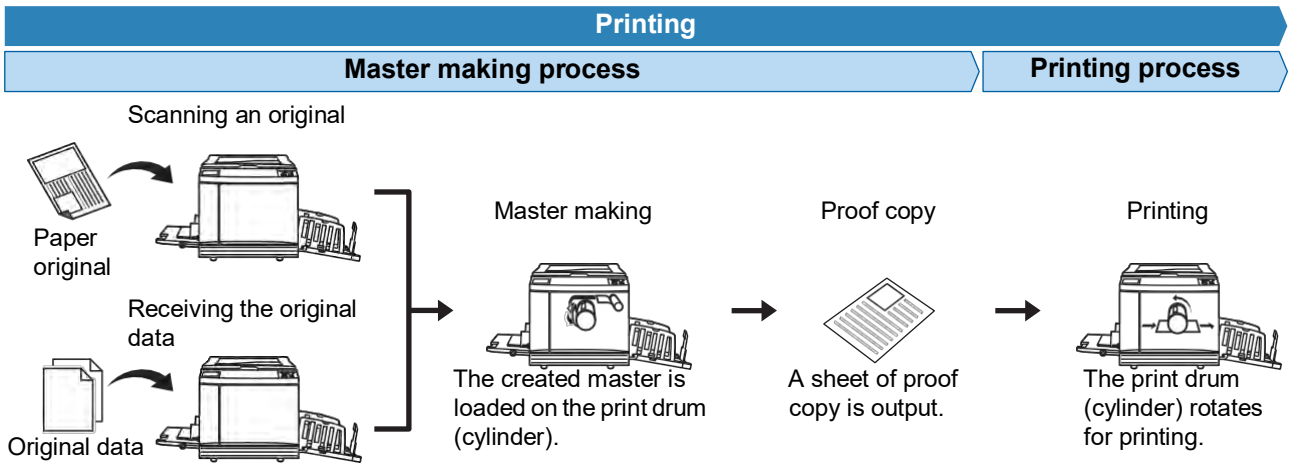

What is [Auto Process]?

[Auto Process] refers to continuous operation of the master making process and the printing process. You can turn on / off the [Auto Process] setting by pressing the [AUTO PROCESS] key (A 19).

■ When [Auto Process] is on

After the master making process, the printing process starts.

After the printing process is complete, if there is a next original on the optional auto document feeder, master making for it starts.

If the original is placed on the glass platen, the operation stops after the completion of the printing process.

Use this setting when you do not need to check the proof copy or change the printing conditions and the master making conditions.



■ When [Auto Process] is off

Operation stops after each process: master-making and printing.

Use this setting when you need to change the printing conditions after checking the proof copies or when you need to replace the paper.

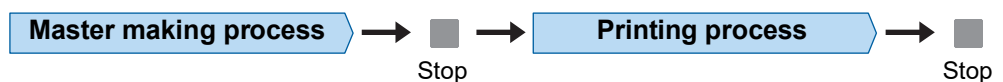



Chapter 2

Basic Operations

Preparation before Printing

Setting up the paper feed tray and the paper

1 Open the paper feed tray.

While holding the paper feed tray with your hand, open it until it stops.

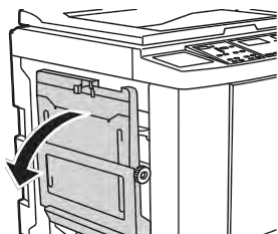

2 Place the paper on the paper feed tray.

Place the paper with the printing side facing up. Use the same orientation as that of the original. (A 28 "Placement of Originals")

- !** Do not use inappropriate paper or mix paper of different sizes. It may cause a paper jam or damage your printer. (A 12 "Printing papers")

3 Adjust the feed-tray paper guides.

Raise the lock levers on both sides of the feed-tray paper guides so that you can slide the feed-tray paper guides by hand. Tightly fit the feed-tray paper guides to the paper, and then push down the lock levers on both sides to lock the guides.

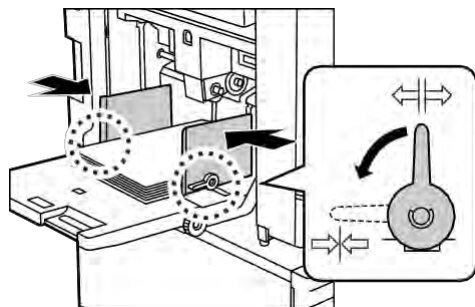

- !** This machine identifies the paper size according to the position of the feed-tray paper guides. If the feed-tray paper guides do not fit tightly to the paper, the paper size cannot be identified correctly.

4 Adjust the paper feed pressure.

Select the position of the paper-feed setting lever according to the paper type.

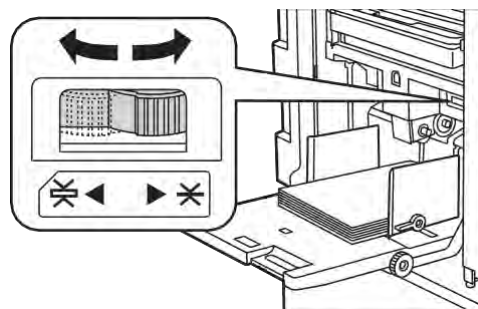

Lever	Paper type
U (NORMAL)	Newsprint paper Fine paper
Z (CARD)	Smooth cardstock Thick paper such as drawing paper

■ Adding and replacing the paper

Lower the paper feed tray to a position where you can easily remove and place paper before adding or replacing paper during the printing process. When you press and hold the feed tray ascent / descent button (A 16), the paper feed tray stops the moment you release your finger from the button.

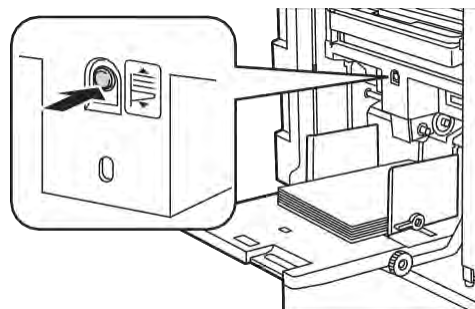

- !** After replacing the paper with that of a different type, reposition the paper-feed setting lever.
- B** After replacing the paper with that of a different size, also adjust the receiving-tray paper guides and the paper stopper.
- !** When the paper runs out or all of the paper is removed, the paper feed tray lowers to the bottom automatically.

■ How to close the paper feed tray

- 1 Remove all of the paper.**
After removing the paper, check that the paper feed tray is lowered to the bottom.

- 2 Slide the feed-tray paper guides to the ends.**

Raise the lock levers for the feed-tray paper guides and slide the feed-tray paper guides by hand.

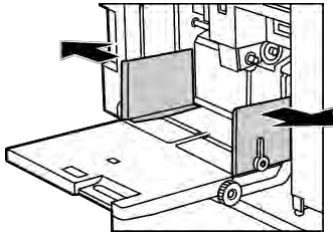

- 3 Close the paper feed tray.**

Setting up the paper receiving tray

- 1 Open the paper receiving tray.**
While holding the paper receiving tray with your hand, open it until it stops.

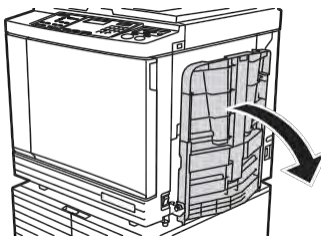

- 2 Raise the receiving-tray paper guides and the paper stopper.**

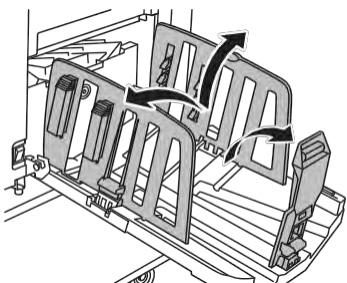

- 3 Fit the receiving-tray paper guides and the paper stopper to the paper size.**

Hold the lower parts of the receiving-tray paper guides and the paper stopper, and then slide the guides and the stopper.

Adjust each position while referring to the scale marks on the paper receiving tray.

The paper stopper stops with a click sound at each position corresponding to the standard size of a paper type.

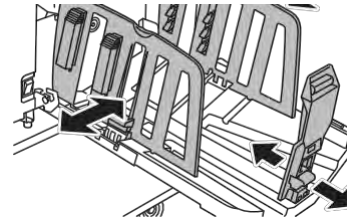

B When using thick paper, set the receiving-tray paper guides a little wider than the actual paper width.

B The optimal position of the receiving-tray paper guides varies depending on conditions such as the paper type, print speed, and operation environment. Use the scale marks on the paper receiving tray as a reference only. Adjust the position of the receiving-tray paper guides based on the actual arrangement of the printed paper.

B When adjusting the horizontal position of the paper feed tray, also adjust the position of the receiving-tray paper guides. If the positions of the paper feed tray and the receiving-tray paper guides are not aligned, a paper jam may occur.

4 Adjust the paper arrangers. (Only for SF5450EII/SF5350EII/ SF5250EII)

Adjust the paper arrangers so that printed paper is aligned.

- To open a paper arranger, press down the paper arranger knob.
- To close a paper arranger, pull up the paper arranger knob.

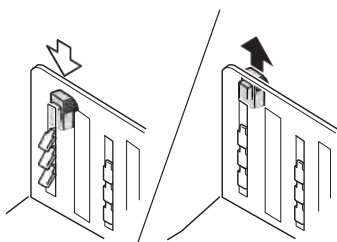

■ For normal paper

Open all four of the paper arrangers.

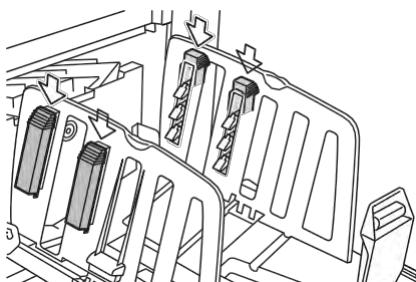

■ When a printed area is concentrated on one side of the page

Open the paper arrangers on the side with more printed ink.

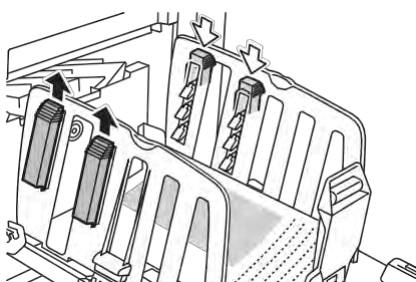

■ For thick paper

Open only the paper arrangers that are close to the machine.

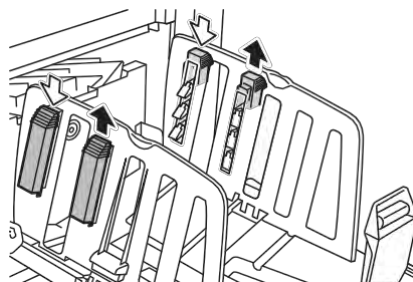

5 Adjust the paper jumping wings. (Only for SF5450EII/SF5350EII/ SF5250EII)

Turn the adjustment dial for the paper jumping wings to the position that is relevant to the paper type or size.

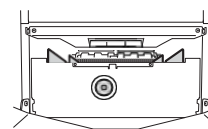

Paper type	Paper size	Dial
NORMAL	B4 or larger	
	Smaller than B4	
CARD	Any size	

6 Set the corrugators. (Only for SF5430EII/SF5330EII/ SF5230EII/SF5130EII/SF5030EII)

Lower the corrugators to the inside of the paper guides.

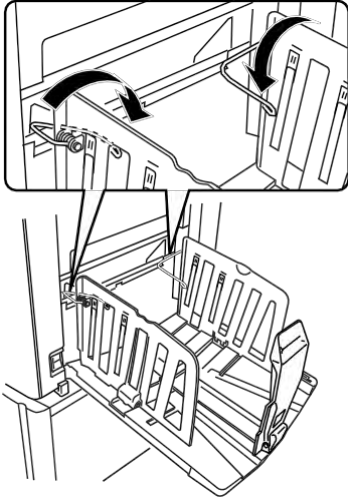

 Usually the corrugators should be lowered. When using thick paper, you do not need to lower the corrugators.

■ How to close the paper receiving tray

- 1 Remove all of the printed paper.
- 2 Slide the receiving-tray paper guides and paper stopper to the ends.

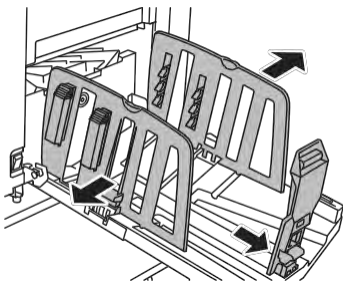

3 Close all of the paper arrangers. (Only for SF5450EII/SF5350EII/ SF5250EII)

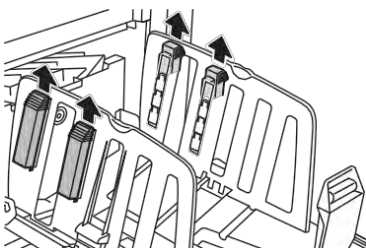

4 Raise the corrugators. (Only for SF5430EII/SF5330EII/ SF5230EII/SF5130EII/SF5030EII)

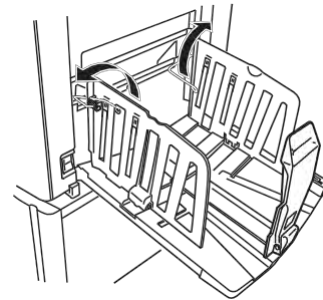

5 Fold the paper stopper inward.

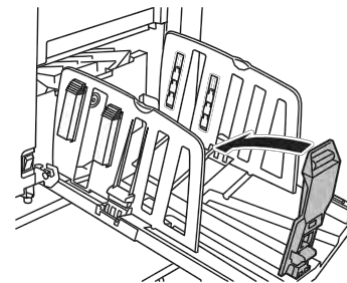

2

6 Fold the receiving-tray paper guides inward.

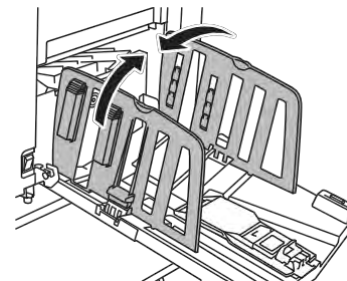

7 Close the paper receiving tray.

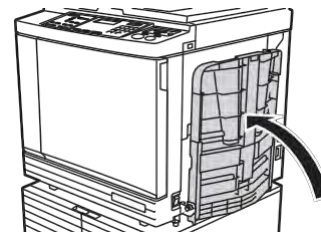

Placement of Originals

Originals can be scanned by using the glass platen or the optional auto document feeder.

Relation of original and paper orientations

Make sure that the orientations of the original and the paper are as shown below.

Short edge paper feed

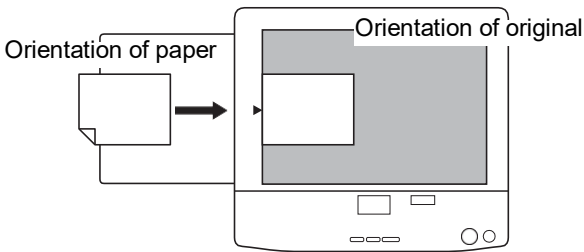

Long edge paper feed

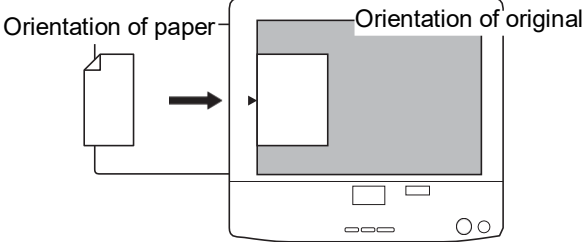

- 
B The maximum printing area varies depending on the model. (A 14 “Maximum Printing Area”) If the original is larger than the maximum printing area, reduce its size to make a master. (A 41 “Enlarging or Reducing the Size of the Original [Size]”)

- 
B When [2-UP] (A2) is set, the orientation of the original is different from the orientation of the paper.

When using the glass platen

- 1 Open the platen cover.
- 2 Place an original on the glass platen.

Place the original with the scanning side facing down and align the center of the original with the [H] mark.

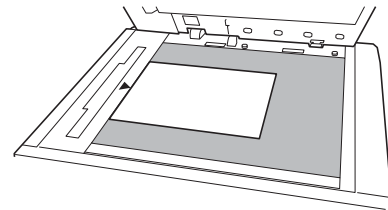



- 3 Close the platen cover.
 - 
B Close the platen cover gently. Forcefully closing the platen cover will cause damage to the glass platen or original scanning errors.

When using the auto document feeder

- 1 Place originals on the auto document feeder.

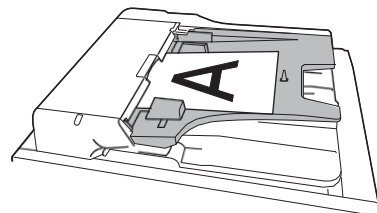
Place the originals with the scanning side facing up.



- 
B For the auto document feeder, the size and the number of originals to be placed are limited. (A 12 “Originals”)

- 2 Adjust the ADF original guides to the width of the original.

- 
B This machine identifies the original size by recognizing the positions of the ADF original guides. If the ADF original guides do not fit tightly to the original, the original size cannot be identified correctly.

Printing of Paper Originals

This section describes the procedure to scan and print paper originals.

1 Check that the power switch of this machine is on.

Press the [X] side of the power switch.



B If [ECO Mode] is displayed when you switch on this machine, [ECO

Mode] (A 64) is set.

B If the authentication screen (A 34) is displayed, perform the authentication operation.

2 Check the paper.

(A 24 “Setting up the paper feed tray and the paper”)

3 Check the paper receiving tray.

(A 25 “Setting up the paper receiving tray”)

4 Place the original.

(A 28 “Placement of Originals”)

5 Check that the master making basic screen is displayed.

If a screen other than the master making basic screen is displayed, press the [MASTER MAKING] key (A 19).

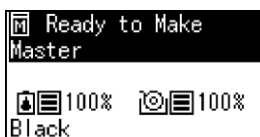

6 Check the [Auto Process] setting. (A 22 “What is [Auto Process]?”)

7 Set the master making conditions. (A 38 “Functions for Master Making”) (A 52 “Useful Functions”)

8 Enter the number of copies to be printed using the numeric keys.

9 Press the [START] key.

Master making starts and a proof copy is output.

- When the [Auto Process] setting is on, go to step 12.
- When the [Auto Process] setting is off, go to step 10.



BAn idling action (to ensure the ink usability and stability) may be automatically executed. You can change the setting in [Auto Idling Time] (A 60) under [Custom Setting Mode].

10 Set the printing conditions.

Check the printing position and density on the proof copy.

(A 46 “Functions for Printing”)



B Press the [PROOF] key to check the output using another proof copy.

B If the machine has not been used for an extended period of time, the ink on the print drum (cylinder) dries and colors in the printed output may be faint or faded. If you find the case mentioned above, output several proof copies to ensure the usability and stability of the ink. You can output proof copies consecutively by continuously pressing the [PROOF] key.

11 Press the [START] key.

The printing process starts.



B To stop the printing process, press the [STOP] key.

12 Remove the printed copies.

Fold the receiving-tray paper guides outward so the printed paper can be removed easily.

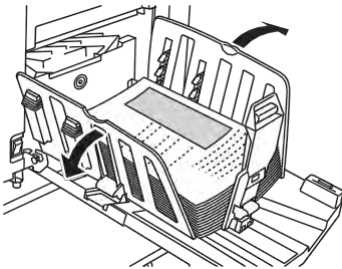

B To print more copies, enter the number of copies and press the [START] key.

B To start master making for the next original, repeat the procedure from step 4.

B When you place originals on the optional auto document feeder and the [ADF Semi-Auto] setting (A 61) is turned on, master making for the next original starts automatically. Repeat the procedure from step 10 for each original.

B To cancel the authentication status, press the [WAKE-UP] key. The authentication status is also cancelled when the time that is set in [Auto Sleep Setting] (A 60) or [Auto Clear Time] (A 60) elapses. (A 35 “Releasing the authentication status”)

Printing from Computer

You can print the original data that was created using a computer on this machine.

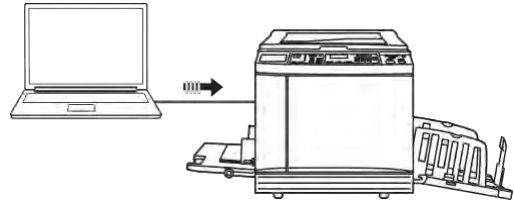

B Before printing, it is necessary to install the printer driver dedicated for this machine in the computer.

1 Turn on the power to this machine.

Press the [X] side of the power switch.



B If [ECO Mode] is displayed when you switch on this machine, [ECO Mode] (A 64) is set.

B If the authentication screen (A 34) is displayed, perform the authentication operation.

2 Check the paper.

(A 24 “Setting up the paper feed tray and the paper”)

3 Check the paper receiving tray.

(A 25 “Setting up the paper receiving tray”)

4 Turn on [INTERFACE].

If the [INTERFACE] lamp is off, press the [INTERFACE] key to light up.



- !** Note that if you press the [INTER-FACE] key while the [INTERFACE] lamp is blinking, the original data that is being received or was already received is erased.

5 Set the printing conditions in the [Print] dialog box on the computer.

Select the name of your printer under [Select Printer], and then enter the number of copies in the [Number of copies] field.

■ Example of the [Print] dialog box

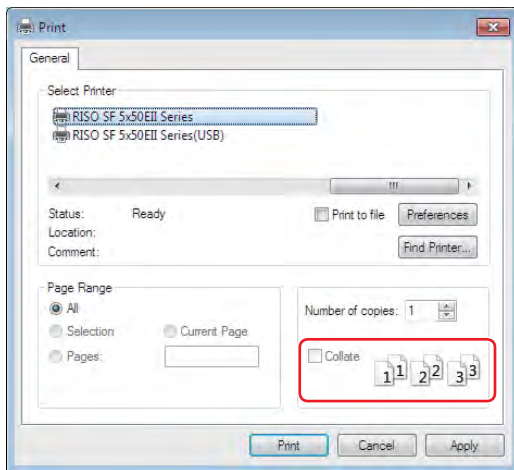

- !** Clear the [Collate] check box. If this check box is selected, master making is repeated each time a single copy is printed.

6 Perform the required settings in the [Printer Setup] ¹ screen.

Click [Preferences] ¹ in the [Print] dialog box, and then perform the following settings.

¹ The screen name and button name may vary depending on the application software that you use.

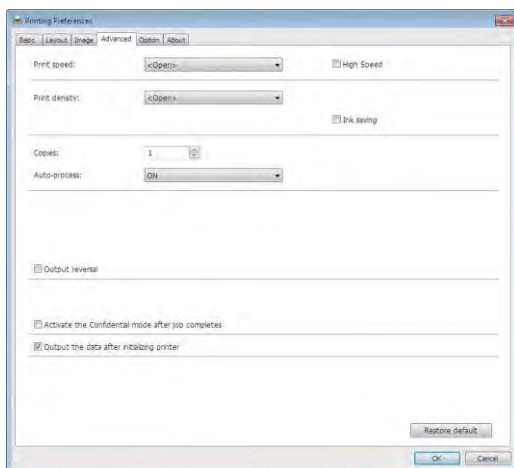

■ [Advanced] tab screen

[Auto Process]: Before master making and the printing process, you can temporarily stop the operation to check the proof copy, perform various settings, replace the paper, or do other necessary work.

■ Other printing settings

For more information, see the “RISO Printer Driver User’s Guide” (DVD-ROM).

7 Click [OK].

The [Print] dialog box is displayed.

8 Click [Print]. ²

The original data is printed according to the printer driver settings.

² The button name may vary depending on the application software that you use.

- When [Auto Process] is [ON]:
Master making is followed by the printing process.
- When [Auto Process] is set to other than [ON]:
Perform the necessary operation according to the settings.
(A 31 “When [Auto Process] is set to other than [ON]”)



B An idling action (to ensure the ink usability and stability) may be automatically executed. You can change the setting in [Auto Idling Time] (A 60) under [Custom Setting Mode].

When [Auto Process] is set to other than [ON]

The operation varies depending on the [Auto Process] setting that is selected in the printer driver.

■ When [Pause before “Master-making”] is selected

The operation pauses before master making of each page. After master making, the printing process is performed automatically.

1 Check that “Received file” is displayed in the master making basic screen.

If a screen other than the master making basic screen is displayed, press the [MASTER MAKING] key (A 19).

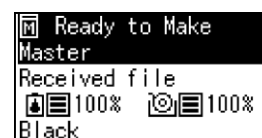

2 Press the [START] key.

After master making, the printing process starts. Operation does not pause after a proof copy has been output.

After the printing process is complete, the operation pauses and then master making of the next page starts. Repeat steps 1 to 2 for each page.

■ When [Pause before "Print"] is selected

After master making of each page is performed automatically, a proof copy is output, and then the operation pauses.

1 Check the printing conditions.

Check the printing position and density on the proof copy. Perform the required settings as necessary.

2 Press the [START] key.

The printing process starts. After the printing process is complete, master making of the next page starts. After outputting a proof copy, the operation pauses. Repeat steps 1 to 2 for each page.

■ When [OFF] is selected

Before the master making process and before the printing process of each page, the operation pauses.

1 Check that "Received file" is displayed in the master making basic screen.

If a screen other than the master making basic screen is displayed, press the [MASTER MAKING] key (A 19).

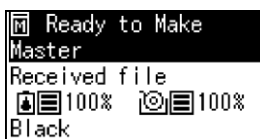
**2 Press the [START] key.**

Master making starts. After master making is complete, a proof copy is output and then the operation pauses.

3 Check the printing conditions.

Check the printing position and density on the proof copy. Perform the required settings as necessary.

4 Press the [START] key.

The printing process starts. After the printing process is complete, the operation pauses and then master making of the next page starts. Repeat steps 1 to 4 for each page.

Printing by Using the USB Flash Drive

By using the printer driver, you can print the original data that is saved in a USB flash drive with this machine.

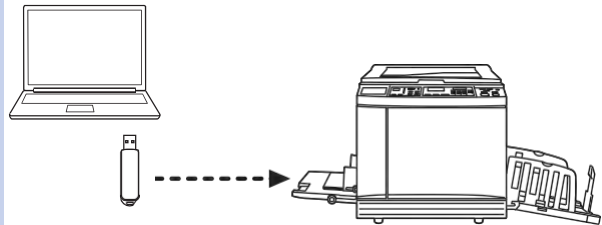

BBefore printing, it is necessary to install the printer driver that is dedicated for the USB flash drive in the computer.

BYou cannot print any original data (PDF file, etc.) that is saved in a method other than steps 1 to 6 below.

1 Connect the USB flash drive to the computer.**2 Set the printing conditions in the [Print] dialog box on the computer.**

In [Select Printer], select the printer driver that is dedicated for the USB flash drive. ("(USB)" is added to the name of your printer.)

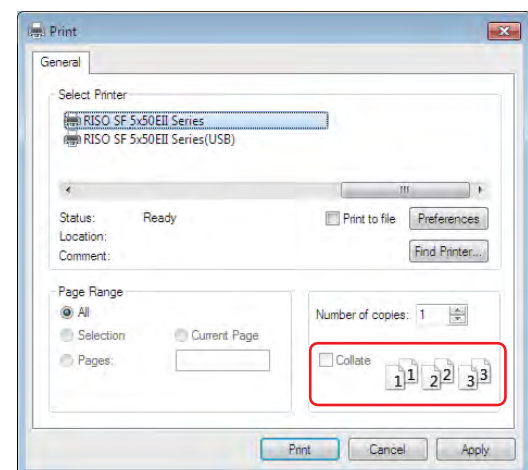
■ Example of the [Print] dialog box

BClear the [Collate] check box. If this check box is selected, master making is repeated each time a single copy is printed.

3 Perform the required settings in the [Printer Setup] ¹ screen.

Click [Preferences] ¹ in the [Print] dialog box, and then perform the following settings.

¹ The screen name and button name may vary depending on the application software that you use.

■ [Advanced] tab screen

[Auto Process]: Before master making and the printing process, you can temporarily stop the operation to check the proof copy, perform various settings, replace the paper, or do other necessary work.

■ Other printing settings

For more information, see the “RISO Printer Driver User’s Guide” (DVD-ROM).

4 Click [OK].

The [Print] dialog box is displayed.

5 Click [Print]. ²

² The button name may vary depending on the application software that you use.

6 Remove the USB flash drive.

While this computer is saving the original data, a printer icon is displayed on the Windows taskbar.

After the printer icon on the taskbar goes off, remove the USB flash drive from the computer.

! Do not remove the USB flash drive during the saving process. It may cause data loss or damage the USB flash drive.

B It may take several minutes until the processing is completed.

7 Turn on the power to this machine.

Press the [X] side of the power switch.

B If [ECO Mode] is displayed when you switch on this machine, [ECO Mode] (A 64) is set.

B If the authentication screen (A 35) is displayed, perform the authentication operation.

8 Check the paper.

(A 24 “Setting up the paper feed tray and the paper”)

9 Check the paper receiving tray.

(A 25 “Setting up the paper receiving tray”)

10 Turn on [INTERFACE].

If the [INTERFACE] lamp is off, press the [INTERFACE] key to light up.

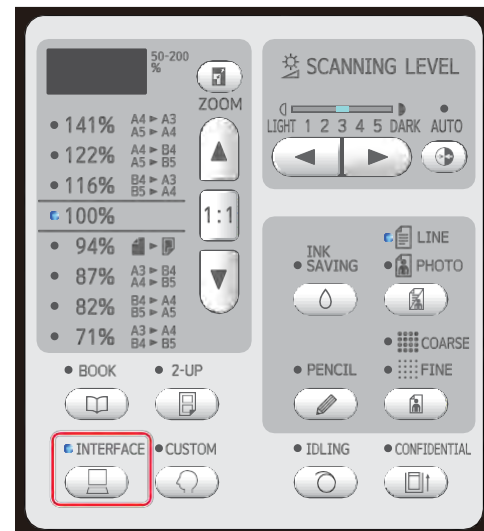

11 Insert the USB flash drive that contains the original data into the USB port.

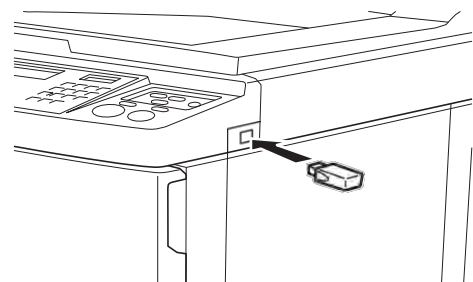

- When [Auto Process] is [ON]: Master making is followed by the printing process.
- When [Auto Process] is set to other than [ON]: Perform the necessary operation according to the settings. (A 31 “When [Auto Process] is set to other than [ON]”)



B While this machine is processing the original data, [USB Accessing...] is displayed on the screen. Do not remove the USB flash drive while this message is displayed. It may cause data loss or damage the USB flash drive.

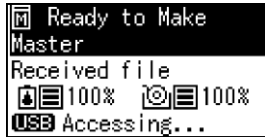

B Original data in the USB flash drive will be erased automatically after master making.

12 Remove the USB flash drive.

Check that [USB Accessing...] is not displayed, and then remove the USB flash drive.

Performing authentication before using this machine

"Authentication" refers to identifying this machine's users using the PIN code assigned to each user. Identifying users enhances the management capability and security level for each user.

Performing authentication operation

If the following authentication screen is displayed, it indicates that [Authentication Setting] (A 70) of [Custom Setting Mode] has been set to [ON].

In this case, you will need to perform the authentication operation in order to use this machine.

The following two methods are available to perform the authentication operation.

The method to use is specified in [Authentication Method] (A 70) of [Custom Setting Mode].

■ Entering the PIN code



1 Enter the PIN code using the numeric keys.

The entered code digits are displayed as "j".

2 Press the [START] key.

When the authentication screen disappears, this machine can be used.



B If an incorrect PIN code is entered, the buzzer sounds. Enter the correct PIN code.

B You can select [Custom Setting Mode] - [User Registration] to confirm or change the PIN code (A 70).

B If a user set to [Disable] (A 71) performs the authentication operation, the buzzer sounds, and an error number (F39) is displayed.

■ Using the IC card reader (option)

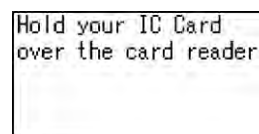

1 Touch the IC card reader with the registered IC card.

When the authentication screen disappears, this machine can be used.

Remove the IC card from the IC card reader. The authentication status remains even after the IC card is removed from the IC card reader.



B If the IC card cannot be read correctly, the buzzer sounds. Touch again

B You will need to register the IC card for authentication purposes on this machine in advance (A 70 "[User Registration]")

B If a user set to [Disable] (A 71) performs the authentication operation, the buzzer sounds, and an error number (F39) is displayed. Pressing the [RESET] key resets the error.

Releasing the authentication status

The status in which this machine has identified the user after the authentication operation succeeds is referred to as "authentication status".

After using this machine, release the authentication status.



B If the authentication status is not released, this machine will become available to other users.

1 Press the [WAKE-UP] key that is lit.



In the authentication status, the [WAKE-UP] key (A 19) is lit even when the machine is not in sleep mode. If you press the [WAKE-UP] key in this status, authentication is released.



B The authentication status is automatically released after the specified time in [Auto Clear time] (A 60) or [Auto Sleep Setting] (A 60) has elapsed.



Chapter **3**

3

Functions for Master Making

Functions for Master Making

For the details and setting procedure of each function, see the pages that are specified as a reference.

■ Functions related to image processing

[LINE/PHOTO] [PENCIL] (A 38)

You can set the processing that is suitable for the type of original.



[Dot Process] (A 39)

You can set the processing method to express the gradation of a photo.

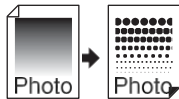

[SCANNING LEVEL] (A 40)

You can adjust the scanning level according to the paper color and the tint of the original.

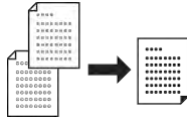

[BOOK] (A 40)

You can erase the shadow in the binding section of books.

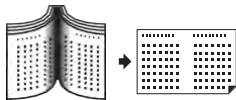

[INK SAVING] (A 41)

You can reduce the amount of ink consumption.



■ Functions related to layout

[Size] (A 41)

You can enlarge or reduce the size of the original.

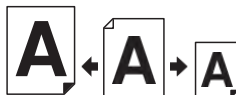

[2-UP] (A 42)

You can lay out two copies of originals side by side on a single sheet of paper.

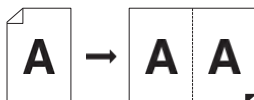

Image Processing That Is Suitable for the Original [LINE/PHOTO] [PENCIL]

You can obtain clearer images by selecting processing that is suitable for the type of original. Set either [LINE/PHOTO] or [PENCIL].



BYou can change the default setting in [Original Scanning Mode Default Setting] (A 59) under [Custom Setting Mode].

[LINE/PHOTO]

Select the processing that is suitable for the ratio of characters and photos that are included in the original.

1 Press the [LINE/PHOTO] key.

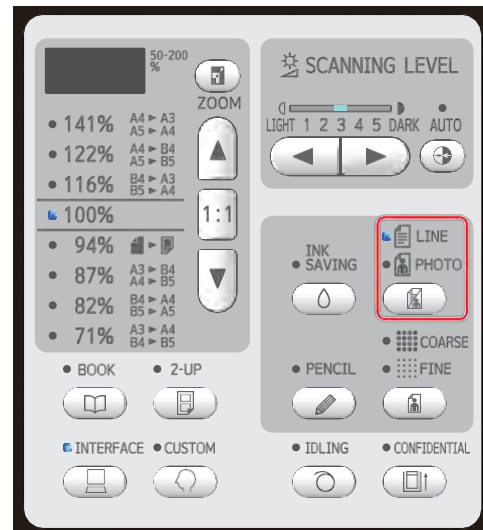

Each press of the [LINE/PHOTO] key changes the setting.

■ [cLINE]

Select this function for originals that do not contain photos. It is suitable for clearly expressing characters, or pictures with unvarying tint.



BYou cannot use this function with [Dot Process] (A 39).

■ [dPHOTO]

Select this function when clearness of photos is important.



BYou cannot use this function with [AUTO] under [SCANNING LEVEL] (A 40).

BYou can change the processing method to express the gradation of a photo in [Dot Process] (A 39).

■ [eDUO]

Both [LINE] and [PHOTO] light up.
Select this function when you want clearness of both characters and photos.



- B You can change the image quality in [Duo Mode Setting] (A 63) under [Custom Setting Mode].
- B You cannot use this function with [AUTO] under [SCANNING LEVEL] (A 40).
- B You can change the processing method to express the gradation of a photo in [Dot Process] (A 39).

[PENCIL]

Select this function for originals that are pale in color such as an original written in pencil or stamped in red seal-ink.



- B You can change the image quality in [Pencil Mode Setting] under [Custom Setting Mode] (A 63).
- B You cannot use this function with the following functions.
C [Dot Process] (A 39)
C [AUTO] under [SCANNING LEVEL] (A 40)

1 Press the [PENCIL] key.

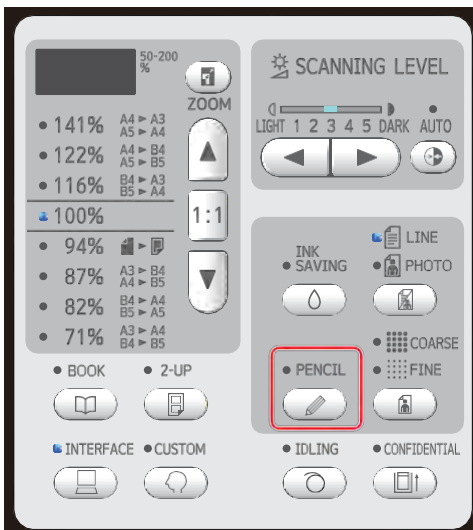

Press the [LINE/PHOTO] key to turn off [PENCIL].

Selecting a Method to Process the Gradation of Photos [Dot Process]

You can set the processing method to express the gradation of a photo.



- B [Dot Process] can be selected only when [PHOTO] or [DUO] has been set for [LINE/PHOTO] (A 38).

1 Press the [COARSE/FINE] key.

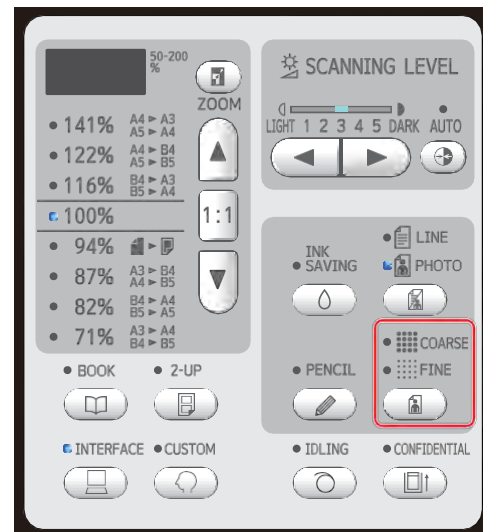

Each press of the [COARSE/FINE] key changes the setting.

■ [OFF]

Gradation of photos is processed by an error diffusion method.

The gradation is expressed by changing the density of dots that are irregularly arranged.

■ [eCOARSE] / [fFINE]

Gradation of photos is processed by a dot process method.

The gradation is expressed by changing the size of dots that are regularly arranged.

[e COARSE]: Equivalent to 53 lines

[f FINE]: Equivalent to 106 lines

Adjusting the Scanning Level of the Original [SCANNING LEVEL]

You can adjust the contrast according to the conditions such as the paper color and the tint of the original.



You can change the default setting in [Scanning Level] (A 59) under [Custom Setting Mode].

You cannot change the [SCANNING LEVEL] setting when [INK SAVING] (A 41) is turned on.

1 Press the scanning level adjustment keys.

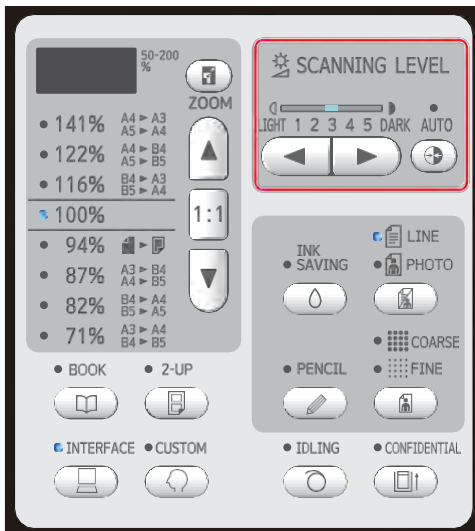

- Each press of the [AUTO] key turns on / off the [AUTO] setting.
- Each press of the [◀] key decreases the scanning density by one level.
- Each press of the [▶] key increases the scanning density by one level.

■ [AUTO]

You can select this button only when [LINE] is selected in [LINE/PHOTO] (A 38). When you select [AUTO], the scanning level is adjusted optimally according to the paper color of the original.

■ [1] to [5]

You can adjust the scanning density in five levels.

Select [1] for the lowest density.
Select [5] for the highest density.

Using a Book Type Original [BOOK]

When you scan an original that is bound at the center, such as a book, you can erase the shadow of the binding section.



Be sure to align the original to the center along the left side of the glass platen and place the original in the direction shown below.

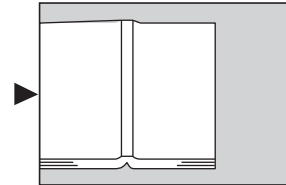

When scanning a thick book, raise the hinges of the platen cover so that you can press the book evenly using the cover.

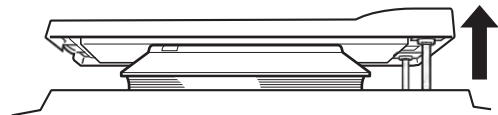

In [Original Book Size] (A 59) under [Custom Setting Mode], you can change the size of the original that is to be scanned.

In [Book Gutter Shadow Width] (A 59) under [Custom Setting Mode], you can change the range that is to be erased.

You cannot use this function with the following functions.

- C[2-UP] (A 42)
- C[Quick Master Making] (A 62)

1 Press the [BOOK] key.

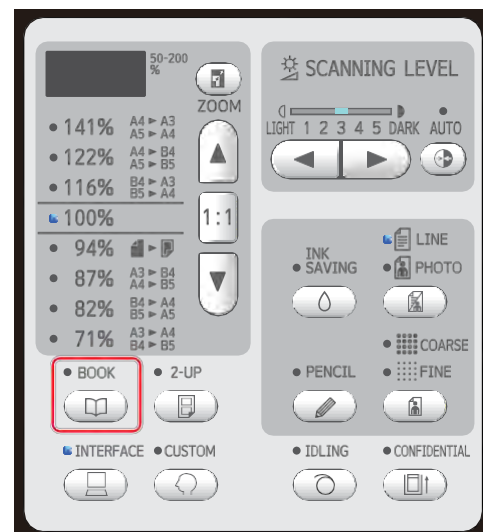

Saving Ink [INK SAVING]

By turning on [INK SAVING] when making a master, you can reduce the amount of ink consumption during printing.

- ❗ **When [INK SAVING] is turned on, the print density becomes lower.**
- 📌 **Even if you change the [INK SAVING] setting during the printing process, the new setting is not applied to the master that has already been made and loaded on the print drum (cylinder). The changed [INK SAVING] setting is used for the next master making.**

- 📌 **When [INK SAVING] is on, the settings of the following functions cannot be changed.**
 - C[SCANNING LEVEL] (A 40)
 - C[Print Density] (A 47)

1 Press the [INK SAVING] key.

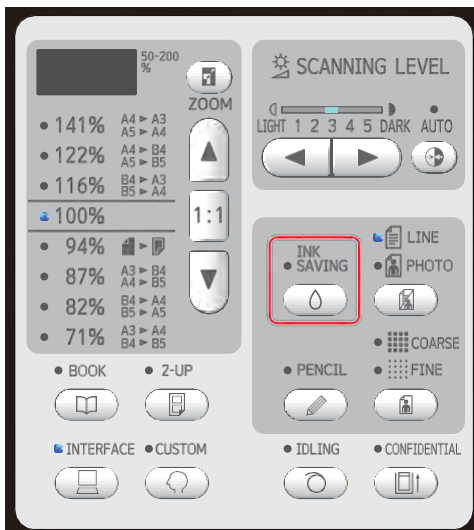

Enlarging or Reducing the Size of the Original [Size]

You can scan an original so that it is enlarged or reduced in size.

- ❗ **Image parts outside the range for master making are not printed.** (A 14 “Master making area”)
- 📌 **When the magnification rate is set to a rate other than [100%], [Quick Master Making] (A 62) is disabled.**

The size setting method can be selected from the following two options.

- [Standard ratio]: You can set the size of the original simply by selecting a magnification rate.
- [Zoom]: You can set the magnification rate.

[Standard ratio]

1 Select the magnification rate.

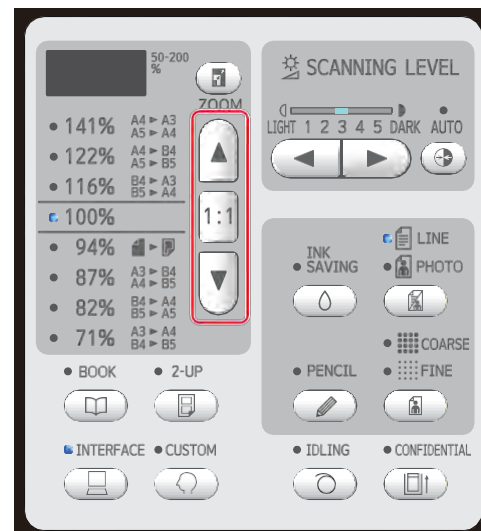

- Pressing the [▲] or [▼] key lights up the lamp of the magnification rate you selected.
- Pressing the [1:1] key returns the magnification rate to 100%.

- 📌 **The standard ratios differ among the models. Check the panel on your machine.**

[Zoom]

1 Press the [ZOOM] key.

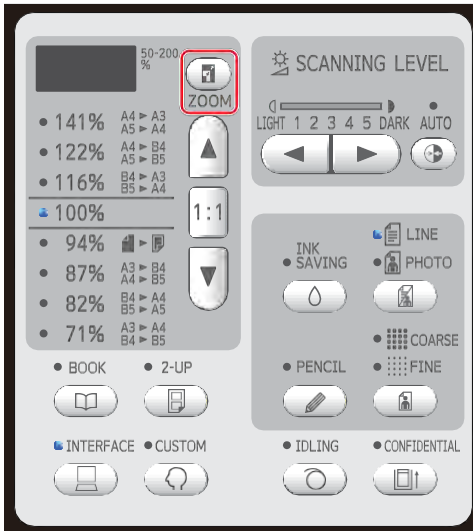

The magnification rate is displayed to the left of the [ZOOM] key.

2 Specify the magnification rate.

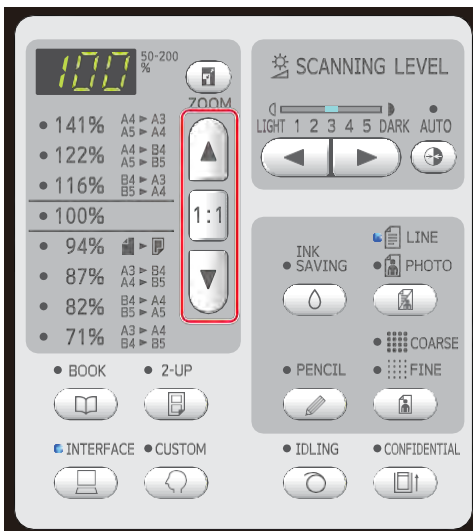

- Pressing the [▲] key increases the magnification rate by 1%.
- Pressing the [▼] key decreases the magnification rate by 1%.
- Pressing the [1:1] key returns the magnification rate to 100%.

Laying Out Two Copies of Originals on a Single Sheet of Paper [2-UP]

The process for laying out two copies of originals on a single sheet of paper is referred to as “2-UP”.



BYou cannot use this function with the following functions.

- C[BOOK] (A 40)
- C[Quick Master Making] (A 62)

■ Final images

2-up with one original:

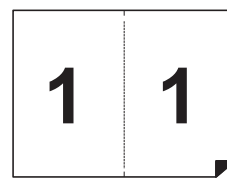

2-up with two originals:



1 Placement of Originals

Place an original in the direction shown below.



BWhen placing an original on the glass platen and performing “2-UP with one original”, you can set [2-Up Mode Scan Waiting Time] (A 60) to [None] in [Custom Setting Mode] to perform 2-UP simply by pressing the [START] key once. When performing “2-UP with two originals”, set [2-Up Mode Scan Waiting Time] to [15s] or [30s] because waiting time is necessary to place the second original. (The factory default is [15s].)

BWhen performing “2-UP with two originals” with the optional auto document feeder, place both originals if you do not need to change settings for the second original. If you want to change settings for the second original, place the originals one at a time.

2 Place the paper.

Place the paper in the direction of a short edge paper feed.

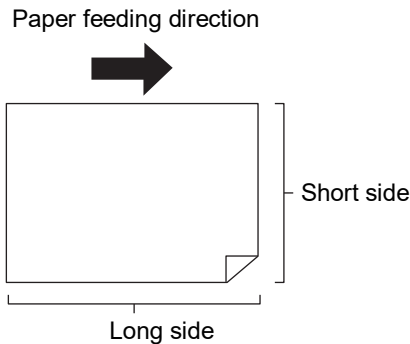

3 Set the paper receiving tray.

(A 25 "Setting up the paper receiving tray")

4 Check that the master making basic screen is displayed.

If a screen other than the master making basic screen is displayed, press the [MASTER MAKING] key (A 19).

5 Press the [2-UP] key.

6 Set the other required master making conditions.

(A 38 "Functions for Master Making")
(A 52 "Useful Functions")



B The reduction and enlargement rates are different from the standard magnification rates. Specify a magnification rate that is shown in the table below.

		Original			
		A4	B5	A5	B6
Printing Paper	A3	100%	116%	141%	163%
	B4	87%	100%	122%	141%
	A4	71%	82%	100%	116%
	B5	61%	71%	87%	100%

		Original			
		A6	B7	A7	B8
Printing Paper	A3	200%	---	---	---
	B4	173%	200%	---	---
	A4	138%	163%	200%	---
	B5	122%	141%	173%	200%

		Original	
		Letter	Statement
Printing Paper	Ledger	100%	127%
	Legal	77%	100%
	Letter	66%	100%
	Statement	50%	66%

7 Press the [START] key.

Scanning of the original starts. When the first scan is finished, a buzzer sounds to notify the waiting time. The next procedure is as follows.

■ If the original was placed on the glass platen

- "2-UP with one original"
Press the [START] key again.
- "2-UP with two originals"
Place the second original during the waiting time, perform various settings as necessary, and then press the [START] key again.



B If you do not press the [START] key during the waiting time, one side will be printed as a blank space.

■ If the original was placed on the optional auto document feeder

- "2-UP with one original"
Place the original on the optional auto document feeder again during the waiting time. Scanning starts automatically.
- "2-UP with two originals"
If the originals were placed on top of each other, scanning continues and master making starts automatically. When placing the originals one at a time, perform various settings during the waiting time and then place the second original. Scanning starts automatically.



B If you do not place an original during the waiting time, one side will be printed as a blank space.



Chapter 4

Functions for Printing

Functions for Printing

For the details and setting procedure of each function, see the pages that are specified as a reference.

[SPEED] (A 46)

You can adjust the print speed.

[DENSITY] (A 47)

You can adjust the print density.

[PRINT POSITION] (A 48)

You can adjust the print position.

Adjusting the Print Speed [SPEED]

You can adjust the print speed. It is possible to adjust the print speed not only before but also during the printing process.



You can change the default setting in [Print Speed] (A 59) under [Custom Setting Mode].

1 Press the [SPEED] key ([O] or [N]).

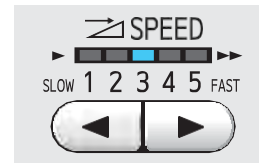

- Each press of the [O] key decreases the print speed by one level.
- Each press of the [N] key increases the print speed by one level.

The table below shows the relation between the print speed lamp status and the print speed.

Lamp	Print speed (sheets / minute)
1 2 3 4 5	Approximately 60
1 2 3 4 5	Approximately 80
1 2 3 4 5	Approximately 100
1 2 3 4 5	Approximately 120
1 2 3 4 5	Approximately 130
1 2 3 4 5	Approximately 150 ([High Speed])*

* Only for SF5450EII/SF5350EII/SF5250EII



B [High Speed] is available when the temperature in the print drum (cylinder) is 5°C (41°F) or higher. If the print drum (cylinder) is cool, increase the room temperature or print at speed [5] for a while, and wait until the print drum (cylinder) is sufficiently warm.

B Some types of paper may cause a paper jam easily. When using such paper, print at a lower speed.



B When [Slip Sheet Sorting] (A 79) of [Custom Setting Mode] is set to [ON], [High Speed] cannot be set.

Adjusting the Print Density [DENSITY]

You can adjust the print density. It is possible to adjust the print density not only before but also during the printing process.



B You can change the default setting in [Print Density] (A 59) under [Custom Setting Mode].

B You cannot change the print density when [INK SAVING] (A 41) is turned on.

1 Press the [DENSITY] key ([O] or [N]).



- Each press of the [O] key decreases the print density by one level.
- Each press of the [N] key increases the print density by one level.

The print density lamp shows the current print density level.

Adjusting the Print Position [PRINT POSITION]

You can adjust the print position. The adjustment method differs between the horizontal direction and vertical direction.

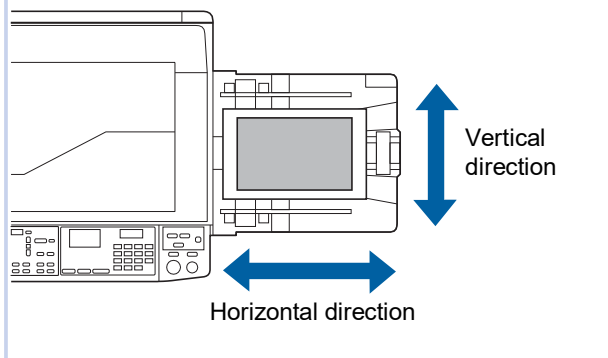

Adjusting the position in the horizontal direction

You can adjust the print position in the horizontal direction using the [PRINT POSITION] keys on the control panel. It is possible to adjust the print position not only before but also during the printing process.

1 Press the [PRINT POSITION] key ([O] or [N]).

Each press of the [O] or [N] key moves the printed image by 0.5 mm (1/64 inches).

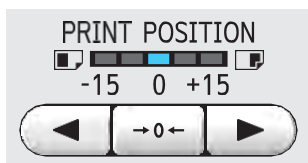

B Press the [P] key to return the printed image to the standard position.

B After the adjustment, press the [PROOF] key to check the printed paper.

! If the following operations are performed, the print position in the horizontal direction is returned to the standard position.
C Press the [RESET] key.
C Turn off the power.

Adjusting the position in the vertical direction

You can adjust the print position using the vertical print position adjustment dial on the paper feed tray.

1 Lower the paper feed tray.

Press the feed tray ascent / descent button to lower the paper feed tray until the paper feed roller separates from the paper.

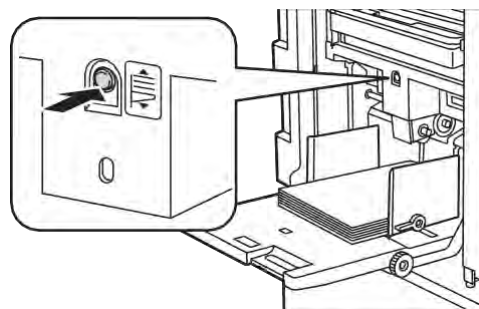

2 Turn the vertical print position adjustment dial.

Adjust the vertical print position while checking the scale for the shifted length. The [N] symbol on the scale indicates the standard print position.

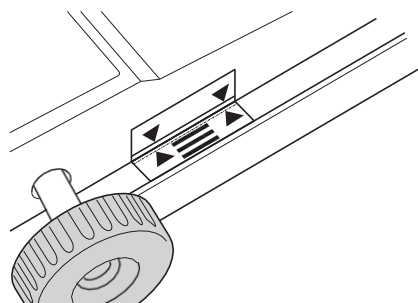

B The scale is only a reference. After the adjustment, press the [PROOF] key to check the printed paper.

■ Moving the printed image upward on the paper

Turn the dial clockwise.

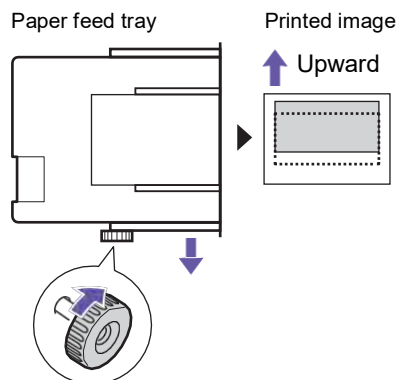

As the paper feed tray moves to the front of this machine, the printed image is shifted upward relative on the paper.

■ Moving the printed image downward on the paper

Turn the dial counterclockwise.

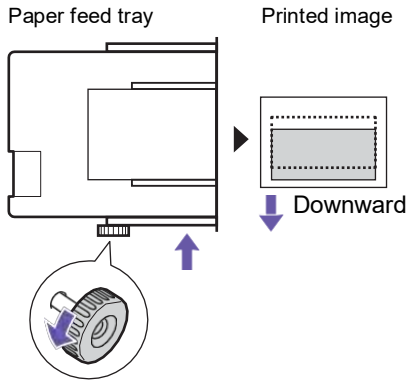

As the paper feed tray moves to the back of this machine, the printed image is shifted downward relative on the paper.

3 Adjusting the position of the receiving-tray paper guides

Adjust the position of the receiving-tray paper guides according to the shifted length of the paper feed tray. If the positions of the paper feed tray and the receiving-tray paper guides are not aligned, a paper jam may occur.

(A 25 "Setting up the paper receiving tray")

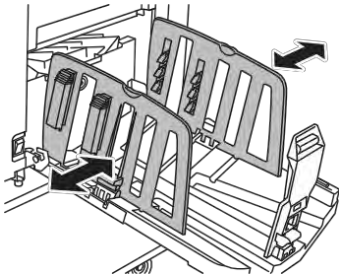

B After the printing process is complete, return the positions of the paper feed tray and the receiving-tray paper guides to their standard positions. To return the paper feed tray to the standard position, turn the dial until the edge of the paper feed tray aligns with the [M] symbol on the scale.

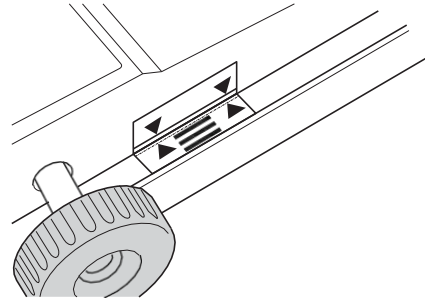



Chapter 5

Useful Functions

Useful Functions

For the details and setting procedure of each function, see the pages that are specified as a reference.

[Program] (A 52)

You can separate and sort the printed paper by a specified number of sheets.

[IDLING] (A 56)

When the print drum (cylinder) has not been used for a long time, you can reduce blurring of ink at the beginning of printing.

[CONFIDENTIAL] (A 56)

You can discard the master that has already been used.

Printing the Sorted Originals [Program]

You can separate the number of copies to be printed for each set or each original. As the printing process stops for a few seconds after printing the specified number of copies (for each set or each original), you can sort the printed paper. This function is useful for when the required number of copies to distribute varies for each department or class.



BThis function is useful when it is used with [Slip Sheet Sorting] (A 79) because printed paper is sorted according to each specified separation with a slip sheet.

BThis function is useful when it is used with [Job Separation] (A 62) because printed paper is sorted according to each specified separation with a tape.

The optional Job Separator is required to use [Job Separation].

■ Types of [Program]

[Single Page Mode]:

You can set the number of copies to be printed from a single original for each “set”.

The “sets” can be organized into a “group”.

It is possible to set up to 9999 copies × 99 sets × 50 groups.

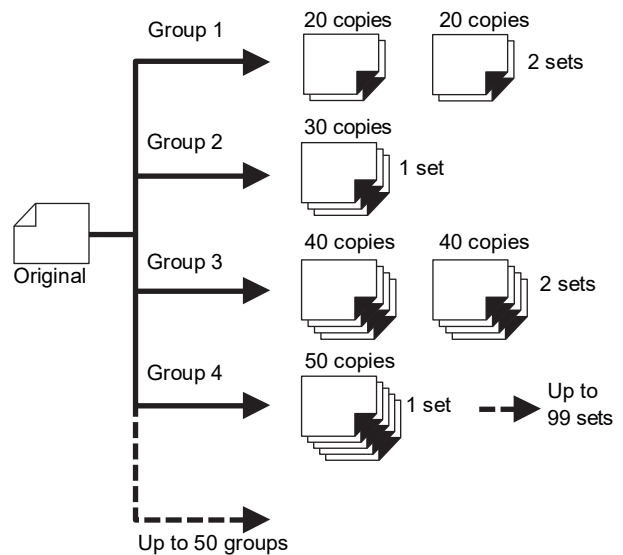

[Multi-Page Mode]:

You can set different numbers of copies for multiple originals.

It is possible to set up to 9999 copies × 20 originals.

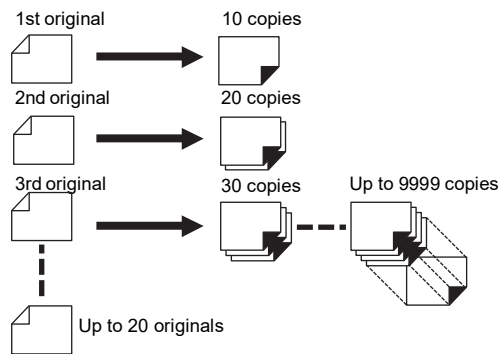
**■ How to use [Program]**

There are the following two methods.

- For printing without registering program settings

(A 53 “Setting [Single Page Mode]”)

(A 53 “Setting [Multi-Page Mode]”)

- For printing by retrieving a registered [Program] setting
 (A 54 “Retrieving [Program]”)

Setting [Single Page Mode]**1 Press the [P] key.**

The [Single Page Mode] screen is displayed.



B Each press of the [P] key switches the screen between [Single Page Mode], [Multi-Page Mode], and [Program OFF].

2 Press the [+] key.**3 Enter a value in [Cps.].**

Enter the number of prints for the first group using the numeric keys.

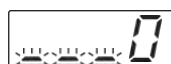
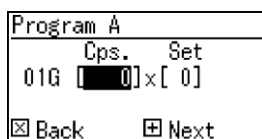
**4 Press the [+] key.****5 Enter a value in [Set].**

Enter the number of sets for the first group using the numeric keys.

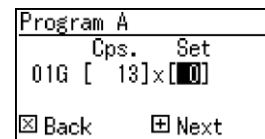
6 Press the [+] key.

Then, perform settings for the next group.
 Repeat steps 3 to 6 as necessary.



B If you want to register the settings of [Program], go to step 2 in “Registering [Program]” (A 54).

7 Print.

The rest of the procedure is the same as the normal printing operation of paper originals.
 (A 29 “Printing of Paper Originals”)



B Printing is performed in the reverse order of registration from the last group. (Example: [03G] -> [02G] -> [01G])
 In this case, [01G] is output on the top of the printed paper in the paper receiving tray.

Setting [Multi-Page Mode]**1 Press the [P] key twice.**

The [Multi-Page Mode] screen is displayed.



B Each press of the [P] key switches the screen between [Single Page Mode], [Multi-Page Mode], and [Program OFF].

2 Press the [+] key.**3 Enter a value in [Cps.].**

Enter the number of prints for the first original using the numeric keys.

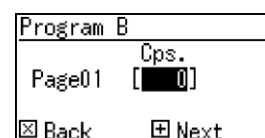

4 Press the [+] key.
 Then, perform settings for the next original.
 Repeat steps 3 and 4 as necessary.

! If you want to register the settings of [Program], go to step 2 in “Registering [Program]” (A 54).

5 Print.
 The rest of the procedure is the same as the normal printing operation of paper originals. (A 29 “Printing of Paper Originals”)

! Printing is performed in the reverse order of registration from the last original. (Example: [Page 03] -> [Page 02] -> [Page 01])
 In this case, [Page 01] is output on the top of the printed paper in the paper receiving tray.

Canceling [Program]

1 Press the [P] key.
 The [P] key lamp goes off and [Program] is turned off.

! Each press of the [P] key switches the screen between [Single Page Mode], [Multi-Page Mode], and [Program OFF].

Registering [Program]

It is useful if you register a program that is used frequently.
 You can register a total of 6 [Single Page Mode] and [Multi-Page Mode] programs.

1 Set a program.
 Perform either of the following settings.

- Steps 1 to 6 in “Setting [Single Page Mode]” (A 53).
- Steps 1 to 4 in “Setting [Multi-Page Mode]” (A 53).

2 Press the [U] key.

3 Enter the program number.
 Enter the program number that you want to register using the numeric keys.

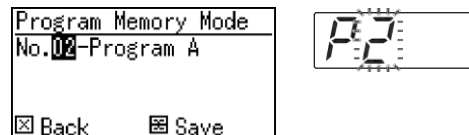

- If you enter a program number that is already registered, either [a] (Single Page Mode) or [b] (Multi-Page Mode) is displayed in the numeric display.
- If you enter a program number that is not registered, neither [a] nor [b] is displayed.

! If you enter a program number that is already registered, the setting is overwritten. Check to make sure there is no problem if the settings are overwritten.

4 Press the [U] key.
 The settings of [Program] are registered. The number and type of the registered programs (either [a] or [b]) are displayed in the numeric display.

- When you press the [START] key, printing can be performed according to the [Program] settings that you registered.
- Pressing the [P] key turns off [Program].

Retrieving [Program]

1 Press the [P] key.
 The [P] key lamp lights up.

2 Press the [U] key.

3 Enter the program number.
 Enter the program number that you want to retrieve using the numeric keys.

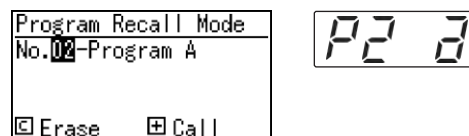

4 Press the [+] key.
 The settings that you registered are retrieved.

- When you press the [START] key, printing can be performed according to the [Program] settings that you retrieved.
- Pressing the [P] key turns off [Program].

6 Press the [P] key.

[Program] is turned off.

Changing the settings of [Program]

- 1 Retrieve a program.**
Perform steps 1 to 4 in “Retrieving [Program]”.
- 2 Press the [+] key.**
You can now change the settings.
- 3 Change the settings of the program.**
Change the number of copies and the number of sets.
 - Pressing the [C] key clears the values that were set, and you can input a new entry using the numeric keys.
 - Pressing the [+] key goes to the next input target.
 - Pressing the [x] key goes back to the previous input target.
- 4 Press the [U] key.**
For the rest of the procedure, register the changes by performing steps 3 and 4 in “Registering [Program]”.

Erasing [Program]

- 1 Press the [P] key.**
The [P] key lamp lights up.
 - 2 Press the [U] key.**
 - 3 Enter the program number.**
Using the numeric keys, enter the program number that you want to erase.
- Program Recall Mode
No. 02-Program A
[Erase] [Call]
- P2 2
- 4 Press the [C] key.**
 - 5 Press the [START] key.**
[Program] that you specified is erased.

Preventing Blurring of Ink [IDLING]

When this machine has not been used for a long time or after the print drum (cylinder) has been replaced, several sheets of printing may be faded at the beginning of printing. When you turn on [IDLING], the operation to ensure the ink usability and stability is performed during master making. As this function enables clear printing from the beginning, you can save paper.

! B[IDLING] is a function that is performed during master making. If you perform the printing process only, [IDLING] is not performed.

BWhen [IDLING] is performed, the time required for master making becomes longer.

 BYou can set [IDLING] to be performed automatically during the next master making if the print drum (cylinder) has not been used for a long time. You can change the setting in [Auto Idling Time] under [Custom Setting Mode] (A 60).

1 Press the [IDLING] key.

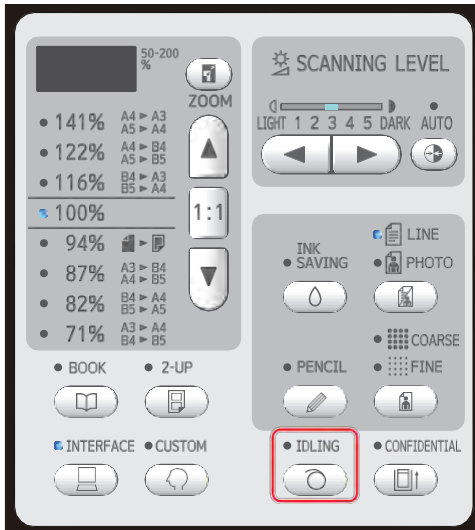

When you place an original and press the [START] key while the [IDLING] lamp is lit, [IDLING] is performed during master making.

Preventing Copying of Confidential Documents [CONFIDENTIAL]

After printing, the master that has been made is still loaded on the print drum (cylinder) in the print ready status.

When [CONFIDENTIAL] is turned on, the master that has been made is discarded. Therefore, you can prevent improper printing of confidential documents.

As a blank master is loaded on the print drum (cylinder), the master also plays the role of a cover to prevent ink in the print drum (cylinder) from drying out when printing is not performed for a long time.

1 Press the [CONFIDENTIAL] key.

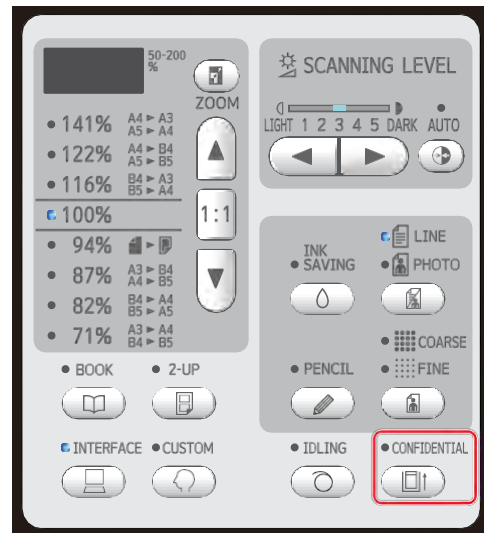

2 Press the [START] key.

The master on the print drum (cylinder) is discarded and a blank master is loaded.



Chapter 6

Setting the Operation Conditions

Setting the Operation Conditions [Custom Setting Mode]

You can change the default values and set the system control-related settings in order to make this machine more convenient for use.

Basic operation of [Custom Setting Mode]

1 Press the [CUSTOM] key.

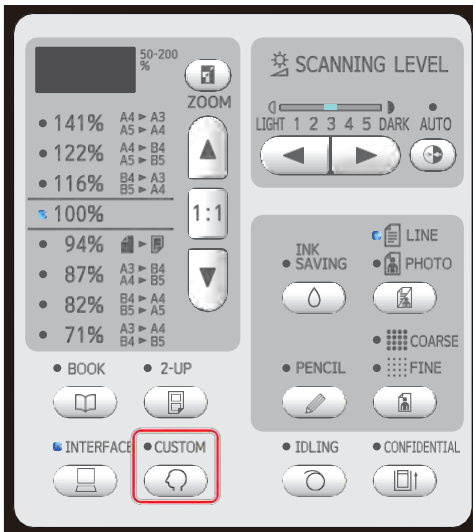

The [Custom Setting Mode] menu screen is displayed.

2 Enter the item number.

Using the numeric keys, enter the item number that you want to set.

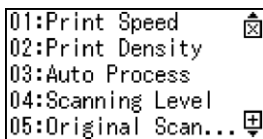

The number that you entered is displayed in the numeric display. You can change the menu that is to be displayed on the screen, using the [×] key and the [+] key.

3 Press the [START] key.

4 Enter the number of the setting value.

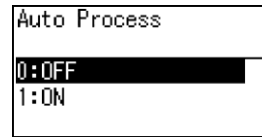

5 Press the [START] key.

The setting is complete and the [Custom Setting Mode] menu screen is displayed. If you want to change multiple setting items, repeat steps 2 to 5.



B If you want to cancel the change, press the [STOP] key instead of the [START] key.

6 Press the [START] key or the [CUSTOM] key.

A confirmation screen is displayed.



B If you want to cancel all the changes that were made in [Custom Setting Mode], press the [STOP] key instead.

7 Press the [START] key.

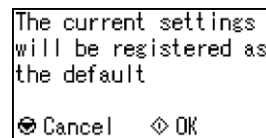



The settings that you changed are applied and the mode returns to normal.



B If you want to return to the [Custom Setting Mode] menu screen, press the [STOP] key instead of the [START] key.



List of setting items

- The factory default settings are underlined in the following list.
- The items marked with an asterisk (*) are displayed only when an optional accessory is installed.
- When [81: Authentication Setting] (A 70) is set to [ON], general users cannot browse or change the items that are marked with “g”.



Item number	Setting item	Description					
		0	1	2	3	4	5
1 g	[Print Speed] You can change the default setting of the print speed (A 46).  BWhen [28: ECO Mode] (A 64) is set to [ON], [1: Print Speed] is fixed to [2] (Level 3).	Level 1	Level 2	<u>Level 3</u>	Level 4	Level 5	
2 g	[Print Density] You can change the default setting of the print density (A 47).  BWhen [28: ECO Mode] (A 64) is set to [ON], [2: Print Density] is fixed to [0] (Level 1).	Level 1	Level 2	<u>Level 3</u>	Level 4	Level 5	
3 g	[Auto Process] You can change the default setting of [Auto Process] (A 22).	<u>OFF</u>	ON				
4 g	[Scanning Level] You can change the default setting of scanning level (A 40).	Level 1	Level 2	Level 3	Level 4	Level 5	<u>Auto</u>
5 g	[Original Scanning Mode Default Setting] You can change the default settings of [LINE/PHOTO] and [PENCIL] (A 38).	<u>Line</u>	Photo	Duo	Pencil		
6	[Original Book Size] You can change the size of the original that is to be scanned in [BOOK] (A 40). When [Paper] is set, the original is scanned with the same size as the paper that is set on the paper feed tray.	Type: mm					
		<u>Paper</u>	A3	B4	A4	B5	
		Type: inch					
		<u>Paper</u>	Ledger	Legal	Letter		
7	[Book Gutter Shadow Width] You can change the range that is to be erased in [BOOK] (A 40).	Type: mm					
		<u>20mm</u>	30mm	40mm	50mm	80mm	
		Type: inch					
		<u>13/16"</u>	1 3/16"	1 8/16"	1 31/32"	3 1/8"	

Item number	Setting item	Description					
		0	1	2	3	4	5
8 Ⓔ	[Auto Idling Time] You can set [IDLING] (A 56) to be performed automatically during the next master making if the print drum (cylinder) has not been used for a certain amount of time.	None	6 hours	<u>12 hours</u>			
9 Ⓔ	[2-Up Mode Scan Waiting Time] With [2-UP] (A 42), if a certain amount of time has elapsed without the next original being placed, master making starts automatically. This certain amount of time is referred to as [2-Up Mode Scan Waiting Time].	None	<u>15 seconds</u>	30 seconds			
10 Ⓔ	[Auto Sleep Setting] You can set this machine to go into sleep mode, in which power consumption can be reduced, if this machine has not been used for a certain amount of time. Even while this machine is in sleep mode, this machine can receive original data from the computer.	None	<u>5 minutes</u>	15 minutes	30 minutes	60 minutes	90 minutes
11 Ⓔ	[Auto Power-OFF Setting] You can set the power to be automatically turned off if this machine has not been used for a certain amount of time.	None	5 minutes	15 minutes	30 minutes	<u>60 minutes</u>	90 minutes
12 Ⓔ	[Auto Clear Time] You can configure the setting so that the setting ([Original Scanning Mode Default Setting] or [PRINT POSITION]) that was changed on the control panel returns to the default if this machine is left for a given period of time.	<u>None</u>	3 minutes	5 minutes			
13	[Paper Quality] When [Standard] is set, papers are fed according to the position of the paper-feed setting lever (A 24). When [User1] to [User5] is selected, papers are fed according to the paper-feeding conditions that you registered, regardless of the position of the paper-feed setting lever. BIn the factory default settings, nothing is registered for [User1] to [User5]. When registering the paper-feeding conditions, consult your dealer or authorized service representative.	<u>Standard</u>	User1	User2	User3	User4	User5

Item number	Setting item	Description					
		0	1	2	3	4	5
14 Ⓔ	<p>[Minimum Print Q'ty]</p> <p>You can set master making to be performed only when the entered number of printed copies is more than the specified number.</p> <p>BYou can lock the setting of [Minimum Print Q'ty], so that it cannot be changed. For more information, consult your dealer or authorized service representative.</p>	<u>0page</u>	10pages	20pages	30pages	40pages	50pages
15 Ⓔ	<p>[Beep Sound]</p> <ul style="list-style-type: none"> • When this item is set to [Level 0], no buzzer will occur. • When this item is set to [Level 1], the buzzer sounds when: <ul style="list-style-type: none"> • an error occurs; • the machine is placed into the state in which the print drum can be pulled out; or • the print drum, master disposal box, or master making unit is loaded. • When this item is set to [Level 2], in addition to the above state, but also operation sounds for items such as keys, and confirmation sounds for the completion of an operation will occur. 	<u>Level 2</u>	Level 1	Level 0			
16 Ⓔ	<p>[Reserve Period]</p> <p>Even if this machine has been left untouched after the operation stops, master making of the received original data does not start until a certain amount of time has elapsed. This certain amount of time is referred to as a "reserve period".</p>	None	<u>15 seconds</u>	30 seconds	60 seconds		
17	<p>[ADF Semi-Auto] *</p> <p>While this is set to [ON], when an original is placed on the optional auto document feeder, the following operations are performed.</p> <ul style="list-style-type: none"> • This machine pauses after master making. • Master making for the next original starts automatically after the printing process. <p> BWhen [Auto Process] (A 22) is set to on, [ADF Semi-Auto] is disabled.</p>	<u>OFF</u>	ON				

Item number	Setting item	Description					
		0	1	2	3	4	5
18	<p>[Job Separation] Set this item to [ON] when using the optional Job Separator.</p> <p>BWhen this item is set to [ON], [37: Slip Sheet Sorting] (A 64) is set to [OFF].</p>	<u>OFF</u>	ON				
19	<p>[Quick Master Making] When this item is set to [ON], you can shorten the time required for master making. The icon that is displayed in the master making basic screen changes according to the [OFF] and [ON] settings.</p> <ul style="list-style-type: none"> • [OFF]:  • [ON]:  <p> BWhen master making is performed with this item set to [ON], images are printed at a lower resolution.</p> <p>BWhen this item is set to [ON], [38: Paper Memory Print] (A 65) is set to [OFF].</p> <p>BWhen you set the following functions, [Quick Master Making] is disabled.</p> <p>C[Size] (A 41) C[2-UP] (A 42) C[BOOK] (A 40)</p>	<u>OFF</u>	ON				
20	<p>[Print Count Hold Setting]</p> <ul style="list-style-type: none"> • When this item is set to [Return], the numeric display returns to the set number of sheets after printing is complete. (Example: When printing with the number of prints set to “100”, the numeric display returns to “100”.) • When this item is set to [Do Not Return], the numeric display remains “0” after printing is complete. 	<u>Do Not Return</u>	Return				
21	<p>[2-Up Print Hold Setting]</p> <ul style="list-style-type: none"> • When this item is set to [Return], [2-UP] remains on after master making or printing by [2-UP] is complete. • When this item is set to [Do Not Return], [2-UP] turns off after master making or printing by [2-UP] is complete. 	<u>Do Not Return</u>	Return				

Item number	Setting item	Description					
		0	1	2	3	4	5
22	<p>[Separation Fan] Adjust this item if unevenness or blurring occurs in printed images, depending on the image conditions of the original or the type of paper.</p> <p>BFor appropriate adjustment values, consult your dealer or authorized service representative.</p>	OFF	Level 1 (Low)	Level 2	<u>Level 3</u>	Level 4 (High)	
23	<p>[Suction Fan] Adjust this item if unevenness or blurring occurs in printed images, depending on the image conditions of the original or the type of paper.</p> <p>BFor appropriate adjustment values, consult your dealer or authorized service representative.</p>	Level 1 (Low)	Level 2	<u>Level 3</u>	Level 4 (High)		
24	<p>[Duo Mode Setting] You can change the image processing of [Duo] (A 39).</p> <p>[Standard] Select this option when you want to reproduce characters and photos with good balance. This option is also suitable for colored originals.</p> <p>[Line] Select this option to emphasize the clearness of characters. This is also suitable when the original contains a photo with clear contrast, such as buildings and gloss on metallic surfaces.</p> <p>[Photo] Select this option when the original contains a photo in which smoothness of gradation is important, such as food and portrait photos.</p> <p>[ON/OFF] Select [ON] to clear the background color of the dark-colored originals, such as newspapers.</p>	<u>Standard/</u> <u>OFF</u>	Standard/ ON	Line/ OFF	Line/ ON	Photo/ OFF	Photo/ ON
25	<p>[Pencil Mode Setting] You can change the image processing of [PENCIL] (A 39). Select [Lighter] when the shadows in a cut-and-paste original are included in the master.</p>	<u>Darker</u>	Lighter				

Item number	Setting item	Description					
		0	1	2	3	4	5
28 ☒	<p>[ECO Mode] You can print with reduced power consumption at a lower printing pressure than normal printing. When this item is set to [ON], neither [1: Print Speed] nor [2: Print Density] under [Custom Setting Mode] (A 59) can be changed any more.</p>	<u>OFF</u>	ON				
29 ☒	<p>[Display Language] You can change the language to be displayed on the screen.</p> <p> When changing the setting, consult your dealer or authorized service representative.</p>	<p>0 and on</p> <p>A number is assigned to each language. You can change the displayed language by selecting the number of the language that you want to display.</p>					
31	<p>[Display Density] You can adjust the density of the screen display.</p>	Level 1 to <u>Level 5</u> to Level 9					
32	<p>[LCD Brightness] You can adjust the brightness of the screen display.</p>	Level 1	Level 2	<u>Level 3</u>	Level 4	Level 5	
36	<p>[D-Feed Check] This machine is equipped with the [D-Feed Check] function, which automatically stops printing when the feeding of overlapped sheets of paper (double feeding) is detected. Turn OFF [D-Feed Check] in the following cases:</p> <ul style="list-style-type: none"> • A [D-Feed Check] error is repeatedly displayed when no double feeding occurs. • Paper with a dark ground color is used (such as black, red, or deep blue). • The back side of the paper is already printed. <p>BWhen this item is set to [ON], the icon () is displayed on the printing basic screen.</p>	OFF	<u>ON</u>				
37	<p>[Slip Sheet Sorting] You can use the paper placed on the paper feed tray as slip sheets for sorting printed papers. (A 79 "Inserting Slip Sheet [Slip Sheet Sorting]")</p> <p>BWhen this item is set to [ON], [18: Job Separation] (A 62) is set to [OFF].</p>	<u>OFF</u>	ON				

Item number	Setting item	Description					
		0	1	2	3	4	5
38	<p>[Paper Memory Print] Even if this machine cannot be connected to a computer, you can still perform high-resolution printing similar to printing that is performed directly from a computer. (A 79 “Using Paper Memory Original [Paper Memory Print]”)</p> <p>BWhen this item is set to [ON], [19: Quick Master Makingn] (A 62) is set to [OFF].</p>	<u>OFF</u>	ON				
50	<p>[Count:A4/Letter and Smaller] Shows the accumulated number of copies that was printed on papers smaller than A4 in this machine. The value does not include proof copies that were output during master making.</p>	A 77 “Displaying the Accumulated Counts [Meter Display]”					
51	<p>[Count:Larger than A4/Letter] Shows the accumulated number of copies that was printed on papers larger than A4 in this machine. The value does not include proof copies that were output during master making.</p>	A 77 “Displaying the Accumulated Counts [Meter Display]”					
52	<p>[Total Print Count Display] Shows the accumulated number of copies that have been printed on this machine. The value does not include proof copies that were output during master making.</p>	A 77 “Displaying the Accumulated Counts [Meter Display]”					
53	<p>[Total Master Count Display] Shows the accumulated count of master making processes that have been performed on this machine. The value includes the count of [IDLING] and [CONFIDENTIAL] that have been performed.</p>	A 77 “Displaying the Accumulated Counts [Meter Display]”					

Item number	Setting item	Description					
		0	1	2	3	4	5
54	[Drum Count] Shows the accumulated number of copies that have been printed using the current print drum (cylinder). The value includes the count of proof copies that were output during master making. To check the accumulated number of copies that was printed using another print drum (cylinder), change the print drum (cylinder) and then display the [Drum Count] screen.	A 77 "Displaying the Accumulated Counts [Meter Display]"					
70 g	[IP Address(IPv4)] *	A 68 "Connecting to the Network"					
71 g	[IP Address(IPv6)] *	A 68 "Connecting to the Network"					
75 g	[LAN Interface] * You can specify the physical network type. Leave [AUTO] selected for most cases.	AUTO	10HALF	10FULL	100HALF	100FULL	
76 g	[Initialize Network] * You can restore the settings of [70: IP Address(IPv4)], [71: IP Address(IPv6)], and [Network] for the RISO Console (A 87) to the factory default settings.	Cancel	OK				
80 g	[User Registration] Register the users who use this machine.	A 70 "Using the Authentication Function"					
81 g	[Authentication Setting] You can turn on / off the authentication function.	A 70 "Using the Authentication Function"					
82 g	[Disable] You can prohibit the use of this machine for specified users.	A 70 "Using the Authentication Function"					
83 g	[Limit T/C] You can set the upper limit of the number of printed sheets (Total Count) for each user.	A 70 "Using the Authentication Function"					
84 g	[Limit M/C] You can set the upper limit of the number of master making processes (Master Count) for each user.	A 70 "Using the Authentication Function"					
85 g	[Clear T/C] You can clear the number of printed sheets (Total Count) up to the present.	A 70 "Using the Authentication Function"					

Item number	Setting item	Description					
		0	1	2	3	4	5
86 Ⓔ	[Clear M/C] You can clear the number of master making processes (Master Count) up to the present.	A 70 "Using the Authentication Function"					
87 Ⓔ	[Reset Counter] You can clear the number of printed sheets and the number of master making processes for all users collectively.	A 70 "Using the Authentication Function"					
88 Ⓔ	[Set Date] You can display the report screen for [Count Report Output] on the specified date of every month.	A 70 "Using the Authentication Function"					
89 Ⓔ	[Clear Count Error] You can hide the report screen for [Count Report Output] of the month.	A 70 "Using the Authentication Function"					
90 Ⓔ	[Count Report Output] You can output the total results for the number of printed sheets and the number of master making processes for all users. Select the output method in advance with [91: Setting of Count Report].	A 70 "Using the Authentication Function"					
91 Ⓔ	[Setting of Count Report] Set the output method of [90: Count Report Output].	A 70 "Using the Authentication Function"					
92 Ⓔ	[Authentication Method] * This setting item is displayed when the optional IC Card Reader is installed. Select the method of authentication operation.	A 70 "Using the Authentication Function"					
95 Ⓔ	[Clear Authentication Setting] You can restore all the settings for item numbers 80 to 92, which are related to the authentication function, to the factory default settings.	A 70 "Using the Authentication Function"					
99 Ⓔ	[Reset to Default Setting] You can restore all the settings of [Custom Setting Mode] to the factory default settings.	Cancel	OK				

Connecting to the Network

To connect this machine to a network, perform settings such as the IP address according to the connection environment.

! To connect the SF5430EII/SF5330EII/SF5230EII/SF5130EII/SF5030EII to the network, the optional network kit (A 124) is required.

When connecting to the IPv4 network

Set this item when you allocate an Internet Protocol version 4 address to this machine.

1 Enter item number “70” in [Custom Setting Mode].

2 Press the [START] key.

3 Enter the number of the setting method.

IP Address (IPv4)
0: Auto
1: Manual

4 Press the [START] key.

- When [0: Auto] is set: Go to step 11.
- When [1: Manual] is set: Go to step 5.

5 Enter the IP address of this machine.

IP Address (IPv4)
000.000.000.000

- After entering three digits, press the [+] key to go to the next three digits.
- Press the [x] key to return.

! Press the [C] key to return the three digits that you are currently entering to [000].

! Press the [RESET] key to return all the values that you entered to [0].

6 Press the [START] key.

! You can also go to the next step by pressing the [+] key.

7 Enter the subnet mask.

The entering procedure is the same as step 5.

Subnet Mask (IPv4)
000.000.000.000

8 Press the [START] key.

! You can also go to the next step by pressing the [+] key.

9 Enter the default gateway.

The entering procedure is the same as step 5.

Default Gateway (IPv4)
000.000.000.000

10 Press the [START] key.

! You can also go to the next step by pressing the [+] key.

11 Enter the IP address of the DNS server (primary).

The entering procedure is the same as step 5.

DNS (IPv4-Primary)
000.000.000.000

12 Press the [START] key.

! You can also go to the next step by pressing the [+] key.

13 Enter the IP address of the DNS server (secondary).

The entering procedure is the same as step 5.

DNS (IPv4-Secondary)
000.000.000.000

14 Press the [START] key.

The setting is complete and the menu screen is displayed.

When connecting to the IPv6 network

Set this item when you allocate an Internet Protocol version 6 address to this machine.

1 Enter item number "71" in [Custom Setting Mode].

2 Press the [START] key.

3 Enter the number of the setting method.

IP Address (IPv6)
0: Manual
1: Stateless
2: Stateful

4 Press the [START] key.

- When [0: Manual] is set:
Go to step 5.
- When either [1: Stateless] or [2: Stateful] is set:
Go to step 11.

5 Enter the IP address of this machine.

IP Address (IPv6)
0000:0000:0000:0000: 0000:0000:0000:0000
bcdef0123456789

- 1 Press the [] and [] keys for the print position adjustment to select the value (alphabet and numeric values) to be entered from the field at the bottom of the screen.

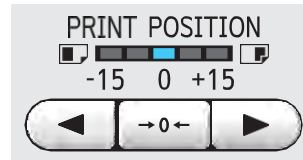

- 2 Press the [] key for the print position adjustment to confirm the value that you entered. (You can also enter numeric values by using the numeric keys.)



B Press the [N] key for the print speed adjustment to move the entry destination to the next digit.

B Press the [O] key for the print speed adjustment to return the entry destination to the previous digit.

B Press the [C] key to return the four digits that you are currently entering to [0000].

B Press the [RESET] key to return all the values that you entered to [0].

- 3 After entering four digits, press the [+] key to go to the next four digits.

6 Press the [START] key.



B You can also go to the next step by pressing the [+] key.

6

7 Enter the prefix length.

Prefix (IPv6)
064

8 Press the [START] key.



B You can also go to the next step by pressing the [+] key.

9 Enter the IP address of the default gateway.

The entering procedure is the same as step 5.

Default Gateway (IPv6)
0000:0000:0000:0000:
0000:0000:0000:0000
bcdef0123456789

10 Press the [START] key.



You can also go to the next step by pressing the [+] key.

11 Enter the IP address of the DNS server (primary).

The entering procedure is the same as step 5.

DNS (IPv6-Primary)
0000:0000:0000:0000:
0000:0000:0000:0000
bcdef0123456789

12 Press the [START] key.



You can also go to the next step by pressing the [+] key.

13 Enter the IP address of the DNS server (secondary).

The entering procedure is the same as step 5.

DNS (IPv6-Secondary)
0000:0000:0000:0000:
0000:0000:0000:0000
bcdef0123456789

14 Press the [START] key.

The setting is complete and the menu screen is displayed.

Using the Authentication Function

“Authentication” means to identify the user of this machine by using the PIN code and IC card that are assigned to each user. User identification enables individual user management and enhanced security.

■ Setting items that are required for using the authentication function

Perform the following settings in [Custom Setting

Item number	Setting item
92	[Authentication Method] This setting item is displayed when the optional IC Card Reader is installed. Select the method of authentication operation from “0: PIN Code” and “1: IC Card”.
80	[User Registration] Register the users who use this machine. For the registration procedure, see the description below.
81	[Authentication Setting] You can turn on / off the authentication function. When this item is set to [1: ON], authentication operation is required when this machine is started up.

[User Registration]

Register the users who use this machine. The number of users that can be registered varies depending on the [Authentication Method].

[Authentication Method]	Available "Authentication registration numbers"
[0:PIN Code]	No.0 to 99
[1:IC Card]	No.0 to 499

Those users are categorized into “general user” and “administrator”.

■ What is “general user”?

“Authentication registration numbers” are assigned to the users who have been registered in this machine. The users who have been registered for any numbers from authentication registration number 1 are called “general users”. General users cannot browse or change some of the items in [Custom Setting Mode].



For the items that general users cannot browse or change, see “List of setting items” for [Custom Setting Mode] (A 59). The item numbers are marked with “g”.

■ What is “administrator”?

The user who has been registered for authentication registration number 0 is called “administrator”.

The administrator can browse and change all items in [Custom Setting Mode].

1 Enter item number “80” in [Custom Setting Mode].

2 Press the [START] key.

The [User Registration] screen is displayed.

3 Press the [+] key.

4 Enter the authentication registration number of the user that you want to register or change.

If the administrator (authentication registration number: 0) is not registered, it is necessary to register it first.

User Registration
User
[0]
Back Next

5 Press the [+] key.

Go to step 6.

If [Authentication Method] (A 70) is set to [1: IC Card], go to step 8.

6 Enter a new PIN code.

You can enter up to four digits.

The entered code is displayed as “j”.

Enter the PIN code
User-0
[j]
Back Next

7 Press the [+] key.

Go to step 9.

8 Touch the IC card to the IC Card Reader.

When the IC card is read correctly, the [Enter the Group No.] screen is displayed.

9 Enter the group number.

You can set the group (department, etc.) to which the user belongs. Once a group is set, the total count for each group is displayed in the total results output with [90: Count Report Output] (A 74).

You can set numbers 1 to 32.

If no group is to be set, enter “0”.

Enter the Group No.
User-0
[0]
Back Next

10 Press the [+] key.

The user is registered.

To continue setting other users, repeat steps 4 to 10.

11 Press the [START] key.

The setting is complete and the menu screen is displayed.

[Disable]

You can prohibit the use of this machine for specified users. To cancel the disabled state, switch this item to [0:OFF] using the same steps.



Administrator usage of this machine cannot be disabled.

1 Enter item number “82” in [Custom Setting Mode].

2 Press the [START] key.

The [Disable] screen is displayed.

3 Press the [+] key.

4 Enter the authentication registration number of the target user.

Disable
User
[1]
Back Next

5 Press the [+] key.**6 Enter the number of the setting.**

0:OFF (Able)
1:ON (Disable)

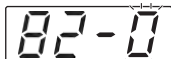
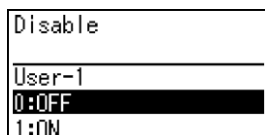
**7 Press the [+]** key.

The settings that you changed are confirmed.
To continue setting other users, repeat steps 4 to 7.

8 Press the [START] key.

The setting is complete and the menu screen is displayed.

[Limit T/C] [Limit M/C]

You can set the upper limit of the number of printed sheets and the number of master making processes for each user.

1 Enter the item number in [Custom Setting Mode].

Enter either of the following item numbers.

Item number	Setting item
83	[Limit T/C] You can set the upper limit of the number of printed sheets. "T/C" is an abbreviation for "Total Count".
84	[Limit M/C] You can set the upper limit of the number of master making processes. "M/C" is an abbreviation for "Master Count".

The setting procedures of [Limit T/C] and [Limit M/C] are the same. The following example describes the procedure for setting [Limit T/C].

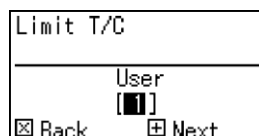
2 Press the [START] key.**3 Press the [+]** key.**4 Enter the authentication registration number of the target user.****5 Press the [+]** key.**6 Enter the upper limit of the number of printed sheets you want to set.**

When "0" is set, "no limit" is applied.

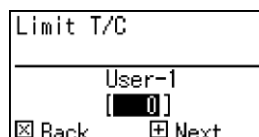
**7 Press the [+]** key.

The settings that you changed are confirmed.
To continue setting other users, repeat steps 4 to 7.

8 Press the [START] key.

The setting is complete and the menu screen is displayed.

[Clear T/C] [Clear M/C]

You can clear the number of printed sheets or the number of master making processes up to the present. You can designate each user or all users as the target for clearing.



B [87: Reset Counter] (**A** 73) is useful when you want to clear the number of printed sheets and number of master making processes for all users collectively.

1 Enter the item number in [Custom Setting Mode].

Enter either of the following item numbers.

Item number	Setting item
85	[Clear T/C] You can clear the number of printed sheets up to the present. "T/C" is an abbreviation for "Total Count".
86	[Clear M/C] You can clear the number of master making processes up to the present. "M/C" is an abbreviation for "Master Count".

The setting procedures of [85: Clear T/C] and [86: Clear M/C] are the same. The following example describes the procedure for setting [85: Clear T/C].

2 Press the [START] key.

3 Press the [+] key.

4 Enter the authentication registration number of the target user.

To designate all users as a target for clearing, enter "00".

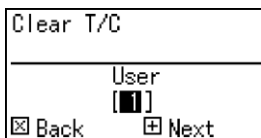

5 Press the [+] key.

The preset upper limit of the number of printed sheets is displayed.

6 Press the [+] key.

The number of printed sheets up to the present is displayed.

7 Press the [C] key.

The displayed number of printed sheets is cleared.

8 Press the [+] key.

Clearing of the number of printed sheets is confirmed.

To continue clearing the number of printed sheets for other users, repeat steps 4 to 8.

9 Press the [START] key.

The menu screen is displayed.

[Reset Counter]

You can clear the number of printed sheets and number of master making processes for all users collectively.



B Once clearing is executed, it is not possible to return to the status before clearing.

1 Enter item number "87" in [Custom Setting Mode].

2 Press the [START] key.

3 Enter [1].

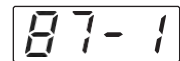
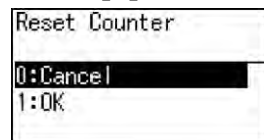

4 Press the [START] key.

Clearing is executed.

Once clearing is complete, the menu screen is displayed.

[Set Date]

You can display the report screen (A 110) for [90: Count Report Output] on the specified date of every month.



B Register the "administrator" in [80: User Registration] (A 70) in advance.

1 Enter item number "88" in [Custom Setting Mode].

2 Press the [START] key.

3 Enter the notification day.

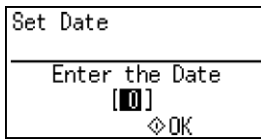

B When this item is set to [0], the report screen is not displayed.

B When you set any date from [29] to [31], the report screen is displayed on the last day of the month if the specified date does not exist in the month, for example, February.

4 Press the [START] key.

The menu screen is displayed.

[Clear Count Error]

Once you specify a date for [88: Set Date], a warning screen is displayed each time the power is turned on until [90: Count Report Output] is executed. If you do not want to perform [90: Count Report Output] for the current month, perform [89: Clear Count Error]. The warning screen is not displayed until the notification day of the next month.

1 Enter item number “89” in [Custom Setting Mode].

2 Press the [START] key.

3 Enter [1].

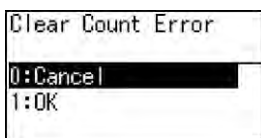

4 Press the [START] key.

Clearing is executed.

Once clearing is complete, the menu screen is displayed.

[Count Report Output]

You can output the total results for the number of printed sheets and the number of master making processes for all users.



B Register the “administrator” in [80: User Registration] (A 70) in advance.

B Select the output method in [91: Setting of Count Report] (A 75) in advance.

■ To print

1 Check the paper.

To execute [90: Count Report Output], a paper larger than A4 size is required.

(A 24 “Setting up the paper feed tray and the paper”)

2 Enter item number “90” in [Custom Setting Mode].

3 Press the [START] key.

4 Enter [1].

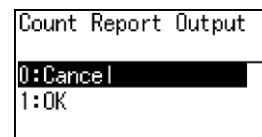

5 Press the [START] key.

The total results are printed.

Once printing is complete, the menu screen is displayed.

■ To save in a USB flash drive

- 1 Insert the USB flash drive into the USB port.

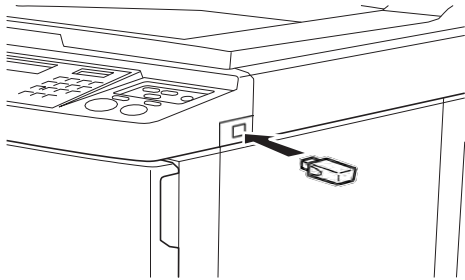

- 2 Enter item number "90" in [Custom Setting Mode].

- 3 Press the [START] key.

- 4 Enter [1].

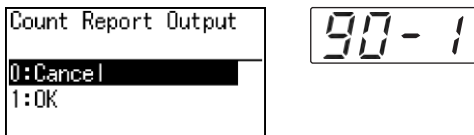

- 5 Press the [START] key.

The total results are saved in the USB flash drive as a CSV file. Once saving is complete, the menu screen is displayed.

- 6 Remove the USB flash drive.

■ To send by e-mail

- 1 Enter item number "90" in [Custom Setting Mode].

- 2 Press the [START] key.

- 3 Enter [1].

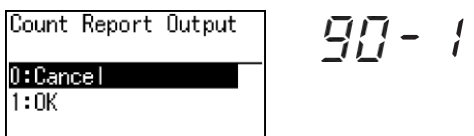

- 4 Press the [START] key.

The total results are saved as a CSV file and attached to an e-mail. The e-mail is sent to e-mail addresses that have been specified in advance. Once sending the e-mail is complete, the menu screen is displayed.

[Setting of Count Report]

Select from the following for the output method of [90: Count Report Output] (A 74).

- Printing with this machine
- Saving in a USB flash drive as a CSV file
- Sending a CSV file by e-mail

! Register the "administrator" in [80: User Registration] (A 70) in advance.

B The included "RISO COPY COUNT VIEWER" is useful for managing saved CSV files.

- 1 Enter item number "91" in [Custom Setting Mode].

- 2 Press the [START] key.

- 3 Enter the number of the setting.

- 0: Print
- 1: USB Flash Drive
- 2: Mail

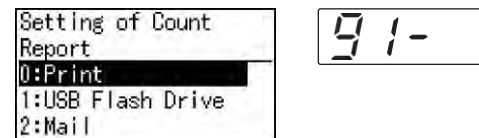

! If [2:Mail] is not displayed, special settings are required. For more information, consult your dealer or authorized service representative.

B To send an e-mail, perform the procedure "Presetting for [2:Mail]" in advance.

- 4 Press the [START] key.

The setting is complete and the menu screen is displayed.

■ Presetting for [2:Mail]

- 1 Access the RISO Console from the computer.

(A 84 "Accessing RISO Console")

- 2 Log in to the RISO Console.

(A 84 "Logging in")

- 3 Click [Network].

(A 87 "[Network] Menu")

- 4 Click [SMTP Setting].

5 Set [Use] for [SMTP Authentication].

6 Perform the required settings for [Counter Info. Mail].



For the SMTP server settings, please contact your network administrator.

■ [Send]

Select [Send].

■ [Use SMTP Authentication]

Select either option as necessary.

■ [User name]

When you have selected the [Use] option for [Use SMTP Authentication], enter the user name for SMTP authentication.

■ [Password]

When you have selected the [Use] option for [Use SMTP Authentication], enter the password for SMTP authentication.

■ [SMTP Server Name]

Enter the SMTP server name.

■ [Sender Address]

Enter an e-mail address of a person, such as a person in charge of managing this machine.

■ [Receiver Address 1], [Receiver Address 2]

You can specify up to two e-mail destinations.

■ [Port No.]

Enter the port number of the SMTP server.

■ [Subject]

Enter a subject for the e-mail as necessary.

■ [Message (Add Comment)]

Enter the body of the e-mail as necessary.

■ [Signature]

Enter a signature to be contained in the body of the e-mail as necessary.

■ [Send Transmission Result to Administrator]

When you select [Send], the result of e-mail transmission (success or failure) is sent to the address specified in [Administrator Address].

■ [Administrator Address]

If you select the [Send] option for [Send Transmission Result to Administrator], enter the destination address for the result of e-mail transmission.

■ [Subject]

Enter a subject for the e-mail that indicates the result of e-mail transmission as necessary.

■ [Signature]

Enter a signature to be contained in the body of the e-mail that indicates the result of e-mail transmission as necessary.

7 Click [OK] located at the bottom of the screen.

The settings that you changed are applied.

[Clear Authentication Setting]

You can restore all the settings for item numbers 80 to 92, which are related to the authentication function, to the factory default settings.



Once clearing is executed, it is not possible to return to the status before clearing.

1 Enter item number "95" in [Custom Setting Mode].

2 Press the [START] key.

3 Enter [1].

95-1

4 Press the [START] key.

Clearing is executed.

Once clearing is complete, the menu screen is displayed.

Displaying the Accumulated Counts [Meter Display]

You can check the accumulated results for the count of master making processes and the number of printed sheets.

1 Press the number of the item that you want to check in [Custom Setting Mode].

Item number	Setting item
50	[Count:A4/Letter and Smaller] Shows the accumulated number of copies that was printed on papers smaller than A4 in this machine. The value does not include proof copies that were output during master making.
51	[Count:Larger than A4/Letter] Shows the accumulated number of copies that was printed on papers larger than A4 in this machine. The value does not include proof copies that were output during master making.
52	[Total Print Count Display] Shows the accumulated number of copies that have been printed on this machine. The value does not include proof copies that were output during master making.
53	[Total Master Count Display] Shows the accumulated count of master making processes that have been performed on this machine. The value includes the count of [IDLING] and [CONFIDENTIAL] that have been performed.

Item number	Setting item
54	[Drum Count] Shows the accumulated number of copies that have been printed using the current print drum (cylinder). The value includes the count of proof copies that were output during master making. To check the accumulated number of copies that was printed using another print drum (cylinder), change the print drum (cylinder) and then display the [Drum Count] screen.

2 Press the [START] key.

3 Check the contents in the display.

4 Press the [START] key or the [STOP] key.

The menu screen is displayed.

Adjusting Paper Feeding and Receiving Conditions [Special Paper Control]

You can adjust the paper feeding and paper receiving conditions when using special paper or when unevenness and blurring occur in printed images.

Paper feeding adjustment for special paper [Paper Quality]

When [Standard] is set in [13: Paper Quality] (A 60), papers are fed according to the position of the paper-feed setting lever (A 24).

When [User1] to [User5] is selected, papers are fed according to the paper-feeding conditions that you registered, regardless of the position of the paper-feed setting lever.



B In the factory default settings, nothing is registered for [User1] to [User5]. When registering the paper-feeding conditions, consult your dealer or authorized service representative.

1 Press item number “13” in [Custom Setting Mode].

2 Press the [START] key.

3 Enter the number of the setting value.

Enter [1] (User1) to [5] (User5).



B For appropriate adjustment values, consult your dealer or authorized service representative.

4 Press the [START] key.

The setting is completed and the [Custom Setting Mode] menu screen is displayed.

Paper receiving adjustment for special paper [Separation Fan] [Suction Fan]

You can adjust the paper receiving conditions depending on the characteristics of the printed image and the paper.

1 Enter the item number in [Custom Setting Mode].

Enter either of the following item numbers.

Item number	Setting item
22	[Separation Fan]
23	[Suction Fan]

2 Press the [START] key.

3 Enter the number of the setting value.

Refer to the following page for details.

- [22: Separation Fan] (A 63)
- [23: Suction Fan] (A 63)



B For appropriate adjustment values, consult your dealer or authorized service representative.

4 Press the [START] key.

The setting is completed and the [Custom Setting Mode] menu screen is displayed.



B You can also adjust the paper receiving conditions by the following items.

- C Paper arrangers (A 26)
- C Jumping wings (A 26)
- C Corrugators (A 27)

Inserting Slip Sheet [Slip Sheet Sorting]

- You can use the paper placed on the paper feed tray as slip sheets for sorting printed papers.
- When you print with [Auto Process] turned on after placing originals on the auto document feeder, turn on [Slip Sheet Sorting] to insert a slip sheet (blank sheet) each time the original changes.
 - When you use [Program] (A 52) together with [Slip Sheet Sorting], a slip sheet (blank sheet) is inserted between each separation of the printing.



B[Slip Sheet Sorting] can be used when the following papers are placed on the paper feed tray:
(Standard sizes)
SF5350EII/SF5250EII/SF5330EII/SF5230EII/SF5030EII: A3p, B4p, A4p, or Foolscapp
SF5450EII/SF5430EII/SF5130EII: Ledgerp, Legalp or Letterp
(Custom sizes)
210 mm × 280 mm to 310 mm × 432 mm
(8 1/4 inches × 11 1/32 inches to 12 7/32 inches × 17 inches)

BSlip sheets and printed papers may be smudged with ink.



- B**This function works only when [Program] (A 52) or [Auto Process] (A 22) is [ON].
- B**You cannot use this function with the following functions.
- C**[High Speed] under [SPEED](A 46).

1 Enter item number “37” in [Custom Setting Mode].

2 Press the [START] key.

3 Enter [1].

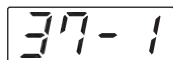
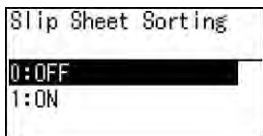

BWhen [37: Slip Sheet Sorting] is set to [ON], [18: Job Separation] (A 62) is set to [OFF].

4 Press the [START] key.
 The [Custom Setting Mode] menu screen is displayed.

Using Paper Memory Original [Paper Memory Print]

Even if this machine cannot be connected to a computer, you can still perform high-resolution printing similar to printing that is performed directly from a computer.

Using the RISO Printer Driver function, you can convert original data created on a computer into a digital pattern, and then print it with a laser printer*. The paper is called a “Paper Memory Original”. You can use the [Paper Memory Print] function of this machine to reproduce and print the source original data from the Paper Memory Original.

* A laser printer of 600 dpi or more is required to create a Paper Memory Original. However, this machine may not be able to scan it properly depending on the model and print quality of the laser printer.

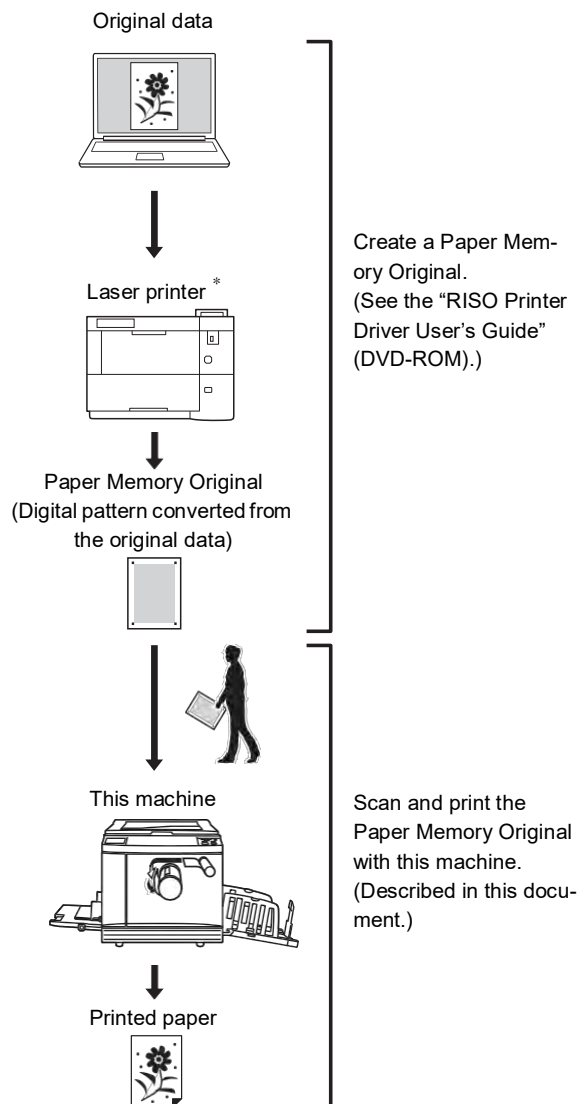

This section describes the procedure to scan and print Paper Memory Originals with this machine.

! **B** To create a paper memory original, the RISO printer driver for Windows version is required. The printer driver for Mac version is not available for this purpose.

1 Enter item number "82" in [Custom Setting Mode].

2 Press the [START] key.

3 Enter [1].

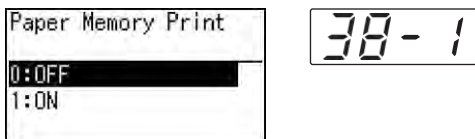

! **B** When [38: Paper Memory Print] is set to [ON], [19: Quick Master Making] (A 62) is set to [OFF].

4 Press the [START] key.
The [Custom Setting Mode] menu screen is displayed.

5 Press the [START] key.
The settings that you changed are applied and the mode returns to normal.



Check that the Paper Memory Print icon (P.M) is displayed on the screen.

6 Place the paper.
Check the header section of the Paper Memory Original. Place paper of the size printed on the header section.

7 Place a Paper Memory Original on the glass platen.
Confirm that "P.1" is printed on the header section of the Paper Memory Original.

Check that the model printed on the footer section of the paper memory original matches your printer.

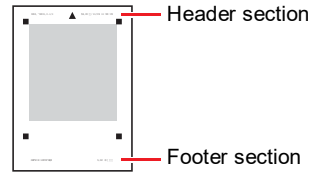

When placing the original, turn it so the printed side is facing down. Then align the center of the original with the [P.M] mark. Then, close the platen cover.

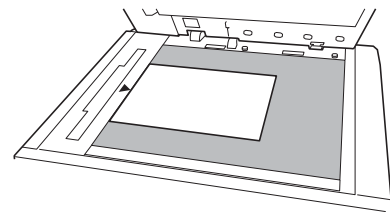

! **B** This machine may not be able to scan the Paper Memory Original properly in the following cases:

- C** The glass platen or platen cover pad is stained.
- C** The Paper Memory Original is stained, wrinkled, or creased.

B Use the margin as shown below to write notes on the Paper Memory Original. If anything is written in other areas of the Paper Memory Original, this machine may not be able to scan the Paper Memory Original properly.

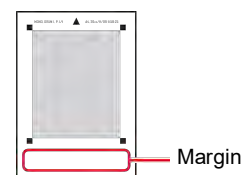

8 Press the [START] key.

The Paper Memory Original is scanned.



B When you have multiple pages of the Paper Memory Original, after the scanning of the original is complete, replace the original with the next page number and press the [START] key.

B When you want to stop the job, press the [RESET] key.

When the last original is scanned, the master making process starts.

The rest of the procedure is the same as the normal printing operation of paper originals.
(A 29 "Printing of Paper Originals")

9 Set [Paper Memory Print] to OFF.

When printing is completed, follow the below steps to set [Paper Memory Print] to OFF.

- 1 Press the [CUSTOM] key.
- 2 Enter item number "82".
- 3 Press the [START] key.
- 4 Enter [0].
- 5 Press the [START] key twice to return to the normal mode.



Chapter 7

RISO Console

RISO Console

“RISO Console” is a function for remotely operating this machine using a Web browser. You can check the status of this machine and change the settings from a computer that is connected via a network.



To connect the SF5430EII/SF5330EII/SF5230EII/SF5130EII/SF5030EII to the network, the optional network kit (A 124) is required.

Compatible Web browser

OS	Web browser
Windows	Internet Explorer 11 Microsoft Edge
Mac OS	Safari 6 Safari 7 Safari 8 Safari 9 Safari 10 Safari 11 Safari 12

Accessing RISO Console

- 1 Start up a Web browser.
- 2 Enter the IP address of this machine.

Entry example:

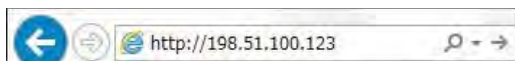

For the IP address of this machine, contact your administrator.

- 3 Press the [Enter] key.
The [Monitoring] menu screen for the RISO Console is displayed.

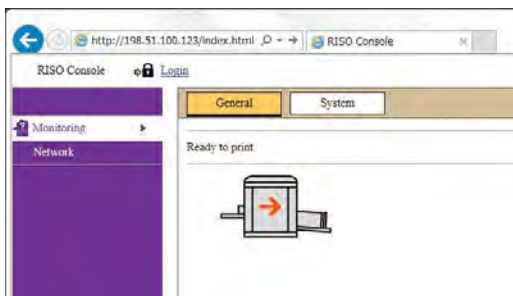

Logging in

In order to perform the following operations, it is necessary to log in to the RISO Console.

- Browsing the [Printer] menu screen
- Changing the settings on the [Network] menu screen (login is not necessary for browsing)

- 1 Click [Login].

- 2 Enter [User name] and [Password].

[User name]

Enter “admin” (lower-case, single-byte characters).

You cannot change the user name.

[Password]

This is the password that has been set in the [User] tab screen (A 85) on the RISO Console. The password that was set by default at the time of factory shipment is “admin” (lower-case, single-byte characters).

- 3 Click [OK].

Logging out

- 1 Click [Logout].

When you log out, the user name display goes off and [Login] is displayed.

[Monitoring] Menu

You can check the status of this machine and system information, and also change the login password.

[General] tab screen

You can check the status of this machine.

Consumables Amount	Paper size	Paper finish
Standard tray	B4	Standard
Master		
Ink		

Disposal Box Space
Disposal Box

Drum Information	Size	Ink Color
Print Drum	B4	

■ Status of this machine

Shows a message such as [Ready to print.] or [Sleeping.]. If an error occurs in this machine, an error message is displayed.

■ Consumables Amount

[Standard tray]

Shows [Paper size] and [Paper finish] of papers on the paper feed tray.

[Master]

Shows the remaining amount of masters that are set in this machine.

If the remaining amount is low, the remaining amount indicator blinks.

[Ink]

Shows the remaining amount of ink that is set in this machine.

If the remaining amount is low, the remaining amount indicator blinks.

■ Disposal Box Space

Shows the remaining amount of space in the master disposal box.

If the amount of space is low, the remaining amount indicator blinks.

■ Drum Information

Shows the size and color of the print drum (cylinder) that is set in this machine.

[System] tab screen

You can check the system information of this machine.

[System]	
Printer Name:	RISO SF5x50EII Series 000000
Model:	RISO SF5350EII
Serial No.:	000000000
MAC address:	00-00-00-00-00-00
Firmware:	RCMS 00.00.00

[Printer Information]	
Print Speed:	Level 3
Print Density:	Level 3
Resolution:	300 x 600 dpi
Copy Count:	38161

[User] tab screen

You can change the password for logging in to the RISO Console.

1 Click [Change password].

General	System	User
User name: admin		
Change password		

2 Enter a new password.

User > Change password

New password
 - - - (0-16 characters)

Input again for confirmation.
 New password
 - - -

OK Cancel

3 Click [OK].

The [Done] screen is displayed.

4 Click [OK].

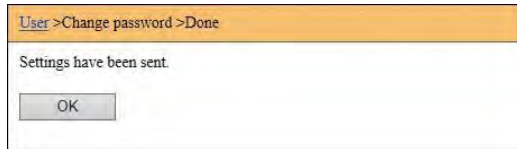

[Printer] Menu

You can check a list of the original data that is currently being processed in this machine.

Job name	Owner	Received
Microsoft Word - 1	japengfei	2015-02-09 18:11
Microsoft Word - 2	japengfei	2015-02-09 18:12
Microsoft Word - 3	japengfei	2015-02-09 18:13

- Clicking the heading line ([Job name][Owner][Received]) changes the sorting order.
- You can select the number of items to be listed from [Show 50 items] and [Show 100 items].

[Network] Menu

You can check and change the settings that are related to the network connection of this machine.



When you click an item, the setting screen for the relevant item is displayed.

[Network setting] screen

This screen is used for the connection settings of this machine to the network.

The screenshot shows the "Network setting" dialog box. It includes fields for Printer Name, Model, and MAC address. Below these are sections for DHCP (IPv4), Address Setting (IPv4), DNS (IPv4), and DNS (IPv6). The DHCP section has radio buttons for "Not Use" and "Use". The Address Setting section has a dropdown for "Stateful address". The DNS sections have input fields for Primary and Secondary addresses for both IPv4 and IPv6. At the bottom are "OK" and "Cancel" buttons.

Clicking [OK] updates the changes.

[SNMP Setting] screen

This screen is used for the SNMP (Simple Network Management Protocol) settings. Set in accordance with the network environment.

The screenshot shows the "SNMP Setting" dialog box. It includes fields for Authentication Community, SysContact, SysName, and SysLocation. There are also radio buttons for "Prohibited" and "Permitted" under "EnableAuthnTrap". At the bottom are "OK" and "Cancel" buttons.

Clicking [OK] updates the changes.

[SMTP Setting] screen

This screen is used for the SMTP (Simple Mail Transfer Protocol) settings. Perform the settings when using [2:Mail] for [Setting of Count Report] (A 75).

The screenshot shows the "SMTP Setting" dialog box. It includes sections for SMTP Authentication, <Counter Info. Mail-> Send, Use SMTP Authentication, and Send Transmission Result to Administrator. Each section has radio buttons for "Don't send" and "Send". There are also fields for User name, Password, SMTP Server Name, Sender Address, Receiver Address 1, Receiver Address 2, Port No, Subject, Message (Add Comment), Signature, Administrator Address, and another Signature field. At the bottom are "OK" and "Cancel" buttons.

Clicking [OK] updates the changes.



B This screen may not be displayed depending on your system configuration. For more information, consult your dealer or authorized service representative.



Chapter 8

Replacing Consumables

Setting the Master Roll

If a master roll is depleted, a message is displayed and this machine stops. Set a new master roll in place.



It is recommended to use products specified by RISO when replacing the master roll.

Keep the power on while replacing the master roll.



You can watch the procedure in the movie.



<https://www.youtube.com/watch?v=70PuCv4BxQo>

The code may not be able to be read depending on the smartphone or tablet models. In such cases, go to the above URL.

There are expenses such as communication costs when watching the movie.

The movie may be cancelled without notice.

1 Open the front door.

2 Check that the [Master Making Unit Release Button] lamp is lit.

If the lamp is off, press [Master Making Unit Release Button] to light it up.

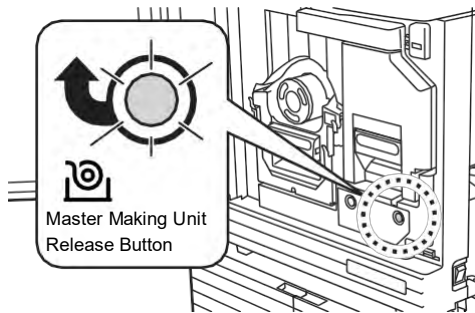

When the print drum (cylinder) is pulled out, you cannot pull out the master making unit. Return the print drum (cylinder) to its original position, and then press [Master Making Unit Release Button].

3 Pull out the master making unit.

1 Grasp the master making unit handle and pull it to the front.

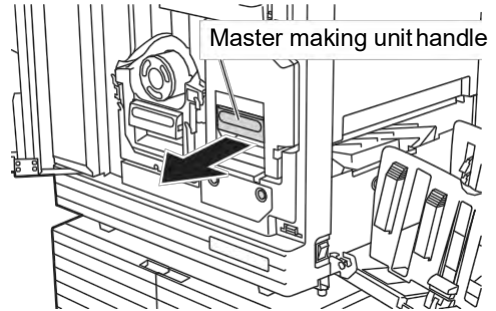

2 Pull out the master making unit slowly as far as it will go.

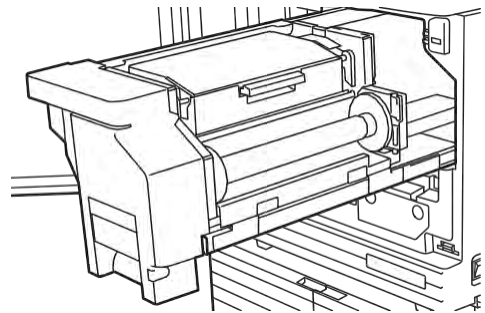

4 Open the master making unit cover.

While grasping the handle, open the master making unit cover.

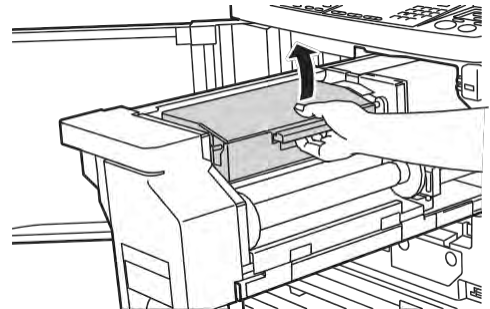

5 Open the master roll holder.

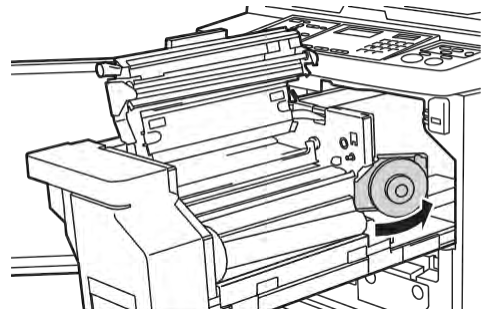

6 Remove the depleted master core.

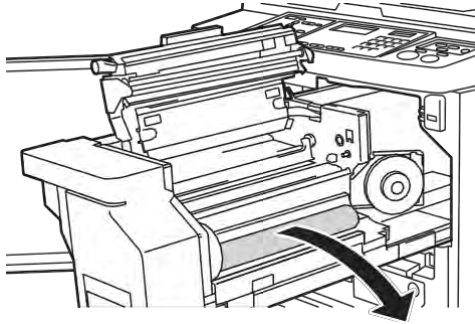

- !** **Dispose of the depleted master core according to the disposal regulations of your local community.** (A 97 “Collecting and Disposing of Depleted Consumables”)
- B** **Clean the thermal print head.** (A 100 “Maintenance”)

7 Set a new master roll.

Remove the package (transparent film) of the master roll. Set the master roll so that the [i] symbol is located on the left.

- !** **Take care not to scratch the [i] section. If the [i] section is bent or cut at a perforation, the master roll will become unusable.**
- B** **Do not remove the tape yet.**

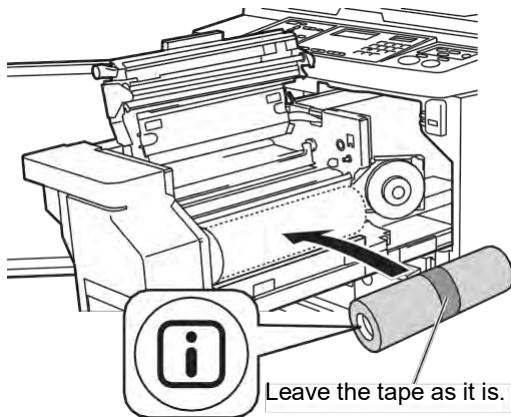

8 Close the master roll holder.

- 1 Close the master roll holder.
- 2 Remove the tape.

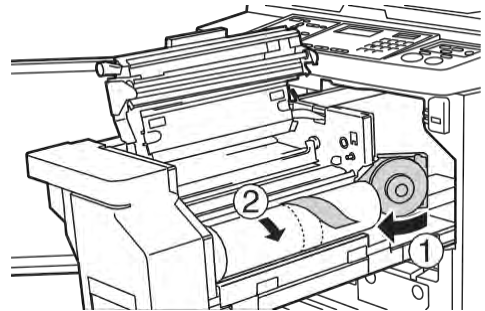

9 Insert the leading edge of the master roll under the master guide flap.

- 1 Insert the leading edge of the master roll under the master guide flap and advance it as far as it will go.
- 2 If the master roll is loose, turn the flange on the right toward the rear and rewind it.

Master guide flap

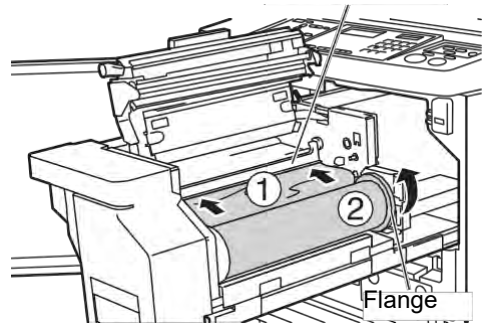

■ If you cannot insert the master roll

Insert the master roll using the following steps.

- 1 Turn the dial at the edge of the master guide flap toward the rear and raise the master guide flap.
- 2 Align the leading edge of the master roll to the line indicated by the arrow.
- 3 Return the master guide flap to its original position.

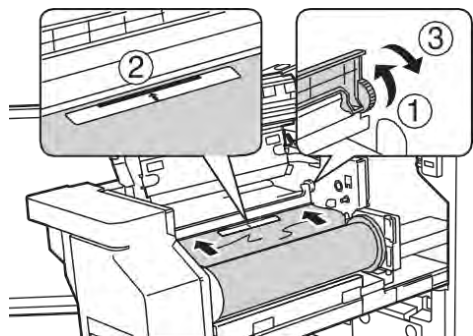

10 Close the master making unit cover.

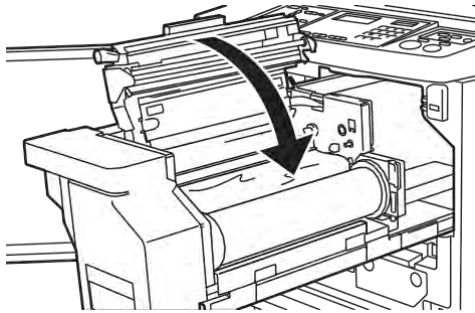

! When closing the master making unit cover, press the cover itself with your hands from above without holding the lever. Make sure to close it so that it does not open when you release your hands.

11 Return the master making unit to its original position.

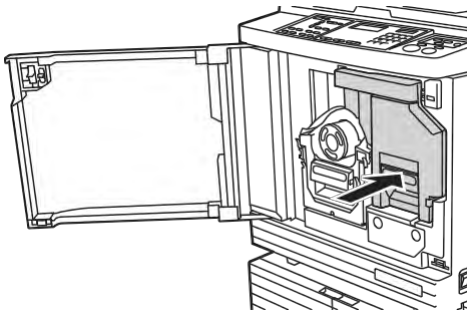

12 Close the front door.

Replacing the Ink Cartridge

When the ink is depleted, a message is displayed and this machine stops. Replace the ink cartridge with a new one.



You can watch the procedure in the movie.



<https://www.youtube.com/watch?v=9WBLunKij04>

The code may not be able to be read depending on the smartphone or tablet models. In such cases, go to the above URL.

There are expenses such as communication costs when watching the movie.

The movie may be cancelled without notice.



Caution

Ink may be left on the area around the print drum (cylinder). Take care not to smudge your hands or clothes with the ink.

Wash immediately with soap if you get ink on your hands, etc.



It is recommended to use products specified by RISO when replacing the ink cartridge.

Keep the power on while replacing the ink cartridge.

Replace with an ink cartridge of the same ink color. If you want to change the ink color, replace the entire print drum (cylinder). (A 95 “Replacing the Print Drum (Cylinder)”)

1 Open the front door.

2 Pull out the depleted ink cartridge.

1 Turn the ink cartridge counterclockwise.

2 Pull out the ink cartridge to the front.

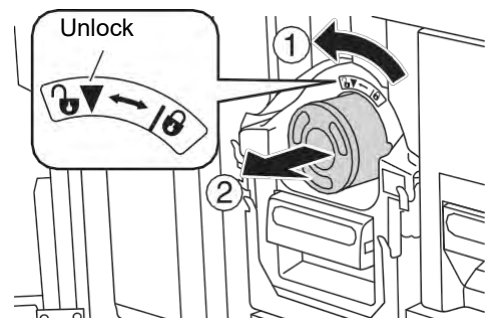

- ! **B** Dispose of the depleted ink cartridge according to the disposal regulations of your local community. (A 97 “Collecting and Disposing of Depleted Consumables”)

3 Remove the cap of the new ink cartridge.

Turn the cap of the ink cartridge to remove it.

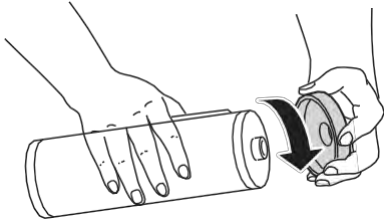

- ! **B** Do not touch or knock the edge of the ink cartridge.
- B** Do not peel off or scratch the label that is attached to the edge of the ink cartridge.

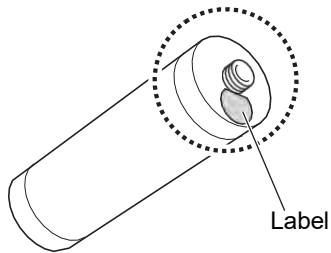

- 4 Set the new ink cartridge in place.**
Align the arrow on the ink cartridge to the [▼] mark on the print drum (cylinder), and then insert the ink cartridge as far as it will go. (Locate the protrusion of the ink cartridge to the right.)

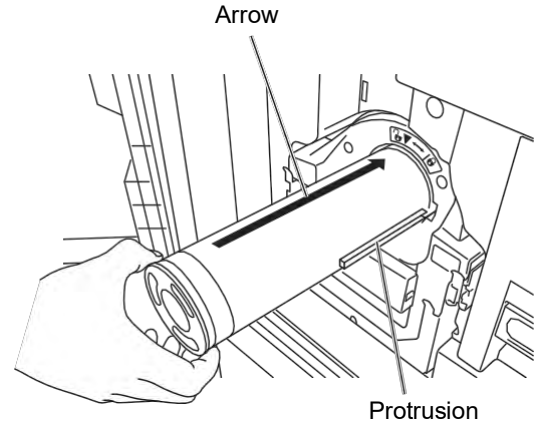

- ! **B** Check the orientation of the ink cartridge carefully when setting it in place. Forcibly pressing it may result in damage.

- 5 Lock the ink cartridge.**
Turn the ink cartridge clockwise to lock it.

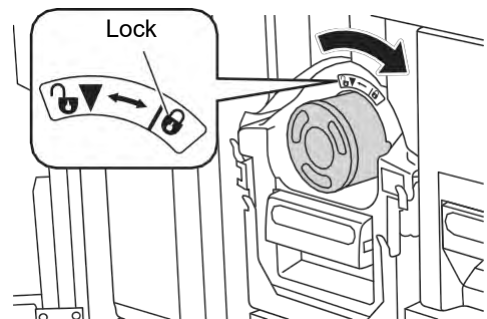

- 6 Close the front door.**

Emptying the Master Disposal Box

Used masters are sent to the master disposal box. When the master disposal box becomes full, a message is displayed and this machine stops. Dispose of the used masters.



B Keep the power on while emptying the master disposal box.



B You can watch the procedure in the movie.



https://www.youtube.com/watch?v=eNyXo__RbmY

C The code may not be able to be read depending on the smartphone or tablet models. In such cases, go to the above URL.

C There are expenses such as communication costs when watching the movie.

C The movie may be cancelled without notice.



Caution

Wash immediately with soap if you get ink on your hands, etc.

1 Unlock the master disposal box.

If the master disposal box is locked, slide the lock lever to the right to unlock it. (This operation is not necessary if the lock handle is not attached.)

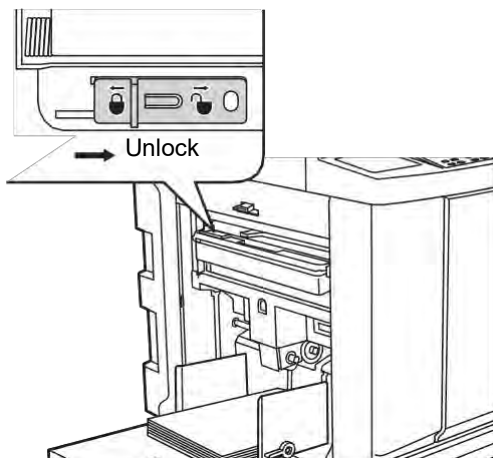

B If a padlock is attached to the master disposal box, contact your administrator and unlock it.

2 Remove the master disposal box.

Pull out the master disposal box horizontally while grasping the master disposal box handle.

Master disposal box

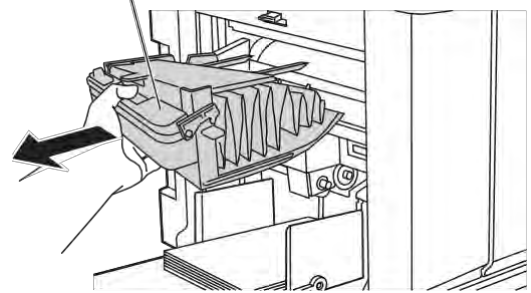

3 Dispose of the used masters.

Tilt the master disposal box to the front above a garbage box. Grasping the push-out handle drops the used masters.

Push-out lever

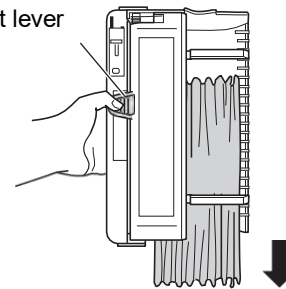

4 Set the master disposal box in place.

Insert the master disposal box as far as it will go.

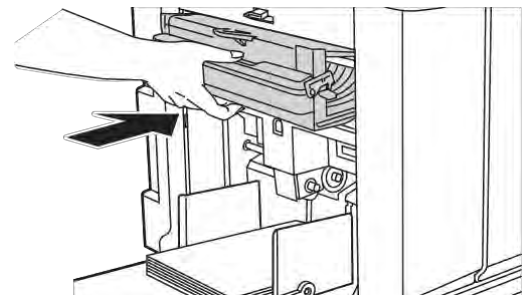

B Dispose of the used masters according to the disposal regulations of your local community. (A 97 “Collecting and Disposing of Depleted Consumables”)

B Normally, you can use the master disposal box while it is unlocked. Slide the lock lever to the left to lock it as necessary.

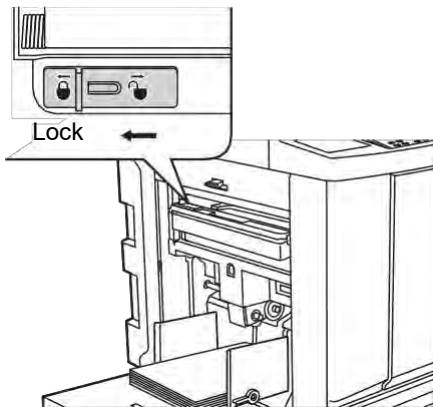

B The master disposal box can be locked with a padlock, etc. When locking, insert the padlock into the lock lever hole as illustrated below. (Purchase a commercially available padlock. The diameter of the hole for inserting the padlock is 7 mm [9/32 inches].)

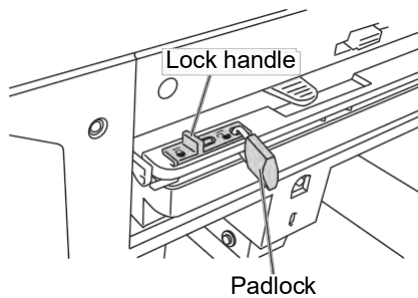

Replacing the Print Drum (Cylinder)

If you want to print in a different color, replace the print drum (cylinder). When you want to remove jammed paper inside this machine, you can also remove the print drum (cylinder).

Caution

- Ink may be left on the area around the print drum (cylinder) or the inside of this machine after the print drum (cylinder) unit has been removed. Take care not to smudge your hands or clothes with the ink. Wash immediately with soap if you get ink on your hands, etc.
- When you put your hands inside the main unit, take care not to touch any protrusions or edges of the metal plate. It may result in injury.
- Do not stand the print drum (cylinder) vertically. Doing so may stain the floor, etc.

! Use the dedicated print drum (cylinder) for this machine.

(A 124 “Optional Accessories”)

B Keep the power on while removing or replacing the print drum (cylinder).

B Store the replaced print drum (cylinder) horizontally in the print drum (cylinder) case.

Removing the print drum (cylinder)

1 Open the front door.

2 Check that the [Print Drum (Cylinder) Release Button] lamp is lit.

If the lamp is off, press [Print Drum (Cylinder) Release Button] to light it up.

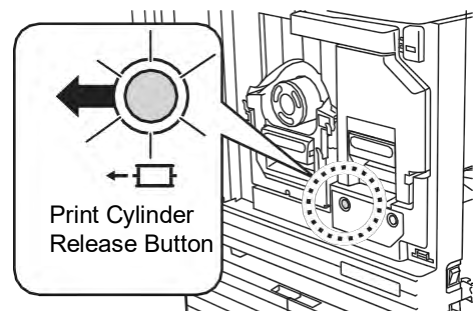



When the master making unit is pulled out, you cannot pull out the print drum (cylinder). Return the master making unit to its original position, and then press [Print Drum (Cylinder) Release Button].

3 Pull out the print drum (cylinder).

Pull out the print drum (cylinder) slowly as far as it will go while grasping the print drum (cylinder) handle.

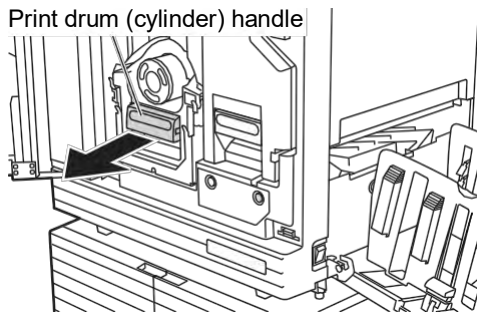

4 Remove the print drum (cylinder).

Use both hands to lift the print drum (cylinder) straight up and remove it from the rail. Firmly grasp the blue handle section.

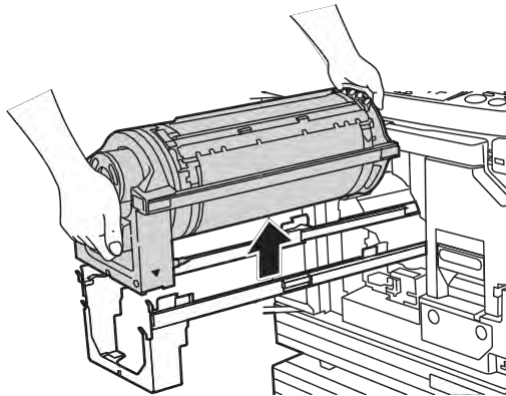

Do not touch the connector on the print drum (cylinder). Neglecting this may result in a malfunction of the print drum (cylinder) because of static electricity or other factors.

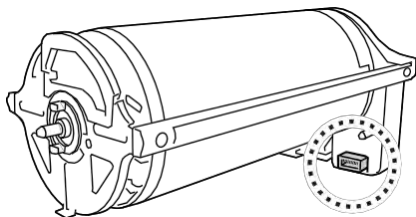

Installing the print drum (cylinder)

1 Place the print drum (cylinder) on the rail.

Align the [▼] mark on the print drum (cylinder) with the [▲] mark on the rail. Place the print drum (cylinder) on the rail horizontally.

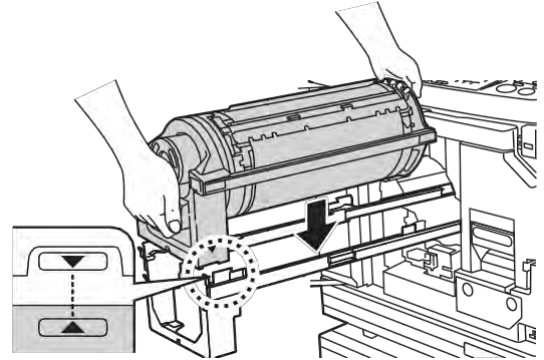

If the print drum (cylinder) was manually rotated, be sure to return it so that the [▼] and [▲] marks align after the procedure is complete.

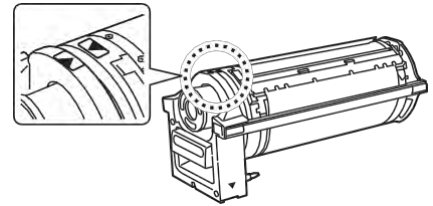

2 Return the print drum (cylinder) to this machine.

Push in the print drum (cylinder) slowly as far as it will go.

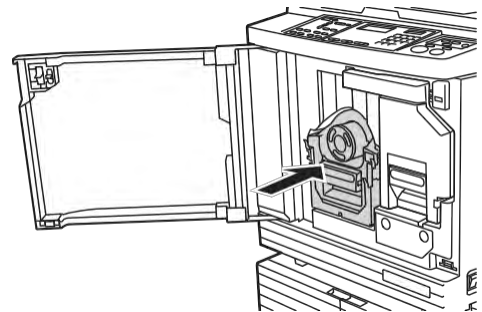

When pushing in the print drum (cylinder), do not grasp the print drum (cylinder) handle.

3 Close the front door.

Collecting and Disposing of Depleted Consumables

Ink cartridge

- Dispose of the depleted ink cartridges according to the disposal regulations of your local community. If required, separate the specific components using the following procedures as a reference.

Parts	Materials
Ink cartridge and cap	Plastic (polypropylene or polyethylene)
Label	Plastic (metal included)
Ink	Plant oil, petroleum hydrocarbons, water, pigments

- Remove the label at the edge of the ink cartridge by peeling it off from the section indicated with the arrow in the illustration below, and then dispose of it separately.

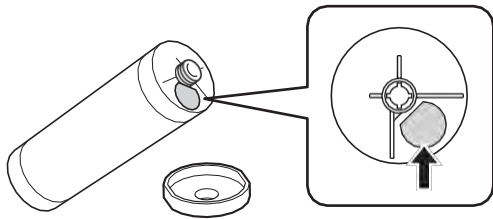

Caution

Ink may be left on the area around the edge of the ink cartridge. Take care not to smudge your hands or clothes with the ink. Wash immediately with soap if you get ink on your hands, etc.

Master core

- Dispose of the depleted master core according to the disposal regulations of your local community. If required, separate the specific components using the following procedures as a reference.

Parts	Materials
Core	Paper
Master roll	Plastic, Japanese paper
Cutout section marked with []	Plastic (metal included), paper

- A label that includes a metallic component is attached to the rear side of the section that is stamped with the [] mark. Tear along the perforation and dispose of it separately.

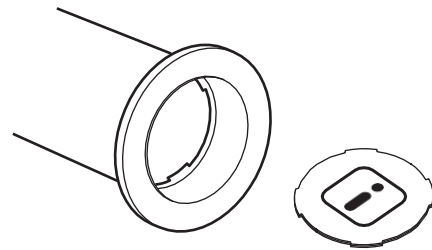

Used master

- Dispose of the used masters according to the disposal regulations of your local community. If required, separate the specific components using the following procedures as a reference.

Parts	Materials
Master roll	Plastic, Japanese paper (ink remains on the master roll)



B The master is made of carbon and hydrogen compounds. If it is fully combusted, it will turn into water and carbon dioxide.



Chapter 9

Maintenance

Maintenance

The finish of prints may be stained or blurred if the thermal print head of the master making unit, parts such as the scanner glass and white sheet of the optional auto document feeder, or other parts are contaminated with dust, dirt, white-out, etc. We recommend that you perform maintenance periodically.



Caution

Do not perform any procedures (adjustment, repair, etc.) that are not described in this guide. When you want to adjust or repair, consult your dealer or authorized service representative.

Thermal print head

The thermal print head is a component that produces heat during master making and forms minute holes on the master. Clean it whenever the master roll is replaced.

Open the master making unit cover, and then gently wipe the thermal print head in the back of the unit several times with a soft cloth, etc.



Caution



Hot surface

Do not directly touch the thermal print head with your fingers. The thermal print head may be heated and cause burns.



B The thermal print head is extremely delicate. Avoid creating excessive impacts or scratches with a hard object.

B The thermal print head is susceptible to static electricity. Be sure to remove the static electricity charge that is accumulated in your body before cleaning.

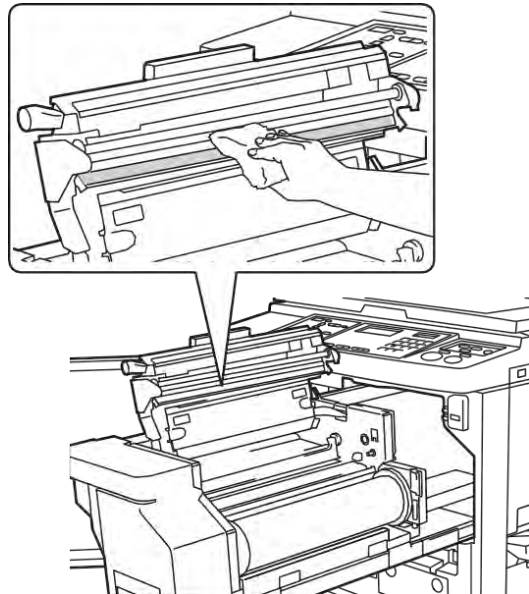

Exterior

Use a soft cloth to gently wipe the entire exterior periodically in order to protect the machine exterior from dust.



B Plastic is used for the machine exterior. Do not use alcohol or solvent for cleaning.

Normally, gently wipe off dirt on the display with a dry cloth. If ink adheres to the touch panel, dampen a cloth with a small amount of cleaner and gently wipe it off.



B Do not coat or spray the cleaner solution directly onto the display. Doing so may result in malfunctions.

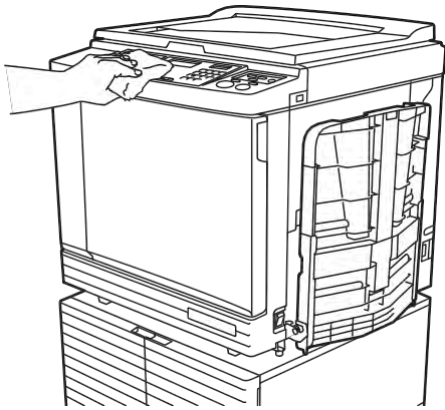

Glass platen and platen cover pad

If the glass platen or platen cover pad is stained, gently wipe it off several times with a soft cloth or tissue paper.



B The glass platen is extremely delicate. Avoid creating excessive impacts or scratches with a hard object.

Glass platen

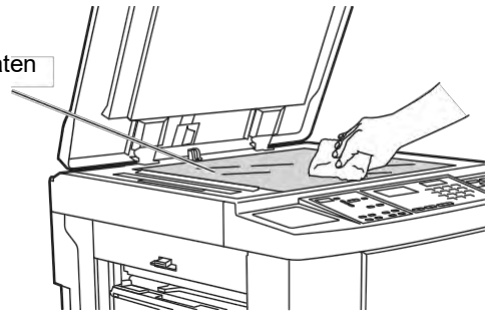

Platen cover pad

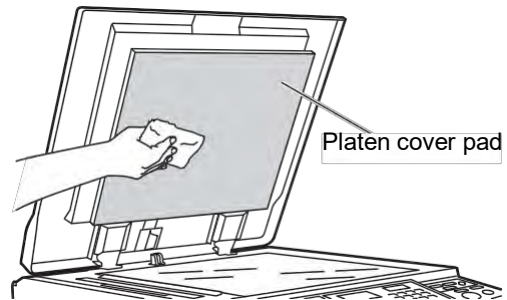

Optional Auto Document Feeder

Gently wipe any stains off the scanner glass and white sheet with a soft cloth or tissue paper.

-  **B The scanner glass is extremely delicate. Avoid creating excessive impacts or scratches with a hard object.**

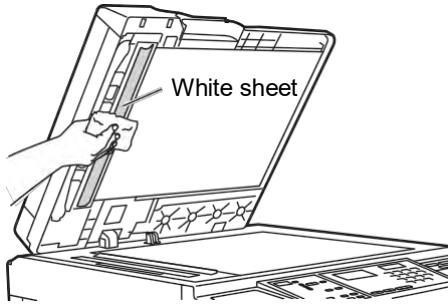
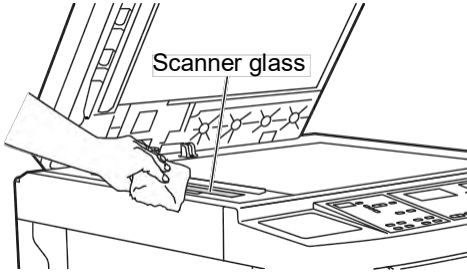

Pressure roller

The pressure roller is a component that presses a paper against the print drum (cylinder) unit. If the pressure roller is stained, smudged strips may appear on the back of papers.

Gently wipe the pressure roller several times with a soft cloth or tissue paper.

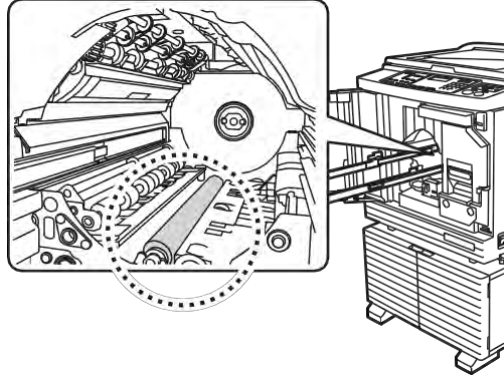

Caution

- Be sure to turn off the power to this machine when cleaning the pressure roller.
- Ink may be left on the inside of this machine after the print drum (cylinder) unit has been removed. Take care not to smudge your hands or clothes with the ink. Wash immediately with soap if you get ink on your hands, etc.
- When you put your hands inside the main unit, take care not to touch the paper separation hook or master removal hooks. The sharp tips of these hooks can hurt your hands.



Master removal hooks

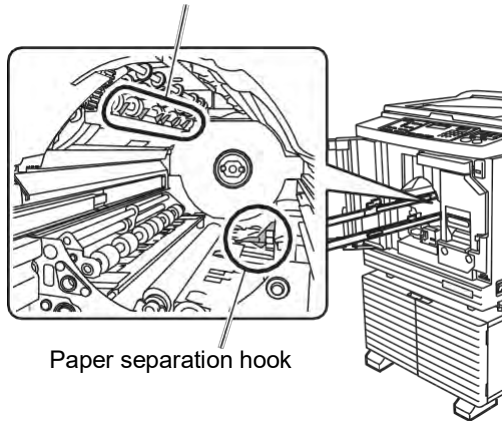

Paper separation hook



Chapter 10

Troubleshooting

When a Message Is Displayed

This section describes the troubleshooting procedure when a message is displayed.



Caution

When you put your hands inside the main unit, take care not to touch any protrusions or edges of the metal plate. It may result in injury.

How to view the message

A troubleshooting procedure is displayed in accordance situation.

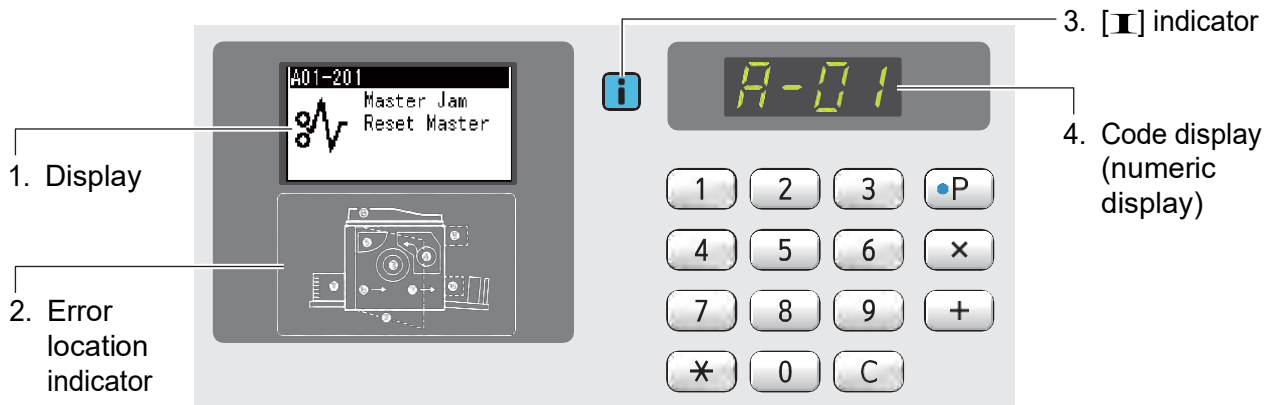

1. Display

The code and message are displayed.

Code ¹	Type	Description
T00-0000 (P00-0000) ²	Service call error	This type of error is displayed when an error that requires inspection and repair by an authorized service representative has occurred. Report the code of the error to your dealer or authorized service representative.
A00-0000	Master jam error	This type of error is displayed when a master is jammed.
B00-0000	Optional accessory error	This type of error is displayed when an error has occurred in any of the optional accessories that are currently connected.
C00-0000	Consumables error	This type of error is displayed when any consumables, such as ink and master rolls, are depleted.
D00-0000	Installation check error	This type of error is displayed when any of the sections is installed incorrectly.
E00-0000	Maintenance call error	This is displayed when battery replacement or periodic inspection by an authorized service representative is necessary. Report the code of the error to your dealer or authorized service representative.
F00-0000 G00-0000	Warning	This is displayed when the setting on the control panel does not conform to the condition of this machine.
J00	Paper jam error	This type of error is displayed when an original or paper is jammed.

¹ For "0" of each code in the above list, the specific number is displayed.



² In the numeric display, "P" is displayed instead of "T".

2. Error location indicator

The lamp of the location at which an error is occurring lights up.

3. [I] indicator

The color of the [I] indicator shows the status of this machine.

Display	Description
 (Blue)	This machine is operating properly.
 (Yellow)	This machine is operating properly, but the function (remaining amount display, etc.) that requires the matching information cannot be activated. A 113 “When the [I] indicator blinks and [H] is displayed in the numeric display”
 (Off)	A 114 “When the [I] indicator goes off and an error code is displayed in the numeric display”

4. Code display (numeric display)

The error or warning code blinks.

Message

Take an action according to the displayed message.

■ T00-0000 (P00-0000): Service call error

To clear the error display, press the [RESET] key. If the error display does not disappear, turn off the power.

Message	Action
Call Service	Consult your dealer or authorized service representative.

■ A00-0000: Master jam error

To clear the error display, take an action and press the [RESET] key.

Location	Code	Message	Action
4 Master making	A01	Master Jam Reset Master	Pull out the master making unit, and then set a master roll in place correctly. (A 90 “Setting the Master Roll”)  If the rewind master roll is wrinkled or cut in a zig-zag manner, cut off the end of the master roll by using a cutter, etc., and then set it in place.
3 Print drum (cylinder)	A02 A04	Master Jam Remove Master	1 Pull out the print drum (cylinder), and then remove the master on the print drum (cylinder). (A 95 “Replacing the Print Drum (Cylinder)”) 2 Set the print drum (cylinder) in place again. 3 Press the [START] key.
5 Master disposal	A05	Master Jam Remove Master	Take out the disposal box, and then remove the jammed master. (A 94 “Emptying the Master Disposal Box”) If the error display does not disappear, consult your dealer or authorized service representative.
1 Master disposal	A06	Check Settings	Check for any obstacles under the paper feed tray or on the paper. If there are any obstacles, remove them.

Location	Code	Message	Action
3 Print drum (cylinder)	A16	Master Remains Remove Master	<ol style="list-style-type: none"> 1 Pull out the print drum (cylinder), and then remove the master on the print drum (cylinder). (A 95 "Replacing the Print Drum (Cylinder)") 2 Set the print drum (cylinder) in place again. 3 Press the [START] key.
4 Master making	A17	Remove Master Close Unit Cover	<p>The cutter that cuts the master roll did not function properly.</p> <ol style="list-style-type: none"> 1 Pull out the master making unit, and then remove the master roll. (A 90 "Setting the Master Roll") 2 Close the master making unit cover to clear the error. 3 Open the master making unit cover again, and then set the master roll in place.
4 Master making	A34	Check Settings	<p>Set the master roll in place correctly. (A 90 "Setting the Master Roll")</p> <p> If the rewind master roll is wrinkled or cut in a zig-zag manner, cut off the end of the master roll by using a cutter, etc., and then set it in place.</p>

■ B00-0000: Optional accessory error

To clear the error display, take an action and press the [RESET] key.

Location	Code	Message	Action
O Job Separator	B22	Check Settings	Turn on the power to the optional Job Separator.
O Job Separator	B23	Check Settings	Set a new tape in the optional Job Separator.
O Job Separator	B24	Check Settings	Check the optional Job Separator and remove any jammed tapes.
-	B29	Can not identify (USB hub)	A USB hub is set in the USB port of this machine. Set a USB flash drive that is usable for this machine. (A 11 "Printing of original data")
-	B30 B38 B39	Can not identify	Set a USB flash drive that is usable for this machine. (A 11 "Printing of original data")
-	B32	Check Settings	Check that the network cable is correctly connected to this machine and that there are no problems with the network.
-	B33	Check Settings	Set the IP address of this machine. (A 68 "Connecting to the Network")

■ C00-0000: Consumables error



To clear the error display, take an action and press the [RESET] key.

Location	Code	Message	Action
3 Print drum (cylinder)	C01	Replace Ink Cartridge	Replace the ink cartridge with a new one. (A 92 "Replacing the Ink Cartridge")
4 Master making	C02	Replace Master Roll	Remove the master core from the master making unit, and then set a new master roll in place. (A 90 "Setting the Master Roll")
5 Master disposal	C03	Empty Disposal Box	Dispose of the masters in the master disposal box. (A 94 "Emptying the Master Disposal Box")
1 Paper feeding	C04	Check Settings	Set paper on the paper feed tray. (A 24 "Setting up the paper feed tray and the paper")
3 Print drum (cylinder)	C11	Expired Ink Replace Ink Cartridge	Replace the ink cartridge with a new one. (A 92 "Replacing the Ink Cartridge")
4 Master making	C12	Expired Master Replace Master Roll	Replace the master roll with a new one. (A 90 "Setting the Master Roll")
3 Print drum (Cylinder) 4 Master making	C13	Expired Ink & Master Replace them	Replace the ink cartridge and the master roll with new ones. (A 92 "Replacing the Ink Cartridge") (A 90 "Setting the Master Roll")

■ D00-0000: Installation error

To clear the error display, take an action and press the [RESET] key.

Location	Code	Message	Action
3 Print drum (cylinder)	D01	Check Settings	The print drum (cylinder) is not set in place or not set correctly. Set the print drum (cylinder) in place correctly. (A 95 "Replacing the Print Drum (Cylinder)")

Location	Code	Message	Action
3 Print drum (cylinder)	D02	Check Settings	Set an appropriate print drum (cylinder) in place. (A 95 "Replacing the Print Drum (Cylinder)")  Use the dedicated print drum (cylinder) for this machine. If other print drums (cylinders) are used, it may result in malfunctions or problems.
3 Print drum (cylinder)	D03	Check Settings	Set the ink cartridge in place correctly. (A 92 "Replacing the Ink Cartridge")
3 Print drum (cylinder)	D04	Check Settings	Check that the type and color of the ink cartridge are appropriate. Set an appropriate ink cartridge in place.  Use the ink cartridge that is recommended by RISO. If other ink cartridges are used, it may result in malfunctions or problems.
			Check if the label at the edge of the ink cartridge has been peeled off or stained. The label at the edge of the ink cartridge contains the necessary information for printing. Set an ink cartridge in place on which an unstained label is properly attached. (A 92 "Replacing the Ink Cartridge")
4 Master making	D05	Check Settings	Set the master roll in place correctly. (A 90 "Setting the Master Roll")
5 Master disposal	D07	Check Settings	The master disposal box is not set in place or not set correctly. Set the master disposal box in place correctly. (A 94 "Emptying the Master Disposal Box")
4 Master making	D08 D09	Check Settings	The master making unit cover is open or is not set correctly. Pull out the master making unit, and then set the cover in place again. (A 90 "Setting the Master Roll")
2 Front door	D11	Check Settings	The front door of this machine is open or is not set correctly. Close the front door again.
-	D13	Call Service	The rear cover of this machine is removed. Consult your dealer or authorized service representative.
4 Master making	D17	Check Settings	Check that the type of master roll is appropriate. Set an appropriate master roll in place.  Use the master roll that is recommended by RISO. If other master rolls are used, it may result in malfunctions or problems.
			Check if the [■] section of the master core is bent or cut. The [■] section of the master core contains the necessary information for printing. Set a master roll in place that contains a [■] section that is not bent or cut. (A 90 "Setting the Master Roll")

Location	Code	Message	Action
2 Front door	D18	Print Drum has been Unlocked	The print drum (cylinder) can be pulled out. Pull out the print drum (cylinder).
2 Front door	D19	Master Making Unit has been Unlocked	The master making unit can be pulled out. Pull out the master making unit.
3 Print drum (cylinder)	D22	Check Settings	The print drum (cylinder) is not set as far as it can go. 1 Press [Print Drum (Cylinder) Release Button] and wait until it lights up. 2 Pull out the print drum (cylinder), and then set it in place again.
8 Scanning	D23	Check Settings	Close the ADF cover of the optional auto document feeder.
3 Print drum (cylinder)	D45	Reinstall Ink Cartridge	The ink cartridge may have not been installed properly. Remove the ink cartridge and set it again. (A 92 "Replacing the Ink Cartridge")

■ E00-0000: Maintenance call error

To clear the error display, press the [RESET] key.

Location	Code	Message	Action
-	E01	Maintenance Call	The internal battery of this machine is almost depleted. Consult your dealer or authorized service representative for battery replacement.
-	E02	Maintenance Call	Consult your dealer or authorized service representative for periodic inspection.

■ F00-0000/G00-0000: Warning

To clear the error display, press the [RESET] key.

Location	Code	Message	Action
3 Print drum (cylinder)	F01	Check Settings	No master is attached to the print drum (cylinder). Perform master making.  If you leave the print drum (cylinder) with no master attached, the print drum (cylinder) will dry, and this situation may result in malfunctions. Be sure to perform master making or [Confidential] (A 56) and load a master on to the print drum (cylinder).
-	F04	Reached to the limit count Please Contact the administrator	The count has reached the upper limit of the preset number of master making processes or number of printed copies. Please contact your administrator. (A 72 "[Limit T/C] [Limit M/C]")
-	F05	Enter Print Quantity Over [nn]	Enter a value that is larger than the displayed value, and then press the [START] key. You can change the setting in [Minimum Print Q'ty] under [Custom Setting Mode] (A 61).

Location	Code	Message	Action
1 7	F28	Check the Paper feed Setting	This screen is displayed when the paper feed setting lever is set to the position of [CARD] while [Paper Quality] (A 60) is set to [Standard]. Check the paper to be used, and then switch the position of the paper feed setting lever (A 24) as necessary. Also, set the adjustment dial for the paper jumping wings to an appropriate position (A 26).
1 Paper feeding	F30	Possible Multiple Paper Feed	If double feeding (the feeding of overlapped sheets of paper) occurs, take the appropriate action by referring to the instructions on the following page. (A 121 "Papers are not smoothly fed from the paper feed tray.") If double feeding did not occur, set [D-Feed Check] (A 64) to [OFF].
8 Scanning	F37	Check Settings	Set an original on the glass platen.
-	F38	It is already registered Please try another	This message is displayed during password registration in [User Registration] (A 70) if the same password is used by another user. Register a different password.
-	F39	Suspension of use Please Contact the administrator	This message is displayed when a user that is set to [Disable] (A 71) attempts the authentication operation.
8 Scanning	F45	Check Settings	Open the platen cover and set the original in place again.
-	F51	INK Near expiration Use or replace soon	In order to use the ink cartridge under optimal conditions, use it within approximately 24 months after its manufacture date.
-	F56	MASTER Near expiration Use or replace soon	In order to use the master roll under optimal conditions, use it within approximately 24 months after its manufacture date.
-	F57	INK&MASTER Near expiration Use or replace soon	In order to use the ink cartridge and the master roll under optimal conditions, use them within approximately 24 months after their manufacture date.
-	F74	High Speed Print is not available now Please wait a moment	[High Speed] is available when the temperature in the print drum (cylinder) is 5°C (41°F) or higher. If the print drum (cylinder) is cool, increase the room temperature or print at speed [5] for a while, and wait until the print drum (cylinder) is sufficiently warm.
-	F96	Due date for ID counter report Please Contact the administrator	Please contact your administrator to announce that the ID counter report day has arrived. BUntil [Count Report Output] (A 74) is executed, a warning screen is displayed whenever the power turns on. If you do not want to perform [Count Report Output] for the current month, perform [Clear Count Error] (A 74).
-	G01	PaperMemoryPrint is Not Available with ADF. Place Original on Glass Platen	Place a paper memory original on the glass platen.

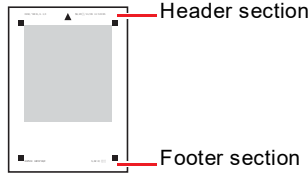
Location	Code	Message	Action
-	G02	Decoding Paper Memory Print failed Check the position of the original	<p>If the Paper Memory Original is not placed straight on the glass platen, it may not be scanned properly. Place the Paper Memory Original again.</p> <p>If the glass platen or platen cover pad is stained, the Paper Memory Original may not be scanned properly. Clean the glass platen and retry scanning the Paper Memory Original. (A 101 "Glass platen and platen cover pad")</p> <p>If the Paper Memory Original is stained, wrinkled, or creased, this machine may not be able to properly scan the Paper Memory Original. We advise that the Paper Memory Original be printed again on a clean sheet of paper.</p> <p>This machine may not be able to properly scan the paper memory original that has been printed using a printer other than those we recommend. We recommend that you print the paper memory original again using a printer that we recommend. For information about printers recommended by RISO, consult your dealer or authorized service representative.</p>
-	G03	Set an appropriate original	<p>Confirm the following information printed on the paper memory original, and place the appropriate paper memory original.</p> <ul style="list-style-type: none"> • Header section: Must match the page number/total number of pages and the conversion date and time that are displayed on the LCD screen. • Footer section: Must match your printer series. 
-	G04	The original is incorrect Set an appropriate original	<p>An original that is not a paper memory original that can be used on this machine is placed. Place the original that has been converted into the paper memory pattern by the printer driver of this machine.</p>
-	G10	Slip Sheet Sorting is Not Available with This Paper Size	<p>When you want to execute [Slip Sheet Sorting] (A 79), place paper of the following size.</p> <p>(Standard sizes) SF5350EII/SF5250EII/SF5330EII/SF5230EII/SF5030EII A3p, B4p, A4p, or Foolscapp SF5450EII/SF5430EII/SF5130EII Ledgerp, Legalp, or Letterp</p> <p>(Custom sizes) 210 mm x 280 mm to 310 mm x 432 mm (8 1/4 inches x 11 1/32 inches to 12 7/32 inches x 17 inches)</p>



J00: Paper jam error

The error location indicator where an original or paper is jammed blinks.



In order to prevent a paper jam, use appropriate papers for printing.
(A 12 "Printing papers")

When placing originals on the optional auto document feeder, use an appropriate original.
(A 12 "Originals")

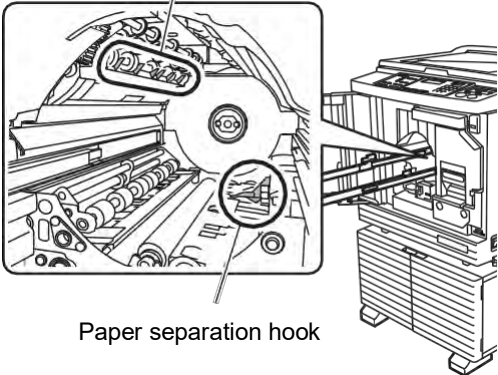
Location	Action
6 Paper feeding side	<p>Check the paper feeding side and lower the paper feed tray, and then remove any jammed papers. If the error display does not disappear, press the [RESET] key.</p> <p> Occasionally, switching the paper feed setting lever can prevent a paper jam. (A 24 "Setting up the paper feed tray and the paper")</p>
8 Optional Auto Document Feeder	<p>Open the ADF cover, and then remove any jammed originals. Depending on the location of the jammed original, you can also remove it from the bottom of the auto document feeder by raising the platen cover.</p>
3 Around the print drum (cylinder)	<p>Pull out the print drum (cylinder), and then remove any jammed papers. (A 95 "Replacing the Print Drum (Cylinder)")</p> <p> Caution</p> <ul style="list-style-type: none"> Ink may be left on the area around the print drum (cylinder) or the inside of this machine after the print drum (cylinder) unit has been removed. Take care not to smudge your hands or clothes with the ink. Wash immediately with soap if you get ink on your hands, etc. When you put your hands inside the main unit, take care not to touch the paper separation hook or master removal hooks. The sharp tips of these hooks can hurt your hands. <div style="text-align: right;">  </div> <div style="text-align: center;"> <p>Master removal hooks _____</p>  <p>Paper separation hook</p> </div>
7 Paper receiving side	<p>Check the paper receiving side and remove any jammed papers.</p>

When the [I] indicator blinks and [H] is displayed in the numeric display

In order to maintain the optimum printing conditions, this machine obtains information from the consumables. If the information cannot be obtained, a code that starts with [H] is displayed in the numeric display. Enter an appropriate value.

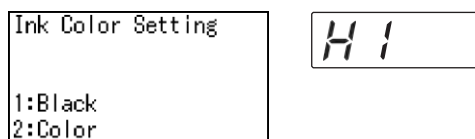

B We assume no responsibility or liability for cases in which you use any consumables other than the consumables recommended by RISO. We are also unable to provide appropriate values for setting. If appropriate values for setting are unknown, we recommend that you adjust by changing values from [1] and on, while checking the print results at the same time.

B If the following operations are performed, the values entered will be erased. In this case, it is necessary to re-enter those values.

CThe power switch is turned off and then on again.

CThe [WAKE-UP] key is pressed while this machine is in sleep mode.

■ [Ink Information Input]

Set the items according to the following table.

No.	Screen display	Description of setting	Value
H1	Ink Color Setting 1: Black 2: Color	Select the same color as the color of the print drum (cylinder) that is currently used. Pressing the [START] key goes to the next step.	1: Black 2: Color
H2	Print Density Fine Adjustment 1 (Light) 5 (Dark)	Enter the setting value to obtain the appropriate print density according to the ink. Pressing the [START] key goes to the next step.	1 (Light) to 5 (Dark)
H3	First Print Density Adjustment 1 (Light) 5 (Dark)	Enter the setting value to obtain the appropriate print density for the first print according to the ink. Pressing the [START] key goes to the next step.	1 (Light) to 5 (Dark)
HE	Enter two digits of month	Enter the month during which the warning [F51] (A 110) will be displayed. Pressing the [START] key goes to the next step.	01 to 12
HY	Enter last two digits of year	Enter the year during which the warning [F51] (A 110) will be displayed. Pressing the [START] key completes the entry of the ink information.	01 to 99

■ [Master Information Input]

Set the items according to the following table.

No.	Screen display	Description of setting	Value
H4	Master-making Density Setting 1 (Light) 10 (Dark)	Enter the setting value to obtain the appropriate master making density according to the master. Pressing the [START] key goes to the next step.	1 (Light) to 10 (Dark)
H5	Print Density Fine Adjustment 1 (Light) 5 (Dark)	Enter the setting value to obtain the appropriate print density according to the master. Pressing the [START] key goes to the next step.	1 (Light) to 5 (Dark)
H6	First Print Density Adjustment 1 (Light) 5 (Dark)	Enter the setting value to obtain the appropriate print density for the first print according to the master. Pressing the [START] key goes to the next step.	1 (Light) to 5 (Dark)
HE	Enter two digits of month	Enter the month during which the warning [F56] (A 110) will be displayed. Pressing the [START] key goes to the next step.	01 to 12
HY	Enter last two digits of year	Enter the year during which the warning [F56] (A 110) will be displayed. Pressing the [START] key completes the entry of the master information.	01 to 99

When the [I] indicator goes off and an error code is displayed in the numeric display

Refer to the following pages and take action according to the code.

Code	Reference page
C01	A 107
C02	A 107
D04	A 108
D17	A 108
Other D error	A 107 to A 109

Troubleshooting

Check the following table and take appropriate measures before consulting your dealer or authorized service representative.



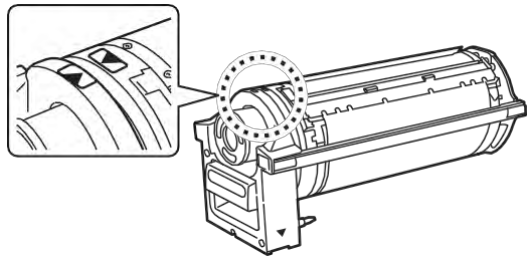

Caution

Do not perform any procedures (adjustment, repair, etc.) that are not described in this guide. When you want to adjust or repair, consult your dealer or authorized service representative.

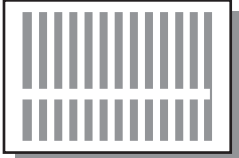
Problem	Point to check	Action
Nothing is displayed on the display even though the power is turned on.	Check if this machine is in sleep mode.	While the [WAKE-UP] key on the control panel is lit, this machine is in sleep mode. Press the [WAKE-UP] key to enable operations of this machine.
This machine does not start up when the power is turned on.	Check if the power is connected.	<ul style="list-style-type: none"> • Check the power cord for proper connection to both this machine and the electrical outlet. • Check if the commercial power breaker has tripped.
The paper feed tray cannot be closed.	Check if the feed-tray paper guides are fully widened.	Turn on the power and lower the paper feed tray to the bottom. Then, raise the lock handles for the feed-tray paper guides, widen the feed-tray paper guides up to the limit, and close the paper feed tray. (A 24 "Setting up the paper feed tray and the paper")
	Check if the power was turned off before the paper feed tray was lowered to the bottom.	
The print drum (cylinder) cannot be placed into position.	Check if the print drum (cylinder) is rotated to the correct stop position.	<p>If the print drum (cylinder) was manually rotated, be sure to return it so that the [▼] and [M] marks align after the procedure is complete.</p> 
	Check if the print drum (cylinder) is set correctly onto the rail.	Set the print drum (cylinder) correctly on the rail. (A 95 "Replacing the Print Drum (Cylinder)")
An error message does not disappear even though an ink cartridge is set in place.	Check if the ink cartridge is set in place correctly.	After inserting the ink cartridge, turn it clockwise to lock it. (A 92 "Replacing the Ink Cartridge")
	Check if the label at the edge of the ink cartridge is scratched or peeled off.	You cannot use an ink cartridge if its label is scratched or peeled off. Set a new ink cartridge in place. (A 92 "Replacing the Ink Cartridge")

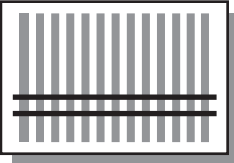
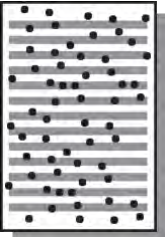
Problem	Point to check	Action
An error message does not disappear even though a master roll is set in place.	Check if the master roll is set in place correctly.	Set the master roll so that the side of the master core with the [] mark is located on the left. (A 90 "Setting the Master Roll")
	Check if the [] section inside the master core is bent or cut.	You cannot use the master roll if its [] section is bent or cut. Set a new master roll in place. (A 90 "Setting the Master Roll")
The master disposal box cannot be set in place.	Check if the lock lever of the master disposal box is locked.	Slide the lock lever (A 94) of the master disposal box to the right to unlock it. Then, set the master disposal box in place.
There is no image on copies.	Check if the original is placed so that it faces up.	Place the original so that it faces down. (A 28 "Placement of Originals")
Closing the platen cover without setting an original automatically switches printing mode to master making mode.	Check if you forcefully closed the platen cover.	If an original is set and detected when the platen cover is closed in printing mode, this machine automatically switches to master making mode. However, forcefully closing the platen cover may cause this machine to incorrectly detect that an original is set even when there is no original. Close the platen cover gently.
A portion of the image is missing on printed papers.	Check if the glass platen is stained.	Wipe the glass platen with a soft cloth, etc. (A 100 "Maintenance")
	Check if any foreign objects are adhered to the master.	Pull out the print drum (cylinder) and check if any foreign object adheres to the master. If there is a foreign object, remove it. If a foreign object exists between the master and the print drum (cylinder), remove the master, and eliminate the foreign object. Then, set the print drum (cylinder) in place and perform the master making process again.
	Check if the paper size that was placed on the paper feed tray for master making is smaller than the size of the original.	The size of the master to be made is determined according to the size of the paper that is placed on the paper feed tray. Set the same size of paper on the paper feed tray as the original, and then perform the master making process.
	Does the size of the image to be printed exceed the maximum printing range of this machine?	The maximum printing area varies depending on the model. (A 14 "Maximum Printing Area") If the original is larger than the maximum printing area, reduce its size to make a master. (A 41 "Enlarging or Reducing the Size of the Original [Size]")
Blank lines are found on printed papers. 	Check if the thermal print head of the master making unit or the scanner glass of the optional auto document feeder is stained.	Wipe the thermal print head or scanner glass with a soft cloth, etc. (A 100 "Maintenance")

Problem	Point to check	Action
<p>Lines are found on printed papers.</p> 	<p>Check if the scanner glass of the optional auto document feeder is stained.</p>	<p>Wipe the scanner glass with a soft cloth, etc. (A 100 "Maintenance")</p>
<p>The overall background of the printed papers is stained.</p> 	<p>Check if colored paper, such as newspaper, is used as the original.</p>	<p>Lighten the contrast in [SCANNING LEVEL] (A 40) and perform master making again.</p>
<p>The edges of printed papers are smudged with ink.</p>	<p>Check if the glass platen is stained.</p>	<p>Wipe the glass platen with a soft cloth, etc. (A 100 "Maintenance")</p>
	<p>Check if the size of the paper that was placed on the paper feed tray for master making is larger than the size of the original.</p>	<p>Set the same size of paper on the paper feed tray as the original, and then perform the master making process.</p>
	<p>Check if the feed-tray paper guides are fitted to the width of the paper during master making.</p>	<p>The size of the master to be made is determined according to the size of the paper (the width of the feed-tray paper guides and the length of the paper) that is placed on the paper feed tray. If the size of the paper placed on the paper feed tray for master making is larger than the size of the original, the outside of the original is also included in master making. For this reason, if the platen cover is not securely closed, the edges of the original may be processed as shadows.</p>
	<p>Check if a corner of a thick paper, such as a postcard, scratches the master when it is being printed.</p>	<p>Perform master making again. Use papers that are suitable for this machine. (A 12 "Printing papers")</p>
	<p>Check if a considerable time elapsed for the master roll that was used after the previous master making.</p>	<p>Perform master making again.</p>

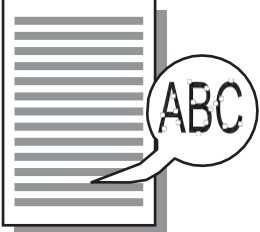
Problem	Point to check	Action
<p>The back of the printed paper is smudged with ink.</p> 	<p>Check if the pressure roller is smudged with ink.</p>	<p>Remove the print drum (cylinder), and then wipe the pressure roller with a soft cloth, etc. (A 100 “Maintenance”) If the print position deviates from the paper, this may cause the pressure roller to be stained with ink. Adjust the print position within the size of the paper.</p>
	<p>Check if the feed-tray paper guides are fitted to the width of the paper during master making.</p>	<p>When performing master making, align the feed-tray paper guides with the width of the paper. (A 24 “Setting up the paper feed tray and the paper”) If the feed-tray paper guides are not aligned with the width of the paper, a master is made in a wider area than the paper size. As a result, ink adheres to the pressure roller outside the paper, and this may cause the ink to be printed on papers.</p>
	<p>Check if a paper that does not efficiently absorb ink is used.</p>	<p>As the next paper is fed before the ink dries, ink adheres to the back of papers. Take the following measures.</p> <ul style="list-style-type: none"> • Use papers that efficiently absorb ink. • Reduce the print speed. [SPEED] (A 46) • Decrease the ink density. [DENSITY] (A 47) [SCANNING LEVEL] (A 40) [INK SAVING] (A 41)
<p>Printed images are faint. Printed text is blurred.</p> 	<p>Check if printing was performed after the print drum (cylinder) was not used for an extended period of time.</p>	<p>If the print drum (cylinder) is not used for an extended period of time, ink on the surface of the print drum (cylinder) may dry. Printing in such a state may result in faint printing for the first few papers just after the printing has started. Press the [PROOF] key and print several papers before starting actual printing. By executing [IDLING] (A 56), high print quality may be instantly achieved from the beginning of printing. This can reduce paper waste.</p>
	<p>Check if the original itself is faint.</p>	<p>Darken the contrast in [SCANNING LEVEL] (A 40) and make a master again. For originals written with a pencil, set [PENCIL] (A 39).</p>
	<p>Check if the temperature is low (below 15°C [59°F]) in the place where this machine is installed or ink cartridges are stored.</p>	<p>Use this machine in a location where the temperature is 15°C (59°F) or higher. For ink cartridges that have been stored in a location at low temperature, keep them in a location at a temperature of 15°C (59°F) or higher before using them. (A 7 “Installation location”)</p>
	<p>Check if [INK SAVING] is set to on.</p>	<p>If a master is made while [INK SAVING] is set to on (A 41), the ink on printed papers is lighter than usual.</p>

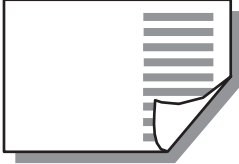
Problem	Point to check	Action
<p>Although [2-UP] was executed, nothing is printed on one side.</p> 	<p>Check if an original was placed while the buzzer was sounding.</p>	<p>If the specified time has elapsed before the second and subsequent originals are placed, master making automatically starts. Any sections that could not be scanned remain as margins. If the time is too short, change [2-Up Mode Scan Waiting Time] (A 60) under [Custom Setting Mode].</p>
	<p>Check if the [STOP] key was pressed while an original was being scanned.</p>	<p>Pressing the [STOP] key while an original is being scanned interrupts scanning. Do not press the [STOP] key until all of the originals are scanned.</p>
<p>The vertical print positions have been shifted.</p>	<p>Check if the vertical print position adjustment dial on the paper feed tray is set to the standard position.</p>	<p>Lower the paper feed tray, and then turn the vertical print position adjustment dial. After adjustment, check the print position on the proof copy. (A 48 "Adjusting the Print Position [PRINT POSITION]")</p>
<p>Papers are loaded on the print drum (cylinder).</p>	<p>Check if the margin at the top of the printed paper is enough.</p>	<p>The margin at the top of the printed paper (leading edge in the paper output direction) must be at least 5 mm (3/16 inches). Lower the horizontal print position, and then print. If it is not possible to lower the print position, reduce the size of the original to allow enough margin and perform master making again. (A 41 "Enlarging or Reducing the Size of the Original [Size]")</p>
	<p>Check if the original has a wide solid portion at its top.</p>	<p>If an original has a wide solid portion at its top, the original is more likely to stick to the print drum (cylinder). Set the original upside down and perform master making again.</p>
	<p>Check if appropriate papers are used.</p>	<p>Use papers that are suitable for this machine. (A 12 "Size and weight")</p>
<p>Curled printed papers are output.</p>	<p>Check if the paper grain (flow of the grain) is aligned with the paper feeding direction.</p>	<p>Place the paper so that its grain is aligned with the paper feeding direction. (A 13 "To prevent paper jams and paper feeding failures")</p>
<p>The printed papers that have been output are not neatly piled up in the paper receiving tray.</p>	<p>Check if the positions of the receiving-tray paper guides and paper stopper are appropriate.</p>	<p>Fit the receiving-tray paper guides and the paper stopper to the paper size. For thick papers, slightly widen them. If you have adjusted the vertical position on the paper feed tray, shift the receiving-tray paper guides in the same direction. (A 25 "Setting up the paper receiving tray")</p>
	<p>Check if the position of the paper-feed setting lever is appropriate.</p>	<p>Select the position of the paper-feed setting lever according to the paper type. (A 24 "Setting up the paper feed tray and the paper")</p>
	<p>Check if the positions of the paper jumping wings are appropriate.</p>	<p>Turn the adjustment dial for the paper jumping wings (A 26) to the position that is relevant to the paper type or size.</p>

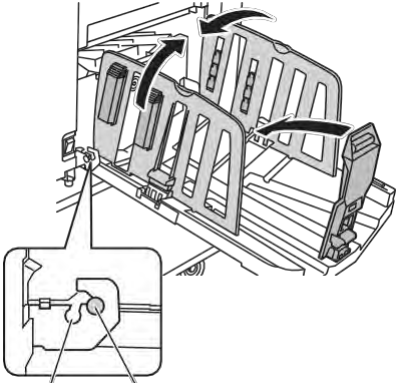
Problem	Point to check	Action
Printed papers go over the paper stopper of the paper receiving tray.	-	<p>Level the paper receiving tray using the following steps.</p> <ol style="list-style-type: none"><li data-bbox="845 309 1388 367">1 Fold the receiving-tray paper guides and the paper stopper.<li data-bbox="845 371 1426 461">2 Lift up the sides of the paper receiving tray with both hands, and then move the paper receiving tray shaft to position B of the bearing.  <p>B: When papers go over the stopper A: Normal position</p>

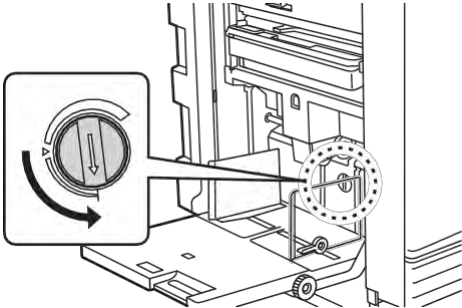
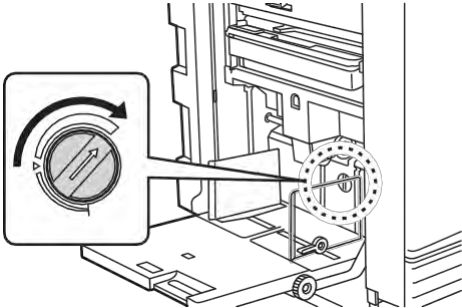
Problem	Point to check	Action
Papers are not smoothly fed from the paper feed tray. (Papers are skipped, or multiple sheets are fed)	Check if appropriate papers are used.	Use papers that are suitable for this machine. (A 12 “Printing papers”)
	Check if the position of the paper feed setting lever is appropriate.	When using thick or slippery papers, switch the paper feed setting lever to the position of [CARD]. (A 24 “Setting up the paper feed tray and the paper”)
	Check if the angle of the stripper plate is appropriate.	<p>Turn the adjustment dial for the stripper plate angle to adjust the angle of the stripper plate in accordance with the paper conditions.</p> <p>! Before the adjustment, be sure to remove any papers from the paper feed tray, and then confirm that the paper feed tray has lowered to the bottom.</p> <p>■ When papers are skipped Turn the dial counterclockwise.</p>  <p>■ When multiple papers are fed Turn the dial clockwise.</p> 
Check if [Paper Quality] is set properly.	Set [Paper Quality] (A 60) as necessary. For more information, consult your dealer or authorized service representative.	
The printed paper is peeling, or the leading edge becomes wrinkled.	Check if the angle of the stripper plate is appropriate.	Turn the adjustment dial for the stripper plate angle (see above illustrations) to adjust the angle of the stripper plate.

Problem	Point to check	Action
An error message is displayed even though there is no paper jam.	Check if a lifted paper has been output.	The margin at the top of the printed paper (leading edge in the paper output direction) must be at least 5 mm (3/16 inches). Lower the horizontal print position, and then print. If it is not possible to lower the print position, reduce the size of the original to allow enough margin and perform master making again. (A 41 “Enlarging or Reducing the Size of the Original [Size]”)
	Check if this machine is exposed to direct sunlight.	The sensor may malfunction if this machine is exposed to direct sunlight. Shield the light using curtains, etc., in order to protect this machine from direct sunlight.
The print speed cannot be set to [High Speed].	Check if printing is performed in a cold location.	[High Speed] is available when the temperature in the print drum (cylinder) is 5°C (41°F) or higher. If the print drum (cylinder) is cool, increase the room temperature or print at speed [5] for a while, and wait until the print drum (cylinder) is sufficiently warm. The [High Speed] function can be used only for the SF5450EII/SF5350EII/SF5250EII.
[Quick Master Making] cannot be used.	Check if a function that cannot be used concurrently with [Quick Master Making] is set.	If you set a function that cannot be used concurrently with [Quick Master Making], [Quick Master Making] (A 62) is disabled.
Original data with multiple pages have been sent from a computer. Even though multiple copies are set for printing, this machine repeats master making one page at a time.	Check if the [Collate] option is selected in the printing dialog box on a computer.	Temporarily delete the original data that this machine has received. To delete the original data, press the [INTERFACE] key (A 30). Deselect [Collate] in the printing dialog box on the computer, and then resend the original data to this machine. (A 30 “Printing from Computer”)
Even though the computer has sent the original data, this machine cannot receive it.	Check if the [INTERFACE] lamp is off on the operation panel.	Press the [INTERFACE] key (A 30) to light up the lamp.
The [START] key is blinking.	Check if the received original data is waiting for output.	Press the [START] key to print them.
Even though the IP address of this machine is set with [1: Manual], it changes to [2: Auto] after restarting.	Check if the entered IP address is the same as that of another device on the network.	Set a unique IP address.



Chapter 11

Appendix

Optional Accessories

A variety of optional accessories are available to enhance the capabilities of this machine. To purchase the optional accessories, consult your dealer or authorized service representative.

■ Auto Document Feeder AF-VII

Feeds up to approximately 50 pages of originals automatically.

■ Color Print Drum (Cylinder)

Enables the print colors to be changed easily simply by replacing a print drum (cylinder). (Dedicated case included)

■ Wide Stacking Tray

A paper receiving tray that is equipped with paper arrangers.

■ IC Card Reader Activation kit RG

Enables individual user management and enhanced security with the use of IC cards.

To use IC card, [Authentication Setting] (A 70) must be configured in [Custom Setting Mode].

■ Job Separator IV;NIII

Enables easy separation of printed papers simply by inserting tape strips when using [Job Separation] function (A 62).

■ RISO Network Kit S10

Required for connecting the following models to the network.

SF5430EII/SF5330EII/SF5230EII/SF5130EII/
SF5030EII

■ Card Feed Kit

A unit for stably feeding paper of the following range of weights.

100g/m² to 400g/m² (27-lb bond to 221-lb index)

■ Envelope Feed Kit

A unit for stably feeding envelopes.

■ RISO Printer Driver for Macintosh

A printer driver to use this machine on Mac OS.

Specifications

■ SF5450EII/SF5350EII/SF5250EII

Model	SF5450EII	SF5350EII	SF5250EII
Master Making Methods	High-speed digital master-making		
Master Making-Time ¹ (When [Quick Master Making] is OFF)	Approx. 19 seconds (Letter paper, short edge feed)	Approx. 20 seconds (A4 paper, short edge feed)	
Master Making-Time ¹ (When [Quick Master Making] is ON)	Approx. 17 seconds (Letter paper, short edge feed)	Approx. 18 seconds (A4 paper, short edge feed)	
Printing Method	Fully automatic printing		
Scanning Resolution	600 dpi × 600 dpi		
Printing Resolution	300 dpi × 600 dpi (perforation on the master ² : 600 dpi × 600 dpi) When [Quick Master Making] is set: 300 dpi × 400 dpi (perforation on the master ² : 600 dpi × 400 dpi)		
Original Type	Book (10 kg [22 lb] or less) or sheet		
Original Paper Weight	When auto document feeder is used: 50 g/m ² to 128 g/m ² (13-lb bond to 34-lb bond) (normal paper)		
Original Size	When glass platen is used: 50 mm × 90 mm to 310 mm × 432 mm (1 31/32 inches × 3 17/32 inches to 12 7/32 inches × 17 inches) When auto document feeder is used: 100 mm × 148 mm to 300 mm × 432 mm (3 15/16 inches × 5 13/16 inches to 11 13/16 inches × 17 inches)		
Maximum Scanning Area	297 mm × 432 mm (11 11/16 inches × 17 inches)		
Print Paper Weight	46 g/m ² to 210 g/m ² (12-lb bond to 116-lb index)		
Print Paper Size	100 mm × 148 mm to 310 mm × 432 mm (3 15/16 inches × 5 13/16 inches to 12 7/32 inches × 17 inches)		
Maximum Printing Area	291 mm × 425 mm (11 15/32 inches × 16 23/32 inches)	291 mm × 413 mm (11 15/32 inches × 16 1/4 inches)	251 mm × 357 mm (9 7/8 inches × 14 1/16 inches)
Paper Feed Tray Stacking Capacity	1000 sheets ³ (stacking height of 110 mm [4 11/32 inches] or lower)		
Paper Receiving Tray Stacking Capacity	1000 sheets ³ (stacking height of 110 mm [4 11/32 inches] or lower)		
Print Speed	6 levels: 60, 80, 100, 120, 130, and 150 (High Speed ⁴) sheets per minute		
Print Position Adjustment	Horizontal: ±15 mm (±19/32 inches) Vertical: ±10 mm (±13/32 inches)		
Image Processing Mode	Line, Photo, Duo, Pencil		

Print Reproduction Ratio	Type: mm Zoom (50% to 200%), 100% reproduction ratio, 3 levels of enlargement (141%, 122%, 116%), 4 levels of reduction (94%, 87%, 82%, 71%) Type: inch Zoom (50% to 200%), 100% reproduction ratio, 3 levels of enlargement (154%, 129%, 121%), 4 levels of reduction (94%, 78%, 65%, 61%)		
User Interface	LCD panel		
Functions	Original Scanning Mode, Scanning Level, Enlargement/Reduction, Dot Process, 2-Up, Book, Ink Saving, Quick Master Making, ADF Semi-Auto ⁵ , Speed, Density, Print Position, Program A/B, D-Feed Check, Slip Sheet Sorting, Job Separation ⁶ , Idling, Confidential, Meter Display, Count Report Output, Proof, Direct Printing, USB Flash-via-Printing, Paper Memory Print, Auto Sleep Setting, Auto Power-OFF Setting, ECO Mode, RISO iQuality System		
Color Change	Print drum (cylinder) replacement method		
Ink Supply	Full automatic (1000 ml/cartridge)		
Master Supply / Disposal	Full automatic (approx. 215 sheets per roll)	Full automatic (approx. 220 sheets per roll)	Full automatic (approx. 250 sheets per roll)
Master Disposal Method	Box type (compatible with vertical disposable type)		
Operating Noise	Max. 65 db (A) (when printing 100 sheets per minute in the operating position)		
Power Source	AC 100-240 V 50-60 Hz <3.4-1.6 A>	SF5350EIII AC 220-240 V 50-60 Hz <1.6 A> SF5350EIIA • For Korea: AC 100-240 V 50-60 Hz <3.4-1.6 A> • For other countries: AC 220 V 60 Hz <1.6 A>	• For Korea: AC 100-240 V 50-60 Hz <3.4-1.6 A> • For other countries: AC 220 V 60 Hz <1.6 A>
Power Consumption	When optional accessories are not connected: Max. 300W (Ready: 20 W or lower, Sleep: 5 W or lower, Power-OFF: 0.5 W or lower) When optional accessories are connected ⁷ :Max. 315W (Ready: 30 W or lower, Sleep: 10 W or lower, Power-OFF: 0.5 W or lower)		
Dimensions (W×D×H)	When in use: 1415 mm × 670 mm ⁸ × 1065 mm ⁹ (55 23/32 inches × 26 3/8 inches ⁸ × 41 15/16 inches ⁹) When in storage: 780 mm × 670 mm ⁸ × 1065 mm ⁹ (30 23/32 inches × 26 3/8 inches ⁸ × 41 15/16 inches ⁹)		
Required Space (W×D×H)	1415 mm × 1240 mm × 1515 mm ⁹ (55 23/32 inches × 48 13/16 inches × 59 21/32 inches ⁹)		
Weight	101 kg (223 lb) ¹⁰		
Safety Information	Indoor type, pollution degree 2, ¹¹ at altitudes of 2000 m or lower		
Optional Accessories	Auto Document Feeder AF-VII, Color Print Drum (Cylinder), Wide Stacking Tray, IC Card Reader Activation kit RG, Job Separator IV;NIII, Card Feed Kit, Envelope Feed Kit, RISO Printer Driver for Macintosh		

¹ Measurement value when set to 100% reproduction ratio.

² The perforation on the master refers to the number of holes made on a master of one-inch square.

³ When using the following weight of paper; 64 g/m² to 80 g/m² (17-lb bond to 21-lb bond)

⁴ If the temperature of the inside of the print drum (cylinder) is less than 5°C (41°F), [High Speed] is not usable.

⁵ Usable when the optional auto document feeder is installed.

⁶ Usable when the optional Job Separator is installed.

⁷ When all the following optional accessories are installed.

- Auto Document Feeder
- Job Separator
- IC Card Reader

⁸ The depth does not include the stabilizers for the dedicated rack.

⁹ The height includes the dedicated rack.

¹⁰ The weight does not include the ink, master roll, and rack.

¹¹ The pollution degree of the usage environment due to dirt and dust in the air. Degree “2” corresponds to a general indoor environment.

■ SF5430EII/SF5330EII/SF5230EII/SF5130EII/SF5030EII

Model	SF5430EII	SF5330EII	SF5230EII	SF5130EII	SF5030EII
Master Making Methods	High-speed digital master-making				
Master Making-Time ¹ (When [Quick Master Making] is OFF)	Approx. 19 seconds (Letter paper, short edge feed)	Approx. 20 seconds (A4 paper, short edge feed)		Approx. 19 seconds (Letter paper, short edge feed)	Approx. 22 seconds (A4 paper, short edge feed)
Master Making-Time ¹ (When [Quick Master Making] is ON)	Approx. 17 seconds (Letter paper, short edge feed)	Approx. 18 seconds (A4 paper, short edge feed)		Approx. 17 seconds (Letter paper, short edge feed)	Approx. 20 seconds (A4 paper, short edge feed)
Printing Method	Fully automatic printing				
Scanning Resolution	600 dpi × 600 dpi				
Printing Resolution	300 dpi × 600 dpi (perforation on the master ² : 600 dpi × 600 dpi) When [Quick Master Making] is set: 300 dpi × 400 dpi (perforation on the master ² : 600 dpi × 400 dpi)				
Original Type	Book (10 kg [22 lb] or less) or sheet				
Original Paper Weight	When auto document feeder is used: 50 g/m ² to 128 g/m ² (13-lb bond to 34-lb bond) (normal paper)				
Original Size	When glass platen is used: 50 mm × 90 mm to 310 mm × 432 mm (1 31/32 inches × 3 17/32 inches to 12 7/32 inches × 17 inches) When auto document feeder is used: 100 mm × 148 mm to 300 mm × 432 mm (3 15/16 inches × 5 13/16 inches to 11 13/16 inches × 17 inches)				
Maximum Scanning Area	297 mm × 432 mm (11 11/16 inches × 17 inches)				
Print Paper Weight	46 g/m ² to 157 g/m ² (12-lb bond to 42-lb bond)				
Print Paper Size	100 mm × 148 mm to 310 mm × 432 mm (3 15/16 inches × 5 13/16 inches to 12 7/32 inches × 17 inches)				
Maximum Printing Area	291mm×425mm (11 15/32 inches × 16 23/32 inches)	291mm×413mm (11 15/32 inches × 16 1/4 inches)	251mm×357mm (9 7/8 inches × 14 1/16 inches)	210mm×357mm (8 1/4 inches × 14 1/16 inches)	210mm×290mm (8 1/4 inches × 11 13/32 inches)
Paper Feed Tray Stacking Capacity	1000 sheets ³ (stacking height of 110 mm [4 11/32 inches] or lower)				
Paper Receiving Tray Stacking Capacity	1000 sheets ³ (stacking height of 110 mm [4 11/32 inches] or lower)				
Print Speed	5 levels: 60, 80, 100, 120, and 130 sheets per minute				
Print Position Adjustment	Horizontal: ±15 mm (±19/32 inches) Vertical: ±10 mm (±13/32 inches)				
Image Processing Mode	Line, Photo, Duo, Pencil				

Print Reproduction Ratio	Type: mm Zoom (50% to 200%), 100% reproduction ratio, 3 levels of enlargement (141%, 122%, 116%), 4 levels of reduction (94%, 87%, 82%, 71%) Type: inch Zoom (50% to 200%), 100% reproduction ratio, 3 levels of enlargement (154%, 129%, 121%), 4 levels of reduction (94%, 78%, 65%, 61%)				
User Interface	LCD panel				
Functions	Original Scanning Mode, Scanning Level, Enlargement/Reduction, Dot Process, 2-Up, Book, Ink Saving, Quick Master Making, ADF Semi-Auto ⁴ , Speed, Density, Print Position, Program A/B, D-Feed Check, Slip Sheet Sorting, Job Separation ⁵ , Idling, Confidential, Meter Display, Count Report Output, Proof, Direct Printing, USB Flash-via-Printing, Paper Memory Print, Auto Sleep Setting, Auto Power-OFF Setting, ECO Mode, RISO iQuality System				
Color Change	Print drum (cylinder) replacement method				
Ink Supply	Full automatic (1000 ml/cartridge)				
Master Supply / Disposal	Full automatic (approx. 215 sheets per roll)	Full automatic (approx. 220 sheets per roll)	Full automatic (approx. 250 sheets per roll)	Full automatic (approx. 295 sheets per roll)	
Master Disposal Method	Box type (compatible with vertical disposable type)				
Power Source ⁶	AC 100-120 V/ AC 220-240 V 50-60 Hz <3.4-1.6 A>	<ul style="list-style-type: none"> • For Korea: AC 220 V 60 Hz <1.6 A> • For Taiwan AC 110 V 60 Hz <3.4 A> • For other countries: AC 220-240 V 50-60 Hz <1.6 A> 	SF5230EIIU AC 100-120 V/ AC 220-240 V 50-60 Hz <3.4-1.6 A> SF5230EIIIE AC 220-240 V 50-60 Hz <1.6 A> SF5230EIIA <ul style="list-style-type: none"> • For Korea: AC 220 V 60 Hz <1.6 A> • For Taiwan AC 110 V 60 Hz <3.4 A> • For other countries: AC 220-240 V 50-60 Hz <1.6 A> 	SF5130EIIU AC 100-120 V/ AC 220-240 V 50-60 Hz <3.4-1.6 A> SF5130EIIIE AC 220-240 V 50-60 Hz <1.6 A>	AC 220-240 V 50-60 Hz <1.6 A>
Power Consumption	When optional accessories are not connected: Max. 300W (Ready: 20 W or lower, Sleep: 5 W or lower, Power-OFF: 0.5 W or lower) When optional accessories are connected ⁷ :Max. 315W (Ready: 30 W or lower, Sleep: 10 W or lower, Power-OFF: 0.5 W or lower)				
Dimensions (W×D×H)	When in use: 1415 mm × 670 mm ⁸ × 1065 mm ⁹ (55 23/32 inches × 26 3/8 inches ⁸ × 41 15/16 inches ⁹) When in storage: 780 mm × 670 mm ⁸ × 1065 mm ⁹ (30 23/32 inches × 26 3/8 inches ⁸ × 41 15/16 inches ⁹)				
Required Space (W×D×H)	1415 mm × 1240 mm × 1515 mm ⁹ (55 23/32 inches × 48 13/16 inches × 59 21/32 inches ⁹)				
Weight	100 kg (221 lb) ¹⁰				
Safety Information	Indoor type, pollution degree 2, ¹¹ at altitudes of 2000 m or lower				

Optional Accessories	Auto Document Feeder AF-VII, Color Print Drum (Cylinder), Wide Stacking Tray, IC Card Reader Activation kit RG, Job Separator IV;NIII, RISO Network Kit S10, Card Feed Kit, Envelope Feed Kit, RISO Printer Driver for Macintosh
----------------------	--

¹ Measurement value when set to 100% reproduction ratio.

² The perforation on the master refers to the number of holes made on a master of one-inch square.

³ When using the following weight of paper; 64 g/m² to 80 g/m² (17-lb bond to 21-lb bond)

⁴ Usable when the optional auto document feeder is installed.

⁵ Usable when the optional Job Separator is installed.

⁶ To switch between 100-120 V and 220-240 V, contact your dealer or authorized representative.

⁷ When all the following optional accessories are installed.

–Auto Document Feeder

– Job Separator

– IC Card Reader

⁸ The depth does not include the stabilizers for the dedicated rack.

⁹ The height includes the dedicated rack.

¹⁰ The weight does not include the ink, master roll, and rack.

¹¹ The pollution degree of the usage environment due to dirt and dust in the air. Degree “2” corresponds to a general indoor environment.

Notes

- The specifications and type of the product are subject to change without prior notice.
- Please note that due to improvements and changes to this machine, some images and explanations in this guide may not correspond to your machine.

Index

Numerics

[U] key.....	19
[+] key.....	19
[V] key.....	19
[I] indicator	19, 105
[1:1].....	41, 42
[1:1] key	41, 42
2-UP	42
[2-UP] key	20
2-Up Mode Scan Waiting Time.....	60
2-Up Print Hold Setting	62

A

ADF cover.....	18
ADF original guides	18
ADF original receiving tray	18
ADF Semi-Auto	61
Adjustment dial for the paper jumping wings	26
Adjustment dial for the stripper plate angle	121
Administrator.....	71
Authentication Function	70
Authentication Method	70
Authentication operation	34
Authentication Setting.....	70
Auto Clear Time	60
Auto Document Feeder	18
Auto Idling time.....	60
Auto Power-OFF	60
Auto process	22, 29, 31, 59
[AUTO PROCESS] key.....	19
Auto Sleep	60

B

Beep Sound	61
BOOK.....	40
Book Gutter Shadow Width.....	59
[BOOK] key	20

C

[C] key	19
---------------	----

Clear Authentication Setting	76
Clear Count Error.....	74
[Clear M/C]	72
[Clear T/C].....	72
[COARSE/FINE] key	20
[CONFIDENTIAL] key	20, 56
Consumables.....	10
Control panel	16
Corrugator	27
Count Report Output.....	74
[CUSTOM] key.....	20
Custom Setting Mode.....	58

D

Density.....	47
[DENSITY] keys.....	19
D-Feed Check.....	64
Disable.....	71
Display	21
Display Density	64
Display Language	64
Displaying the Accumulated Counts.....	77
Dot Process	39
Drum Count.....	77
Duo	39
Duo Mode Setting	63

E

ECO mode.....	64
Error diffusion method	39
Error location indicator	19
Error message	104

F

Feed tray ascent / descent button.....	16
Feed-tray paper guides	16
Front door.....	17

G

[General] tab screen.....	85
General user.....	70

Glass platen	16
Group number	71

H

High Speed	46
Horizontal direction	48

I

IC Card Reader Activation kit RG	124
[IDLING] key	20, 56
Information about consumables	21
Initialize Network	66
Ink cartridge	17
Ink color	21
Ink Information Input	113
[INK SAVING] key	20, 41
[INTERFACE] key	20
IP Address (IPv4)	66, 68
IP Address (IPv6)	66, 69

J

Job Separation	62
----------------------	----

L

LAN port	16
LCD Brightness	64
Limit M/C	72
Limit T/C	72
LINE	38
[LINE/PHOTO]	38, 59
[LINE/PHOTO] key	20
Logging in	84

M

Master disposal box	16
Master guide flap	17
Master Information Input	114
Master making area	14
Master making basic screen	21
[MASTER MAKING] key	19
Master making process	22, 38
Master making unit	17
Master making unit cover	17

Master making unit handle	17
Master Making Unit Release Button	17
Master roll	17
Master roll holder	17
Maximum Printing Area	14
Message area	21
Meter	77
Meter Display	77
Minimum Print Q'ty	61
[Monitoring] Menu	85
Multi-Page Mode	53

N

[Network] Menu	87
[Network setting] screen	87
Numeric display	19
Numeric keys	19

O

Original Book Size	59
Original data display	21
Originals	12

P

[P] key	19
Padlock	95
Paper arranger knob	17
Paper feed setting lever	16
Paper feed tray	16
Paper grain	13
Paper jumping wing	17
Paper Memory Print	65, 79, 81
Paper Quality	60
Paper Receiving Tray	17
Paper stopper	17
Password	84
Pencil	39
[PENCIL] key	20
Photo	38
PIN code	71
Platen cover	16
Platen cover pad	16
Power switch	17

Pressure roller	102
Print basic screen	21
Print Count Hold Setting.....	62
Print density	47, 59
Print drum (cylinder)	17
Print drum (cylinder) handle	17
Print Drum (Cylinder) Release Button.....	17
[PRINT] key.....	19
Print Position.....	48
[PRINT POSITION] keys.....	19
Print Speed	46, 59
[Printer] Menu.....	86
Printing	22
Printing area.....	14
Printing papers	12
Printing process.....	22, 46
Program.....	52
Proof copy.....	22
[PROOF] key.....	19

Q

Quick Master Making.....	62
--------------------------	----

R

Received file.....	21
Receiving-tray paper guides.....	17
Reserve Period.....	61
Reset Counter	73
[RESET] key	19
Reset to Default Setting	67
RISO Console.....	84
RISO Printer Driver.....	11
RISO Utility Software.....	11

S

Scanning Level.....	40, 59
Screen printing method.....	22
Separation Fan.....	63
Set Date.....	73
Single Page Mode	52
Size	41
Slip Sheet Sorting.....	64, 79
[SMTP Setting] screen	87

[SNMP Setting] screen	87
Special Paper Control	78
Speed.....	46
[SPEED] keys	19
Stabilizer	17
Standard ratio.....	41
[START] key	19
[STOP] key	19
Suction Fan	63
[System] tab screen	85

T

Thermal print head.....	17
Top.....	12, 13
Total Master Count Display	77
Total Print Count Display.....	77

U

USB flash drive.....	11, 32
USB port.....	16, 17
User name.....	84
User Registration	70
[User] tab screen.....	85

V

Vertical direction	48
Vertical print position adjustment dial	16, 48

W

[WAKE-UP] key	19
---------------------	----

Z

Zoom.....	42
-----------	----

Notice for Republic of India

RISO complies with the e-waste (Management and Handling) Rules “e-waste Rules”.

What is the “e-waste Rules”?

The purpose of the “e-waste Rule” is to reduce waste and ensure Electrical Equipment is recycled at the end of life.

RISO declares our products comply with the “India E-waste Rule” and prohibits use of lead, mercury, hexavalent chromium, polybrominated biphenyls or polybrominated diphenyl ethers at or over a concentration of 0.1% by weight or at or over 0.01% by weight for cadmium, except for the exemptions set in Schedule 2 of the Rule.

You can't dispose of our used products as household waste. Used products contain many hazardous substances which may have a serious, detrimental effect on the environment and/or human health.

What does the crossed out wheeled bin symbol mean?

The crossed wheeled bin symbol indicates this product must be disposed of separately to household waste.



“e-waste Rules” shall apply to products including their components, consumables, parts and spares needed to function properly.

Who should I contact if I want more information about the “e-waste Rules”?

You should contact Riso India Pvt.Ltd.

Email: product-recycling@risoindia.com ; Tel : 0120-4721300

Notice for European Union Member States

RISO, the environment and the Waste Electrical and Electronic Equipment Directive "WEEE Directive"

What is the WEEE Directive?

The purpose of the WEEE Directive is to reduce waste and ensure Electrical and Electronic Equipment is recycled at the end of its useful life.



What does the crossed out wheeled bin symbol mean?

The crossed out wheeled bin symbol indicates this product must be disposed of separately to normal waste.

Please contact your RISO service agent for information about disposal.

What does the solid bar symbol mean?

The solid bar under the crossed out wheeled bin indicates this product was put on the market after the 13th August 2005.

Who should I contact if I want more information about the WEEE Directive?

You should contact your local RISO service agent for more information.



Please contact the following for supplies and service: