



RISO SF **EII** Series

User's Guide

SF 9450 **EII**

SF 9350 **EII**

SF 9250 **EII**

About This Machine	1
Basic Operations	2
Functions for Master Making	3
Functions for Printing	4
Useful Functions	5
Functions for Scanning	6
Setting the Operation Conditions	7
RISO Console	8
Replacing Consumables	9
Maintenance	10
Troubleshooting	11
Appendix	12

The “Basic Guide”, which supports the Read Out Loud feature in Adobe Acrobat Reader, is stored in the attached “RISO Printer Driver & User Guides” DVD-ROM. It contains excerpts from the User's Guide (this guide) explaining the basic operations for printing using paper originals.

Directory:
\\UsersGuide_Printer\RISO SF9x50EII\English\
BasicGuide_RISO SF9x50EII_ENG.pdf

Recommended operating environment for Read Out Loud:
– Windows 10
– Adobe Acrobat Reader DC



As an **ENERGY STAR**[®] Partner, RISO KAGAKU CORP. has determined that this product meets the **ENERGY STAR**[®] guidelines for energy efficiency.

The International ENERGY STAR Program is an international energy-saving program implemented in the United States, Canada, Japan, EFTA, Switzerland, and Taiwan.

For SF9450EIIU

Duplicator Model: SF9450EIIU

RFID System Model: 050-34901

Contains FCC ID: RPARFR6

This device complies with Part 15 of the FCC Rules. Operation is subject to the following two conditions: (1) this device may not cause harmful interference, and (2) this device must accept any interference received, including interference that may cause undesired operation.

The user is cautioned that unauthorized changes or modifications not approved could void the user's authority to operate the equipment.

NOTE: This equipment has been tested and found to comply with the limits for a Class B digital device, pursuant to part 15 of the FCC Rules. These limits are designed to provide reasonable protection against harmful interference in a residential installation. This equipment generates, uses and can radiate radio frequency energy and, if not installed and used in accordance with the instructions, may cause harmful interference to radio communications. However, there is no guarantee that interference will not occur in a particular installation. If this equipment does cause harmful interference to radio or television reception, which can be determined by turning the equipment off and on, the user is encouraged to try to correct the interference by one or more of the following measures:

- Reorient or relocate the receiving antenna.
- Increase the separation between the equipment and receiver.
- Connect the equipment into an outlet on a circuit different from that to which the receiver is connected.
- Consult the dealer or an experienced radio/TV technician for help.

Contains IC: 4819A-RFR6

Operation is subject to the following two conditions: (1) this device may not cause interference, and (2) this device must accept any interference, including interference that may cause undesired operation of the device.

CAN ICES-3(B)/NMB-3(B)

Perchlorate Material-special handling may apply, See www.dtsc.ca.gov/hazardouswaste/perchlorate
This product may contain certain substances which are restricted when disposed.
Therefore, be sure to consult your contracted service dealer.

For SF9350EIIIE

This product contains RFID (Radio Frequency Identification) System.



RE directive Class1 device

Nur SF9350EIIIE

MASCHINENLÄRMINFORMATION

Maschinenlärminformations-Verordnung 3. GSGV:

Der höchste Schalldruckpegel beträgt 70 dB(A) oder weniger gemäß EN ISO 7779.

Hinweis:

Das Gerät ist nicht für die Benutzung am Bildschirmarbeitsplatz gemäss BildscharbV vorgesehen.

RISO KAGAKU CORPORATION LONDON OFFICE

610 Centennial Park, Centennial Avenue, Elstree, Herts, WD6 3TJ U.K.

For SF9350EIIA and SF9250EIIA

Warning

This is a Class A product. In a domestic environment this product may cause radio interference in which case the user may be required to take adequate measures.

Preface

Thank you for your purchase of this printing machine.

This machine is a digital duplicator that enables clear printing by using simple operations as if you are operating a copying machine.

In addition to the basic functions of scanning and printing paper originals, there are other various functions, such as printing from a computer and utilizing scanned original data.

■ Descriptive contents in this guide

- The reproduction of this guide in whole or in part is strictly prohibited without the permission of RISO KAGAKU CORPORATION.
- The contents of this guide are subject to change in the future without prior notice for improvement of the product.
- Please note that we do not assume any responsibility for the effect of outcomes resulting from the use of this guide and the operation of this machine.

■ Trademarks

- , **RISO** and **RISO iQualitySystem** are trademarks or registered trademarks of RISO KAGAKU CORPORATION in the United States and other countries.
- Microsoft and Windows are either registered trademarks or trademarks of Microsoft Corporation in the United States and/or other countries.
- SD and SDHC logos are trademarks of SD-3C, LLC.
- Other corporate names and/or trademarks are either registered trademarks or trademarks of each company, respectively.



This machine is certified for being manufactured in consideration of Color Universal Design, which improves visibility for more people regardless of individual differences in color perception, by the Color Universal Design Organization (CUDO).

About the User's Guides

User's guides provided for this machine

This machine comes with the following user's guides.

Thoroughly read these user's guides before using this machine.

In addition, read them whenever necessary in case there is anything unclear during the use of this machine. We hope that you will continuously use these guides together with this machine.

■ RISO SF EII Series User's Guide (this guide)

This user's guide explains the basic operation procedures of this machine and also explains how to use advanced printing functions and other useful functions.

It also explains precautions for use, how to handle and replace consumables, and troubleshooting procedures for cases in which a problem occurs.

■ RISO SF EII Series Basic Guide (Read Out Loud)

This guide is included as a PDF file on the attached "RISO Printer Driver & User Guides" DVD-ROM.

It contains excerpts from the User's Guide (this guide) explaining the basic operations for printing using paper originals. It supports the Read Out Loud feature in Adobe Acrobat Reader.

Directory:

\\UsersGuide_Printer\RISO SF9x50EII\English\BasicGuide_RISO SF9x50EII_ENG.pdf

Recommended operating environment for Read Out Loud:

- Windows 10
- Adobe Acrobat Reader DC

■ RISO Printer Driver User's Guide

This user's guide is included as a PDF file on the attached DVD-ROM.

It explains the operation procedures for printing on this machine from a computer and various settings.

■ RISO Utility Software User's Guide

This user's guide is included as a PDF file on the attached CD-ROM.

It explains how to use the RISO COPY COUNT VIEWER and RISO USB PRINT MANAGER.

■ RISO Editor User's Guide

This user's guide explains how to use the [Editor] function.

About symbols



Warnings or precautions for ensuring safety.



Important matters that require special attention. Read carefully and follow the instructions.



Supplemental explanation that provides useful information.



Indicates reference pages.

About screens and illustrations

The screens and illustrations provided in this guide may vary depending on usage environment factors such as the model and installation conditions of optional parts.

Contents

Preface	1
About the User's Guides	2
User's guides provided for this machine.....	2
About symbols.....	2
About screens and illustrations.....	2
Contents	3
Safety Precautions	9
Warning indications	9
Installation location	9
Power connection.....	9
Ground connection	9
Machine handling	10
Ink	10
Locations of caution labels	11
Before Starting Use	11
Precautions for installation.....	11
Precautions for use.....	12
Consumables	12
Printing of original data	13
Software.....	13
Originals.....	14
Printing papers	14
Printing area.....	16
Materials not to be printed.....	16

Chapter 1 About This Machine

Name and Function of Each Part	18
Paper feeding side.....	18
Paper receiving side	19
Option	20
Control panel.....	21
Touch Panel Displays	22
[HOME] screen.....	22
Authentication screen	22
Master making basic screen.....	22
Print basic screen	23
Scan basic screen	24
[Rename] screen	24
Printing Flow	25
"Master making process" and "Printing process"	25
What is [Auto Process]?.....	25

Chapter 2 Basic Operations

Preparation before Printing	28
Setting up the paper feed tray and the paper	28
Setting up the paper receiving tray	29

Placement of Originals	31
When using the glass platen	32
When using the auto document feeder	32
Printing of Paper Originals	33
Printing from Computer	34
When [Auto Process] is set to other than [ON]	35
When [ID print] is set	37
Saving Paper Original as Data	38
Installing a memory card	38
Removing the memory card	39
Scanning the paper originals	39
Printing the Saved Original Data	40
Printing from [Storage]	40
Printing from [USB Job List]	41
Printing from [USB print (Auto process)]	42
How to print the ID data	43
Performing authentication before using this machine	43
Performing authentication operation	43
Releasing the authentication status	44

Chapter 3 Functions for Master Making

Functions for Master Making	46
Image Processing That Is Suitable for the Original [Image]	47
Selecting a Method to Process the Gradation of Photos [Dot Process]	49
Adjusting the Darkness and Lightness of Photos [Contrast Adj]	49
Adjusting the Gradation of Photos [Tone Curve]	50
Adjusting the Contrast of the Original [Contrast]	50
Using a Book Type Original [Book Shadow]	51
Saving Ink [Ink Saving]	52
Shortening the Master Making Time [Quick Master Making]	53
Enlarging or Reducing the Size of the Original [Size]	53
[Standard ratio]	53
[Free]	54
[Zoom]	54
Using Custom Size Paper [Paper Size]	55
Minimizing Margins [Max. Scan]	56
Laying Out Multiple Originals on a Single Sheet of Paper [Multi-Up Print]	56
[Single-Original], [Multiple-Original]	57
[Multi-Up Tickets]	58
One-Touch Operation for 2-Up Printing [2 Up]	60
Cutting the Top Section of the Original [Top Margin Adj.]	61
Adjusting the Master Making Position [Binding Margin Adj.]	62
Checking the Original Data Image [Preview]	63

Operation procedure in the [Preview] screen	63
Checking a Proof Copy of Each Page [ADF Semi-Auto]	64
Using Paper Memory Original [Paper Memory Print]	64
Managing the Saved Original Data [Storage], [USB Job List].....	66
Changing the display style of the list.....	66
Deleting original data.....	67
Details of original data	67
Changing to the [USB Job List] screen	68
Overlaying Original Data on a Paper Original [Overlay].....	68

Chapter 4 Functions for Printing

Functions for Printing.....	72
Adjusting the Print Speed [SPEED]	72
Adjusting the Print Density [DENSITY]	73
Adjusting the Print Position [PRINT POSITION].....	74
Adjusting the position in the horizontal direction.....	74
Adjusting the position in the vertical direction.....	74
Reducing Offset of Ink [Interval]	76
Making a Master Again [Renew Page].....	76
Making a Master Again Automatically [Auto Page Renewal]	77
Adjusting Paper Feeding and Receiving Conditions [Special Paper Ctrl].....	77
Paper feeding adjustment for special paper.....	77
Paper receiving adjustment for special paper.....	78
Registering the adjustment values.....	78
Retrieving the adjustment values.....	79
Changing the adjustment value settings	79
Changing the name of adjustment values	80
Erasing the adjustment values	80
Adjusting the Position of Paper Jumping Wings [Jump Wing Control]	81
Monitoring the Feeding State [D-Feed Check].....	81

Chapter 5 Useful Functions

Useful Functions.....	84
Printing the Sorted Originals [Program]	84
Setting [Single Page Mode].....	85
Setting [Multi-Page Mode].....	86
Canceling [Program]	86
Registering [Program].....	86
Retrieving [Program].....	87
Changing the settings of [Program]	87
Changing the name of [Program].....	88
Erasing [Program].....	88
Inserting Slip Sheet [Slip sheet sorting]	89
Using the Job Separator [Job Separation].....	89

Using the Registered Settings [Job Memory]	90
Registering [Job Memory]	90
Retrieving [Job Memory]	90
Changing the name of [Job Memory]	91
Erasing [Job Memory].....	91
Extending the Reserve Period [Reservation]	92
Preventing Blurring of Ink [Idling Action]	92
Preventing Copying of Confidential Documents [Confidential]	93
Registering Frequently Used Functions for Each User [My Direct Access]	94
Displaying the Accumulated Counts [Meter Display]	95
Calculating the Total Number of Copies [ID Counter Report]	96
Performing [Report Output]	96
Setting the notification day for total count output	97
Sending E-Mails of [ID Counter Report]	98
Presetting.....	98
Sending e-mail	99
Sending E-Mails of the Operation History [Service Info. Mail]	100
Presetting.....	100
Sending e-mail	101

Chapter 6 Functions for Scanning

Functions for Scanning	104
Setting the Name of the Original Data to be Displayed [File Name]	105
Setting the Directory of the Original Data [Directory]	105
Setting the Name of the Person Who Saves the Original Data [Owner]	106
Setting [Owner].....	106
Changing the owner name	107
Setting the Saving Size of the Original Data [Format]	107

Chapter 7 Setting the Operation Conditions

Setting the Operation Conditions [Admin.]	110
Displaying the [Admin.] screen	110
Exiting the [Admin.] screen	110
List of setting items	111
Registering Frequently Used Functions in the [Basic] Tab Screen [DirectAccess Entry]	117
Registering Frequently Used Functions in the [Selections] Tab Screen [Selections Entry]	118
Registering the Custom Size Paper [Custom Paper Entry]	119
Registering the paper size.....	119
Changing the paper size	119
Changing the name of the paper size	120
Erasing the paper size	120
Connecting to the Network [Network Settings (IPv4)] [Network Settings (IPv6)]	121
When connecting to the IPv4 network.....	121
When connecting to the IPv6 network.....	121

Identifying the User [User Management]	122
[Recognized by].....	122
[Management Level]	123
[Create User].....	124
Changing the User Information.....	126
Erasing the General Users.....	126
Changing the group name.....	127
Clearing the Counter for All Users	127
Erasing the Authentication Setting.....	127
Managing the Used Master [Protect]	128
Setting [Protect].....	128
Canceling [Protect]	128

Chapter 8 RISO Console

RISO Console	130
Accessing RISO Console.....	130
Logging in	130
Logging out	130
[Monitoring] Menu	131
[General] tab screen	131
[System] tab screen.....	131
[User] tab screen	131
[Printer] Menu	132
[Active] tab screen	132
[Storage] tab screen	132
[Folder] tab screen.....	133
[Network] Menu	133
[Network setting] screen	133
[SNMP Setting] screen.....	134
[SMTP Setting] screen.....	134

Chapter 9 Replacing Consumables

Checking the Remaining Amount of Consumables	136
Setting the Master Roll	137
Replacing the Ink Cartridge	140
Emptying the Master Disposal Box	141
Replacing the Print Drum (Cylinder)	143
Removing the print drum (cylinder).....	143
Installing the print drum (cylinder).....	144
Collecting and Disposing of Depleted Consumables	145
Ink cartridge	145
Master core	145
Used master.....	145

Chapter 10 Maintenance

Maintenance	148
Thermal print head	148

Exterior	149
Glass platen and platen cover pad.....	149
Optional Auto Document Feeder	150
Pressure roller	150

Chapter 11 Troubleshooting

When a Message Is Displayed.....	152
How to view the message	152
Example of message	153
When the [Consumables Information Input Wizard] screen is displayed.....	159
Troubleshooting	163

Chapter 12 Appendix



Optional Accessories	172
Specifications	173
Index.....	176

Safety Precautions





This section describes the information that you need to be aware of before using this machine. Read this section before operating this machine.

Warning indications

The following warning indications are used to ensure proper operation of this machine and also to prevent hazards to the human body and damage to property.

 Warning	Indicates that incorrect handling by ignoring this symbol may cause death or serious human injury.
 Caution	Indicates that incorrect handling by ignoring this symbol may cause human injury or damage to properties.

Example of pictorial indication

	The  symbol indicates prohibited actions. The specific actions that are prohibited are indicated within the pictograph or in an adjacent area. The pictograph shown on the left indicates prohibition of disassembly.
	The  symbol indicates mandatory actions or instructions. The specific instructions are indicated within the pictograph. The pictograph shown on the left asks you to unplug the power cord.



Installation location

Caution

- Do not place this machine on an unstable location, such as a wobbly base or tilted surface. If this machine falls down or falls over, the situation may result in injury.
- Keep this machine away from humid and dusty environments. Failure to do so may result in fire or electric shock.

Power connection

Warning

- Use this machine in accordance with the rated voltage value. Also, use this machine by connecting it to an electrical outlet with a capacity larger than the rated current value. For the rated voltage and rated current values, check the item of "Power Source" in the table of specifications at the end of this guide.
- Do not use a branching outlet or multiple outlet extension plug. It may result in fire or electric shock. 
- Do not scratch, damage, or process the power cord. Do not damage the power cord by placing heavy objects on it or pulling or forcibly bending it. It may result in fire or electric shock. 
- The provided power cord is dedicated for this machine. Do not use it for other electrical products. It may result in fire or electric shock.
- Do not plug or unplug the power cord with wet hands. It may result in electric shock.

Caution

- When unplugging, do not pull the power cord (be sure to hold the plug). It could damage the cord, and this may result in fire or electric shock.
- If this machine is not used for a long time due to consecutive holidays, etc., be sure to unplug the power cord to ensure safety.
- Unplug the power cord at least once a year and clean the prongs of the plug and their surroundings. Dust collected on these areas may result in fire.



Ground connection

Warning

- Be sure to insert the power plug with a ground conductor into the wall outlet with a ground receptacle.  Do not use the machine if it is not grounded. It may result in fire or electric shock.

Machine handling

Warning

- Do not place a container that is filled with water or metallic objects on this machine. If the water spills or the water or metallic objects fall into this machine, it may result in fire or electric shock.
- Do not use combustible spray and flammable solvent near this machine. If the sprayed gas or flammable solvent contacts the electrical parts inside the mechanical system, it may result in fire or electric shock.
- Do not insert or drop foreign matter, such as metallic parts or highly combustible matter, into this machine through any opening. It may result in fire or electric shock.
- Do not remove the covers of this machine. There are some sections to which high voltage is applied inside this machine. Removing the covers may result in electric shock.
- Do not disassemble or modify this machine. It may result in fire or electric shock. 
- If this machine emits excessive heat, smoke or foul odor, immediately turn off the power switch, unplug the power cord, and consult your dealer or authorized service representative. Failure to do so may result in fire or electric shock. For more information, consult your dealer or authorized service representative. 
- If foreign matter enters this machine, immediately turn off the power switch of the main unit, unplug the power cord and consult your dealer or authorized service representative. If you continue to use this machine without taking appropriate measures, it may result in fire or electric shock. 

Caution

- When you want to move this machine, consult your dealer or authorized service representative. Forcibly moving this machine by yourself could topple the machine over, and may result in injury.
- Do not perform any procedures (adjustment, repair, etc.) that are not described in this guide. When you want to adjust or repair, consult your dealer or authorized service representative.
- Allow plenty of ventilation during printing.
- Do not directly touch the thermal print head with your fingers. The thermal print head may be heated and cause burns.
- Do not touch the sections currently in operation in this machine. It may result in injury.
- Do not stick body parts such as your fingers into the openings around the paper feed tray or the paper receiving tray. It may result in injury.
- When you put your hands inside the main unit, take care not to touch any protrusions or edges of the metal plate. It may result in injury.
- When you put your hands inside the main unit, take care not to touch the paper separation hook or master removal hooks. The sharp tips of these hooks can hurt your hands. 
- Be sure to turn off the power to this machine when cleaning the pressure roller.
- Ink may be left on the areas near the print drum (cylinder) and the inside of the main unit after the print drum (cylinder) unit has been removed. Take care not to smudge your hands or clothes with the ink. Wash immediately with soap if you get ink on your hands, etc.
- Do not stand the print drum (cylinder) vertically. Doing so may stain the floor, etc.

Ink

Caution

- If ink gets in your eyes, immediately rinse it off completely with a large amount of water.
- If it gets on your skin, wash it off thoroughly using soap.
- If it is swallowed by accident, do not induce vomiting. Instead, drink a large amount of water or milk, and see if the condition improves.
- If you feel any abnormalities, immediately seek medical treatment.
- Only use the ink for printing purposes.
- Keep the ink out of the reach of children.

Locations of caution labels

This machine has some caution labels to ensure safe operation. Follow the indications of those labels and use this machine safely.

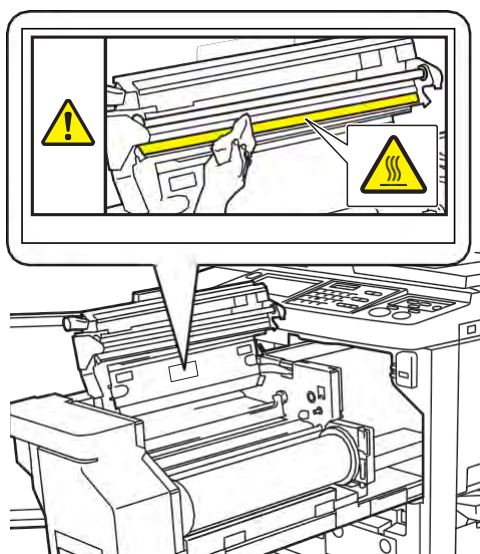

Before Starting Use

This section describes the precautions to be observed and the information that you need to be aware of before using this machine.

Precautions for installation

■ Required space

This machine requires the following space.

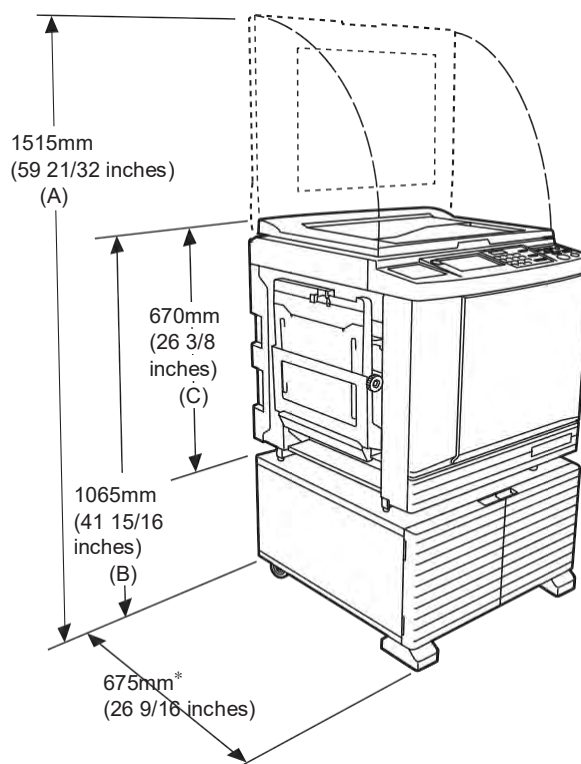

When the optional auto document feeder is installed, the values of (A) to (C) in the figure above are as follows.

(A) 1440 mm (56 11/16 inches)

(B) 1100 mm (43 5/16 inches)

(C) 705 mm (27 3/4 inches)

* The depth of the main unit includes the dedicated rack (RISO Stand D Type III) and stabilizers.

Top view

- When in use

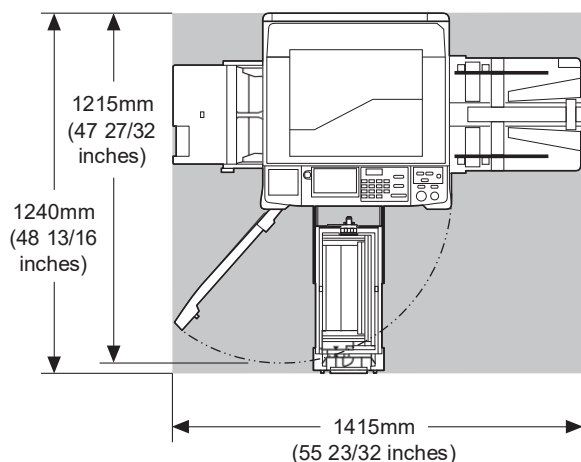

- When in storage

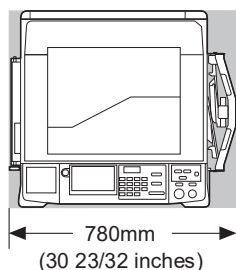

■ Installation location

- The installation location of this machine will be determined in consultation with you during delivery.
- The installation location of the machine should be fixed. When you want to move this machine, consult your dealer or authorized service representative.
- Do not install this machine in the locations listed below. Failure to observe this precaution may result in malfunction, failure, or accident.
 - Locations with exposure to direct sunlight and locations close to windows (cover the windows with curtains if necessary)
 - Locations that are subject to sudden changes in temperature
 - Extremely hot and humid locations or cold and dry locations
 - Locations exposed to fire or heat, direct cold air (e.g., air conditioner), direct hot air (e.g., heater), or where heat is transmitted
 - Locations with poor permeability and ventilation
- Choose a location where this machine is level when it is installed. (Levelness for installation: 10 mm [25/64 inches] or less both lengthwise and widthwise)
- The appropriate environment conditions are as follows.
 - Temperature range: 15°C to 30°C (59°F to 86°F)
 - Humidity range: 40% to 70% (no condensation)



Precautions for use

■ Power connection

- Be sure to plug in the power cord securely to prevent poor contact in the power plug section.
- Locate this machine near the electric outlet.



■ Operations

- Do not turn off the power or unplug the power cord during operation.
- Do not open covers or move this machine during operation.
- Open and close covers gently.
- Do not put any heavy objects on this machine.
- Avoid excessive impact on this machine.
- This machine contains precision parts and drive mechanisms. Perform only the procedures described in this guide.

Consumables

- For the ink and master rolls, it is recommended to use the products specified by RISO.
- Genuine RISO inks and master rolls are engineered for maximum performance and maximum life, and RISO equipment is designed to give excellent performance when used with genuine RISO consumables. However, all consumables can and do deteriorate over time. We recommend that you use ink and master rolls as soon as possible after purchase, and within 24 months of the date of manufacturing. You can find the date of manufacturing on the ink cartridge or the inside of master core. RISO genuine consumables transmit information regarding the age of the consumables that allows the machine to make adjustment based on the age of the consumables, e.g., time remaining until the Use By date.
- Store the paper, master rolls, and ink cartridges properly according to the instructions indicated on each container.
- Do not store those parts in the locations listed below.
 - Locations with exposure to direct sunlight and locations close to windows (cover the windows with curtains if necessary)
 - Locations that are subject to sudden changes in temperature
 - Extremely hot and humid locations or cold and dry locations



Printing of original data

The following methods are available for printing original data that was created using a computer.

■ Method to connect with the computer using a USB cable

A commercially available USB cable is required for connection. Use a cable of 3 m (10 feet) or shorter that conforms to the USB 2.0 standard.



B When connecting using a USB cable, be sure that the power for this machine and the computer is turned on.

B If you use a USB hub, the machine may not work properly.

B The maximum allowable voltage for USB port input and output is 5V.

■ Method to connect with the computer using a network

Use a commercially available Ethernet cable (shielded twist pair cable that supports 10BASE-T or 100BASE-TX).

■ Method to use a USB flash drive

- Use a USB flash drive that is compatible with the USB mass-storage device class. Some USB flash drives may not work properly.
- Use a USB flash drive that was formatted to FAT.
- A USB flash drive that features a security function may not work properly.



B Connect or disconnect the USB flash drive slowly according to the proper procedures.
(A 41 “Printing from [USB Job List]”)

B We cannot guarantee data that is saved on the USB flash drive against loss that is caused by natural disasters or unforeseen events. We recommend that you use your computer to make back-up copies of any important documents.

■ Method for using a Paper Memory Original

- Convert the original data into a Paper Memory Original using the printer driver function of this machine, and then print the Paper Memory Original with a laser printer.
- Using the [Paper Memory Print] function (A 64), this machine can handle Paper Memory Originals.



B This machine may not be able to scan the Paper Memory Original properly in the following cases:

- **C** The glass platen or platen cover pad is stained.
- **C** The Paper Memory Original is stained, wrinkled, or creased.
- **C** The Paper Memory Original has writing in an undesignated area (A 64).

Software

The software included in the DVD-ROM and the CD-ROM provided for this machine is as follows:

■ RISO Printer Driver

This is a dedicated printer driver that enables printing an original from a computer.

You can also convert original data created on a computer and create a Paper Memory Original for [Paper Memory Print] (A 64).

For more information, see the user's guide (PDF file) included in the DVD-ROM.

■ RISO Utility Software

The following two software programs are included in the CD-ROM:

- **RISO USB PRINT MANAGER**
You can manage the information of the original data in the USB flash drive on a computer.
- **RISO COPY COUNT VIEWER**
You can manage the copy count data that was saved or sent by [ID Counter Report] (A 96).
For more information, see the user's guide (PDF file) included in the CD-ROM.

Originals

Size and weight

The following sizes and weights of originals are usable:

When using the glass platen

Size	50 mm × 90 mm to 310 mm × 432 mm (1 31/32 inches × 3 17/32 inches to 12 7/32 inches × 17 inches)
Weight	10 kg (22 lb) at maximum

When using the optional auto document feeder

Size	100 mm × 148 mm to 300 mm × 432 mm (3 15/16 inches × 5 13/16 inches to 11 13/16 inches × 17 inches)
Weight	50 g/m ² to 128 g/m ² (13-lb bond to 34-lb bond)

- Do not mix originals of different sizes for the auto document feeder.
- You can place up to approximately 50 sheets of originals (when using originals of 80 g/m² [21-lb bond] or less) in the auto document feeder at the same time.



B The following originals cannot be used in the auto document feeder. Place the original on the glass platen.

- C Patched original
- C Excessively wrinkled, curled, or creased original
- C Original with sticky areas or holes
- C Torn original or deckle-edged original
- C Chemically treated original (such as thermal or carbon paper)
- C Transparent original (such as OHP films or tracing paper)
- C Original with correction fluid or glue
- C Extremely thin original (less than 50 g/m² [13-lb bond])
- C Extremely thick original (greater than 128 g/m² [34-lb bond])
- C Original with slippery surface (such as art or coated paper)
- C Original with glossy surfaces
- C Original with staples or clips

- If an original is excessively wrinkled, curled, or creased, flatten it thoroughly so that the entire original is securely placed on the glass platen. Areas that come off from the glass platen may be printed in black.
- If ink or correction fluid is used on an original, thoroughly dry it before placement. Failure to do so may contaminate the glass platen, and this impairs proper printing.

Direction of original

Each direction of an original is referred to as follows in this guide:

- When placing an original on the glass platen:
The side that faces the reference position (H symbol) is referred to as the “top”.

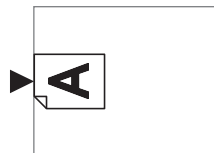

- When placing an original on the optional auto document feeder:
The leading edge in the feeding direction is referred to as the “top”.

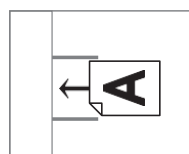

Printing papers

- If you use papers outside the specifications of this machine, RISO does not assure the paper feeding and printing performance with these papers.



B Please note that even with paper of a size and weight that conforms to the specifications of this machine, this machine may not feed the paper depending on the paper type, environmental conditions, and storage conditions. For more information, consult your dealer or authorized service representative.

Paper size

- The following sizes of paper are usable*:
100 mm × 148 mm to 310 mm × 432 mm
(3 15/16 inches × 5 13/16 inches to
12 7/32 inches × 17 inches)

*When the optional Wide Stacking Tray is installed, papers of sizes up to 310 mm × 555 mm (12 7/32 inches × 21 27/32 inches) are usable after setting [Custom Paper Entry] (A 119). Depending on the paper type and paper size, papers may not be aligned properly.

- This machine detects the following papers as standard size paper.

SF9450EII

Ledgerp	11 inches × 17 inches
Legalp	8 1/2 inches × 14 inches
Letterp	8 1/2 inches × 11 inches
Lettern	11 inches × 8 1/2 inches

Statement P	5 1/2 inches × 8 1/2 inches
----------------	-----------------------------

SF9350EII/SF9250EII

A3p	297 mm × 420 mm (11 11/16 inches × 16 17/32 inches)
A4p	210 mm × 297 mm (8 1/4 inches × 11 11/16 inches)
A4n	297 mm × 210 mm (11 11/16 inches × 8 1/4 inches)
B4p	257 mm × 364 mm (10 1/8 inches × 14 11/32 inches)
B5p	182 mm × 257 mm (7 5/32 inches × 10 1/8 inches)
B5n	257 mm × 182 mm (10 1/8 inches × 7 5/32 inches)
Foolscap P	215.9 mm × 330.2 mm (8 1/2 inches × 13 inches)

■ Paper type

- The following paper types are usable:
46 g/m² to 210 g/m² (12-lb bond to 116-lb index)

■ To prevent paper jams and paper feeding failures

- Place the paper so that its grain (flow of the grain) is aligned with the paper feeding direction.
If the paper grain is set perpendicularly to the paper feeding direction, the resilience of the paper will decrease, and it may result in a paper jam.

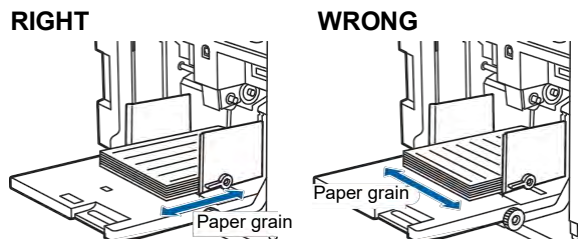

You can check the paper grain by tearing the paper. The direction in which the paper tears straight is the paper grain.



The paper tears straight if you tear it along the paper grain.



The paper does not tear straight if you tear it perpendicularly to the paper grain.

- When using poorly cut paper or coarse surfaced paper (drawing paper, etc.), separate the paper before use.
- Depending on the type of paper to be used, paper dust may be generated during use of this machine. Please clean and ventilate the area adequately.
- When using thick paper (drawing paper, etc.) or paper with a slippery surface, adjust the paper feed setting lever or paper arranger for the paper receiving tray.
(A 28 "Preparation before Printing")
- Use flat paper. If it is unavoidable to use curled paper, place the printing paper so that the inner curled part faces up.



- If the margin at the top of the printed paper (leading edge in the paper output direction) is too small or if a highly dense image is located at the top of the printed paper, the paper may adhere to the print drum (cylinder). In this case, lower the print position to allow a larger margin at the top or rotate the top-and-bottom direction of the original, and then make a master again.

■ Paper storage

Store paper in a dry area. Paper containing moisture can result in paper jams or poor print quality.

■ Inappropriate paper for printing

Do not use the types of paper listed below, as it can result in a paper jam.

- Extremely thin paper (less than 46 g/m² [12-lb bond])
- Extremely thick paper (greater than 210 g/m² [116-lb index])
- Chemically treated paper (such as thermal or carbon paper)
- Excessively wrinkled, curled, creased, or torn paper
- Paper coated on one side or both sides
- Deckle-edged paper
- Art paper
- Paper with sticky areas or holes

■ Direction of paper

The leading edge in the paper feeding direction is referred to as the “top” in this guide.



Printing area

■ Maximum Printing Area

The maximum printing area of this machine is as follows:

Model	Maximum printing area
SF9450EII	291 mm × 425 mm (11 15/32 inches × 16 23/32 inches)
SF9350EII	291 mm × 413 mm (11 15/32 inches × 16 1/4 inches)
SF9250EII	251 mm × 357 mm (9 7/8 inches × 14 1/16 inches)

■ Master making area

The master making area is determined according to the paper size placed on the paper feed tray. The master making area is an area that equals the paper size excluding the margin shown in the illustration below.

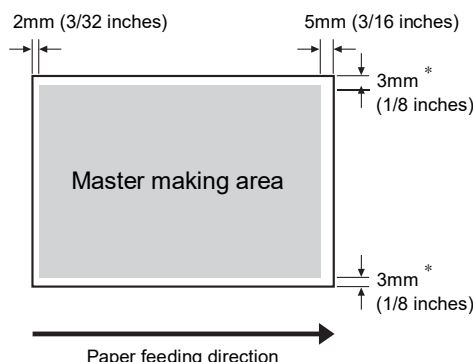

* These values are for cases when using standard size paper. When using custom size paper, these values are 5 mm (3/16 inches).

When creating originals, take above margins into consideration.

The same master making area is applied when printing by sending original data from a computer.

! The master making area does not exceed the maximum printing area even when you set large paper.

B Even when you set [Max. Scan] (A 56), master making is not performed within the area of 5 mm (3/16 inches) from the paper edge.

! When printing an original with little margin around the original, it is useful to reduce the original by setting [Margin+] (A 53).

B You can set [Max. Scan] (A 56) to enlarge the master making area up to the maximum printing area, regardless of the paper size.

Materials not to be printed

Do not use this machine in any manner which violates the laws or infringes on established copyrights, even when making copies for personal use. Consult your local authorities for further details. In general, use discretion and common sense.



Chapter **1**

1

About This Machine

Name and Function of Each Part

Paper feeding side

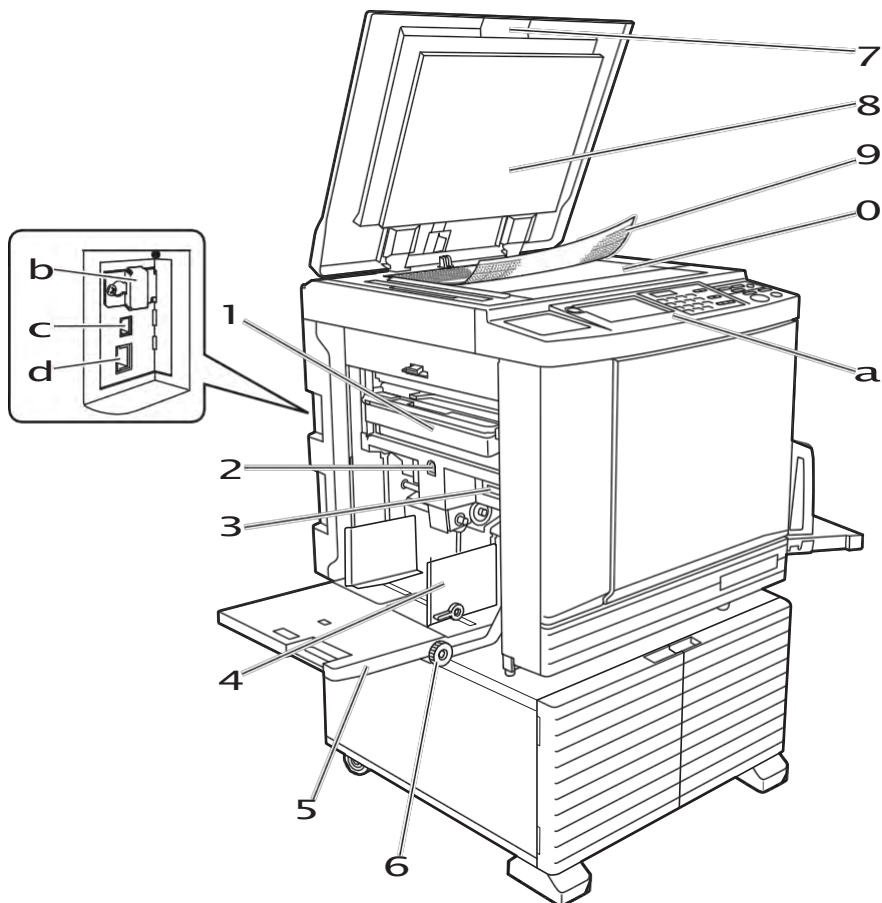

- | | |
|---|---|
| <p>1 Master disposal box (A 141)
Collects masters that are disposed of.</p> <p>2 Feed tray ascent / descent button (A 28)
Raises or lowers the paper feed tray when you replace or add the paper.</p> <p>3 Paper feed setting lever (A 28)
Adjusts the paper-feed pressure according to the paper type.</p> <p>4 Feed-tray paper guides (A 28)
Slide these guides to fit the paper width to prevent misalignment of the paper.</p> <p>5 Paper feed tray (A 28)
Place the paper on this tray.</p> <p>6 Vertical print position adjustment dial (A 74)
Adjusts the printing position in the vertical direction.</p> <p>7 Platen cover (A 32)
Open / close this cover when placing an original.</p> | <p>8 Platen cover pad (A 149)</p> <p>9 Gauge cover (A 32)
Useful for adjusting the position of an original.</p> <p>O Glass platen (A 32)
Place the original facing down.</p> <p>a Control panel (A 21)
Perform the required operations.</p> <p>b Memory card slot (A 38)
Insert a memory card to use the [Storage] function.</p> <p>c USB port (Type B) (A 13)
Plug in a USB cable to connect this machine with a computer.</p> <p>d LAN port (A 13)
Plug in an Ethernet cable to connect this machine to the network.</p> |
|---|---|

Paper receiving side

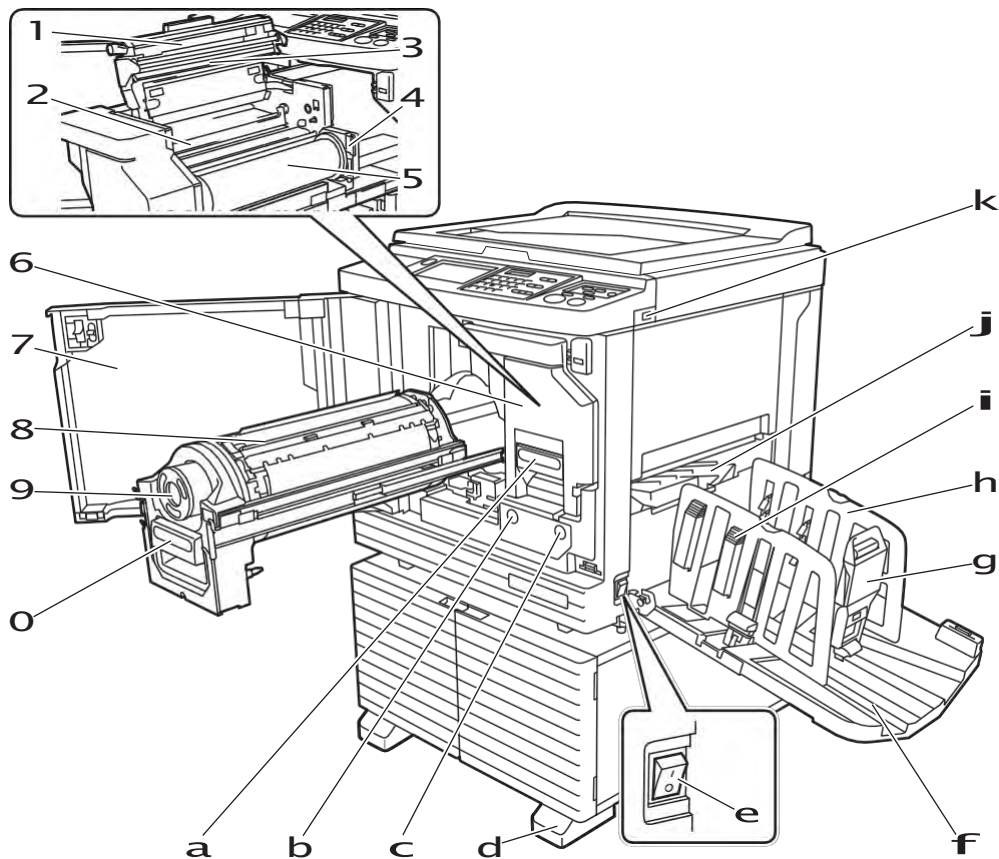

- 1 Master making unit cover (A 138)**
- 2 Master guide flap (A 139)**
- 3 Thermal print head (A 148)**
- 4 Master roll holder (A 138)**
Secures a master roll that is set.
- 5 Master roll (A 137)**
- 6 Master making unit (A 137)**
See numbers 1 to 5.
- 7 Front door (A 137)**
- 8 Print drum (cylinder) (A 143)**
- 9 Ink cartridge (A 140)**
- O Print drum (cylinder) handle (A 143)**
Grip this handle to pull out the print drum (cylinder).
- a Master making unit handle (A 137)**
Grip this handle to pull out the master making unit.
- b Print Drum (Cylinder) Release Button (A 143)**
You can pull out the print drum (cylinder) while this button is lit.
When the button is not lit, press the button to light it up and then pull out the print drum (cylinder).
- c Master Making Unit Release Button (A 137)**
You can pull out the master making unit while this button is lit.
When the button is not lit, press the button to light it up and then pull out the master making unit.
- d Stabilizer**
- e Power switch (A 33)**
Turns on / off the power supply.
- f Paper receiving tray (A 29)**
The printed paper is output to this tray.
- g Paper stopper (A 29)**
Slide this stopper to fit the paper size.
- h Receiving-tray paper guides (A 29)**
Slide these guides to fit the paper size.
- i Paper arranger knob (A 29)**
Press this knob to open the paper arranger.
The paper arranger helps improve the arrangement state of the printed paper.
- j Paper jumping wing (A 81)**
- k USB port (A 41)**
Insert a USB flash drive for authentication or printing.

Option

■ Auto Document Feeder

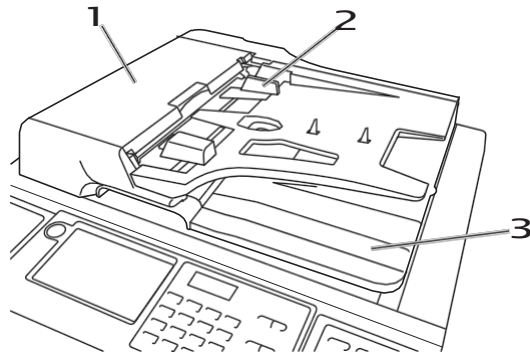

- 1 ADF cover (A 158)**
Open this cover when a paper jam occurs to remove the original.
- 2 ADF original guides (A 32)**
Slide these guides to fit the original width to prevent misalignment of the original.
- 3 ADF original receiving tray**
The original that has been scanned is output to this tray.

Control panel

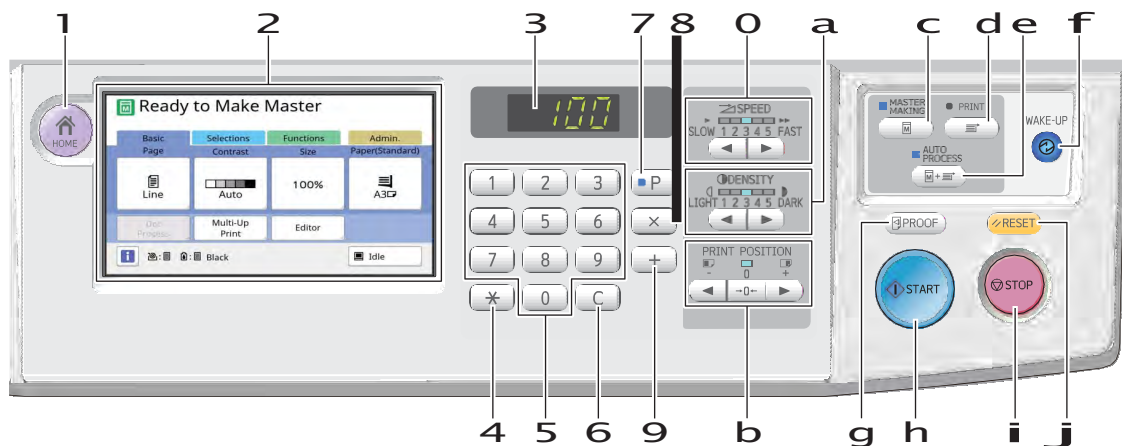

- 1 [HOME] key (A 22)**
Press this key to display the [HOME] screen.
- 2 Touch panel (A 22)**
- 3 Numeric display**
Shows the number of prints and the entered values for various settings.
- 4 [0] key**
Press this key to open the [Job Memory] (A 90) screen and select an entry field in [Program] (A 85).
- 5 Numeric keys**
Press these keys to enter the number of prints and the values for various settings.
- 6 [C] key**
Press this key to clear the entered characters and numbers.
- 7 [P] key (A 85)**
Press this key to open the [Program] screen. When [Program] is turned on, the key lamp is lit.
- 8 [X] key**
Press this key to select an entry field in [Program] (A 85).
- 9 [+] key**
Press this key to select an entry field in [Program] (A 85).
- 0 [SPEED] keys (A 72)**
Press these keys to adjust the print speed. The lamp above these keys shows the current speed.
- a [DENSITY] keys (A 73)**
Press these keys to adjust the print density. The lamp above these keys shows the current print density.
- b [PRINT POSITION] keys (A 74)**
Press these keys to adjust the print position in the horizontal direction after master making.
- c [MASTER MAKING] key (A 33)**
Press this key to display the master making basic screen.
- d [PRINT] key**
Press this key to display the printing process basic screen.
- e [AUTO PROCESS] key (A 25)**
Press this key to turn on / off [AUTO PROCESS]. When [AUTO PROCESS] is turned on, the lamp above the key is lit.
- f [WAKE-UP] key**
 - When this machine is in the sleep (power saving) status, the key lamp is lit. Press this key to activate this machine.
 - When the authentication function (A 122) is enabled, the key lamp is lit while the user is authenticated. Press this key to cancel the authentication status. (A 44 "Releasing the authentication status")
- g [PROOF] key (A 33)**
Press this key to output a proof copy.
- h [START] key**
Press this key to start the master making process and the printing process as well as to start various operations.
The key lamp is lit when the operation is available and not lit when the operation is not available.
- i [STOP] key**
Press this key to stop the operation in progress. If this key is pressed while master making is in progress, the operation stops after the master making process is complete.
- j [RESET] key**
Press this key to reset the current setting to its default value or clear error displays after troubleshooting.

Touch Panel Displays

This section describes typical screen displays.

[HOME] screen

This screen is used to select an operation mode. This screen is displayed when you press the [HOME] key.

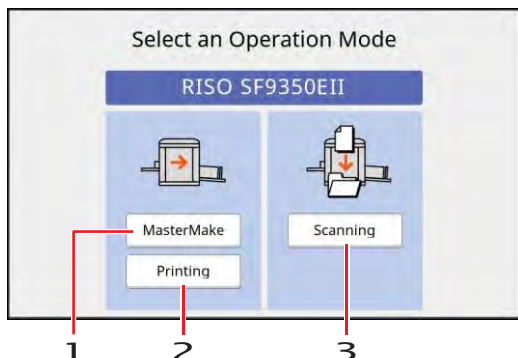

- 1 [MasterMake]**
Touch this button to move to the master making basic screen.
- 2 [Printing]**
Touch this button to move to the print basic screen.
- 3 [Scanning]**
Touch this button to move to the scan basic screen.
(A 38 "Saving Paper Original as Data")

Authentication screen

This screen is displayed when the authentication function (A 122) is enabled. Operate according to the guidance.

■ When [PIN Code] is used for authentication



■ When [USB Flash Drive] is used for authentication



■ When [IC Card] is used for authentication



Master making basic screen

This screen is used to set functions for master making. Some display items are different between when a paper original is used and when a data original is used.

■ For paper original

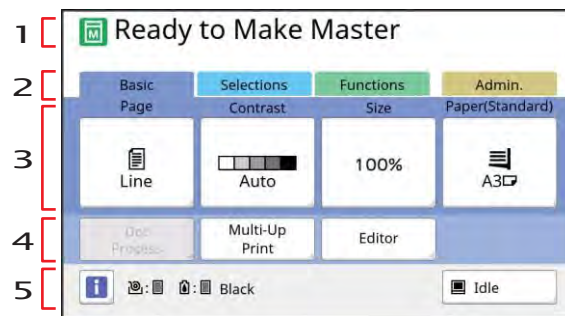

- 1 Message area**
Shows the status of this machine and operation instructions.

Display	Description
	Master making mode
	[Quick Master Making] (A 53)
	[Idling Action] (A 92)

2 Tab buttons

You can change tab screens by touching each tab.

3 Function setting area

Shows the function buttons that can be set.

4 Direct Access Area

It is useful if you register functions that are used frequently in this area.

(A 94 “Registering Frequently Used Functions for Each User [My Direct Access]”)

(A 117 “Registering Frequently Used Functions in the [Basic] Tab Screen [DirectAccess Entry]”)

5 Status area

Shows the status of this machine.

Display	Description
	Touch [I] to show the information such as [Consumables Amount]. The color of the [I] icon shows the status of this machine. (A 136 “Checking the Remaining Amount of Consumables”)
	Shows the remaining amount of the masters that are set in this machine. (A 136 “Checking the Remaining Amount of Consumables”)
	Shows the color name and remaining amount of the ink that is set in this machine. (A 136 “Checking the Remaining Amount of Consumables”)
	Shows the status of original data received from the computer. [READY]: Waiting for data reception. [Data-Map]: Process required before printing is in progress. [Pause]: Original data that can be printed is ready on the job list. [Error]: A communication error occurred. [Blocked]: Data cannot be received. When you touch this button, the [Job List] screen is displayed. (A 34 “Printing from Computer”)

■ For data original

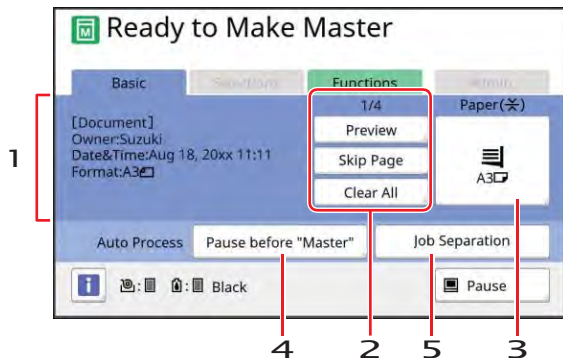

1 Original data information area

Shows the information of the original data, such as the name, size, and so on.

2 Original data operation area

[n/m]: Shows “current page / total number of pages”.

[Preview]: You can see [Preview] (A 63) of the current page.

[Skip Page]: You can start master making of the next page without starting master making of the current page.

[Clear All]: Stops the current original data processing.

3 [Paper]

Check that the set paper size matches the original data size. When using a custom size paper, select a paper size that has been registered.

(A 55 “Using Custom Size Paper [Paper Size]”)

4 [Auto Process]

You can change the operation stop timing during printing.

(A 34 “Printing from Computer”)

5 [Job Separation]

This is displayed when the optional Job Separator has been installed.

1

Print basic screen

This screen is used to set functions for the printing process.

Some display items are different between when a paper original is used and when a data original is used.

■ For paper original

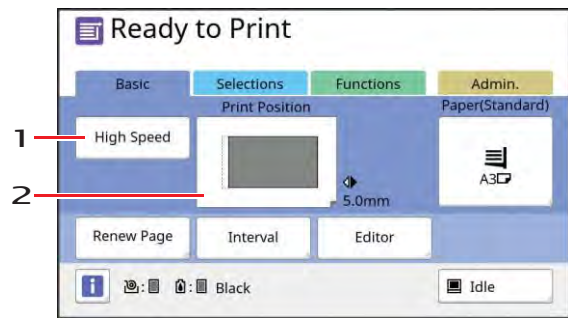

1 [High Speed]

Turns on / off the [High Speed] setting.

(A 72 “Adjusting the Print Speed [SPEED]”)

2 [Print Position]

Shows the print position adjustment value in the horizontal direction.

(A 74 “Adjusting the Print Position [PRINT POSITION]”)

■ For data original

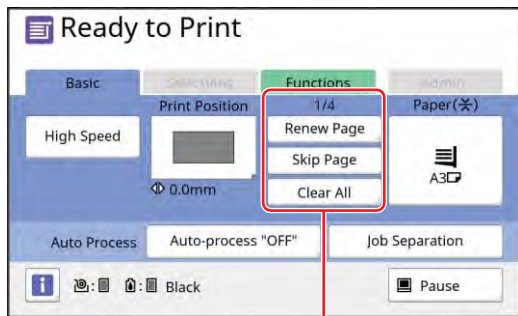

1 Original data operation area

[Renew Page]: You can perform master making again when the master that is being used for printing is deteriorated.
 (A 76 “Making a Master Again [Renew Page]”)
 For other display items, see the description for the master making basic screen.

Scan basic screen

This screen is used to configure settings for scanning a paper original on this machine and saving it as data.

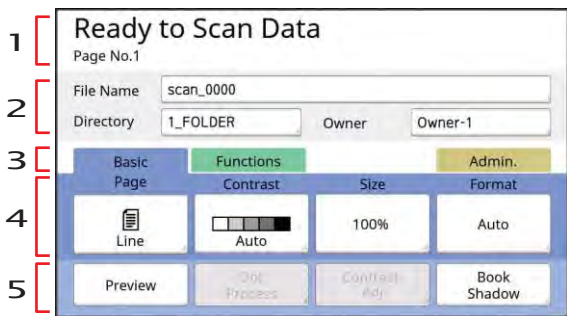

1 Message area

Shows the status of this machine and operation instructions.
 Touch [End] to save the scanned original data.

2 Basic information area

You can configure settings for the original data to be saved.
 [File Name] (A 105)
 [Directory] (A 105)
 [Owner] (A 106)

3 Tab buttons

You can change tab screens by touching each tab.

4 Function setting area

Shows the function buttons that can be set.

5 Direct Access Area

It is useful if you register functions that are used frequently in this area.
 (A 94 “Registering Frequently Used Functions for Each User [My Direct Access]”)
 (A 117 “Registering Frequently Used Functions in the [Basic] Tab Screen [DirectAccess Entry]”)

[Rename] screen

This screen is displayed when you need to enter characters.

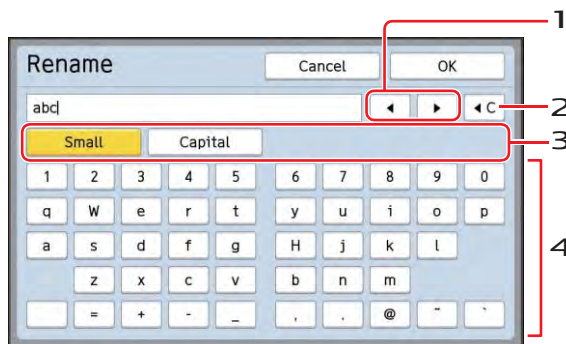

1 Cursor moving buttons

You can move the position to enter a character to the left or right.

2 Erase one character button

Touch this button to erase characters one by one.

3 Change character type buttons

You can change the type of characters to enter.

4 Character buttons

Touch these buttons to enter characters.

Printing Flow

“Master making process” and “Printing process”

This machine is a digital duplicator that uses the screen printing method. The screen printing method first forms minute holes on a master (plate), which is the base of the printing process. Then, ink is applied through these holes to transfer images onto paper.

In the screen printing method, “master making process” refers to the steps to create a master, and “printing process” refers to the steps in which the ink goes through the created master and the image is transferred onto paper. In this guide, “master making process” and “printing process” are together called “printing”.

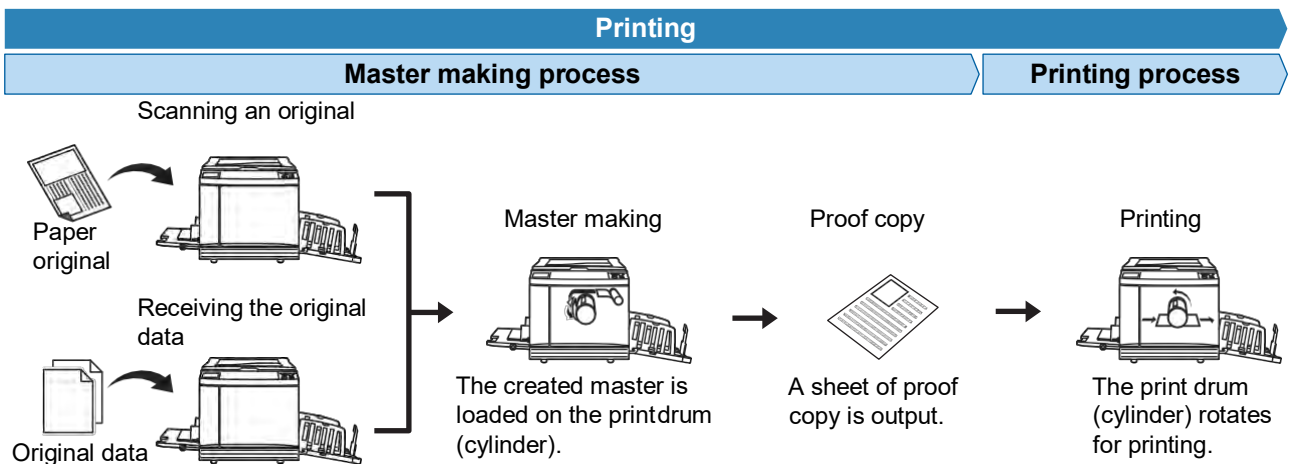

What is [Auto Process]?

[Auto Process] refers to continuous operation of the master making process and the printing process. You can turn on / off the [Auto Process] setting by pressing the [AUTO PROCESS] key (A 21).

■ When [Auto Process] is on

After the master making process, the printing process starts.

After the printing process is complete, if there is a next original on the optional auto document feeder, master making for it starts.

If the original is placed on the glass platen, the operation stops after the completion of the printing process.

Use this setting when you do not need to check the proof copy or change the printing conditions and the master making conditions.



■ When [Auto Process] is off

Operation stops after each process: master-making and printing.

Use this setting when you need to change the printing conditions after checking the proof copies or when you need to replace the paper.

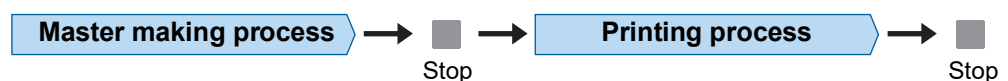



Chapter **2**

Basic Operations

Preparation before Printing

Setting up the paper feed tray and the paper

- 1 Open the paper feed tray.**
While holding the paper feed tray with your hand, open it until it stops.

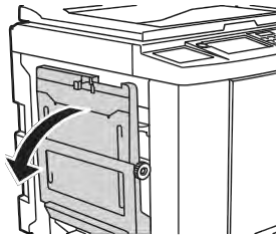

- 2 Place the paper on the paper feed tray.**
Place the paper with the printing side facing up. Use the same orientation as that of the original. (A 31 "Placement of Originals")

! Do not use inappropriate paper or mix paper of different sizes. It may cause a paper jam or damage your printer.
(A 14 "Printing papers")

- 3 Adjust the feed-tray paper guides.**
Raise the lock levers on both sides of the feed-tray paper guides so that you can slide the feed-tray paper guides by hand. Tightly fit the feed-tray paper guides to the paper, and then push down the lock levers on both sides to lock the guides.

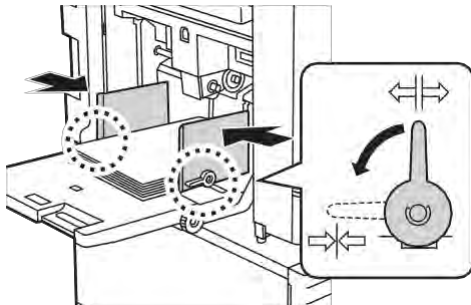

! This machine identifies the paper size according to the position of the feed-tray paper guides. If the feed-tray paper guides do not fit tightly to the paper, the paper size cannot be identified correctly.

B When you are using custom size paper, specify the paper size on the control panel.
(A 55 "Using Custom Size Paper [Paper Size]")

- 4 Adjust the paper feed pressure.**
Select the position of the paper-feed setting lever according to the paper type.

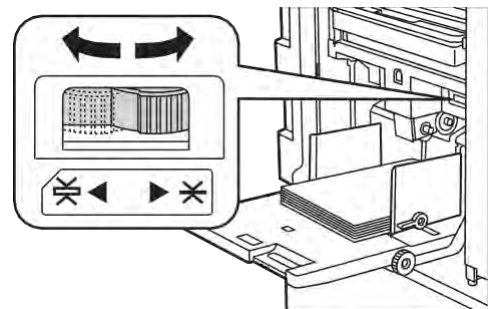

Lever	Paper type
U (NORMAL)	Newsprint paper Fine paper
Z (CARD)	Smooth cardstock Thick paper such as drawing paper

B The position of the paper-feed setting lever is displayed next to [Paper] in the master making basic screen.

Adding and replacing the paper

Lower the paper feed tray to a position where you can easily remove and place paper before adding or replacing paper during the printing process. When you press and hold the feed tray ascent / descent button (A 18), the paper feed tray stops the moment you release your finger from the button.

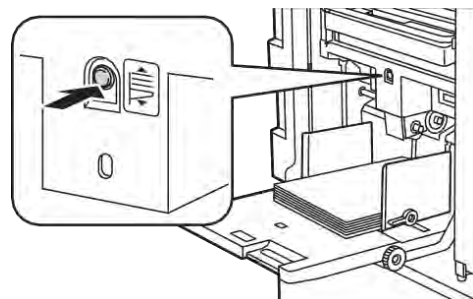

! After replacing the paper with that of a different type, reposition the paper-feed setting lever.

B After replacing the paper with that of a different size, also adjust the receiving-tray paper guides and the paper stopper.

 When the paper runs out or all of the paper is removed, the paper feed tray lowers to the bottom automatically.

How to close the paper feed tray

1 **Remove all of the paper.**
After removing the paper, check that the paper feed tray is lowered to the bottom.

2 **Slide the feed-tray paper guides to the ends.**

Raise the lock levers for the feed-tray paper guides and slide the feed-tray paper guides by hand.

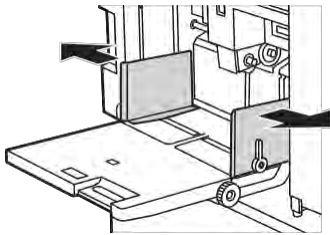

3 **Close the paper feed tray.**

Setting up the paper receiving tray

1 **Open the paper receiving tray.**
While holding the paper receiving tray with your hand, open it until it stops.

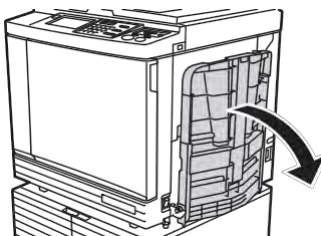

2 **Raise the receiving-tray paper guides and the paper stopper.**

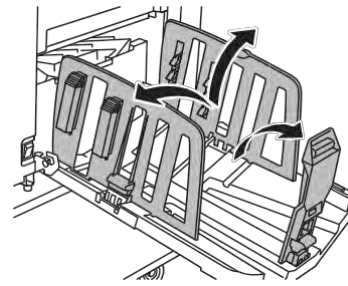

3 **Fit the receiving-tray paper guides and the paper stopper to the paper size.**

Hold the lower parts of the receiving-tray paper guides and the paper stopper, and then slide the guides and the stopper.

Adjust each position while referring to the scale marks on the paper receiving tray.

The paper stopper stops with a click sound at each position corresponding to the standard size of a paper type.

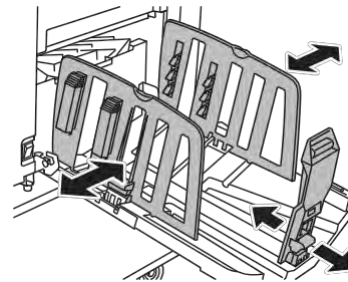

! When using thick paper, set the receiving-tray paper guides a little wider than the actual paper width.

B The optimal position of the receiving-tray paper guides varies depending on conditions such as the paper type, print speed, and operation environment. Use the scale marks on the paper receiving tray as a reference only. Adjust the position of the receiving-tray paper guides based on the actual arrangement of the printed paper.

B When adjusting the horizontal position of the paper feed tray, also adjust the position of the receiving-tray paper guides. If the positions of the paper feed tray and the receiving-tray paper guides are not aligned, a paper jam may occur.

4 Adjust the paper arrangers.

Adjust the paper arrangers so that printed paper is aligned.

- To open a paper arranger, press down the paper arranger knob.
- To close a paper arranger, pull up the paper arranger knob.

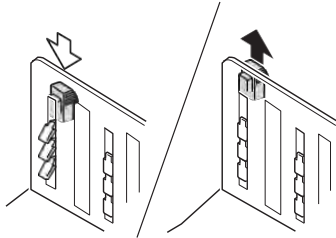

■ For normal paper

Open all four of the paper arrangers.

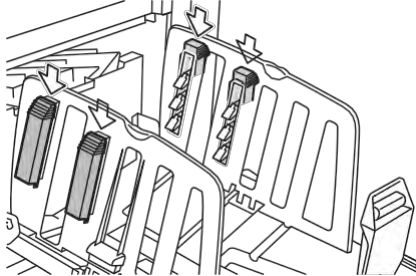

■ When a printed area is concentrated on one side of the page

Open the paper arrangers on the side with more printed ink.

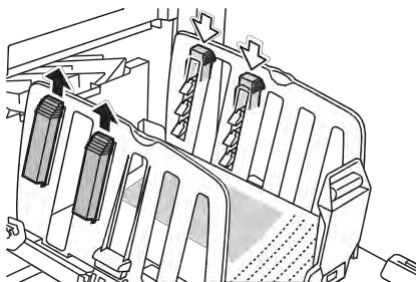

■ For thick paper

Open only the paper arrangers that are close to the machine.

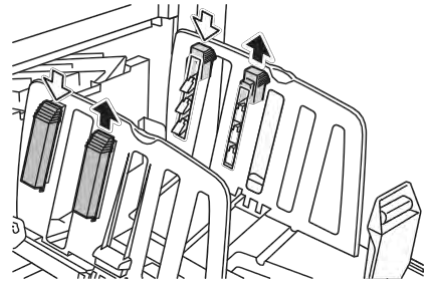

■ How to close the paper receiving tray

- 1 Remove all of the printed paper.
- 2 Slide the receiving-tray paper guides and paper stopper to the ends.

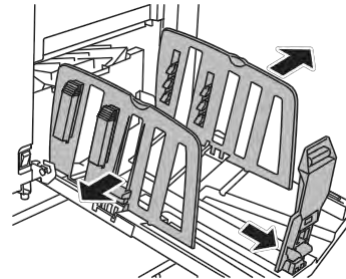

- 3 Close all of the paper arrangers.

- 4 Fold the paper stopper inward.

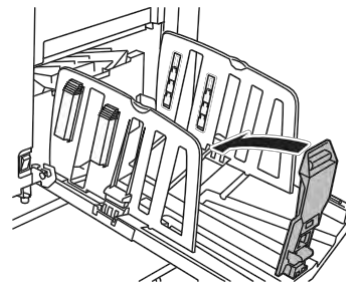

- 5 Fold the receiving-tray paper guides inward.

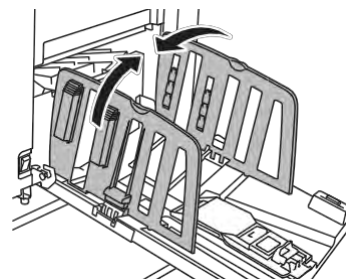

6 Close the paper receiving tray.

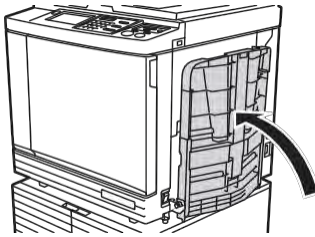

Placement of Originals

Originals can be scanned by using the glass platen or the optional auto document feeder.

■ Relation of original and paper orientations

Make sure that the orientations of the original and the paper are as shown below.

Short edge paper feed

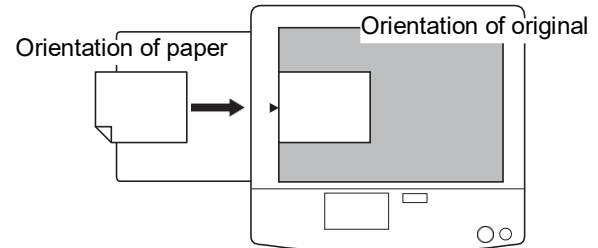

Long edge paper feed

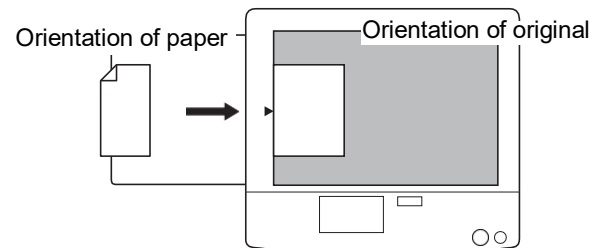

- 
B The maximum printing area varies depending on the model.
 (A 16 “Maximum Printing Area”)
If the original is larger than the maximum printing area, reduce its size to make a master.
 (A 53 “Enlarging or Reducing the Size of the Original [Size]”)

- 
B When [Multi-Up Print] (A 56) or [2 Up] (60) is selected, the orientations of the original and the paper vary depending on the setting.

When using the glass platen

1 Open the platen cover.

2 Place an original on the glass platen.

Place the original with the scanning side facing down and align the center of the original with the [H] mark.

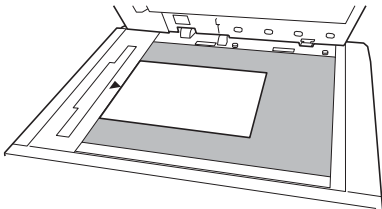

B When a gauge cover is attached on the glass platen, place the original under the gauge cover. You can lift the gauge cover from the lower right.

Gauge cover

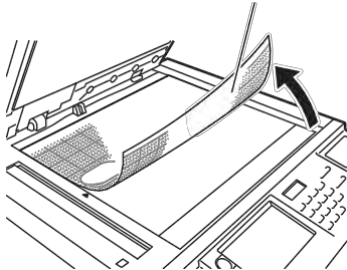

3 Close the platen cover.



B Close the platen cover gently. Forcefully closing the platen cover will cause damage to the glass platen or original scanning errors.

When using the auto document feeder

1 Place originals on the auto document feeder.

Place the originals with the scanning side facing up.

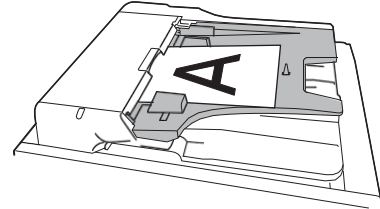

B For the auto document feeder, the size and the number of originals to be placed are limited. (A 14 “Originals”)

2 Adjust the ADF original guides to the width of the original.



B This machine identifies the original size by recognizing the positions of the ADF original guides. If the ADF original guides do not fit tightly to the original, the original size cannot be identified correctly.

Printing of Paper Originals

This section describes the procedure to scan and print paper originals.

1 Check that the power switch of this machine is on.

Press the [X] side of the power switch.



B When an authentication screen (A 43) is displayed, follow the instructions on the screen.

2 Check that the master making basic screen is displayed.

If a screen other than the master making basic screen is displayed, press the [MASTER MAKING] key (A 21).

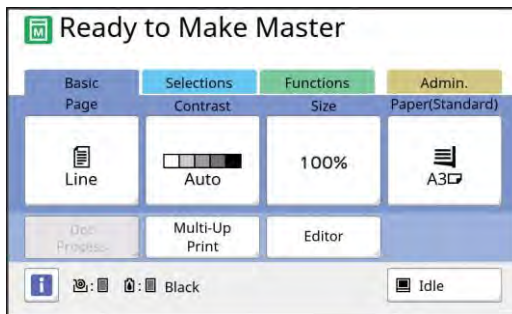

3 Place the original.

(A 31 "Placement of Originals")



B The size of the placed original on the optional auto document feeder is displayed next to [Page] in the master making basic screen. If the displayed size is different from the size of the placed original, place the original again.

4 Check the paper.

(A 28 "Setting up the paper feed tray and the paper")



B The size of the placed paper is displayed in [Paper] in the master making basic screen. If the displayed size is different from the size of the placed paper, place the paper again.

B The position of the paper-feed setting lever (A 28) is displayed next to [Paper] in the master making basic screen.

5 Check the paper receiving tray.

(A 29 "Setting up the paper receiving tray")

6 Check the [Auto Process] setting.

(A 25 "What is [Auto Process]?")



B When you place originals on the optional auto document feeder, [Auto Process] turns on automatically. You can change the default setting in [ADF Auto Process] (A 112) under [Admin.].

7 Set the master making conditions.

(A 46 "Functions for Master Making")

(A 84 "Useful Functions")

8 Enter the number of copies to be printed using the numeric keys.

9 Press the [START] key.

Master making starts and a proof copy is output.

- When the [Auto Process] setting is on, go to step 12.
- When the [Auto Process] setting is off, go to step 10.



B An idling action (to ensure the ink usability and stability) may be automatically executed. You can change the setting in [Auto Idling] (A 116) under [Admin.].

10 Set the printing conditions.

Check the printing position and density on the proof copy.

(A 72 "Functions for Printing")



B Press the [PROOF] key to check the output using another proof copy.

B If the machine has not been used for an extended period of time, the ink on the print drum (cylinder) dries and colors in the printed output may be faint or faded. If you find the case mentioned above, output several proof copies to ensure the usability and stability of the ink. You can output proof copies consecutively by continuously pressing the [PROOF] key.

11 Press the [START] key.

The printing process starts.



B To stop the printing process, press the [STOP] key.

12 Remove the printed copies.

Fold the receiving-tray paper guides outward so the printed paper can be removed easily.

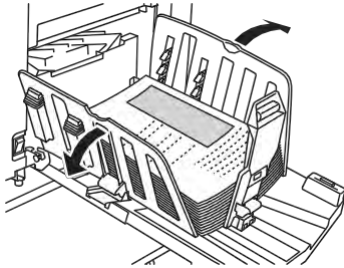

B To print more copies, enter the number of copies and press the [START] key.

B To start master making for the next original, repeat the procedure from step 3.

B When you place originals on the optional auto document feeder and the [ADF Semi-Auto] setting (A 112) is turned on, master making for the next original starts automatically. Repeat the procedure from step 10 for each original.

B To cancel the authentication status, press the [WAKE-UP] key. The authentication status is also cancelled when the time that is set in [Auto Clear] (A 115) or [Auto Sleep] (A 115) elapses. (A 44 “Releasing the authentication status”)

Printing from Computer

You can print the original data that was created using a computer on this machine.

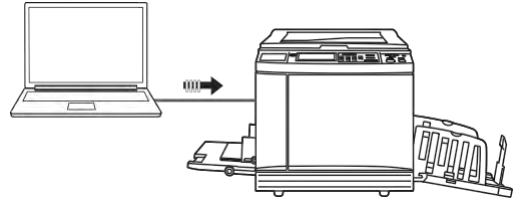

B Before printing, it is necessary to install the printer driver dedicated for this machine in the computer.

1 Turn on the power to this machine.

Press the [X] side of the power switch.



B When an authentication screen (A 22) is displayed, follow the instructions on the screen.

2 Check the paper.

(A 28 “Setting up the paper feed tray and the paper”)

3 Check the paper receiving tray.

(A 29 “Setting up the paper receiving tray”)

4 Set the printing conditions in the [Print] dialog box on the computer.

Select the name of your printer under [Select Printer], and then enter the number of copies in the [Number of copies] field.

■ Example of the [Print] dialog box

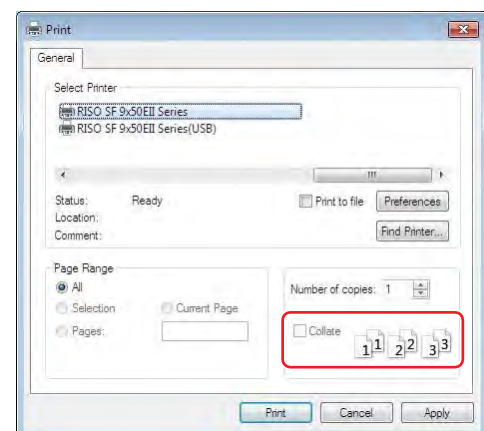

B Clear the [Collate] check box. If this check box is selected, master making is repeated each time a single copy is printed.

5 Perform the required settings in the [Printer Setup] ¹ screen.

Click [Preferences] ¹ in the [Print] dialog box, and then perform the following settings.

¹ The screen name and button name may vary depending on the application software that you use.

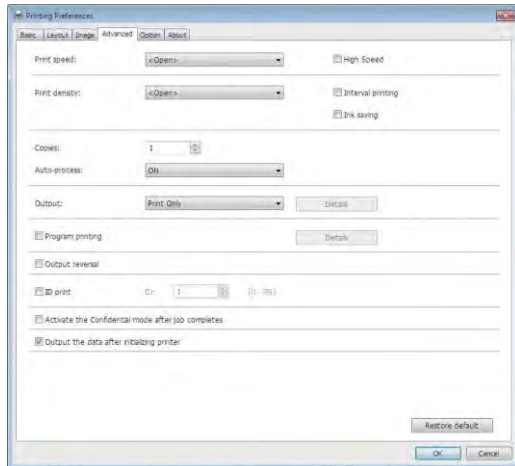

■ [Advanced] tab screen

[Auto Process]: Before master making and the printing process, you can temporarily stop the operation to check the proof copy, perform various settings, replace the paper, or do other necessary work.

[ID print]: This setting is useful for printing highly confidential originals.

■ Other printing settings

For more information, see the “RISO Printer Driver User’s Guide” (DVD-ROM).

6 Click [OK].

The [Print] dialog box is displayed.

7 Click [Print]. ²

The original data is printed according to the printer driver settings.

² The button name may vary depending on the application software that you use.

- When [Auto Process] is [ON]: Master making is followed by the printing process.
- When [Auto Process] is set to other than [ON]: Perform the necessary operation according to the settings. (A 35 “When [Auto Process] is set to other than [ON]”)



B When [ID print] is set in step 5, refer to the page below to perform the necessary operation.
(A 37 “When [ID print] is set”)

B An idling action (to ensure the ink usability and stability) may be automatically executed. You can change the setting in [Auto Idling] (A 116) under [Admin.].

When [Auto Process] is set to other than [ON]

The operation varies depending on the [Auto Process] setting that is selected in the printer driver.

■ When [Pause before “Master-making”] is selected

The operation pauses before master making of each page. After master making, the printing process is performed automatically.

1 Check that the master making basic screen is displayed.

If a screen other than the master making basic screen is displayed, press the [MASTER MAKING] key (A 21).



B When the [Job List] screen is displayed, go to step 3.

2 Touch [Pause].

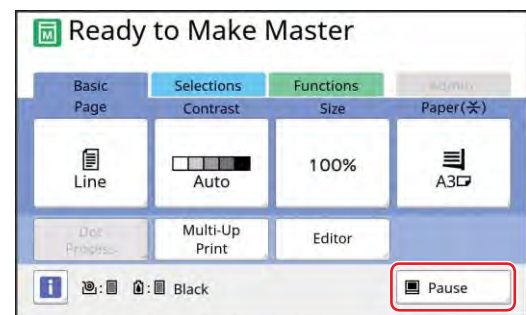

3 Touch [Output].

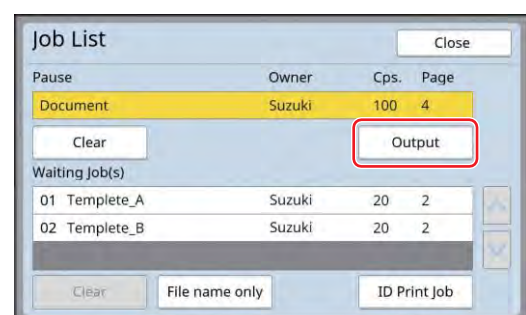

4 Check the master making conditions.

(A 22 “Touch Panel Displays”)

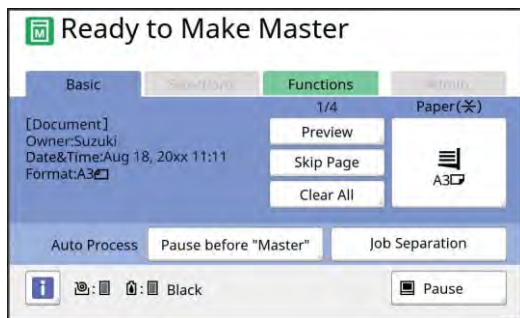

5 Press the [START] key.

After master making, the printing process starts. Operation does not pause after a proof copy has been output.

After the printing process is complete, the operation pauses and then master making of the next page starts. Repeat steps 4 to 5 for each page.

■ When [Pause before "Print"] is selected

After master making of each page is performed automatically, a proof copy is output, and then the operation pauses.

1 Check the printing conditions.

Check the printing position and density on the proof copy. Perform the required settings as necessary.

2 Press the [START] key.

The printing process starts. After the printing process is complete, master making of the next page starts. After outputting a proof copy, the operation pauses. Repeat steps 1 to 2 for each page.

■ When [OFF] is selected

Before the master making process and before the printing process of each page, the operation pauses.

1 Perform steps 1 to 3 in “When [Pause before "Master-making"] is selected”.

2 Check the master making conditions.

(A 22 “Touch Panel Displays”)

3 Press the [START] key.

Master making starts. After master making is complete, a proof copy is output and then the operation pauses.

4 Check the printing conditions.

Check the printing position and density on the proof copy. Perform the required settings as necessary.

5 Press the [START] key.

The printing process starts. After the printing process is complete, the operation pauses and then master making of the next page starts. Repeat steps 2 to 5 for each page.

When [ID print] is set

1 Check that the master making basic screen is displayed.

If a screen other than the master making basic screen is displayed, press the [MASTER MAKING] key (A 21).

 B When the [Job List] screen is displayed, go to step 3.

2 Touch [Pause].

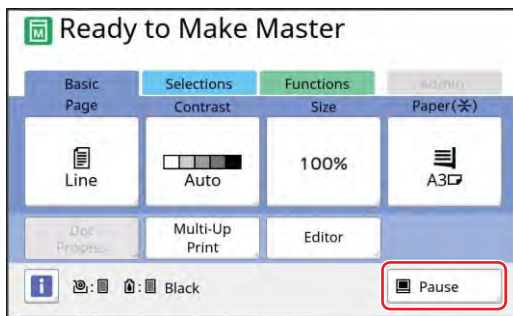

3 Touch [ID Print Job].

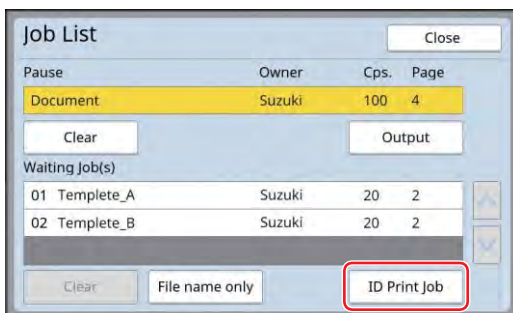

Perform job identification according to the instructions on the screen.

 B If there are only jobs set with [ID print], the screen in step 3 will not be displayed. Go to step 4.

4 Touch [Output].

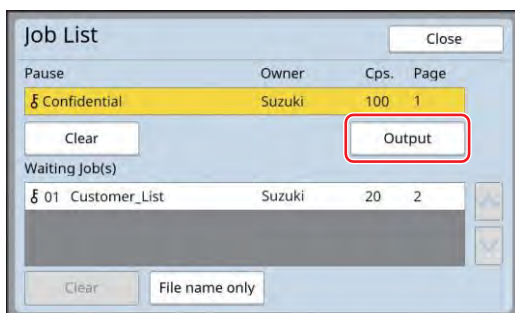

5 Check the master making conditions.

(A 22 "Touch Panel Displays")

6 Press the [START] key.

Printing starts.

- When [Auto Process] is [ON]:
Master making is followed by the printing process.
- When [Auto Process] is set to other than [ON]:
Perform the necessary operation according to the settings.

(A 35 "When [Auto Process] is set to other than [ON]")

Saving Paper Original as Data

Paper originals can be read with the scanner of this machine and the data can be saved in [Storage] or [USB].



[Storage]
A memory card installed in this machine

Once the original data is saved, the data can be used as follows:

- Printing the original data on this machine (A 40 “Printing the Saved Original Data”)
- Printing the original data that is overlaid on a paper original (A 68 “Overlaying Original Data on a Paper Original [Overlay]”)

! **To use [Storage], it is necessary to install a memory card in this machine.**

B **The original data that was saved uses the unique file format for this machine. You can use the original data on “RISO USB PRINT MANAGER”.**

B **When the optional RISO Controller IS300 is connected, the original data that is read in the scan mode is saved in the IS300. The data cannot be saved in [Storage] or [USB].**

Installing a memory card

To use [Storage], it is necessary to install a memory card in this machine.

Purchase a commercially available memory card.

You can use the following types of cards.

- SD card 
- SDHC card 

! **We do not provide any warranty covering damage to the data on the card that is caused by a natural disaster or unforeseen event. We recommend that you use your computer to make back-up copies of any important documents.**

1 Turn off the power to this machine.

Press the [Y] side of the power switch.

2 Remove the cover for the card slot.

Turn the thumbscrew by hand counterclockwise to loosen it.

Slide the cover to the left, and then remove the cover.

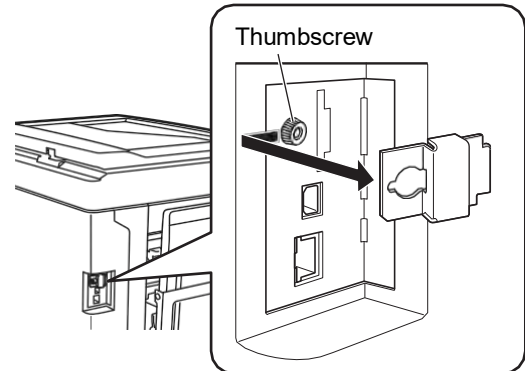

! **Do not loosen or remove any screws other than the screw that is specified in the figure.**

3 Insert the card into the slot.

Set the card in the direction that is shown in the figure and insert it until you hear a click sound.

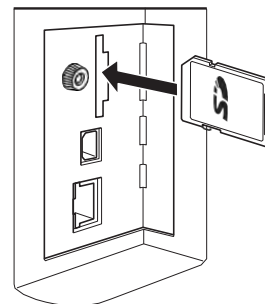

! **Be sure to insert the card into the correct direction. If the card is inserted in the wrong direction, the card may be damaged.**

B **Before inserting the card, remove its write protection.**

If there is a switch with a label such as “LOCK” on the side or back of the card, slide the switch to remove write protection.

4 Attach the cover.

Return the cover to its original position, and then turn the thumbscrew clockwise to tighten it.

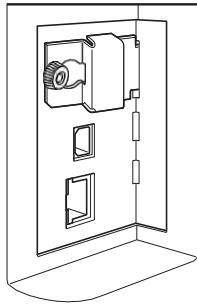

Removing the memory card

1 Push in the card until you hear a click sound.

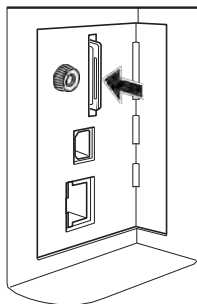

2 Slowly release your finger.

The card is ejected.
With your fingers, pinch and pull out the card.

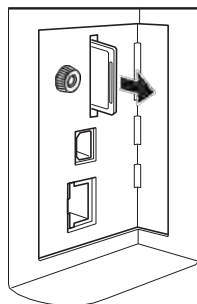

Scanning the paper originals

1 Switch to the scan mode.

In the [HOME] screen (A 22), touch [Scanning].

2 Set the information for the data to be saved.

- [File Name] (A 105)
- [Directory] (A 105)
- [Owner] (A 106)

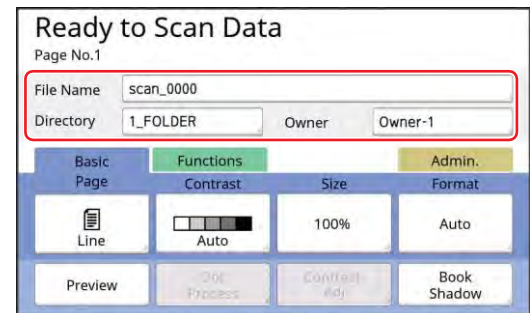

3 Place the original.

(A 31 "Placement of Originals")

4 Set the scanning conditions.

(A 104 "Functions for Scanning")

5 Press the [START] key.

Scanning of the original starts.
When there are multiple originals, repeat steps 3 to 5.



B When you place several originals on the optional auto document feeder at the same time, the same scanning conditions are applied to all of the originals.

6 Touch [Exit].

After completing scanning of the originals that you want to save as a single data set, touch [Exit].

A screen is displayed to confirm whether you want to save the original data.

7 Touch [Yes].

The original data is saved.



B To exit the scan mode, press the [HOME] key.

Printing the Saved Original Data

You can print the original data that is saved using the following methods.

- [Storage]: Original data that is saved in this machine
 - For the method to save data from paper originals, see the section below.
(A 38 “Saving Paper Original as Data”)
 - For the method to save data from a computer, see the “RISO Printer Driver User’s Guide” (DVD-ROM).
- [USB Job List]: Original data that is saved in a USB flash drive
 - For the method to save data from paper originals, see the section below.
(A 38 “Saving Paper Original as Data”)
 - For the method to save data from a computer, see the “RISO Printer Driver User’s Guide” (DVD-ROM).
- [USB print (Auto process)]: Original data that is saved in a USB flash drive using the printer driver (The data can be printed with minimum required steps.)
 - For the method to save data, see the “RISO Printer Driver User’s Guide” (DVD-ROM).

Printing from [Storage]

1 Turn on the power to this machine.

Press the [X] side of the power switch.



B When an authentication screen (A 22) is displayed, follow the instructions on the screen.

2 Check that the master making basic screen is displayed.

If a screen other than the master making basic screen is displayed, press the [MASTER MAKING] key (A 21).

3 Check the paper.

(A 28 “Setting up the paper feed tray and the paper”)

4 Check the paper receiving tray.

(A 29 “Setting up the paper receiving tray”)

5 Touch [Storage] in the [Functions] tab screen.

6 Touch the original data that you want to print.

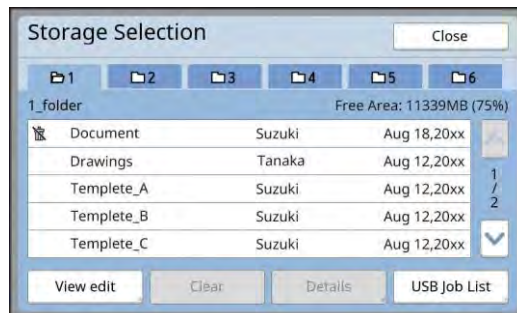

- To select original data that is saved in another folder, touch the folder tab.
- When there are 6 or more original data files, touch [For []] to change the list that is displayed.



B Depending on the type of original data, the following icon is displayed:
 Original data that is edited using the [Editor]

7 Touch [Details].

8 Check the original data to be printed.



B To manage the original data, see the page below.
(A 66 “Managing the Saved Original Data [Storage], [USB Job List]”)

9 Touch [Retrieve].

10 Check the [Auto Process] setting.

The settings that can be selected are the same for “Printing from Computer” (A 34).

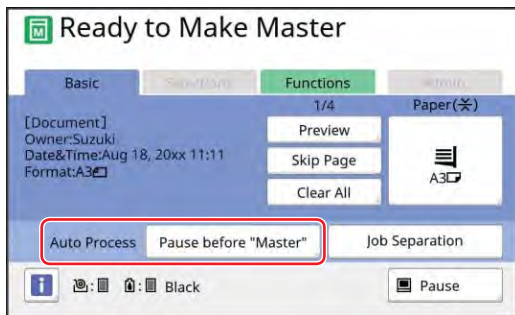

11 Perform other operations.

For the operation in the master making basic screen, see the following page. (A 22 “Touch Panel Displays”)

12 Enter the number of copies to be printed using the numeric keys.

13 Press the [START] key.

- When [Auto Process] is [ON]: Master making is followed by the printing process.
- When [Auto Process] is set to other than [ON]: Perform the necessary operation according to the settings. (A 35 “When [Auto Process] is set to other than [ON]”)



B An idling action (to ensure the ink usability and stability) may be automatically executed. You can change the setting in [Auto Idling] (A 116) under [Admin.].

Printing from [USB Job List]

You can print the original data that is saved in the USB flash drive by performing the settings shown below.

- In the printer driver dedicated for the USB flash drive printing, set [USB print (Manual)] for [Output:].



B You cannot print any original data (PDF file, etc.) that is saved with another method.

1

Make preparations for this machine.

Perform steps 1 to 4 in “Printing from [Storage]” (A 40).

2

Insert the USB flash drive that contains the original data into the USB port.

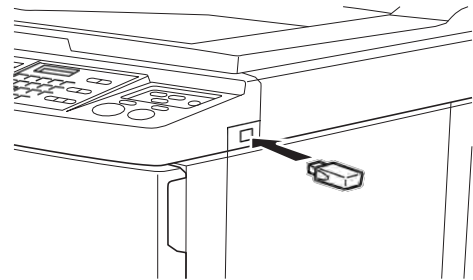

B Do not remove the USB flash drive until the printing is completed. It might cause loss of data and settings or damage to the USB flash drive.

3

Touch the original data that you want to print.

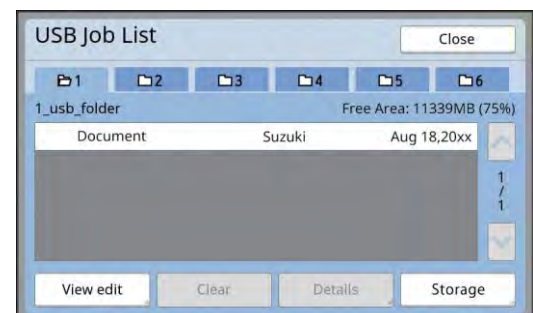

- To select original data that is saved in another folder, touch the folder tab.
- When there are 6 or more original data files, touch [F] or [G] to change the display.



B If the [USB Job List] screen does not appear automatically, touch [USB Job List] in the [Functions] tab screen.

4 Touch [Details].

5 Check the original data to be printed.



B To manage the original data, see the page below.
(A 66 “Managing the Saved Original Data [Storage], [USB Job List]”)

6 Touch [Retrieve].

Follow steps 10 to 13 in “Printing from [Storage]” for the rest of the procedure.

Printing from [USB print (Auto process)]

You can print the original data that is saved in the USB flash drive by performing the settings shown below.

- In the printer driver dedicated for the USB flash drive printing, set [USB print (Auto process)] for [Output:].



B You cannot print any original data (PDF file, etc.) that is saved with another method.

1

Make preparations for this machine.

Perform steps 1 to 4 in “Printing from [Storage]” (A 40).

2

Insert the USB flash drive that contains the original data into the USB slot.

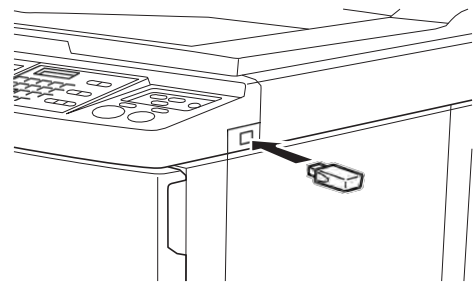

- When [Auto Process] is [ON]:
Master making is followed by the printing process.
- When [Auto Process] is set to other than [ON]:
Perform the necessary operation according to the settings.
(A 35 “When [Auto Process] is set to other than [ON]”)



B Do not remove the USB flash drive until the printing is completed.
It might cause loss of data and settings or damage to the USB flash drive.



B After master making, the original data in the USB flash drive is erased automatically.

3

Remove the USB flash drive.

When printing is complete, remove the USB flash drive.

How to print the ID data

The following types of original data are referred to as "ID data".

- Original data with [ID Print] set in the scan mode (A 38 "Saving Paper Original as Data")
- Original data with [ID print] set in the printer driver For the setting procedure, see the "RISO Printer Driver User's Guide" (DVD-ROM).

Follow the steps below to display ID data in the [Storage Selection] screen or the [USB Job List] screen.

1 Touch [View edit].

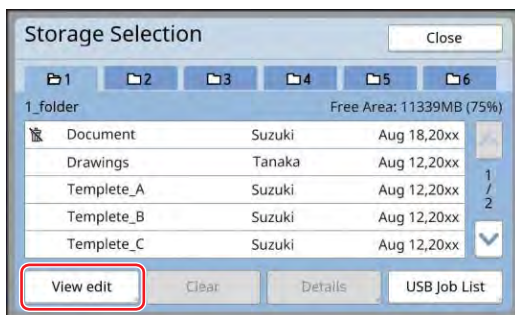

2 Touch [ID Print Job].

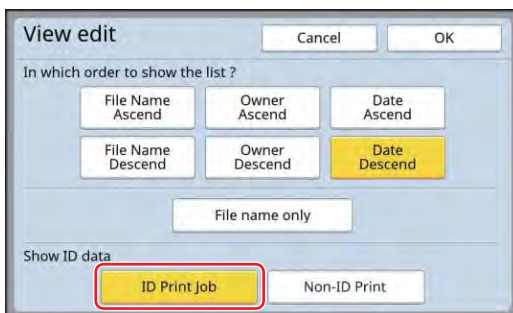

- B [Show ID data] is displayed when [High/Full Management] or [Mid/ID Print Only] is set in [User Management] (A 122) under [Admin.].

3 Touch [OK].

The ID data is displayed in the [Storage Selection] screen or the [USB Job List] screen.

- A [I] (key mark) icon is displayed on the tab buttons.
- To display original data other than ID data, touch [Non-ID Print].

The subsequent operations are the same as steps 6 (A 40) and later in "Printing from [Storage]".

Performing authentication before using this machine

"Authentication" refers to identifying this machine's users using the PIN code assigned to each user. Identifying users enhances the management capability and security level for each user.

Performing authentication operation

In this case, you will need to perform the authentication operation in order to use this machine. The following three methods are available to perform the authentication operation. The method to use is specified in [Recognized by] (A 122) of [Admin.].

■ Entering the PIN code



1 Enter the PIN code using the numeric keys.

The entered code digits are displayed as "j".

- B You can select [Admin.] - [Create User] to confirm or change the PIN code.

2 Touch [OK].

When the authentication screen disappears, this machine can be used.

■ Using a USB flash drive



1 Insert the registered USB flash drive into the USB slot.

When the authentication screen disappears, this machine can be used.

Remove the USB flash drive from the USB slot. The authentication status remains even after the USB flash drive has been removed.



B You will need to register the USB flash drive for authentication purposes on this machine in advance. (A 124 “[Create User]”)

In the authentication status, the [WAKE-UP] key (A 21) is lit even when the machine is not in sleep mode. If you press the [WAKE-UP] key in this status, authentication is released.



B The authentication status is automatically released after the specified time in [Auto Clear] (A 115) or [Auto Sleep] (A 115) has elapsed.

■ Using the IC card reader (option)



1 Touch the IC card reader with the registered IC card.

When the authentication screen disappears, this machine can be used.

Remove the IC card from the IC card reader. The authentication status remains even after the IC card is removed from the IC card reader.



B You will need to register the IC card for authentication purposes on this machine in advance. (A 124 “[Create User]”)

Releasing the authentication status

The status in which this machine has identified the user after the authentication operation succeeds is referred to as “authentication status”.

After using this machine, release the authentication status.



B If the authentication status is not released, this machine will become available to other users.

1 Press the [WAKE-UP] key that is lit.





Chapter **3**

3

Functions for Master Making

Functions for Master Making

For the details and setting procedure of each function, see the pages that are specified as a reference.

■ Functions related to image processing

[Image] (A 47)

You can set the processing that is suitable for the type of original.

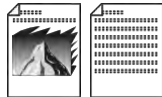

[Dot Process] (A 49)

You can set the processing method to express the gradation of a photo.

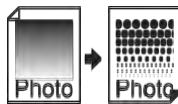

[Contrast Adj] (A 49)

You can change a blurry photo to a sharp final output.

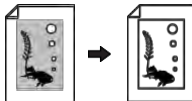

[Tone Curve] (A 50)

You can adjust the tone of bright parts and dark parts in originals such as a photo.



[Contrast] (A 50)

You can adjust the contrast according to the paper color and the tint of the original.

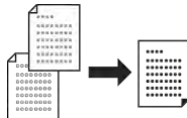

[Book Shadow] (A 51)

You can erase or reduce the shadow in the binding section of books.

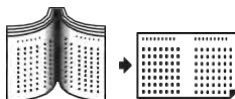

[Ink Saving] (A 52)

You can reduce the amount of ink consumption.

[Quick Master Making] (A 53)

You can shorten the time required for master making.

■ Functions related to layout

[Size] (A 53)

You can enlarge or reduce the size of the original.

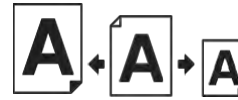

[Paper Size] (A 55)

You can select a custom paper size.



[Max. Scan] (A 56)

You can make a master using the maximum printing area.

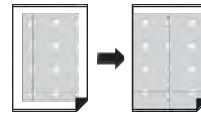

[Multi-Up Print] (A 56)

You can lay out multiple originals on a single sheet of paper.

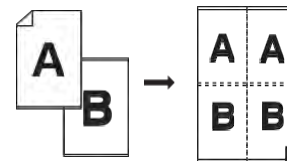

[2 Up] (A 60)

You can lay out two copies of an original side by side on a single sheet of paper.

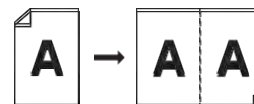

[Top Margin Adj.] (A 61)

You can cut (trim) the top section of the original.

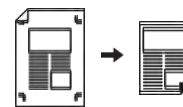

[Binding Margin Adj.] (A 62)

You can adjust the vertical print position for master making.

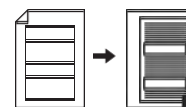

■ Other functions

[Preview] (A 63)

You can check the final image before performing master making.

[ADF Semi-Auto] (A 64)

Master making is automatically performed for originals that are set in the auto document feeder. (The optional auto document feeder must be installed.)

[Paper Memory Print] (A 64)

Even if this machine cannot be connected to a computer, you can still perform high-resolution printing similar to printing that is performed directly from a computer.

[Storage], [USB Job List] (A 66)

You can use the original data that is saved in this machine or a USB flash drive.

[Overlay] (A 68)

You can overlay the original data that is saved in [Storage] or [USB Job List] on a paper original.



Image Processing That Is Suitable for the Original [Image]

You can obtain clearer images by selecting processing that is suitable for the type of original.



BYou can change the default setting in [Image Processing] (A 112) under [Admin.].

1 Touch [Page] in the [Basic] tab screen.

2 Select the type of original.

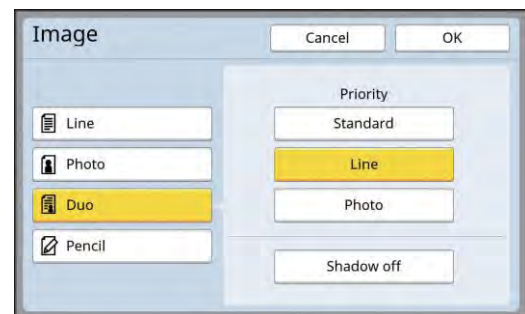

■ [Line]

Select this option for originals that do not contain photos. It is suitable for clearly expressing characters, or pictures with unvarying tint.



BYou cannot use this function with the following functions.

C[Dot Process] (A 49)

C[Contrast Adj] (A 49)

C[Tone Curve] (A 50)

■ [Photo]

Select this option when clearness of photos is important.



BYou cannot use this option with [Auto] under [Contrast] (A 50).

BYou can change the processing method to express the gradation of a photo in [Dot Process] (A 49).

BYou can change a blurry photo to a sharp final output in [Contrast Adj] (A 49).

BYou can adjust the tone of the bright parts and dark parts in a photo in [Tone Curve] (A 50).

■ [Duo]

Select this option when you want clearness of both characters and photos.



B You cannot use this function with the following functions.

- C[Auto] under [Contrast] (A 50)
- C[Contrast Adj] (A 49)

B You can change the processing method to express the gradation of a photo in [Dot Process] (A 49).

B You can adjust the tone of the bright parts and dark parts in a photo in [Tone Curve] (A 50).

■ [Pencil]

Select this option for originals that are pale in color such as an original written in pencil or stamped in red seal-ink.



B You cannot use this function with the following functions.

- C[Dot Process] (A 49)
- C[Auto] under [Contrast] (A 50)
- C[Contrast Adj] (A 49)

B You can adjust the tone of the bright parts and dark parts in a photo in [Tone Curve] (A 50).

3 Select a specific type.

If you have selected a type other than [Line], select a more specific type.

■ For [Photo]

Type	Description
[Standard]	Select this option when the condition for [Portrait] below does not apply to the original.
[Portrait]	Select this option for photos that show the upper half of the body of up to two persons. (The image is processed so that the faces are especially printed clearly.)

■ For [Duo]

Type	Description
[Standard]	Select this option when you want to reproduce characters and photos with good balance. This option is also suitable for colored originals.
[Line]	Select this option to emphasize the clearness of characters. This is also suitable when the original contains a photo with clear contrast, such as buildings and gloss on metallic surfaces.
[Photo]	Select this option when the original contains a photo in which smoothness of gradation is important, such as food and portrait photos.
[Shadow off]	Select this option to clear the background color of the dark-colored originals, such as newspapers. [Shadow off] is selectable aside from other options.

■ For [Pencil]

Type	Description
[Darker]	Select this option to clarify light characters.
[Lighter]	Select this option to clarify light characters but reduce shadows in a cut-and-paste original.

4 Touch [OK].

Selecting a Method to Process the Gradation of Photos [Dot Process]

You can set the processing method to express the gradation of a photo.



[Dot Process] can be selected only when [Photo] or [Duo] has been set for [Image] (A 47).

- 1 Touch [Dot Process] in the [Functions] tab screen.
- 2 Touch a target setting button.

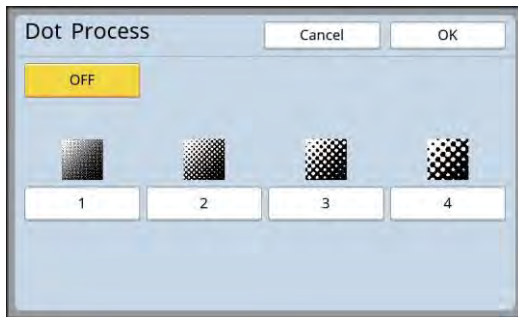

■ [OFF]

Gradation of photos is processed by an error diffusion method.

The gradation is expressed by changing the density of dots that are irregularly arranged.

■ [1] to [4]

Gradation of photos is processed by a dot process method.

The gradation is expressed by changing the size of dots that are regularly arranged.

You can select the pattern of the screen ruling (the number of dots per inch). The higher the screen ruling, the finer the arrangement of dots, which allows for smooth expression of the gradation.

[1]: Equivalent to 106 lines

[2]: Equivalent to 71 lines

[3]: Equivalent to 53 lines

[4]: Equivalent to 34 lines

- 3 Touch [OK].

Adjusting the Darkness and Lightness of Photos [Contrast Adj]

You can change a blurry photo to a sharp final output.



[Contrast Adj] can be selected only when [Photo] has been set for [Image] (A 47).

- 1 Touch [Contrast Adj] in the [Functions] tab screen.
- 2 Touch a target setting button.



■ [OFF]

The [Contrast Adj] processing is not performed.

■ [Lighter]

Darker parts are expressed more clearly. Select this option when a dark object is not clearly seen in an overall dark photo.

■ [Darker]

Lighter parts are expressed more clearly. Select this option when a bright object is not clearly seen in an overall bright photo.

- 3 Touch [OK].

Adjusting the Gradation of Photos [Tone Curve]

You can adjust the tone of the bright parts and dark parts in a photo in incremental levels.



B[Tone Curve] can only be selected when a setting other than [Line] is specified for [Image] (A 47).

1 Touch [Tone Curve] in the [Functions] tab screen.

2 Touch a target setting button.

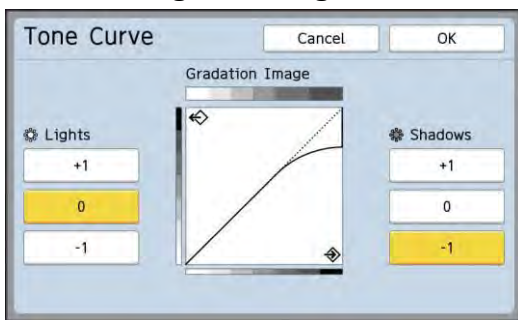

■ [Lights]

You can adjust the expression of the bright parts in the photo.

Setting	Description
[+1]	Reduces the range that is expressed in bright colors. The fine parts within the bright range becomes more visible.
[0]	Applies standard processing.
[-1]	Enlarges the range that is expressed in bright colors. Some fine parts within the bright range may not be visible.

■ [Shadows]

You can adjust the expression of the dark parts in the photo.

Setting	Description
[+1]	Enlarges the range that is expressed in dark colors. Some fine parts within the dark range may be blurred.
[0]	Applies standard processing.
[-1]	Reduces the range that is expressed in dark colors. The fine parts within the dark range becomes more visible.

3 Touch [OK].

Adjusting the Contrast of the Original [Contrast]

You can adjust the contrast according to the conditions such as the paper color and the tint of the original.



BYou can change the default setting in [Scanning Contrast] (A 112) under [Admin.].

BThe [Contrast] setting cannot be changed when [Ink Saving] (A 52) is turned on.

1 Touch [Contrast] in the [Basic] tab screen.

2 Touch a target setting button.



■ [Auto]

You can select this button only when [Line] is selected in [Image] (A 47). When you select [Auto], the contrast is adjusted optimally according to the paper color of the original.

■ [1] to [5]

You can adjust the scanning density in five levels. Select [1] for the lowest density. Select [5] for the highest density.

3 Touch [OK].

Using a Book Type Original [Book Shadow]

When you scan an original that is bound at the center, such as a book, it is possible to erase or reduce the shadow of the binding section.

- !** Be sure to align the original to the center along the left side of the glass platen and place the original in the direction shown below.

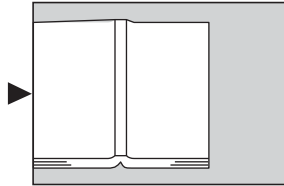

- B**When a gauge cover is attached on the glass platen, remove it. If you use [Book Shadow] with the gauge cover attached, the area around the original will be black in the master that is made.

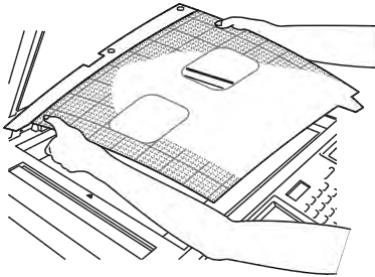

- B**When scanning a thick book, raise the hinges of the platen cover so that you can press the book evenly using the cover.

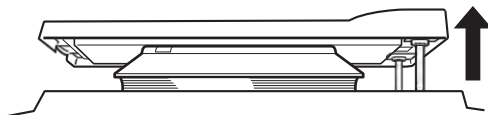

- B**You cannot use this function with the following functions.

- C[Binding Margin Adj.] (A 62)
- C[Ink Saving] (A 52)
- C[Auto] under [Contrast] (A 50)
- C[Multi-Up Print] (A 56)
- C[2 Up] (A 60)
- C[Quick Master Making] (A 53)

1 Touch [Book Shadow] in the [Functions] tab screen.

2 Select a processing method.

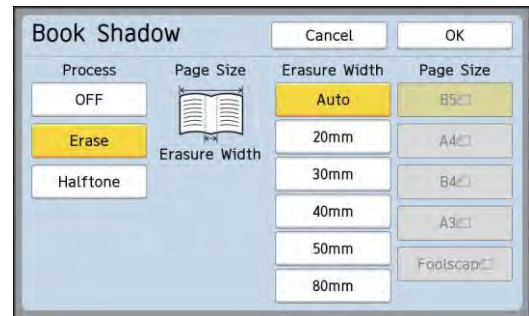

■ [OFF]

The [Book Shadow] processing is not performed.

■ [Erase]

Erases the shadow of the binding section and the shadow generated around the original.

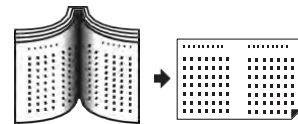

■ [Halftone]

Reduces the shadow of binding section using halftone processing and erases the shadow generated around the original.

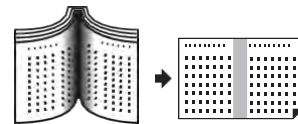

3 Select an erasure width.

■ [Auto]

Detects the binding section automatically and calculates an erasure width.

! When you select [Auto], the following image parts are also erased or processed in the half-tone.

C A black image extending from the area around the original

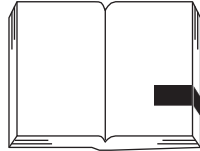

C A black image extending from the binding section

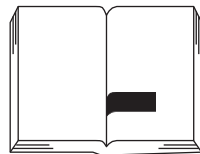

■ [20mm] to [80mm] ([3/4"] to [3 1/8"])

You can select these buttons only when [Erase] has been selected.

! When you select a button other than [Auto], the shadow generated around the original is not erased.

4 Select an original size.

If you selected a button other than [Auto] for [Erasure Width], select a size with the original book open. The center part of the selected [Page Size] is erased.

5 Touch [OK].

Saving Ink [Ink Saving]

By turning on [Ink Saving] when making a master, you can reduce the amount of ink consumption during printing.

! When [Ink Saving] is turned on, the print density becomes lower.

B Even if you change the [Ink Saving] setting during the printing process, the new setting is not applied to the master that has already been made and loaded on the print drum (cylinder). The changed [Ink Saving] setting is used for the next master making.



B You cannot use this function with the following functions.

- C[Contrast] (A 50)
- C[Print Density] (A 73)
- C[Book Shadow] (A 51)
- C[Preview] (A 63)
- C[Overlay] (A 68)

B When printing using the print drum on which a master is made by setting [Ink Saving] to ON, you will not be able to reconfigure the following functions.

- C[DENSITY] (A 73)

1 Touch [Ink Saving] in the [Functions] tab screen.



When [Ink Saving] is turned on, the [Ink Saving] icon is displayed in the message area.

! If the machine is changed to master making mode after printing, [Ink Saving] will be set to OFF the next time a master is made. To set [Ink Saving] to ON, touch [Ink Saving] again.

Shortening the Master Making Time [Quick Master Making]

You can shorten the time required for master making.

! When master making is performed with [Quick Master Making] turned on, an image is printed at 600 dpi × 400 dpi.

! You can change the default setting in [Quick Master Making] (A 113) under [Admin.].

You cannot use this function with the following functions.

- C[Size] (A 53)
- C[Multi-Up Print] (A 56)
- C[2 Up] (A 60)
- C[Book Shadow] (A 51)
- C[Binding Margin Adj.] (A 62)
- C[Preview] (A 63)
- C[Editor]
- C[Paper Memory Print] (A 64)
- C[Storage] (A 66)
- C[USB Job List] (A 66)
- C[Overlay] (A 68)

1 Touch [Quick Master Making] in the [Functions] tab screen.

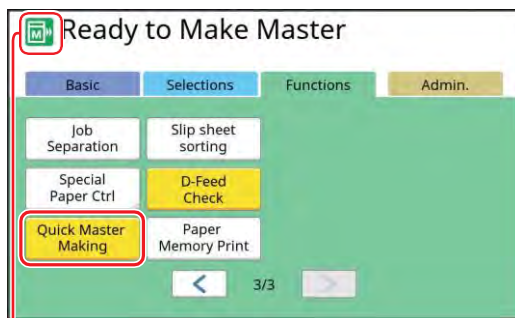

When [Quick Master Making] is turned on, the icon in the message area is changed.

[Quick Master Making]	Icon
OFF	
ON	

Enlarging or Reducing the Size of the Original [Size]

You can scan an original so that it is enlarged or reduced in size.

! Image parts outside the range for master making are not printed. (A 16 "Master making area")

! You can change the default setting in [Reproduction Size] (A 112) under [Admin.].

You can change the reduction rate for [Margin+] in [Margin-Plus Rate] (A 114) under [Admin.].

You cannot use this function with the following function.

C[Quick Master Making] (A 53)

The size setting method can be selected from the following three options.

- [Standard ratio]: You can set the size of the original simply by selecting a magnification rate.
- [Free]: You can set any magnification rates in the horizontal and vertical directions.
- [Zoom]: You can set any magnification rate without changing the zoom ratio in both the vertical and horizontal directions.

3

[Standard ratio]

1 Touch [Size] in the [Basic] tab screen.

2 Touch a target magnification rate.

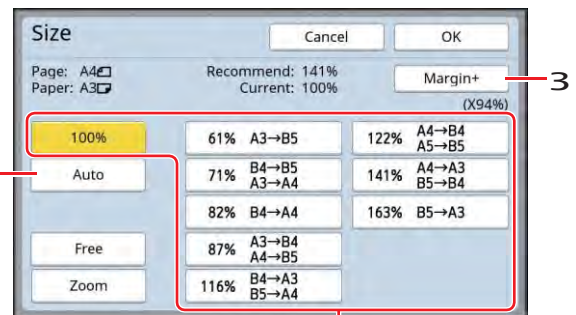

1 [Auto]: The size of the original is automatically enlarged or reduced according to the size of the paper on the paper feed tray. This option can be used only when the original is set on the auto document feeder, and both the original and the paper are a standard size.

- 2 [Standard ratio]: You can select one of the typical rates to enlarge or reduce originals from a standard size to another standard size.
- 3 [Margin+]: In addition to the selected magnification rate, a reduction rate is applied to create margins around the original.

 **B**[Margin+] cannot be selected when you have selected [Auto], [Free], or [Zoom].

B[Auto] under [Size] cannot be used when you have set [Multi-Up Print] (A 56) or [2 Up] (A 60).

3 Touch [OK].

[Free]

1 Touch [Size] in the [Basic] tab screen.

2 Touch [Free].

3 Change the magnification rate.

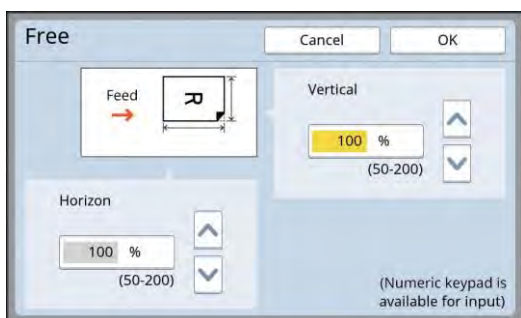

You can change the magnification rate using either of the following methods.

- Entering a numeric value using the numeric keys.
- Touching [F] or [G].

 **B**Pressing the [C] key returns the magnification rate to [100%].

4 Touch [OK].

[Zoom]

1 Touch [Size] in the [Basic] tab screen.

2 Touch [Zoom].

3 Change the magnification rate.

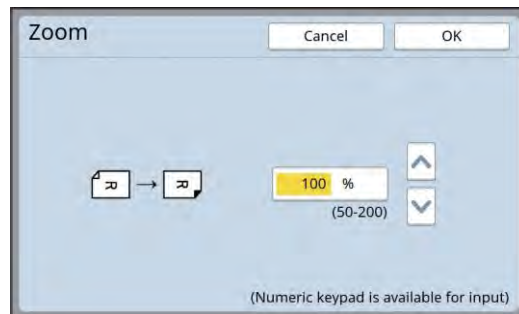

You can change the magnification rate using either of the following methods.

- Entering a numeric value using the numeric keys.
- Touching [F] or [G].

 **B**Pressing the [C] key returns the magnification rate to [100%].

4 Touch [OK].

Using Custom Size Paper [Paper Size]

When standard size paper (A 14) is set on the paper feed tray, this machine automatically detects the paper size and makes a master in an appropriate range for master making (A 16). However, when custom size paper is set, the paper size is not detected automatically. You need to select an appropriate paper size for [Paper Size] before master making.



If you use custom size paper while [Auto] is selected for [Paper Size], the printed image may be missing or the print drum (cylinder) may be stained.



The paper size to be used must have been registered in [Custom Paper Entry] (A 119) under [Admin.].

1 Touch [Paper] in the [Basic] tab screen.

2 Touch a target paper button.

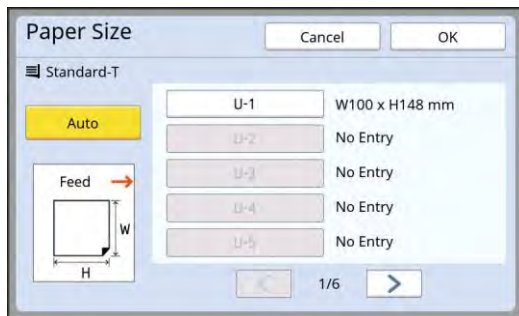

When using standard size paper, select [Auto].

3 Touch [OK].

■ When using extended paper (banner, etc.)

Paper that has an [H] (horizontal) length of 436 to 555 mm (17 5/32 to 21 27/32 inches) is called “extended paper”.

When you select an extended paper in the [Paper Size] screen, this machine runs in extended paper mode.

- In extended paper mode, the timing and speed of printing are different from the normal printing process.
- In extended paper mode, [<Ext.Paper>] is indicated in the message area.



To use extended paper, the optional Wide Stacking Tray is required. For the procedures to set the paper feed tray and the paper receiving tray, consult your dealer or authorized service representative.

Some types of paper cannot be fed into this machine, and some parts of the printed paper may be stained depending on the position of the printed image. For more information, consult your dealer or authorized service representative.

Minimizing Margins [Max. Scan]

This machine limits the master making range so that margins are applied inside the paper size. This feature is provided to prevent the rollers in this machine from being stained with ink and to prevent the occurrence of a paper jam.

When [Max. Scan] is turned on, the master making range is not limited according to the paper size and you can make a master in [Maximum printing area] (A 16) of this machine.

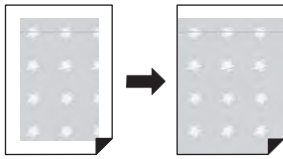

! Even if you turn on [Max. Scan], the range of 5 mm (3/16 inches) from the leading edge of the paper is not used for master making.

1 Touch [Max. Scan] in the [Functions] tab screen.

! Before performing master making, check that the platen cover pad and entire area of the glass platen is not stained. Even a stain that is located outside the original may cause the rollers in this machine to be stained with ink as this stain is also included in the master to be made.

B Tightly close the platen cover during master making. If there is a gap under the platen cover, the shadow of the original is included in the master, causing the rollers in this machine to be stained with ink.

B Do not use paper that is smaller than the image for which a master has been made. The rollers in this machine will be stained with ink and those stains will be transferred to the back surface of the paper in the subsequent printing.

Laying Out Multiple Originals on a Single Sheet of Paper [Multi-Up Print]

The process for laying out multiple originals on a single sheet of paper is referred to as [Multi-Up Print]. This feature is useful in a situation where you want to save paper, or print messages and memos.



B You cannot use this function with the following functions.

- C[Book Shadow] (A 51)
- C[Top Margin Adj.] (A 61)
- C[Binding Margin Adj.] (A 62)
- C[Quick Master Making] (A 53)
- C[Auto] under [Format] (A 107)

■ [Single-Original]

Lays out multiple copies of one original on a single sheet of paper.

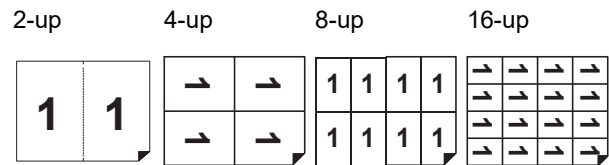

■ [Multiple-Original]

Lays out multiple copies of two or four originals on a single sheet of paper.

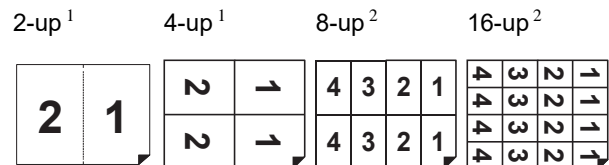

¹ Two originals can be laid out.
² Four originals can be laid out.

■ [Multi-Up Tickets]

Lays out multiple copies of a thin original, such as a ticket, on a single sheet of paper.



[Single-Original], [Multiple-Original]

1 Place an original.

The direction for placing the original varies depending on the number of copies of original to be laid out on a single sheet of paper.

For 2-up and 8-up printing:

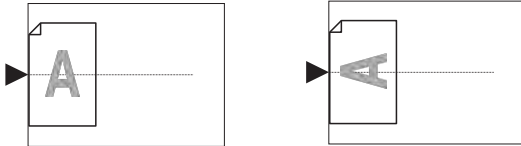

For 4-up and 16-up printing:

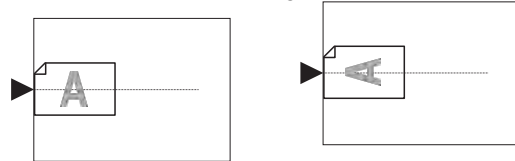

! **B** The glass platen cannot be used with the optional auto document feeder. If you place the first original on the glass platen, place the rest of the originals on the glass platen too.

2 Place the paper.

Place the paper in the direction of a short edge paper feed.

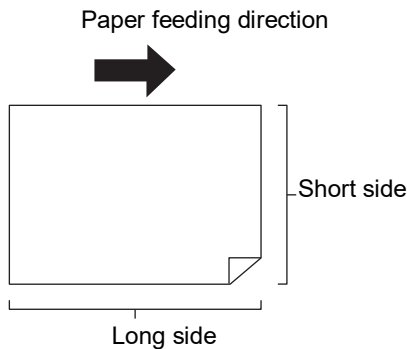

! **B** Use a standard size of paper. You cannot use custom size paper or paper sizes that are registered in [Admin.].

3 Set the paper receiving tray.

(A 29 "Setting up the paper receiving tray")

4 Check that the master making basic screen is displayed.

If a screen other than the master making basic screen is displayed, press the [MASTER MAKING] key (A 21).

5 Touch [Multi-Up Print] in the [Functions] tab screen.

6 Touch an original size.



! **B** For 4-up and 16-up printing, touch an original size button that shows a  symbol.

 **B** The magnification rate is automatically calculated using the selected original size and the size of the paper that is placed. If the magnification rate is out of the range between 50 and 200%, the combination of the original and paper sizes cannot be used.

7 Touch [Next].

8 Touch [Single] or [Multiple].

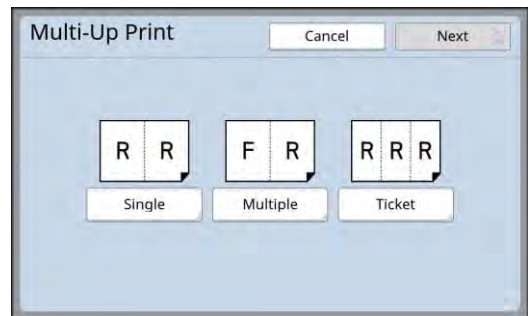

9 Touch [Next].

10 Touch the number of copies to be laid out on a single sheet of paper.

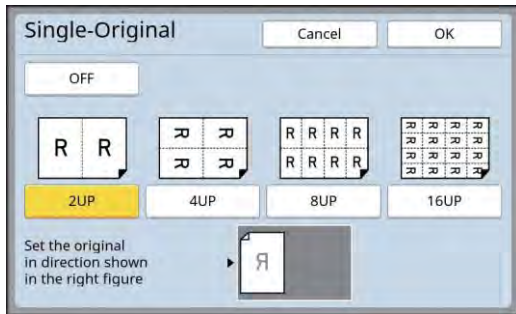

B Check that the original is placed in the direction shown at the bottom of the screen.

11 Touch [OK].

12 Set the other required printing conditions.

(A 46 “Functions for Master Making”)

B To cancel [Multi-Up Print], perform step 5 again and display the setting screen. Touch [OFF] and then [OK].

13 Press the [START] key.

Scanning of the original starts. The rest of the procedure is the same as the normal printing operation of paper originals. (A 33 “Printing of Paper Originals”)

If a message that asks you to place the next original is displayed, place the original that is to be scanned next, and then press the [START] key.

B If a certain amount of time has elapsed without the next original being placed, master making starts automatically. The range that has not been scanned is output as a blank space. This certain amount of time is referred to as [Multi-Up Interval]. The factory default is 15 seconds. You can change the interval in [Multi-Up Interval] (A 115) under [Admin.].

[Multi-Up Tickets]

The number of copies to be laid out on a single sheet of paper is determined automatically simply by specifying the short side size (width) of the original.

The number of copies is calculated by dividing the long side size of the paper by the short side size of the original. The remaining area is output as a blank space.

The width of the original can be specified between 50 mm and 210 mm (2 inches and 8 1/4 inches). Note that a margin of 5 mm (3/16 inches) or more is required around the original.

Example:

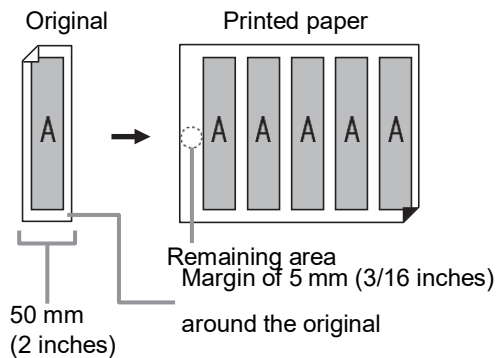

Short side of the original: 50 mm (2 inches)
 Long side of the paper: 297 mm (11 11/16 inches) (A4 size)
 $297 / 50 = 5$ remainder 47
 Five copies of the original are laid out on a single sheet of paper and the remaining area will be a blank space.

1 Placement of Originals

Place an original on the glass platen.

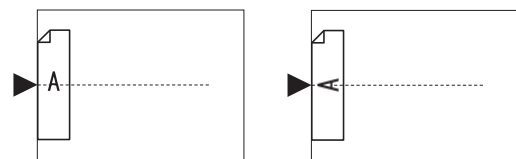

- 2 Place the paper.**
Place the paper in the direction of a short edge paper feed.

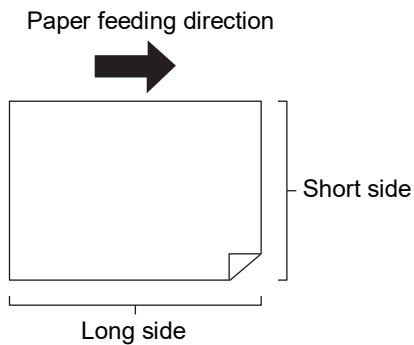

- !** Use a standard size of paper. You cannot use custom size paper or paper that are registered in [Admin.].
- B** When you set [Size] in step 13 of the printing condition setting, place the paper that is appropriate for the original size after it has been enlarge or reduced.

- 3 Set the paper receiving tray.**
(A 29 "Setting up the paper receiving tray")

- 4 Check that the master making basic screen is displayed.**
If a screen other than the master making basic screen is displayed, press the [MASTER MAKING] key (A 21).

- 5 Touch [Multi-Up Print] in the [Functions] tab screen.**

- 6 Touch any size.**
The selected size has no effect in multi-up tickets.



- 7 Touch [Next].**

- 8 Touch [Ticket].**

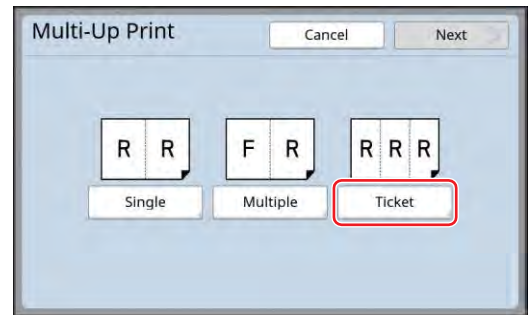

- 9 Touch [Next].**

- 10 Touch [ON].**

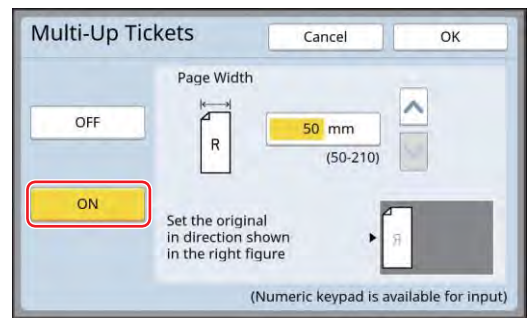

- 11 Specify the short side length (width) of the original.**

You can specify the short side length using either of the following methods.

- Entering a numeric value using the numeric keys.
- Touching [F] or [G].

- !** When you set [Size] in step 13 of the printing condition setting, specify the size of the original after it has been enlarged or reduced.

B Pressing the [C] key returns the length to [50mm] ([2.0"]).

- 12 Touch [OK].**

- 13 Set the other required master making conditions.**

(A 46 "Functions for Master Making")
(A 84 "Useful Functions")



B To cancel [Multi-Up Print], perform step 5 again and display the setting screen. Touch [OFF] and then [OK].

14 Press the [START] key.

Scanning of the original starts.

The rest of the procedure is the same as the normal printing operation of paper originals. (A 33 “Printing of Paper Originals”)

One-Touch Operation for 2-Up Printing [2 Up]

The process for laying out multiple originals on a single sheet of paper is referred to as [Multi-Up Print].

The [2 Up] function enables 2-up printing (laying out two copies of an original side by side) of [Multi-Up Print] (A 56) to be performed with fewer steps.



B You cannot use this function with the following functions.

C[Book Shadow] (A 51)

C[Top Margin Adj.] (A 61)

C[Binding Margin Adj.] (A 62)

C[Quick Master Making] (A 53)

C[Auto] under [Format] (A 107)

Final images

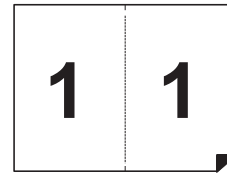

1 Placement of Originals

Place an original in the direction shown below.

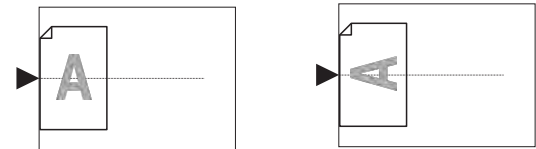

2 Place the paper.

Place the paper in the direction of a short edge paper feed.

Paper feeding direction

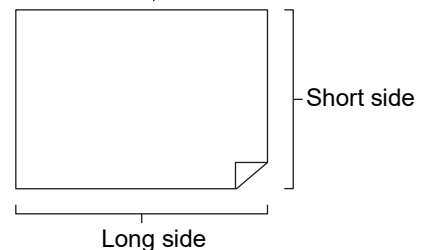

B Use a standard size of paper. You cannot use custom size paper or paper that are registered in [Admin.].

3 Set the paper receiving tray.

(A 29 “Setting up the paper receiving tray”)

4 Check that the master making basic screen is displayed.

If a screen other than the master making basic screen is displayed, press the [MASTER MAKING] key (A 21).

5 Touch [2 Up] in the [Functions] tab screen.

6 Set the other required master making conditions.

(A 46 “Functions for Master Making”)

(A 84 “Useful Functions”)



B The reduction and enlargement rates are different from the standard magnification rates. Specify a magnification rate that is shown in the tables below.

		Original			
		A4	B5	A5	B6
Printing Paper	A3	100%	116%	141%	163%
	B4	87%	100%	122%	141%
	A4	71%	82%	100%	116%
	B5	61%	71%	87%	100%

		Original			
		A6	B7	A7	B8
Printing Paper	A3	200%	-	-	-
	B4	173%	200%	-	-
	A4	138%	163%	200%	-
	B5	122%	141%	173%	200%

		Original	
		Letter	Statement
Printing Paper	Ledger	100%	127%
	Legal	77%	100%
	Letter	66%	100%
	Statement	50%	66%

7 Press the [START] key.

Scanning of the original starts. The rest of the procedure is the same as the normal printing operation of paper originals. (A 33 “Printing of Paper Originals”)

Cutting the Top Section of the Original [Top Margin Adj.]

You can cut (trim) the top section of the original.

For example, when using an original that contains register marks, turn on [Top Margin Adj.] to cut off the margin from the top of the original to the register marks. Then, print on the paper that has the same size as the area enclosed by the register marks. You can obtain a printed result with the area outside the register marks omitted.

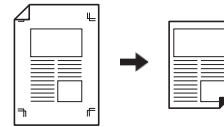

B You cannot use this function with the following functions.

C[Multi-Up Print] (A 56)

C[2 Up] (A 60)

C[Paper Memory Print] (A 64)

C[Overlay] (A 68)

1 Touch [Top Margin Adj.] in the [Functions] tab screen.

2 Touch [ON].

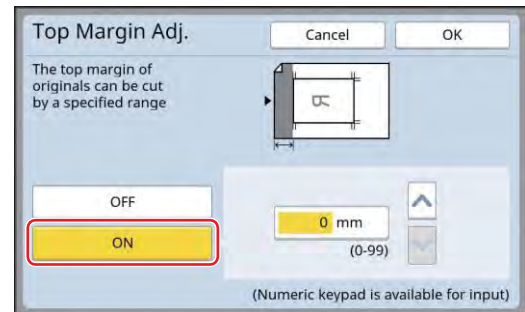

3 Specify the width to be cut.

You can specify the width to be cut using either of the following methods.

- Entering a numeric value using the numeric keys.
- Touching [F] or [G].



B Pressing the [C] key returns the length to [0 mm] ([0.0 inches]).

4 Touch [OK].

Adjusting the Master Making Position [Binding Margin Adj.]

You can adjust the master making position, for example, when you want to extend a margin to bind the printed paper.

Select either the left or right side (when facing in the paper feeding direction) where you want to extend the margin, and then specify the length to shift.

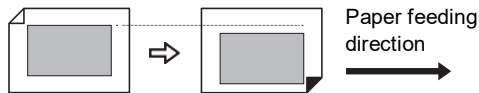

If you place multiple originals on the optional auto document feeder, you can perform master making for all originals with the master making position shifted in the vertical direction.

! If there is insufficient margin for an original and you shift the master making position to extend the margin on one side, some images may be missing on the other side.

B You cannot use this function with the following functions.

- C[Size] (A 53)
- C[Multi-Up Print] (A 56)
- C[2 Up] (A 60)
- C[Book Shadow] (A 51)
- C[Paper Memory Print] (A 64)
- C[Overlay] (A 68)
- C[Quick Master Making] (A 53)

1 Touch [Binding Margin Adj.] in the [Functions] tab screen.

2 Touch the button for the side where you want to extend the margin.

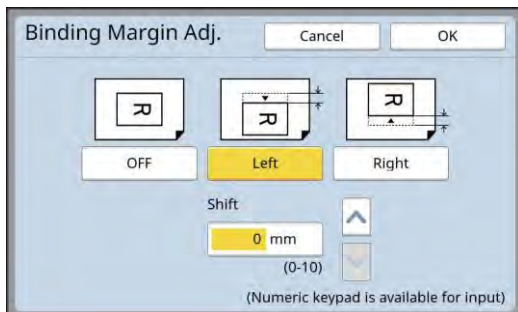

■ [Left]

Extends the margin on the left side when facing in the paper feeding direction.

■ [Right]

Extends the margin on the right side when facing in the paper feeding direction.

3 Specify the length to shift.

You can specify the length to shift using either of the following methods.

- Entering a numeric value using the numeric keys.
- Touching [F] or [G].



B Pressing the [C] key returns the length to [0 mm] ([0.0 inches]).

4 Touch [OK].

Checking the Original Data Image [Preview]

You can check the scan image of the original and the original data image that is retrieved from [Storage] or [USB Job List].

BYou cannot use this function with the following functions.

- C[Ink Saving] (A 52)
 - C[Quick Master Making] (A 53)
- B[Preview] is turned [ON] automatically when the following functions are set:
- C[Multi-Up Print] (A 56)
 - C[2 Up] (A 60)

Description of the screen

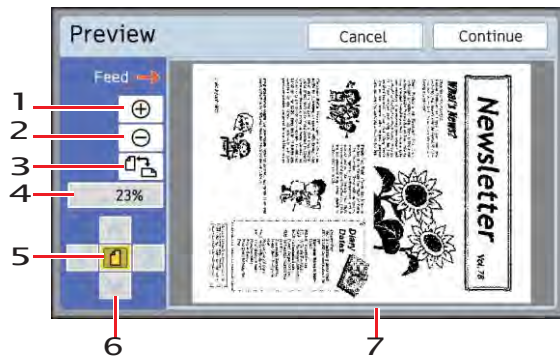

1	Touch this button to enlarge the view by one level.
2	Touch this button to reduce the view by one level.
3	Touch this button to switch between [R (vertical)] and [Q (horizontal)] alternately.
4	Shows the current magnification rate.
5	Touch this button to change the magnification rate so that the whole view of the original data image fits in the display area.
6	Use these buttons to move the display position.
7	Shows the original data image.

B Even when the image is fully displayed in the [Preview] screen, the image parts outside the range for master making are not printed. Check that the margins are sufficient.
(A 16 “Master making area”)

How to display the preview

You can display the [Preview] screen in the following situations.

Situation	Display method
Making a master for a paper original	Touch [Preview] in the [Functions] tab screen of the master making basic screen. After scanning of an original, the [Preview] screen is displayed.
Saving a paper original as data	Touch [Preview] in the [Functions] tab screen of the scan basic screen. After scanning an original, the [Preview] screen is displayed.
Printing original data received from the computer	Touch [Preview] in the [Basic] tab screen of the master making basic screen for the original data. B [Preview] is not available when [Auto Process] is turned on as the operation does not stop before master making.
Printing the saved original data	There are the following two methods. <ul style="list-style-type: none"> • Touch [Preview] in the [Storage Retrieve] or [USB Job List] screen. • Touch [Preview] in the [Basic] tab screen of the master making basic screen for the original data.

Operation procedure in the [Preview] screen

This section describes the operation procedure to make a master from a paper original as an example.

1 Touch [Preview] in the [Functions] tab screen.

2 Set the master making conditions.
(A 46 “Functions for Master Making”)
(A 84 “Useful Functions”)

3 Press the [START] key.
Scanning of the original starts.
After the original has been scanned, the [Preview] screen is displayed.

4 Check the preview.
• Touch [Continue] to start master making.
• Touch [Cancel] to stop master making.

BIf [Close] is displayed, touch [Close].

Checking a Proof Copy of Each Page [ADF Semi-Auto]

[ADF Semi-Auto] is displayed when the optional auto document feeder has been installed.

When you place originals on the auto document feeder and turn on [ADF Semi-Auto], the printing flow will be as shown below.

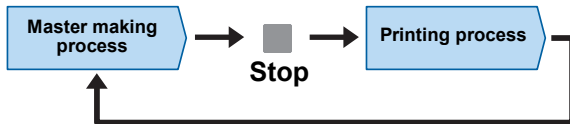

- As the operation stops after master making is complete, you can check a proof copy before a large amount of printing.
- As master making for the next page starts automatically after the printing process, you can efficiently continue the operation.



BFor the printing flow when [ADF Semi-Auto] is off, see the page below. (A 25 “What is [Auto Process]?”)

BYou can change the default setting in [ADF Semi-Auto] (A 112) under [Admin.].

1 Set the originals on the auto document feeder.

(A 31 “Placement of Originals”)

2 Turn off [Auto Process].

When [Auto Process] is on, press the [AUTO PROCESS] key to turn [Auto Process] off.

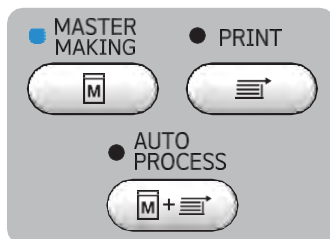

3 Touch [ADF Semi-Auto] in the [Functions] tab screen.

[ADF Semi-Auto] turns on.

Using Paper Memory Original [Paper Memory Print]

Even if this machine cannot be connected to a computer, you can still perform high-resolution printing similar to printing that is performed directly from a computer.

Using the RISO Printer Driver function, you can convert original data created on a computer into a digital pattern, and then print it with a laser printer*. The paper is called a “Paper Memory Original”. You can use the [Paper Memory Print] function of this machine to reproduce and print the source original data from the Paper Memory Original.

* A laser printer of 600 dpi or more is required to create a Paper Memory Original. However, this machine may not be able to scan it properly depending on the model and print quality of the laser printer.

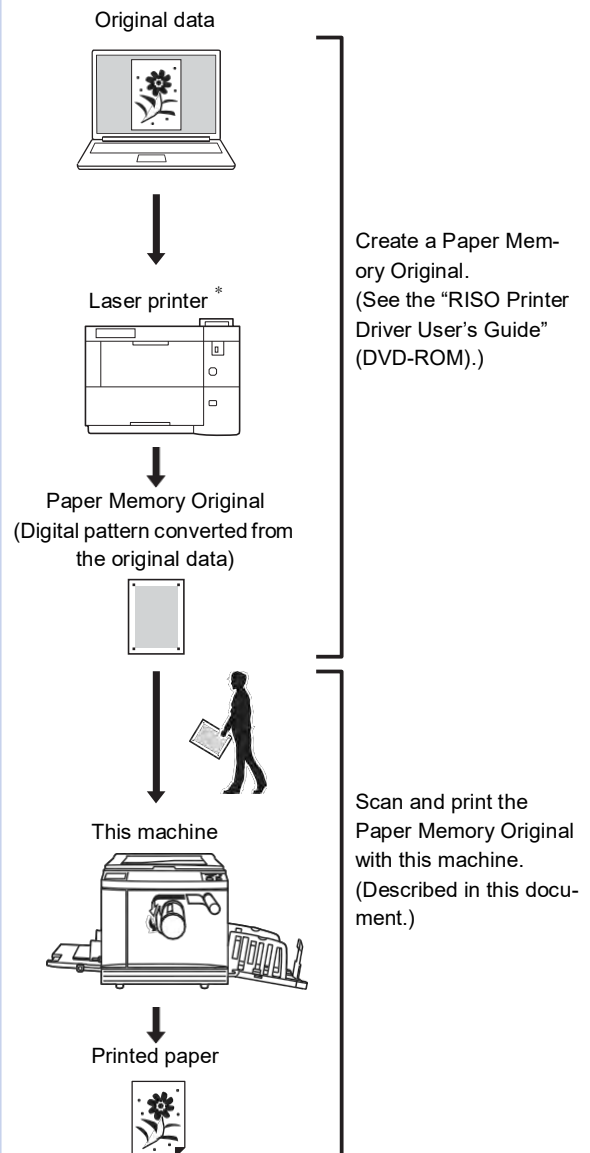

This section describes the procedure to scan and print Paper Memory Originals with this machine.



B For the procedure on creating Paper Memory Originals, see the “RISO Printer Driver User’s Guide” (DVD-ROM).

1 Place the paper.

Check the header section of the Paper Memory Original. Place paper of the size printed on the header section.

2 Place a Paper Memory Original on the glass platen.

Confirm that “P.1” is printed on the header section of the Paper Memory Original. Check that the model printed on the footer section of the paper memory original matches your printer.

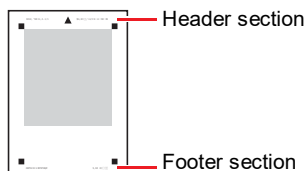

When placing the original, turn it so the printed side is facing down. Then align the center of the original with the [H] mark. Then, close the platen cover.

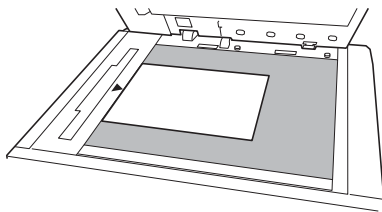

B This machine may not be able to scan the Paper Memory Original properly in the following cases:

- C** The glass platen or platen cover pad is stained.
- C** The Paper Memory Original is stained, wrinkled, or creased.

3 Touch [Paper Memory Print] in the [Functions] tab screen.

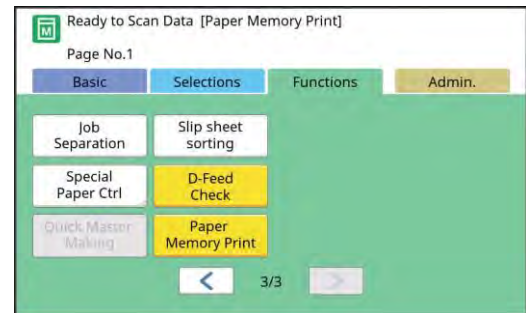

4 Press the [START] key.

The Paper Memory Original is scanned.



B When you have multiple pages of the Paper Memory Original, after the scanning of the original is complete, replace the original with the next page number and press the [START] key.

5 Confirm the original information.

When scanning of the Paper Memory Original is complete, the [Preview] screen (A 63) is displayed. Confirm that the displayed original is the one that you want to print.

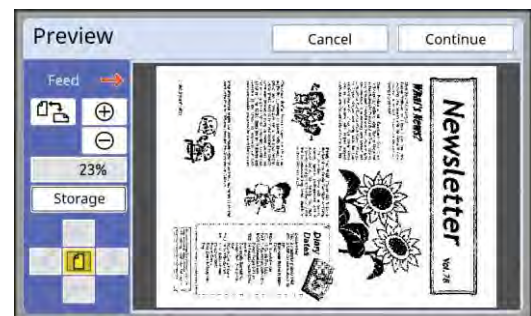

■ [Storage]

When you want to retrieve the original data later and perform printing, follow the below procedure to save the original data.

(If you do not need to save the original data, it is not necessary to carry out this procedure. Go to step 6.)

- 1 Touch [Storage] on the [Preview] screen.
- 2 Select [Storage] or [Print & Storage].
 - [Storage]: Stores original data without printing it.
 - [Print & Storage]: Prints and stores original data.
- 3 Change the following settings as necessary.
 - [File Name] (A 104)
 - [Directory] (A 104)
 - [Owner] (A 104)

- 4 Touch [OK].
The processing you selected in step 2 above is executed.
For details on how to print the saved original data, refer to "Printing the Saved Original Data" (A 40).

6 Touch [Continue].

Master making starts.
The rest of the procedure is the same as the normal printing operation of paper originals. (A 33 "Printing of Paper Originals")

Managing the Saved Original Data [Storage], [USB Job List]

This section describes how to use the screen to retrieve the saved original data.

Operation in the [Storage Selection] screen is explained as an example.

The operation procedure is the same in the [USB Job List] screen.

- For the saving method, see the page below. (A 38 "Saving Paper Original as Data")
- For the printing method, see the page below. (A 40 "Printing the Saved Original Data")

Changing the display style of the list

1 Touch [Storage] in the [Functions] tab screen.

2 Touch [View edit].

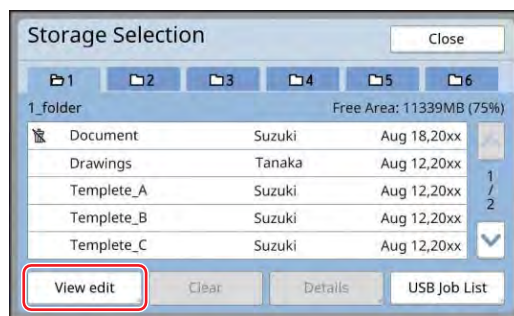

3 Change the settings.

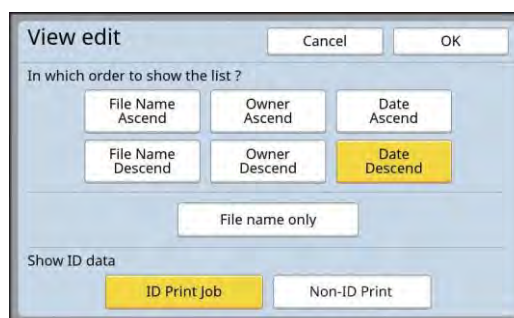

■ Order in which items are listed

You can select in which order the list is sorted.

■ [File name only]

You can change the items to be listed.

OFF: Data name + owner name + saved date
ON: Data name

■ [Show ID data]

[ID Print Job]: Lists only ID data.
[Non-ID Print]: Lists items other than ID data.



B [Show ID data] is displayed when [High/Full Management] or [Mid/ID Print Only] is set in [User Management] (A 122) under [Admin.].

4 Touch [OK].

5 The [Storage Selection] screen is displayed.

Deleting original data

1 Touch [Storage] in the [Functions] tab screen.

2 Touch an original data item that you want to delete.

You can also select multiple original data items.



3 Touch [Clear].



B Original data with the [1] icon displayed at the beginning is set to [Display a message before deleting data] in the printer driver.

When you select such original data and touch [Clear], a confirmation screen is displayed. Touch [OK] in the confirmation screen to remove protection and delete the data.

Details of original data

1 Touch [Storage] in the [Functions] tab screen.

2 Touch an original data item that you want to check.

You can also select multiple original data items.



3 Touch [Details].

The [Storage Retrieve] screen is displayed.

4 Change the settings as necessary.



■ [Rotate]:

Touch this button to print with the original data rotated 180 degrees.

■ [Copy/Move]:

Touch this button to display the [Copy/Move] screen. You can copy or move the original data between [Storage] and [USB Job List].

■ [Output]:

Touch this button to display the [Output] screen. You can change the printing order (ascending / descending) and limit the pages to be printed (odd / even / specified pages).

■ [Preview]:

Touch this button to display the [Preview] screen.

You can check the original data image.

(A 63 "Checking the Original Data Image [Preview]")

- 5 Touch [Retrieve].**
 Touch [Retrieve] to print the original data.
 Touch [Cancel] to immediately close the screen.

Changing to the [USB Job List] screen

You can switch between the [Storage Selection] screen and the [USB Job List] screen alternately.

- 1 Touch [USB Job List] in the [Storage Selection] screen.**



The [USB Job List] screen is displayed.

- B** When you touch [Storage] in the [USB Job List] screen, the [Storage Selection] screen is displayed.

Overlaying Original Data on a Paper Original [Overlay]

You can overlay the original data (saved data) that is saved in [Storage] or [USB Job List] on a paper original.

For example, you can overlay a stamp image of “Sample” on a paper original.



B For the saving method of the overlaying original data in [Storage] or [USB Job List], see the page below.

(A 38 “Saving Paper Original as Data”)

B You cannot use this function with the following functions.

C[Ink Saving] (A 52)

C[Top Margin Adj.] (A 61)

C[Binding Margin Adj.] (A 62)

C[Paper Memory Print] (A 64)

C[Quick Master Making] (A 53)

Final images



- You cannot enlarge or reduce the saved data. The saved data is overlaid using the same size as the data was saved in.
- You cannot adjust the position to overlay the saved data. The saved data is overlaid with the center of the top direction (A 14) for the paper original aligned.

When the saved data is larger than the paper original

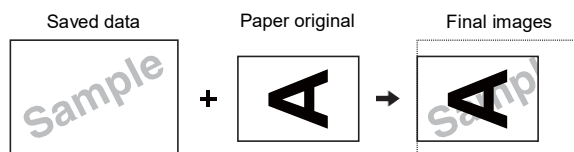

When the saved data is smaller than the paper original

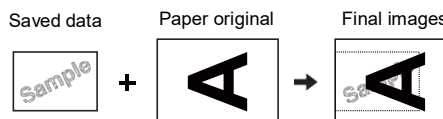

1 Touch [Overlay] in the [Functions] tab screen.

2 Touch an original data item that you want to overlay.

- For the operation in the [Storage Selection] screen, see the page below.
(A 66 “Managing the Saved Original Data [Storage], [USB Job List]”)
- To overlay the saved data that is saved in a USB flash drive, insert the USB flash drive, and then touch [USB Job List].

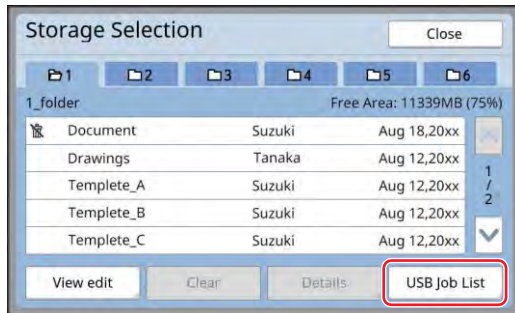

The [Storage Retrieve] screen is displayed. If you use a USB flash drive, the [USB Job List] screen is displayed instead.

3 Touch [Details].

4 Touch [Retrieve].

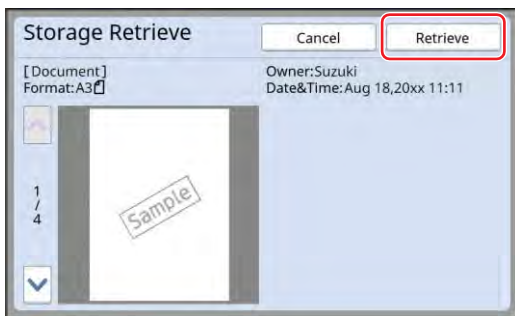

5 Perform the operations required for printing.

The rest of the procedure is the same as the normal printing operation of paper originals.
(A 33 “Printing of Paper Originals”)



B Do not remove the USB flash drive until the printing is completed.



Chapter 4

Functions for Printing

Functions for Printing

For the details and setting procedure of each function, see the pages that are specified as a reference.

■ Functions that are set using hardware keys

[SPEED] (A 72) You can adjust the print speed.
[DENSITY] (A 73) You can adjust the print density.
[PRINT POSITION] (A 74) You can adjust the print position.

■ Functions that are set using the touch panel

[Paper Size] (A 55) You can select a custom paper size.
[Interval] (A 76) You can reduce offsetting of ink on printed paper.
[Renew Page] (A 76) You can make a master again using the image that was used for the latest master making.
[Auto Page Renewal] (A 77) Master making is automatically performed again each time a specified number of sheets has been printed.
[Special Paper Ctrl] (A 77) You can adjust the paper feeding and paper receiving conditions when using special paper.
[Jump Wing Control] (A 81) You can adjust the position of the paper jumping wings to facilitate the receiving of special paper.
[D-Feed Check] (A 81) You can turn on and off the function to check if overlapped sheets of paper are fed.

Adjusting the Print Speed [SPEED]

You can adjust the print speed. It is possible to adjust the print speed not only before but also during the printing process.







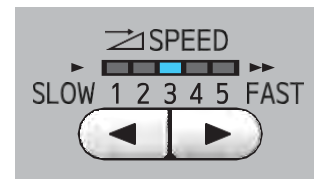

You can change the default setting in [Print Speed] (A 112) under [Admin.].

1 Press the [SPEED] key ([O] or [N]).



- Each press of the [O] key decreases the print speed by one level.
- Each press of the [N] key increases the print speed by one level.

The table below shows the relation between the print speed lamp status and the print speed.

Lamp	Print speed (sheets / minute)
 1 2 3 4 5	Approximately 60
 1 2 3 4 5	Approximately 80
 1 2 3 4 5	Approximately 100
 1 2 3 4 5	Approximately 120
 1 2 3 4 5	Approximately 130
 1 2 3 4 5	Approximately 150 ([High Speed] *)

*The print speed changes to 150 sheets / minute with a single touch of [High Speed] in the print basic screen.

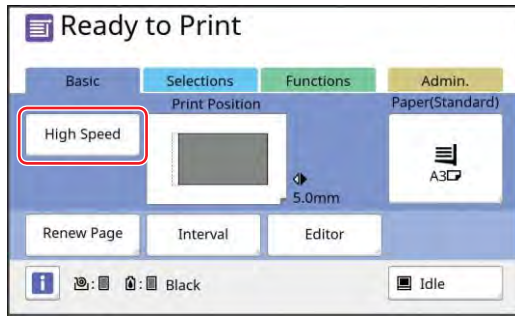

B [High Speed] is available when the temperature in the print drum (cylinder) is 5°C (41°F) or higher. If the print drum (cylinder) is cool, increase the room temperature or print at speed [5] for a while, and wait until the print drum (cylinder) is sufficiently warm.

B Some types of paper may cause a paper jam easily. When using such paper, print at a lower speed.



B You cannot use [High Speed] with the following functions.

C [Slip sheet sorting] (A 89)

Adjusting the Print Density [DENSITY]

You can adjust the print density. It is possible to adjust the print density not only before but also during the printing process.



B You can change the default setting in [Print Density] (A 112) under [Admin.].

B When [Ink Saving] (A 52) is turned on, the print density cannot be changed. (The print density lamp is turned OFF.)

1 Press the [DENSITY] key ([O] or [N]).



- Each press of the [O] key decreases the print density by one level.
- Each press of the [N] key increases the print density by one level.

The print density lamp shows the current print density level.

Adjusting the Print Position [PRINT POSITION]

You can adjust the print position. The adjustment method differs between the horizontal direction and vertical direction.

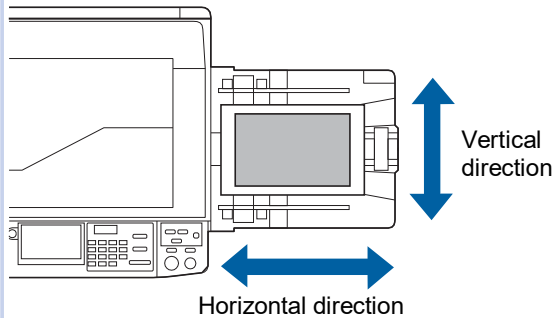

Adjusting the position in the horizontal direction

You can adjust the print position in the horizontal direction using the [PRINT POSITION] keys on the control panel. It is possible to adjust the print position not only before but also during the printing process.

1 Press the [PRINT POSITION] key ([O] or [N]).

Each press of the [O] or [N] key moves the printed image by 0.5 mm (1/64 inches).

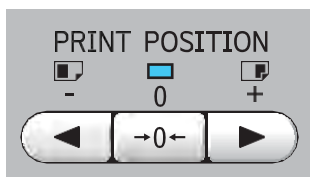

B Press the [P] key to return the printed image to the standard position.

2 Check the shifted length.

The length that the printed image has been shifted in the horizontal direction is displayed on the touch panel screen.

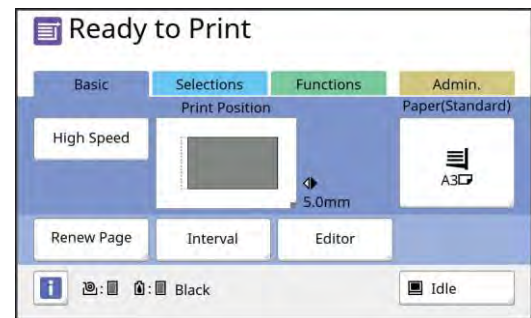

B The shifted length that is displayed on the screen is a reference value. After the adjustment, press the [PROOF] key to check the printed paper.

! If the following operations are performed, the print position in the horizontal direction is returned to the standard position.
C Press the [RESET] key.
C Turn off the power.

Adjusting the position in the vertical direction

You can adjust the print position using the vertical print position adjustment dial on the paper feed tray.

1 Lower the paper feed tray.

Press the feed tray ascent / descent button to lower the paper feed tray until the paper feed roller separates from the paper.

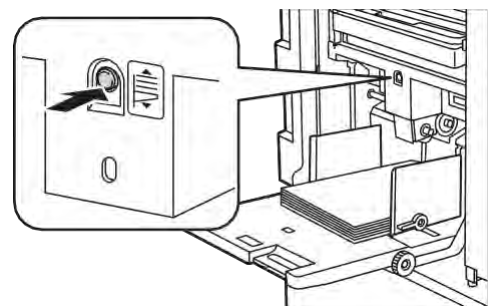

2 Turn the vertical print position adjustment dial.

The print position in the vertical direction is not displayed on the touch panel screen. Adjust the vertical print position while checking the scale for the shifted length.

The [M] symbol on the scale indicates the standard print position.

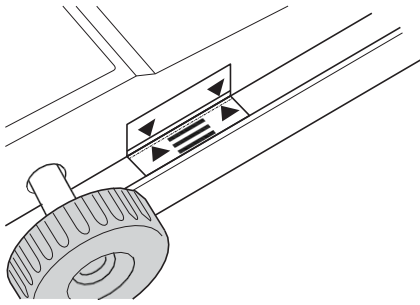

B The scale is only a reference. After the adjustment, press the [PROOF] key to check the printed paper.

■ Moving the printed image upward on the paper

Turn the dial clockwise.

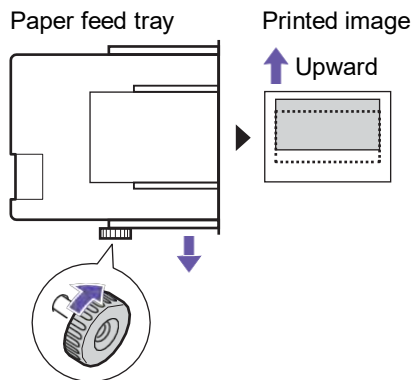

As the paper feed tray moves to the front of this machine, the printed image is shifted upward relative on the paper.

■ Moving the printed image downward on the paper

Turn the dial counterclockwise.

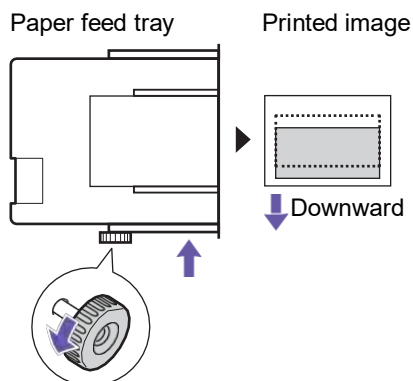

As the paper feed tray moves to the back of this machine, the printed image is shifted downward relative on the paper.

3 Adjusting the position of the receiving-tray paper guides

Adjust the position of the receiving-tray paper guides according to the shifted length of the paper feed tray. If the positions of the paper feed tray and the receiving-tray paper guides are not aligned, a paper jam may occur. (A 29 “Setting up the paper receiving tray”)

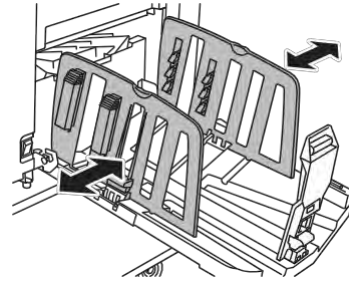

B After the printing process is complete, return the positions of the paper feed tray and the receiving-tray paper guides to their standard positions. To return the paper feed tray to the standard position, turn the dial until the edge of the paper feed tray aligns with the [M] symbol on the scale.

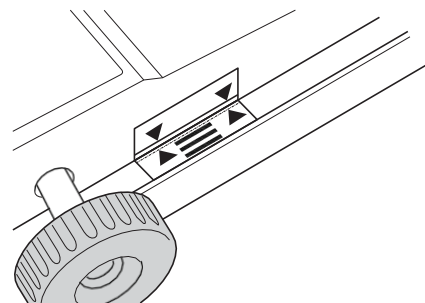

Reducing Offset of Ink [Interval]

Printed paper is output at a high speed on this machine. Depending on the paper, ink on a printed sheet may not be dried sufficiently. This ink may smear on the back surface of the next printed sheet. In this case, set a longer interval until the next printed sheet is output. This helps the ink dry and prevents an offset. You can adjust the interval until the next printed sheet is output using the idle rotations of the print drum (cylinder).



BYou cannot use this function with the following function.
C[Slip sheet sorting] (A 89)

- 1 Touch [Interval] in the [Functions] tab screen.
- 2 Touch [ON].

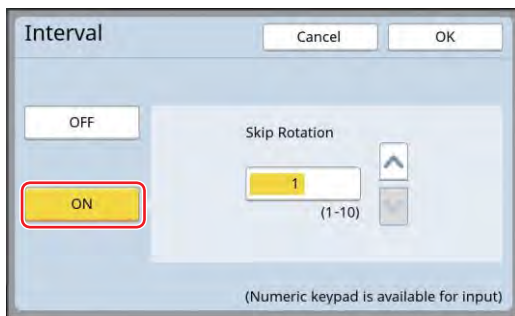

- 3 Specify the number for [Skip Rotation].

You can specify the number for [Skip Rotation] using either of the following methods.

- Entering a numeric value using the numeric keys.
- Touching [F] or [G].



BPress the [C] key to return the number to [1].

- 4 Touch [OK].

Making a Master Again [Renew Page]

This machine temporarily stores an image that was used for the latest master making.

You can perform master making with the image by using [Renew Page]. This function is useful as you do not need to place the original and perform settings again.

The master may be deteriorated during the printing process of a large amount of sheets.

In this case, as the master is replaced with a new one by selecting [Renew Page] while the current setting remains as it is, the print quality can be maintained at a constant level.



BNote that [Renew Page] is not available under the following conditions.

- C**Master making has never been performed after turning on the power switch of this machine.
- C**After the [RESET] key has been pressed.
- C**When the time that is set in [Auto Clear] (A 115) elapses.
- C**After [Confidential] has been performed.
- C**When an error occurred before completing master making.
- C**After [Idling Action] has been performed.*

* [Renew Page] can be performed if any of [Preview], [Overlay], or [Book Shadow] has been set.

- 1 Touch [Renew Page] in the [Functions] tab screen.
- 2 Touch [Rotate] as necessary.

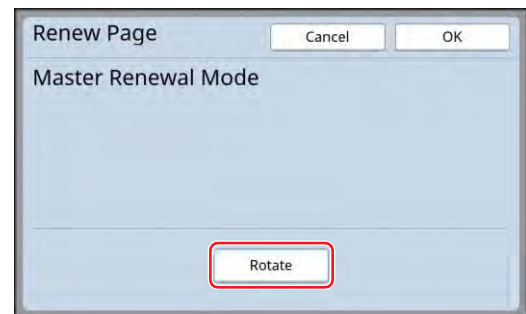

BThe [Rotate] setting that is specified in this screen is also applied to [Auto Page Renewal].

- 3 Touch [OK].

Making a Master Again Automatically [Auto Page Renewal]

When printing a large amount of sheets, such as thousands of sheets, the master may be deteriorated during the printing process. If [Auto Page Renewal] is turned on, the master is made again automatically each time a specified number of sheets has been printed. Therefore, the printing process can be continued. As the master is replaced with a new one before it is deteriorated, the print quality can be maintained at a constant level.

 It is necessary to select [ON] for [Auto Page Renewal] (A 116) under [Admin].

1 Touch [Auto Page Renewal] in the [Functions] tab screen.

 [Auto Page Renewal] turns off in the following cases.

C When [Program] is turned on.

C When the [RESET] key has been pressed.

C When the master making basic screen for the next original data is displayed.

B The [Rotate] setting that is specified in the [Renew Page] screen (A 76) is also applied to [Auto Page Renewal].

Adjusting Paper Feeding and Receiving Conditions [Special Paper Ctrl]

You can adjust the paper feeding and paper receiving conditions when using special paper or when unevenness and blurring occur in printed images.



B For appropriate adjustment values, consult your dealer or authorized service representative.

Paper feeding adjustment for special paper

You can adjust the paper feeding conditions depending on the characteristics of the paper.

1 Touch [Special Paper Ctrl] in the [Functions] tab screen.

2 Touch [Paper Feed Adj.].



3 Touch [Manual].

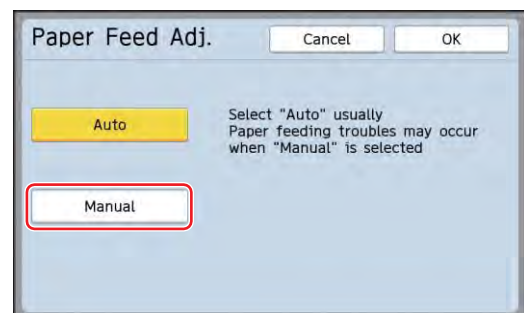

4 Set each item as necessary.

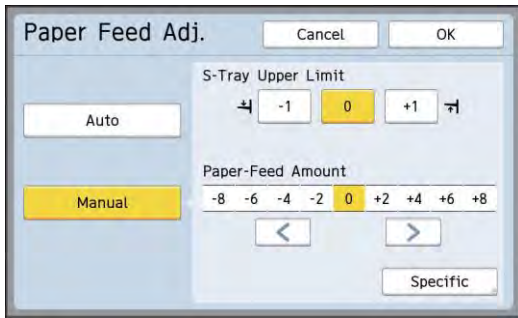

Touch [Specific] to specify [Clutch ON Timing] and [Clutch OFF Timing].

5 Touch [OK].

The [Special Paper Ctrl] screen is displayed.



It is useful if you register the adjustment values that you have set. (A 78 “Registering the adjustment values”)

6 Touch [Close].

Paper receiving adjustment for special paper

You can adjust the paper receiving conditions depending on the characteristics of the printed image and the paper.



You can change the default setting in [Paper Ejection Adj] (A 113) under [Admin.].

1 Touch [Special Paper Ctrl] in the [Functions] tab screen.

2 Touch [Paper Eject Adj].



3 Set each item as necessary.



4 Touch [OK].

The [Special Paper Ctrl] screen is displayed.



It is useful if you register the adjustment values that you have set. (A 78 “Registering the adjustment values”)

5 Touch [Close].

Registering the adjustment values

It is useful if you register the adjustment values that you have set in [Paper Feed Adj.] and [Paper Eject Adj] as the values can be used repeatedly.

1 Change the settings for [Paper Feed Adj.] and [Paper Eject Adj].

For the procedure to perform settings, see A 77.

2 Touch [Entry/Call].

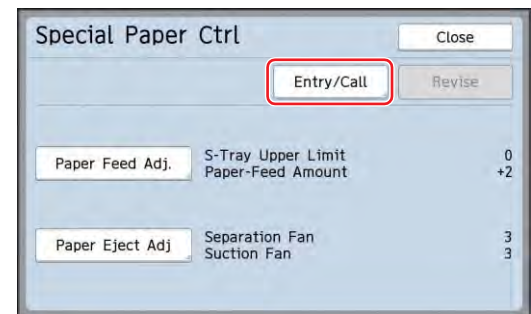

3 Touch a button for which nothing has been registered.

The button for which nothing has been registered is outlined with a solid line.
(You cannot touch a grayed button as the settings have already been registered.)



4 Touch [OK] in the confirmation screen.

The adjustment values that you have set are registered, and the [Parameter List] screen is displayed.



BYou can change the name of the registered adjustment values.
(A 80 “Changing the name of adjustment values”)

5 Touch [Close].

The [Special Paper Ctrl] screen is displayed.

Retrieving the adjustment values

1 Touch [Special Paper Ctrl] in the [Functions] tab screen.

2 Touch [Entry/Call].

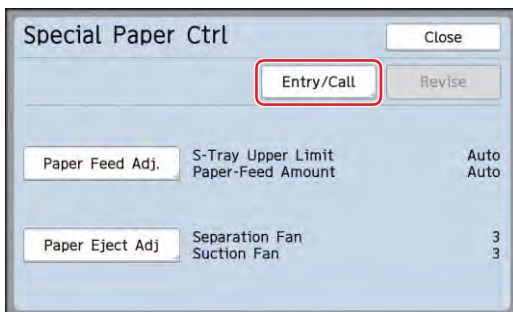

3 Touch [Retrieve].



4 Touch the button for the settings that you want to retrieve.

The [Special Paper Ctrl] screen is displayed. Check that the name of the retrieved adjustment values is displayed.



BYou can change and overwrite the settings of the adjustment values that you retrieved.
(A 79 “Changing the adjustment value settings”)

Changing the adjustment value settings

1 Retrieve adjustment values.

Perform steps 1 to 4 in “Retrieving the adjustment values”.

2 Change the settings for [Paper Feed Adj.] and [Paper Eject Adj.].

For the procedure to perform settings, see A 77.

3 Touch [Revise].

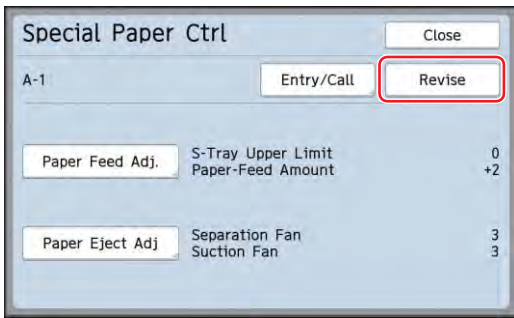

4 Touch [OK] in the confirmation screen.

The changed adjustment values are overwritten, and the [Special Paper Ctrl] screen is displayed.

Changing the name of adjustment values

1 Touch [Special Paper Ctrl] in the [Functions] tab screen.

2 Touch [Entry/Call].

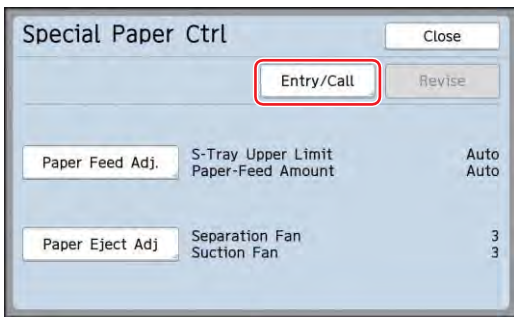

3 Touch [Rename].



4 Touch the button whose name you want to change.

5 Change the name.
(A 24 "[Rename] screen")

6 After entering a new name, touch [OK].

The [Parameter List] screen is displayed.

7 Touch [Close].

The [Special Paper Ctrl] screen is displayed.

Erasing the adjustment values

1 Touch [Special Paper Ctrl] in the [Functions] tab screen.

2 Touch [Entry/Call].

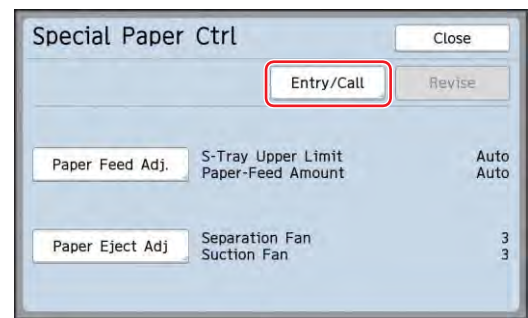

3 Touch [Clear].

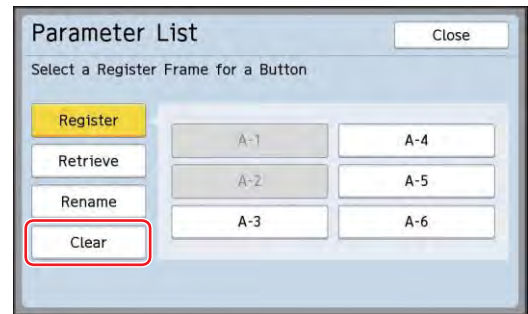

4 Touch the button that you want to erase.

5 Touch [OK] in the confirmation screen.

The [Parameter List] screen is displayed.

6 Touch [Close].

The [Special Paper Ctrl] screen is displayed.

Adjusting the Position of Paper Jumping Wings [Jump Wing Control]

The paper jumping wings are used to eject the printed paper to the paper receiving tray. Normally, the position of the paper jumping wings is adjusted automatically according to the paper size and selection of the position of the paper-feed setting lever (A 28).

When you use paper for which the position cannot be adjusted automatically, turn on [Jump Wing Control]. The paper jumping wings are moved to a special position.

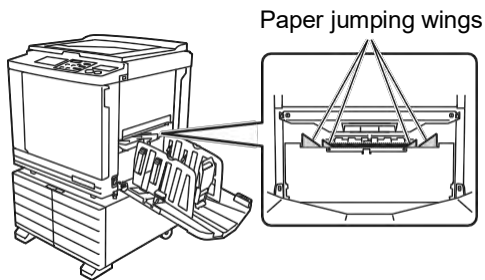

If [Jump Wing Control] is not displayed, special settings are required. For more information, consult your dealer or authorized service representative.



You can change the default setting in [Jump Wing Control] (A 112) under [Admin.].

- 1 Touch [Jump Wing Control] in the [Functions] tab screen.

Monitoring the Feeding State [D-Feed Check]

This machine is equipped with the [D-Feed Check] function, which automatically stops printing when the feeding of overlapped sheets of paper (double feeding) is detected.

[D-Feed Check] is on as a factory default setting. However, since this function is set for normal paper types, the function may detect some paper statuses as an error even when double feeding does not occur.

To avoid such faulty detection, turn OFF [D-Feed Check] in the following cases:

- A [D-Feed Check] error is repeatedly displayed when no double feeding occurs.
- Paper with a dark ground color is used (such as black, red, or deep blue).
- The back side of the paper is already printed.



You can change the default setting in [Double Feed Check] (A 112) under [Admin.].

- 1 Touch [D-Feed Check] in the [Functions] tab screen.



Chapter 5

Useful Functions

Useful Functions

For the details and setting procedure of each function, see the pages that are specified as a reference.
[Program] (A 84) You can separate and sort the printed paper by a specified number of sheets.
[Slip sheet sorting] (A 89) You can use the paper placed on the paper feed tray as slip sheets for sorting printed papers.
[Job Separation] (A 89) You can sort the printed paper. (The optional Job Separator is required.)
[Job Memory] (A 90) You can register a set of required settings.
[Reservation] (A 92) You can prevent unintended printing of data that is received from the computer.
[Idling Action] (A 92) When the print drum (cylinder) has not been used for a long time, you can reduce blurring of ink at the beginning of printing.
[Confidential] (A 93) You can discard the master that has already been used.
[My Direct Access] (A 94) You can select functions to be registered to the Direct Access Area for each user.
[Meter Display] (A 95) You can check the accumulated results for the count of master making processes and the number of copies that have been printed.
[ID Counter Report] (A 96) You can output the total results for the count of master making processes and the number of printed copies.
[Service Info. Mail] (A 100) You can send the operation history of this machine to e-mail addresses that have been specified in advance.
[Editor] This function scans paper originals, then edits the scanned originals and separates the colors. For more information, see the user's guide for the RISO Editor.

Printing the Sorted Originals [Program]

You can separate the number of copies to be printed for each set or each original. As the printing process stops for a few seconds after printing the specified number of copies (for each set or each original), you can sort the printed paper. This function is useful for when the required number of copies to distribute varies for each department or class.



You cannot use this function with [Auto Page Renewal] (A 77).

This function is useful when it is used with [Slip sheet sorting] (A 89) because printed paper is sorted according to each specified separation with a slip sheet.

This function is useful when it is used with [Job Separation] (A 89), because printed paper is sorted according to each specified separation with a tape. The optional Job Separator is required to use [Job Separation].

When the Job Separator is not installed, we recommend that you remove the printed paper from the paper receiving tray or insert an interleaf manually, during the pause of printing for each separation.

Types of [Program]

[Single Page Mode]:

You can set the number of copies to be printed from a single original for each "set".

The "sets" can be organized into a "group".

It is possible to set up to 9999 copies × 99 sets × 150 groups.

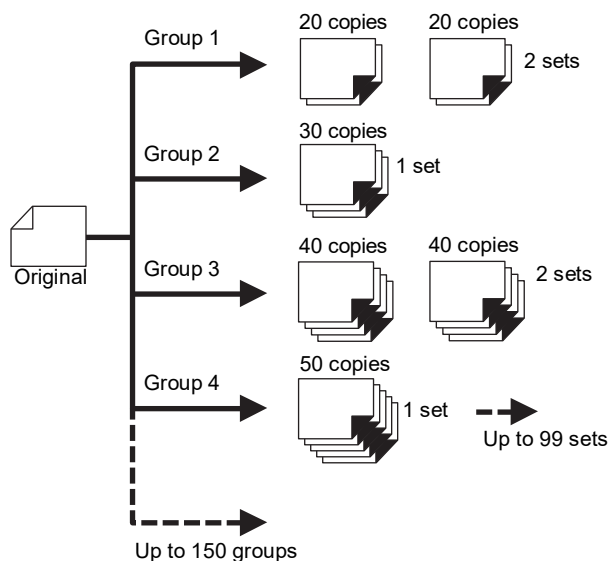

[Multi-Page Mode]:

You can set different numbers of copies for multiple originals.

It is possible to set up to 9999 copies × 20 originals.

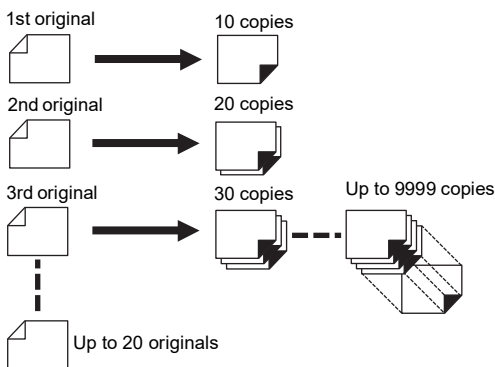
**■ How to use [Program]**

There are the following two methods.

- For printing without registering program settings
(A 85 “Setting [Single Page Mode]”)
(A 86 “Setting [Multi-Page Mode]”)
- For printing by retrieving a registered [Program] setting
(A 87 “Retrieving [Program]”)

Setting [Single Page Mode]**1 Touch [Program] in the [Functions] tab screen.**

The [Program Type] screen is displayed.

-  **B** You can also display the [Program Type] screen by pressing the [P] key.

2 Touch [Single].**3 Enter a value in [Cps.] using the numeric keys.**

You can enter a value into the active entry field.

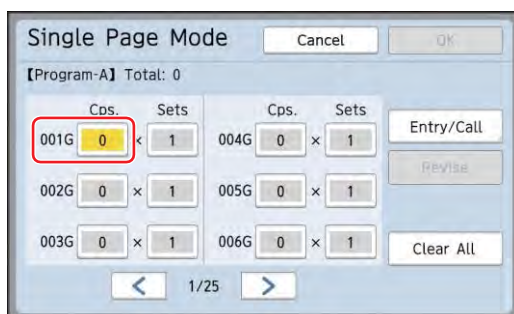
**4 Change the target for entry to [Sets].**

- You can change the target for entry by pressing the [×] key or the [↵] key.
- It is also possible to select the entry field by directly touching the target.

5 Enter a value in [Sets] using the numeric keys.**6 Change the target for entry to the next group.**

- Press the [+] key or the [↵] key.
 - It is also possible to select the entry field by directly touching the target.
- Repeat steps 3 to 6 as necessary.

-  **B** To clear all entered values, touch [Clear All].
- B** The total of the entered number of copies is displayed at the top of the screen.

-  **B** If you want to register the programs that are set in this screen, touch [Entry/Call] before [OK].
- Then, go to step 3 in “Registering [Program]” (A 86).

7 Touch [OK].

The basic screen is displayed. When you press the [START] key, printing is performed according to the program that you set.

-  **B** Printing is performed in the reverse order of registration from the last group. (Example: [003G] → [002G] → [001G])
- In this case, [001G] is output on the top of the printed paper in the paper receiving tray.

Setting [Multi-Page Mode]

1 Touch [Program] in the [Functions] tab screen.

The [Program Type] screen is displayed.



B You can also display the [Program Type] screen by pressing the [P] key.

2 Touch [Multiple].

3 Enter a value in [Cps.] using the numeric keys.

You can enter a value into the active entry field.

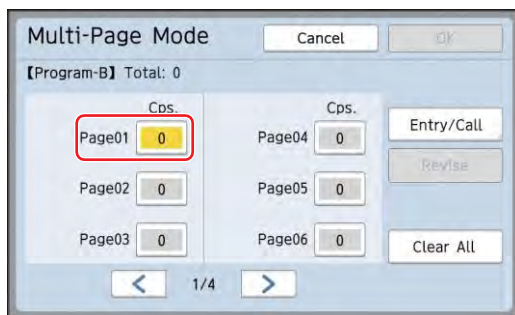

4 Change the target for entry to the next field.

- Press the [+] key or the [↓] key.
 - It is also possible to select the entry field by directly touching the target.
- Repeat steps 3 to 4 as necessary.



B To clear all entered values, touch [Clear All].

B The total of the entered number of copies is displayed at the top of the screen.



B If you want to register the programs that are set in this screen, touch [Entry/Call] before [OK]. Then, go to step 3 in “Registering [Program]” (A 86).

5 Touch [OK].

The basic screen is displayed.

When you press the [START] key, printing can be performed according to the program that you set.



B Printing is performed in the reverse order of registration from the last original. (Example: [Page 03] -> [Page 02] -> [Page 01]) In this case, [Page 01] is output on the top of the printed paper in the paper receiving tray.

Canceling [Program]

1 Touch [Program] in the [Functions] tab screen.

The [Program Type] screen is displayed.



B You can also display the [Program Type] screen by pressing the [P] key.

2 Touch [Cancel Job].

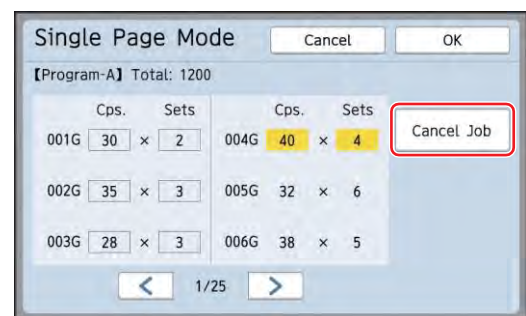

3 Touch [OK].

Registering [Program]

It is useful if you register a program that is used frequently.

You can register a total of 12 [Single Page Mode] and [Multi-Page Mode] programs.

1 Set a program.

Perform either of the following settings.

- Steps 1 to 6 in “Setting [Single Page Mode]” (A 85)
- Steps 1 to 4 in “Setting [Multi-Page Mode]” (A 86)

2 Touch [Entry/Call].

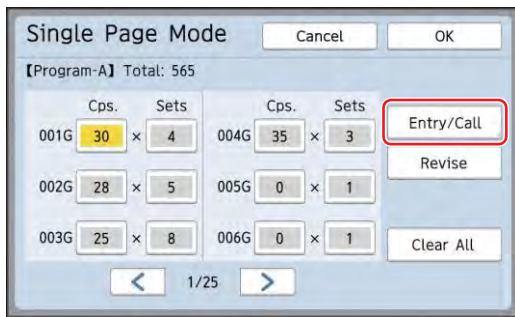

3 Touch a button for which nothing has been registered.

The button for which nothing has been registered is outlined with a solid line. (You cannot touch a grayed button as the settings have already been registered.)



A confirmation screen is displayed.

4 Touch [OK] in the confirmation screen.

The program that has been set is registered and the [Program List] screen is displayed.



B You can change the name of the registered program.
(A 88 “Changing the name of [Program]”)

5 Touch [Close].

The [Program] setting screen is displayed.

- When you touch [OK], printing can be performed according to the registered program settings.
- When you touch [Cancel], the basic screen is displayed with [Program] remaining off.

Retrieving [Program]

1 Touch [Program] in the [Functions] tab screen.

The [Program Type] screen is displayed.



B You can also display the [Program Type] screen by pressing the [P] key.

2 Touch [Program List].

3 Touch the button for the settings that you want to retrieve.



B The icon on the button indicates the type of program.

: [Single Page Mode]

: [Multi-Page Mode]

4 Touch [OK] in the confirmation screen.

The basic screen is displayed.

When you press the [START] key, printing is performed according to the program that you set.

Changing the settings of [Program]

1 Retrieve a program.

Perform steps 1 to 3 in “Retrieving [Program]”.

2 Change the settings of the program.

Change the number of copies and the number of sets.

3 Touch [Revise].

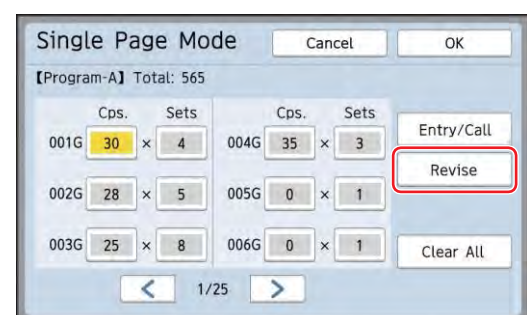

4 Touch [OK] in the confirmation screen.

The [Program] setting screen is displayed.

- When you touch [OK], printing can be performed according to the changed program settings.
- When you touch [Cancel], the basic screen is displayed with [Program] remaining off.

Changing the name of [Program]

1 Touch [Program] in the [Functions] tab screen.

The [Program Type] screen is displayed.

-  **B** You can also display the [Program Type] screen by pressing the [P] key.

2 Touch [Program List].

3 Touch [Rename].

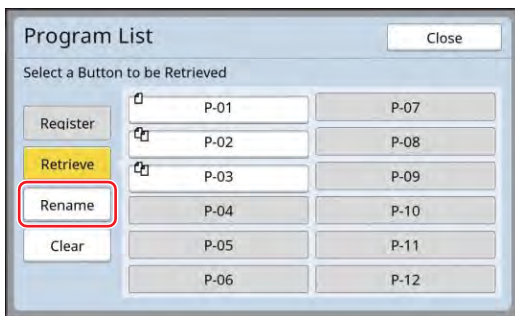

4 Touch the button whose name you want to change.

5 Change the name. (A 24 "[Rename] screen")

6 After entering a new name, touch [OK].

The [Program List] setting screen is displayed.

7 Touch [Close].

The [Program Type] setting screen is displayed.

8 Touch [Close]. The basic screen is displayed.

Erasing [Program]

1 Touch [Program] in the [Functions] tab screen.

The [Program Type] screen is displayed.

-  **B** You can also display the [Program Type] screen by pressing the [P] key.

2 Touch [Program List].

3 Touch [Clear].

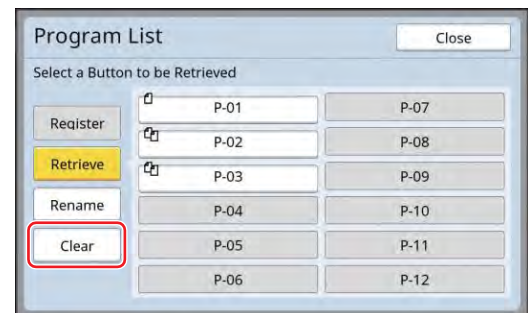

4 Touch the button that you want to erase.

5 Touch [OK] in the confirmation screen.

The [Program List] setting screen is displayed.

6 Touch [Close].

The [Program Type] setting screen is displayed.

7 Touch [Close].

The basic screen is displayed.

Inserting Slip Sheet [Slip sheet sorting]

You can use the paper placed on the paper feed tray as slip sheets for sorting printed papers.

- When you print with [Auto Process] turned on after placing originals on the auto document feeder, turn on [Slip sheet sorting] to insert a slip sheet (blank sheet) each time the original changes.
- When you use [Program] (A 84) together with [Slip sheet sorting], a slip sheet (blank sheet) is inserted between each separation of the printing.



B[Slip sheet sorting] can be used when the following papers are placed on the paper feed tray:
(Standard sizes)
SF9350EII, SF9250EII: A3p, B4p, A4p, or Foolscapp
SF9450EII: Ledgerp, Legalp or Letterp
(Custom sizes)
210 mm × 280 mm to 310 mm × 432 mm
(8 1/4 inches × 11 1/32 inches to 12 7/32 inches × 17 inches)

BSlip sheets and printed papers may be smudged with ink.



BThis function works only when [Program] (A 84) or [Auto Process] (A 25) is [ON].
BYou cannot use this function with the following functions.
C[Interval] (A 76).
C[Job Separation] (A 89).
C[High Speed] under [SPEED] (A 72).
BYou can change the default setting in [Slip sheet sort set.] (A 112) under [Admin.].

- 1** Touch [Slip sheet sorting] in the [Functions] tab screen.

Using the Job Separator [Job Separation]

You can use the [Job Separation] function after installing the optional Job Separator.

- When you print with [Auto Process] turned on after placing originals on the auto document feeder, turn on [Job Separation] to insert a piece of tape each time the original changes.
- When you also use [Program] (A 84) together, a piece of tape is inserted in each separation of the printing.

For more information, see the user's guide for the Job Separator.



BThis function works only when [Program] (A 84) or [Auto Process] (A 25) is [ON].

BYou cannot use this function with the following function.

C [Slip sheet sorting] (A 89)
BYou can change the default setting in [Job Separation] (A 112) under [Admin.].

- 1** Touch [Job Separation] in the [Functions] tab screen.

Using the Registered Settings [Job Memory]

You can register a set of required settings. This function is useful as the same settings can be retrieved for use.

Registering [Job Memory]

1 Set the required functions.

- (A 46 “Functions for Master Making”)
- (A 72 “Functions for Printing”)
- (A 84 “Useful Functions”)

2 Touch [Job Memory] in the [Functions] tab screen.

The [Job Memory] screen is displayed.



You can also display the [Job Memory] screen by pressing the [U] key.

3 Touch a button for which nothing has been registered.



You cannot touch a grayed button as the settings have already been registered.

4 Check the settings.

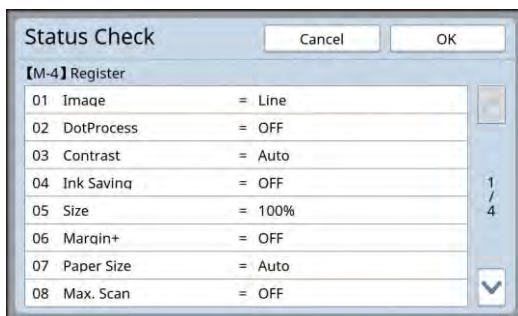

Touch [G] to check all items to the end of the list.



When you want to change the setting of any function, touch [Cancel] and then [Close] to go back to the basic screen. Then revise the setting of the function.

5 Touch [OK].

The [Job Memory] screen is displayed.

6 Touch [Close].

The basic screen is displayed.

Retrieving [Job Memory]

1 Touch [Job Memory] in the [Functions] tab screen.

The [Job Memory] screen is displayed.



You can also display the [Job Memory] screen by pressing the [U] key.

2 Touch [Retrieve].

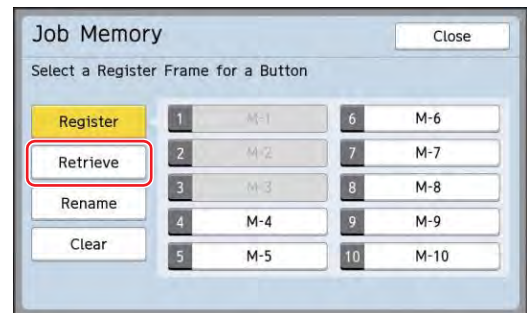

3 Touch the button for the settings that you want to retrieve.

The [Status Check] screen is displayed.



You can also display the [Status Check] screen by pressing the numeric keys corresponding to the relevant memory number.

C Numbers [1] to [9]: Press the corresponding key from “1” to “9”.

C Number [10]: Press the “0” key.

4 Check the settings.

5 Touch [OK].

The settings are applied and then the basic screen is displayed.

Changing the name of [Job Memory]

- 1 Touch [Job Memory] in the [Functions] tab screen.

The [Job Memory] screen is displayed.

 You can also display the [Job Memory] screen by pressing the [U] key.

- 2 Touch [Rename].

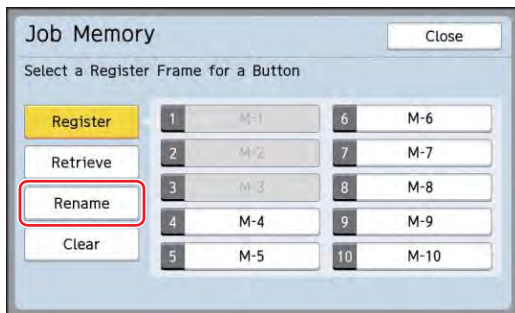

- 3 Touch the button whose name you want to change.

- 4 Change the name.

(A 24 "[Rename]screen")

- 5 After entering a new name, touch [OK].

The [Job Memory] screen is displayed.

- 6 Touch [Close].
The basic screen is displayed.

Erasing [Job Memory]

- 1 Touch [Job Memory] in the [Functions] tab screen.

The [Job Memory] screen is displayed.

 You can also display the [Job Memory] screen by pressing the [U] key.

- 2 Touch [Clear].



- 3 Touch the button that you want to erase.

The [Status Check] screen is displayed.

- 4 Check the settings.
Check whether the setting can be erased.

- 5 Touch [OK].
The [Job Memory] screen is displayed.

- 6 Touch [Close].
The basic screen is displayed.

Extending the Reserve Period [Reservation]

This function is useful when this machine is connected to a computer.

During the printing operation on this machine, another person may send a print instruction for the original data from a computer.

Even if this machine has been left untouched after the operation stops, master making of the received original data does not start until a certain amount of time has elapsed. This certain amount of time is referred to as a "Reserve Period".

When the reserve period has elapsed, another master making of the original data starts. As a result, the master that is being used is discarded. The factory default of the reserve period is 15 seconds. You can extend this period in the [Admin.] screen up to 60 seconds.

When you want to continue the printing operation with the master that you are currently using, turn on [Reservation]. You can extend the reserve period up to 30 minutes.



You can change the reserve period in [Reserve Period] (A 115) under [Admin.].

You can change the extended time when [Reservation] is turned on in [Ex. Reserve Period] (A 115) under [Admin.].

■ The reserve period does not start counting during the following operations.

- While an operation (master making, printing process, etc.) is in progress on this machine.
- While any key or button of the control panel is being operated.
- While a setting screen is displayed.
- While an error or a warning screen is displayed.
- Up to 3 minutes after you switch to master making mode.

■ The following functions are not performed during the extended period of the reserve period.

- [Auto Sleep] (A 115), [Auto Power-OFF] (A 115): These functions are performed based on the time measured from the end of the period that is set in [Reservation].
- [Power-OFF Schedule] (A 115): This function is not performed until the set time on the next day.

1 Touch [Reservation] in the [Functions] tab screen.



If you want to print original data during the [Reserve Period], touch [Pause] (A 35) in the [Basic] tab screen.

Preventing Blurring of Ink [Idling Action]

When this machine has not been used for a long time or after the print drum (cylinder) has been replaced, several sheets of printing may be faded at the beginning of printing. When you turn on [Idling Action], the operation to ensure the ink usability and stability is performed during master making. As this function enables clear printing from the beginning, you can save paper.



[Idling Action] is a function that is performed during master making. If you perform the printing process only, [Idling Action] is not performed.

When [Idling Action] is performed, the time required for master making becomes longer.





You can set [Idling Action] to be performed automatically during the next master making if the print drum (cylinder) has not been used for a long time. You can change the setting in [Auto Idling] (A 116) under [Admin.].

1 Touch [Idling Action] in the [Functions] tab screen of the master making basic screen.



When [Idling Action] is turned on, the icon that is displayed in the message area of the master making basic screen is changed.

[Idling Action]	Icon
OFF	 (White icon on green base)
ON	 (Green icon on yellow-green base)

When you place an original and press the [START] key, [Idling Action] is performed during master making.

Preventing Copying of Confidential Documents [Confidential]

After printing, the master that has been made is still loaded on the print drum (cylinder) in the print ready status.

When [Confidential] is turned on, the master that has been made is discarded. Therefore, you can prevent improper printing of confidential documents.

As a blank master is loaded on the print drum (cylinder), the master also plays the role of a cover to prevent ink in the print drum (cylinder) from drying out when printing is not performed for a long time.



BYou can make a setting for the [Confidential] process, which is recommended after printing. (A 128 "Managing the Used Master [Protect]")

1 Touch [Confidential] in the [Functions] tab screen.

2 Touch [OK].

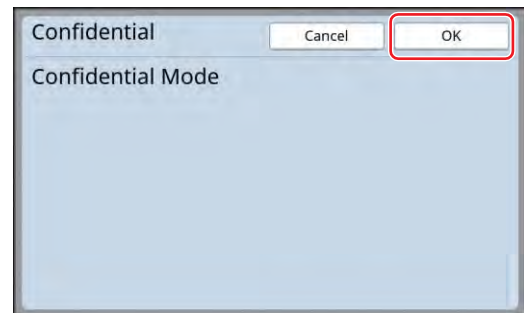

The master on the print drum (cylinder) is discarded and a blank master is loaded.



BThe [Confidential] process erases the image that is temporarily stored in this machine. As a result, [Renew Page] (A 76) cannot be performed.

Registering Frequently Used Functions for Each User [My Direct Access]

If you perform the authentication operation to use this machine, you can change the functions to be registered in the Direct Access Area in the [Basic] tab screen as you want.

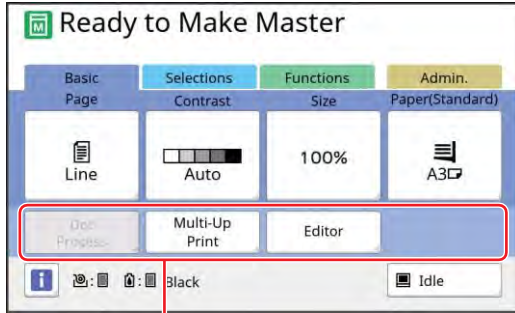

Direct Access Area

You can register a function to the Direct Access Area in the following modes.

- Master making mode
- Printing process mode
- Scan mode

! B[High/Full Management] must have been set for [Management Level] in [User Management] (A 122).

✍ BBy using [DirectAccess Entry] (A 117) under [Admin.], an administrator can change the Direct Access Area for all users at the same time.

1 Touch [My Direct Access] in the [Functions] tab screen.

2 Touch the mode tab in which you want to register a function.

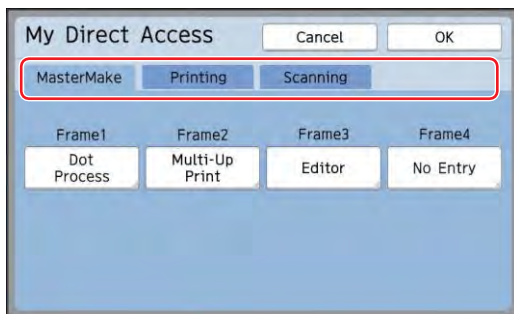

3 Touch the function button that you want to register.

You can also touch the button for which a function has already been registered to change to another function.

4 Touch the function name to be registered.



- Touch [For []] to change the display.
- If you do not want to register any function, touch [No Entry].
- You cannot touch a function name that has already been registered.

5 Touch [OK].
The [My Direct Access] screen is displayed. When you want to register another function button, repeat steps 3 to 5.

6 Touch [OK].

Displaying the Accumulated Counts [Meter Display]

You can check the accumulated results for the count of master making processes and the number of printed sheets.

- 1 Touch **[Meter Display]** in the **[Functions]** tab screen.
- 2 Check the contents in the display.

Meter Display		Close
A4/Letter and Under	25,000	
Above A4/Letter	25,000	
Total	50,000	
A3/Ledger Master Count	25,000	
A4W/LetterW Master Count	25,000	
Master Count Total	50,000	
Print Drum Meter	9,999	
Job Count	0	◀ C

■ [A4/Letter and Under], [Above A4/Letter]

Shows the accumulated number of copies that have been printed on this machine for each size.

The value does not include proof copies that were output during master making.

■ [Total] (total counter)

Shows the accumulated number of copies that have been printed on this machine.

The value does not include proof copies that were output during master making.

■ [A3/Ledger Master Count], [A4W/LetterW Master Count]

Shows the accumulated count of master making processes that have been performed on this machine for each master size.

The value includes the count of [Idling Action] (A 92) and [Confidential] (A 93) that have been performed.

■ [Master Count Total]

Shows the accumulated count of master making processes that have been performed on this machine.

The value includes the count of [Idling Action] and [Confidential] that have been performed.

■ [Print Drum Meter]

Shows the accumulated number of copies that have been printed using the current print drum (cylinder).

The value includes the count of proof copies that were output during master making.

To check the accumulated number of copies that have been printed using another print drum (cylinder), change the print drum (cylinder) and then display the [Meter Display] screen again.

■ [Job Count]

Counts and shows the number of copies that have been printed.

The value does not include proof copies that were output during master making.

Touching [↵] resets the count to [0].

For example, this counter is useful when you want to check the number of copies that are printed per day. In this case, reset the counter to [0] at the start of operation for the day and then check the counter at the end of the operation.

- 3 Touch **[Close]**.

Calculating the Total Number of Copies [ID Counter Report]

You can print the total counts of master making processes and the total number of printed sheets of all users. You can also save these data to a file.



To manage and calculate the total number of copies, [High/Full Management] must have been set for [Management Level] in [User Management] (A 122).

■ [USB Flash Drive]

Touch this button to save the CSV format file to a USB flash drive. Before touching [ID Counter Report], you must insert the USB flash drive into the USB port.

Performing [Report Output]

1 Touch [ID Counter Report] in the [Functions] tab screen.

The [ID Counter Report] screen is displayed.

2 Select a method for [Report Output].

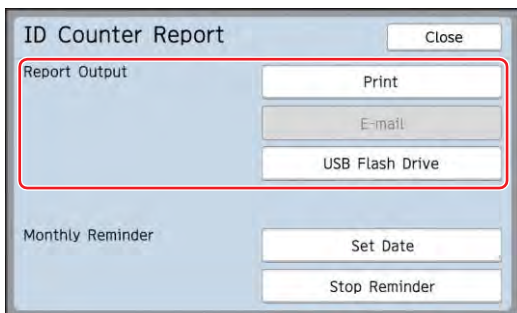

■ [Print]

Touch this button to print the total count report on this machine.

■ [E-mail]

Touch this button to send the CSV format file to the e-mail addresses that have been specified in advance.



If [E-mail] is not displayed, special settings are required. For more information, consult your dealer or authorized service representative.

If [E-mail] is grayed out, the required settings have not been performed. For the setting procedure, see [ID Counter Report] (A 98).

Setting the notification day for total count output

You can display the report screen for [Report Output] (A 157) on the specified date of every month.

1 Touch [ID Counter Report] in the [Functions] tab screen.

2 Touch [Set Date].

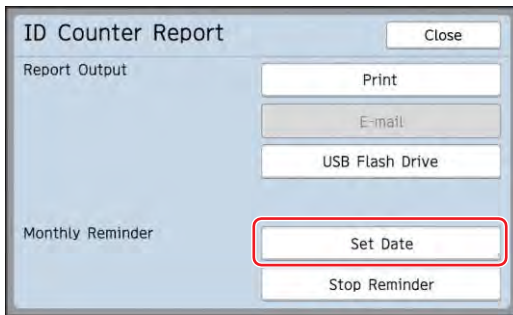

3 Touch [ON].

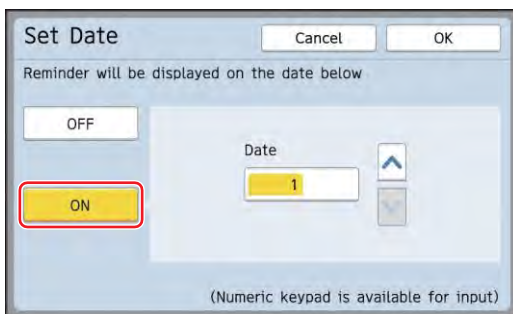

4 Set the notification day.

You can set the date using either of the following methods.

- Entering a numeric value using the numeric keys.
- Touching [G] or [F].



B When you set any date from [29] to [31], the report screen is displayed on the last day of the month if the specified date does not exist in the month, for example, February.

5 Touch [OK].

The [ID Counter Report] screen is displayed.

6 Touch [Close].



B Once you specify a date for [Set Date], a warning screen is displayed each time the power is turned on until [Report Output] (A 96) is performed. If you do not want to perform [Report Output] in the current month, touch [Stop Reminder] in the [ID Counter Report] screen. The warning screen is not displayed until the notification day of the next month.

Sending E-Mails of [ID Counter Report]

You can send the total count report of [ID Counter Report] (A 96) to the e-mail addresses that have been specified in advance. For example, this function is useful to notify the usage status to personnel, such as an in-house manager.

 **This machine must be connected to the computer via a network.**

Presetting

1 Check that [E-mail] is displayed in the [ID Counter Report] screen of this machine.

The [ID Counter Report] screen is displayed when you touch [ID Counter Report] in the [Functions] tab screen. [E-mail] is grayed out as the required settings have not yet been completed.

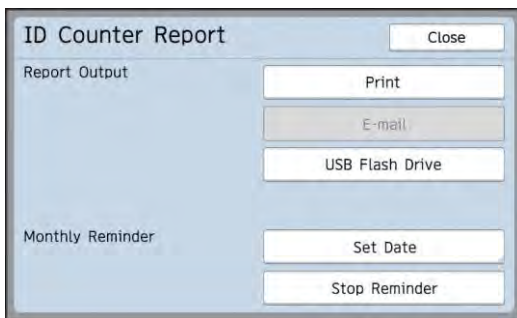

 **If [E-mail] is not displayed, special settings are required. For more information, consult your dealer or authorized service representative.**

 **When [E-mail] is not grayed out and the [E-mail] button is available, the required settings have been completed. In this case, you can send an e-mail and you do not have to perform the following steps 2 to 9 in this section.**

2 Access the RISO Console from the computer.

(A 130 “Accessing RISO Console”)

3 Log in to the RISO Console.

(A 130 “Logging in”)

4 Click [Network].

(A 133 “[Network] Menu”)

5 Click [SMTP Setting].

Set [Use] for [SMTP Authentication].

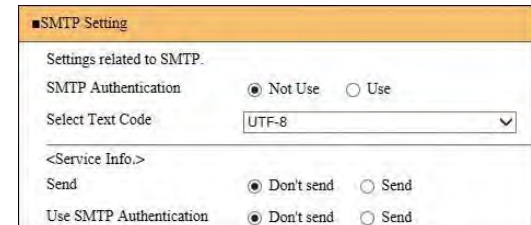

7 Perform the required settings for [Counter Info. Mail].

Scroll down the screen until the setting items for [Counter Info. Mail] are displayed.



For the SMTP server settings, please contact your network administrator.

■ [Send]

Select [Send].

■ [Use SMTP Authentication]

Select either option as necessary.

■ [User name]

When you have selected the [Use] option for [Use SMTP Authentication], enter the user name for SMTP authentication.

■ [Password]

When you have selected the [Use] option for [Use SMTP Authentication], enter the password for SMTP authentication.

■ [SMTP Server Name]

Enter the SMTP server name.

■ [Sender Address]

Enter an e-mail address of a person, such as a person in charge of managing this machine.

■ [Receiver Address 1], [Receiver Address 2]

You can specify up to two e-mail destinations.

■ [Port No.]

Enter the port number of the SMTP server.

■ [Subject]

Enter a subject for the e-mail as necessary.

■ [Message (Add Comment)]

Enter the body of the e-mail as necessary.

■ [Signature]

Enter a signature to be contained in the body of the e-mail as necessary.

■ [Send Transmission Result to Administrator]

When you select [Send], the result of e-mail transmission (success or failure) is sent to the address specified in [Administrator Address].

■ [Administrator Address]

If you select the [Send] option for [Send Transmission Result to Administrator], enter the destination address for the result of e-mail transmission.

■ [Subject]

Enter a subject for the e-mail that indicates the result of e-mail transmission as necessary.

■ [Signature]

Enter a signature to be contained in the body of the e-mail that indicates the result of e-mail transmission as necessary.

8 Click [OK] located at the bottom of the screen.

The settings that you changed are applied.

9 Check that the [E-mail] button is available in the [ID Counter Report] screen of this machine.

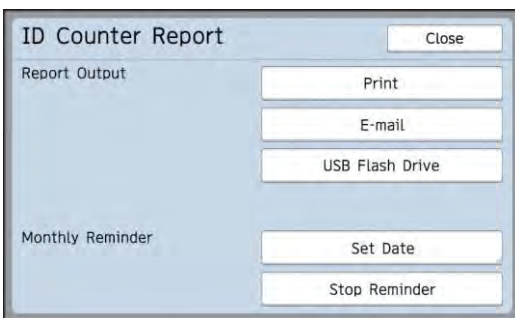

B Once you have performed the settings on the RISO Console, you can change the settings in [Copy Count Mail] (A 116) under [Admin.] as well.

Sending e-mail



B Perform the procedure of “Presetting” (A 98) in advance.

1 Touch [E-mail] in the [ID Counter Report] screen.

The e-mail is sent to the preset e-mail addresses.

After the e-mail has been sent, the basic screen is displayed.

Sending E-Mails of the Operation History [Service Info. Mail]

You can send the operation history data that is stored in this machine to e-mail addresses that have been specified in advance.



This machine must be connected to the computer via a network.

Presetting

1 Check that [Service Info. Mail] is displayed in the [Functions] tab screen of this machine.

[Service Info. Mail] is grayed out as the required settings have not yet been completed.

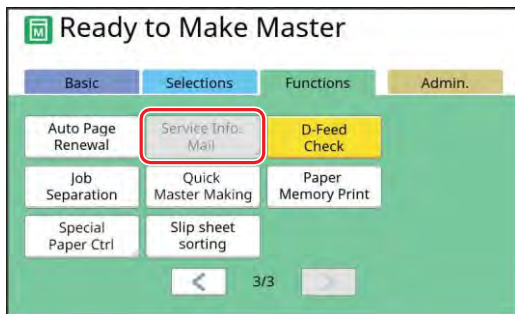

If [Service Info. Mail] is not displayed, special settings are required. For more information, consult your dealer or authorized service representative.



When [Service Info. Mail] is not grayed out and the [Service Info. Mail] button is available, the required settings have been completed. In this case, you do not have to perform the procedure of "Presetting".

2 Access the RISO Console from the computer.

(A 130 "Accessing RISO Console")

3 Log in to the RISO Console.

(A 130 "Logging in")

4 Click [Network].

(A 133 "[Network] Menu")

5 Click [SMTP Setting].

6 Set [Use] for [SMTP Authentication].

7 Perform the required settings for [Service Info.].



For the SMTP server settings, please contact your network administrator.

■ [Send]

Select [Send].

■ [Use SMTP Authentication]

Select either option as necessary.

■ [User name]

When you have selected the [Use] option for [Use SMTP Authentication], enter the user name for SMTP authentication.

■ [Password]

When you have selected the [Use] option for [Use SMTP Authentication], enter the password for SMTP authentication.

■ [SMTP Server Name]

Enter the SMTP server name.

■ [Sender Address]

Enter an e-mail address of a person, such as a person in charge of managing this machine.

■ [Receiver Address 1] (fixed)

The e-mail address of the department in charge in RISO is set. You cannot change this address.

■ [Receiver Address 2]

You can specify any e-mail destination.

■ [Port No.]

Enter the port number of the SMTP server.

■ [Subject]

Enter a subject for the e-mail as necessary.

■ [Message (Add Comment)]

Enter the body of the e-mail as necessary.

■ [Signature]

Enter a signature to be contained in the body of the e-mail as necessary.

■ [Send Transmission Result to Administrator]

When you select [Send], the result of e-mail transmission (success or failure) is sent to the address specified in [Administrator Address].

■ [Administrator Address]

If you select the [Send] option for [Send Transmission Result to Administrator], enter the destination address for the result of e-mail transmission.

■ [Subject]

Enter a subject for the e-mail that indicates the result of e-mail transmission as necessary.

■ [Signature]

Enter a signature to be contained in the body of the e-mail that indicates the result of e-mail transmission as necessary.

8 Click [OK] located at the bottom of the screen.

The settings that you changed are applied.

9 Check that the [Service Info. Mail] button is available in the [Functions] tab screen of this machine.



B Once you have performed the settings on the RISO Console, you can change the settings in [Service Info. Mail] (A 116) under [Admin.] as well.

Sending e-mail



B Perform the procedure of “Presetting” (A 100) in advance.

1 Touch [Service Info. Mail] in the [Functions] tab screen.

A confirmation screen is displayed.

2 Touch [OK].

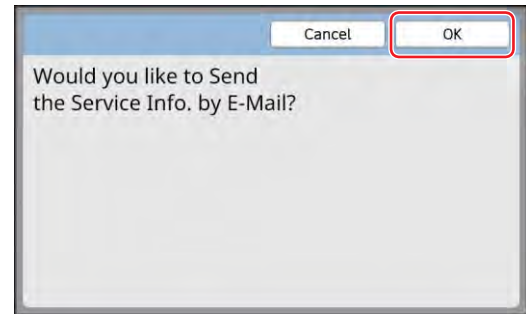

After the e-mail has been sent, the basic screen is displayed.



Chapter 6

Functions for Scanning

Functions for Scanning

For the details and setting procedure of each function, see the pages that are specified as a reference.

! The original data saved in scan mode is converted to the file format specific to this machine. Data is not saved in a general purpose file format such as PDF or JPEG. (A 38 “Saving Paper Original as Data”)

■ Functions for setting basic information

[File Name] (A 105)
 You can set the storage data name that is to be displayed.
 The name of the storage data is displayed in the [Storage Selection] screen or the [USB Job List] screen.

[Directory] (A 105)
 You can specify the folder into which the data is to be saved in [Storage] or [USB].

[Owner] (A 106)
 You can set the name of the owner of the storage data.
 The name of the storage data is displayed in the [Storage Selection] screen or the [USB Job List] screen.

■ Functions related to image processing

[Image] (A 47)
 You can set the processing that is suitable for the type of original.



[Dot Process] (A 49)
 You can set the processing method to express the gradation of a photo.

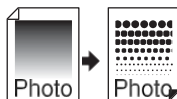

[Contrast Adj] (A 49)
 You can change a blurry photo to a sharp final output.

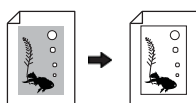

[Tone Curve] (A 50)
 You can adjust the tone of bright parts and dark parts in originals such as a photo.



[Contrast] (A 50)
 You can adjust the contrast according to the paper color and the tint of the original.

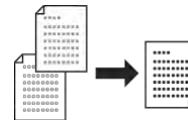

[Book Shadow] (A 51)
 You can erase or reduce the shadow in the binding section of books.

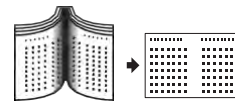

■ Functions related to layout

[Size] (A 53)
 You can enlarge or reduce the size of the original.

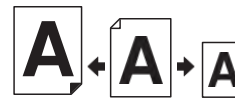

[Format] (A 107)
 You can select the paper size of the storage data.

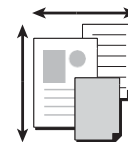

[Multi-Up Print] (A 56)
 You can lay out multiple originals on a single sheet of paper.

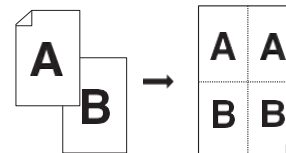

[2 Up] (A 60)
 You can lay out two copies of an original side by side on a single sheet of paper.

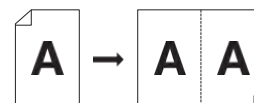

■ Other functions

[Preview] (A 63)
 You can check the output image before saving.

Setting the Name of the Original Data to be Displayed [File Name]

You can set the name of the original data that is to be displayed.
The set [File Name] is displayed in the [Storage Selection] screen or the [USB Job List] screen.
(A 66 “Managing the Saved Original Data [Storage], [USB Job List]”)

- 1 Touch [File Name] in the scan basic screen.

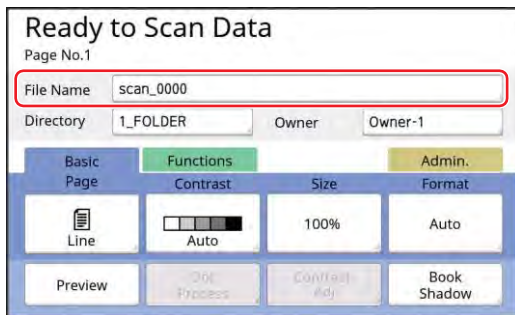

- 2 Change the data name in the [Rename] screen.

(A 24 “[Rename] screen”)

- 3 Touch [OK].

Setting the Directory of the Original Data [Directory]

Set the directory of the original data.
You can specify the folder into which the data is to be saved in [Storage] or [USB].
(A 38 “Saving Paper Original as Data”)



BWhen the optional RISO Controller IS300 is connected, you cannot change [Directory].

- 1 When you want to save data on a USB flash drive, insert the USB flash drive into the USB port.

- 2 Touch [Directory] in the scan basic screen.

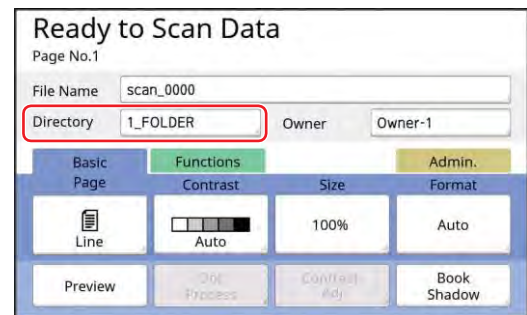

- 3 Touch [Storage] or [USB].

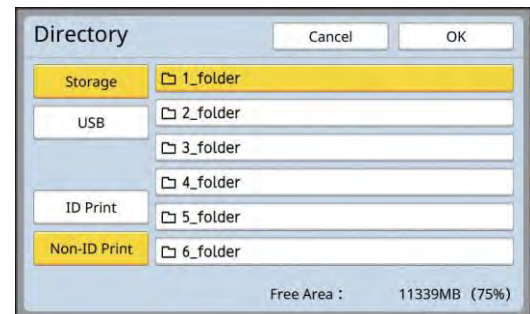

If no USB flash drive is inserted, you cannot select [USB].

- 4 Touch [ID Print] or [Non-ID Print].



BThese options are displayed when [High/Full Management] is set in [User Management] (A 122) under [Admin.].

Setting	Description
[ID Print]	The data is saved in the list of [ID Print Job] under [Storage] or [USB]. The original data that is saved in this list is displayed only when the same person as the user who has saved the data performs the authentication operation. This function is useful when you want to control highly confidential originals.
[Non-ID Print]	The data is saved in the list of [Non-ID Print] under [Storage] or [USB]. The original data that is saved in this list is always displayed when someone performs the authentication operation.

5 Touch the folder to which the data is to be saved.



B You can change the name of the [Storage] folder in [Folder Renaming] (A 114) under [Admin.].

B You can change the name of the [USB] folder in the RISO USB PRINT MANAGER.

B You can save up to 250 files of original data in one folder.

6 Touch [OK].

Setting the Name of the Person Who Saves the Original Data [Owner]

The [Owner] setting is provided in order to distinguish the person who has saved the original data. The set owner name is displayed in the [Storage Selection] screen or the [USB Job List] screen. (A 66 “Managing the Saved Original Data [Storage], [USB Job List]”)

Setting [Owner]

1 Touch [Owner] in the scan basic screen.

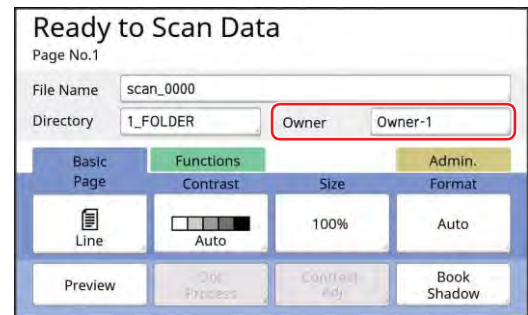

2 Touch the owner name that you want to set.



The setting is changed and the scan basic screen is displayed.

Changing the owner name

You can change the owner name as desired.

1 Touch [Owner] in the scan basic screen.

2 Touch [Rename] in the [Owner] screen.

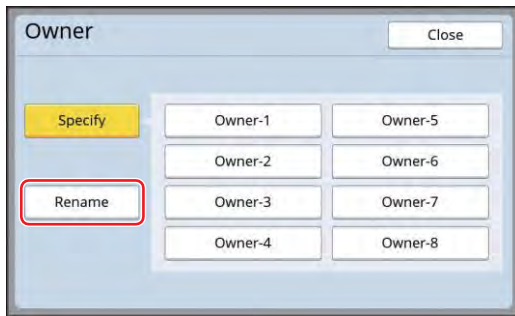

3 Touch the owner whose name you want to change.

4 Change the owner name in the [Rename] screen.

(A 24 "[Rename] screen")

5 Touch [OK].

Setting the Saving Size of the Original Data [Format]

You can set the saving size in the following cases:

- If the size of an original has not been automatically detected
- If you want to save original data with a size that is different from the original size



This item is set to [Auto] by default. It is not necessary to change the setting when a standard size original (A4, B5, etc.) is placed on the optional auto document feeder as the size is automatically detected.

You cannot use [Auto] with the following functions.

- C[Multi-Up Print] (A 56)
- C[2 Up] (A 60)

1 Touch [Format] in the scan basic screen.

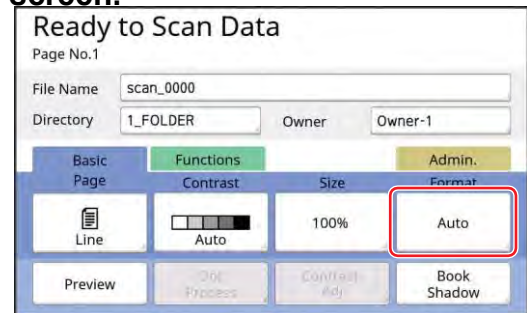

2 Touch the size that you want to set.

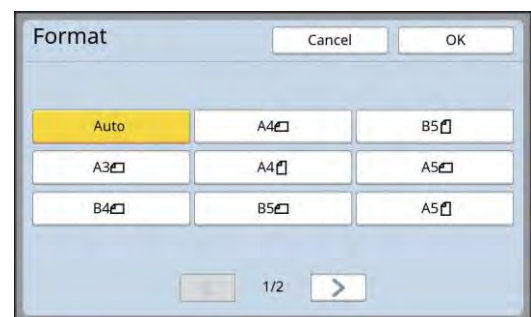

3 Touch [OK].



Chapter 7

Setting the Operation Conditions

Setting the Operation Conditions [Admin.]

You can change the default values and set the system control-related settings in order to make this machine more convenient for use.

Displaying the [Admin.] screen

1 Touch [Admin.] in the basic screen.

B If the [Admin.] tab is not displayed, consult your dealer or authorized service representative.

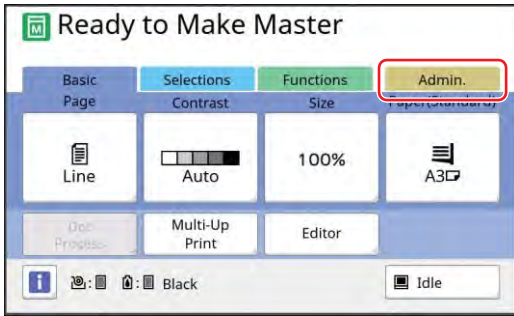

The [Admin.] tab screen is displayed.

2 Touch [OK].

B Touching [OK] resets the functions that are set in the current mode such as master making, print, or scan mode.

B When an authentication screen is displayed, perform the authentication operation as an administrator. General users cannot enter the [Admin.] screen.
(▲ 122 “Identifying the User [User Management]”)

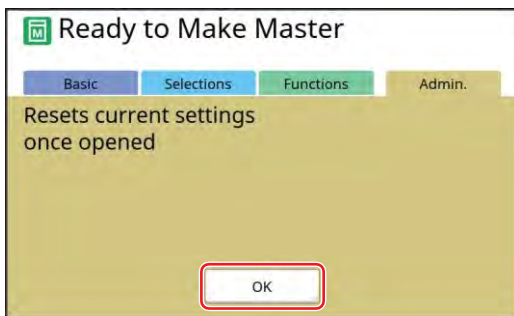

The [Admin.] screen is displayed.

3 Touch the button of the item that you want to set.



- 1 Display access buttons
Touching a button allows you to filter the items to be displayed by category.
- 2 Item buttons
Some buttons display a setting screen when they are touched, and other buttons switch between on and off when they are touched.
- 3 Description
For some items, the current settings are displayed.

Exiting the [Admin.] screen

1 Touch [Exit].

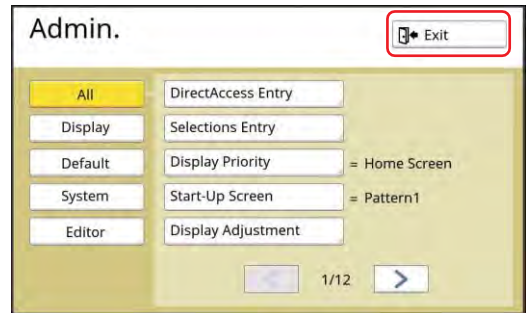

The basic screen is displayed.

List of setting items

- The factory default settings are underlined in the following list.
- The items marked with an asterisk (*) are displayed only when an optional accessory is installed.

■ Display

This screen is used for the settings related to the display of the touch panel screens.

Setting item	Description
[DirectAccess Entry] You can register the frequently used functions in the [Basic] tab screen for each mode.	A 117 "DirectAccess Entry"
[Selections Entry] You can register the frequently used functions in the [Selections] tab screen for each mode.	A 118 "Selections Entry"
[Display Priority] You can change the screen that is displayed after this machine has started up.	Home Screen, RISO Print, Scanning
[Start-Up Screen] You can change the animation pattern that is displayed when this machine starts up.	<u>Pattern1</u> , Pattern2
[Display Adjustment] You can adjust the display on the touch panel screens. BWhen [ECO mode] (A 115) is set to [ON], [Backlight Lightness] is fixed to [-2].	[Backlight Lightness]: -2 to <u>0</u> to +2
[Job list display] You can change the method for displaying the long file names on the screens that display a list of original data ([Job List], [Storage Selection], and [USB Job List]).	<u>From top</u> , From bottom
[Metric/Inch Switch] (not displayed for models other than SF9450EIIU) You can switch the unit to be used for the screen display. The types of papers to be handled also switch in accordance with the displayed unit. When [inch] is selected: Legal, Ledger, etc. When [mm] is selected: A3, B4, etc.	<u>inch</u> , mm
[Displayed Language] You can change the language to be displayed on the screen.  BWhen changing the setting, consult your dealer or authorized service representative.	#1 and on A number is assigned to each language. You can change the displayed language by selecting the number of the language that you want to display.
[Service contact] When this item is set to [Displayed], [Contact] is displayed in the service call error (A 152) screen. For the contact information, consult your dealer or authorized service representative.	<u>No display</u> , Displayed [TEL:] [FAX:]
[Supply contact] When this item is set to [Displayed], [Contact] is displayed in the consumables error (A 152) screen. For the contact information, consult your dealer or authorized service representative.	<u>No display</u> , Displayed [TEL:] [FAX:]

■ Default

You can change the default values (values when the power is turned on or is reset) for various settings.

Setting item	Description
[Image Processing] You can change the default setting of [Image] (A 47).	<u>Line</u> , Photo (Standard, Portrait), Duo (Standard, Line, Photo, Shadow off) Pencil (Darker, Lighter)
[Scanning Contrast] You can change the default setting of [Contrast] (A 50).	[Contrast Range]: Lighter, <u>Standard</u> , Darker [Contrast]: <u>Auto</u> , 1, 2, 3, 4, 5
[Reproduction Size] You can change the default setting of [Size] (A 53).	<u>100%</u> , Auto
[Print Speed] You can change the default setting of the print speed (A 72). BWhen [ECO mode] (A 115) is set to [ON], [Print Speed] is fixed to [3].	1, 2, <u>3</u> , 4, 5
[Print Density] You can change the default setting of the print density (A 73). BWhen [ECO mode] (A 115) is set to [ON], [Print Density] is fixed to [1].	[Print Density Level]: Lighter, <u>Standard</u> , Darker [Print Density]: 1, 2, <u>3</u> , 4, 5
[ADF Auto Process] * <ul style="list-style-type: none"> While this is set to [ON], when an original is placed on the optional auto document feeder, [Auto Process] (A 25) is automatically switched to on. While this is set to [OFF], the setting of [Auto Process] is not switched even when an original is placed on the auto document feeder. 	OFF, <u>ON</u>
[ADF Semi-Auto] * You can change the default setting of [ADF Semi-Auto] (A 64) when the optional auto document feeder is installed.	<u>OFF</u> , ON
[Auto Process Mode] You can change the default setting of [Auto Process] (A 25).	<u>OFF</u> , ON
[Double Feed Check] You can change the default setting of [D-Feed Check] (A 81).	OFF, <u>ON</u>
[Slip sheet sort set.] You can change the default setting of [Slip sheet sorting] (A 89). BOnly either [Job Separation] or [Slip sheet sort set.] can be turned on.	<u>OFF</u> , ON
[Job Separation] * You can change the default setting of [Job Separation] (A 89) when the optional Job Separator is installed. BOnly either [Job Separation] or [Slip sheet sort set.] can be turned on.	<u>OFF</u> , ON
[Jump Wing Control] You can change the default setting of [Jump Wing Control] (A 81).  B[Jump Wing Control] is displayed only when the special paper has been set in advance. For more information, consult your dealer or authorized service representative.	<u>OFF</u> , ON

Setting item	Description
[Paper Ejection Adj] You can change the default setting of [Paper Eject Adj] (A 77).	[Separation Fan]: OFF, 1, 2, <u>3</u> , 4 [Suction Fan]: 1, 2, <u>3</u> , 4
[Scan Data Folder] You can change the default setting of [Directory] (A 105) in the scanning mode.	<u>1</u> to 6_FOLDER
[Quick Master Making] You can change the default setting of [Quick Master Making] (A 53).	<u>OFF</u> , ON

■ System

You can change the settings that are related to the operation and control of this machine.

Setting item	Description
<p>[Custom Paper Entry] When using a paper other than the standard size paper, register the paper size in advance.</p>	A 119 "Custom Paper Entry"
<p>[Fixed Scan Size] If you use [Auto] under [Size] (A 53) when the original size cannot be detected *, the range specified in [Fixed Scan Size] is scanned as the original size. * This machine cannot detect the original size in the following cases:</p> <ul style="list-style-type: none"> • When an original is placed on the glass platen • When an original other than the standard size is placed on the optional auto document feeder 	Type: mm OFF, A3, B4, A4, A4R, B5, B5R, Foolscap Type: inch OFF, Ledger, Legal, Letter, LetterR, Statement, StatementR
<p>[Paper Size Detection] Specify how the standard paper, of which size is similar to the size of the original, will be processed on this machine when it is placed on the paper feed tray.</p> <ul style="list-style-type: none"> • When [Confirmation Screen Display] is set to [Displayed], press the [START] key on the basic screen for master making or printing. Then, the confirmation screen for selecting the paper size will be displayed. • When [Confirmation Screen Display] is set to [No display], the paper size is automatically recognized as the size specified in [Paper Size 1] or [Paper Size 2]. 	[Confirmation Screen Display]: <u>No display</u> , Displayed [Paper Size 1]: <u>C4</u> , C5-R [Paper Size 2]: C6, <u>DL</u>
<p>[Folder Renaming] You can change the folder name of [Storage].</p>	1 to 6_FOLDER
<p>[External Controller] To connect the optional RISO Controller IS300, set this item to [ON]. When this item is set to [ON], the following functions are disabled.</p> <ul style="list-style-type: none"> • [Storage] (A 66) • [USB Job List] (A 66) • Printing by connecting the computer using the USB cable <p>For more information on how to use the IS300, see the user's guide for the IS300.</p>	OFF, ON
<p>[Network Settings (IPv4)] This item is set for connecting this machine to the network. Set this item when you allocate an Internet Protocol version 4 address to this machine.</p>	Manual Input, <u>Use DHCP</u> A 121 "Network Settings (IPv4)"
<p>[Network Settings (IPv6)] This item is set for connecting this machine to the network. Set this item when you allocate an Internet Protocol version 6 address to this machine.</p>	Manual, Stateless, <u>Stateful</u> A 121 "Network Settings (IPv6)"
<p>[LAN Interface] You can specify the physical network type. Leave [AUTO] selected for most cases.</p>	<u>AUTO</u> , 10HALF, 10FULL, 100HALF, 100FULL
<p>[Margin-Plus Rate] You can change the reduction rate that is applied to the setting of [Margin+] (A 53).</p>	90 to <u>94</u> to 99%
<p>[Clock/Calendar] You can adjust the internal clock of this machine (A 137).</p>	Year, Mnth, Day, Hour, min

Setting item	Description
<p>[Multi-Up Interval] When [Multi-Up Print] (A 56) is set to on, if a certain amount of time has elapsed without the next original being placed, master making starts automatically. This certain amount of time is referred to as [Multi-Up Interval].</p>	15 seconds, 30 seconds
<p>[Reserve Period] Even if this machine has been left untouched after the operation stops, master making of the received original data does not start until a certain amount of time has elapsed. This certain amount of time is referred to as a “reserve period”.</p>	OFF, 15 seconds, 30 seconds, 60 seconds
<p>[Ex. Reserve Period] You can change the extended time of [Reservation] (A 92).</p>	5 minutes, 10 minutes, 30 minutes
<p>[Auto Clear] You can configure the setting so that the setting ([Image] or [Print Position]) that was changed on the control panel returns to the default if this machine is left for a given period of time. You can also change the time before the value is returned to its default setting.</p>	OFF, ON [Waiting Time]: 1 to 5 to 60 minutes
<p>[Auto Sleep] You can set this machine to go into sleep mode, in which power consumption can be reduced, if this machine has not been used for a certain amount of time. Even while this machine is in sleep mode, this machine can receive the original data from the computer. BWhen [Protect] (A 128) is set to [ON], [Auto Sleep] cannot be set to [OFF]. Also, [Waiting Time] is fixed to [1].</p>	OFF, ON [Waiting Time]: 1 to 5 to 99 minutes
<p>[Auto Power-OFF] You can set the power so it is turned off if this machine has not been used for a certain amount of time.</p>	OFF, ON [Waiting Time]: 1 to 60 to 99 minutes
<p>[Power-OFF Schedule] You can set this machine power to be turned off at the specified time. BThe power does not turn off if this machine is being used or receiving original data when the specified time has arrived.</p>	OFF, ON [Hour]: 0 to 23 [min]: 0 to 59
<p>[ECO mode] This item is set for reducing the power consumption during printing. When this item is set to [ON], this machine enters the following states:</p> <ul style="list-style-type: none"> • Printing is performed at a lower pressure than when this item is set to [OFF]. • The screen display is dimmer than when this item is set to [OFF]. • Neither [Print Speed] nor [Print Density] (A 112) can be changed any longer. • The [KECO mode] icon is displayed in the message area in the basic screen. <p> BWhen [Ink Saving] is set to on, the [SInk Saving] icon is prioritized over the [KECO mode] icon on the display.</p>	OFF, ON
<p>[User Management] This setting enables individual user management and enhanced security.</p>	A 122 “User Management”

Setting item	Description
[Protect] This item is set for controlling the used masters.	A 128 "Protect"
[Auto Idling] You can set [Idling Action] (A 92) to be performed automatically during the next master making if the print drum (cylinder) has not been used for a certain amount of time. [Idling Action] is an operation that ensures the ink usability and stability. To increase the ink usability and stability, set a higher value in [Rotation].	OFF, <u>ON</u> [Non-Use Time]: 1 to <u>12</u> hour [Rotation]: <u>1</u> to 3
[Auto Page Renewal] You can set [Renew Page] (A 76) to be performed automatically when the number of printed copies has reached the specified number. You can also specify the number of proof copies after master making is performed again.	OFF, <u>ON</u> [Auto Renewal Point]: 1 to <u>1000</u> to 9999 [Sample Copy Output]: 0 to <u>3</u> to 99
[Minimum Print Q'ty] You can set master making to be performed only when the entered number of printed copies is more than the specified number. BYou can lock the setting of [Minimum Print Q'ty], so that it cannot be changed. For more information, consult your dealer or authorized service representative.	OFF, <u>ON</u> 2 to 99
[Service Info. Mail] This item is set for sending e-mails by [Service Info. Mail] (A 100). BThis setting item may not be displayed depending on your system configuration. For more information, consult your dealer or authorized service representative.	A 100 "Sending E-Mails of the Operation History [Service Info. Mail]"
[Copy Count Mail] This item is set for sending e-mails by [ID Counter Report] (A 98). BThis setting item may not be displayed depending on your system configuration. For more information, consult your dealer or authorized service representative.	A 98 "Sending E-Mails of [ID Counter Report]"
[Initialize Network] You can restore the settings of [Network Settings (IPv4)], [Network Settings (IPv6)], and [Network] for the RISO Console (A 133) to the factory default settings.	Touching [Initialize Network] displays an execution confirmation screen. Touch [OK] to execute initialization.
[Beep Sound] <ul style="list-style-type: none"> • When this item is set to [OFF], no buzzer will occur. • When this item is set to [Limited], the buzzer sounds when: <ul style="list-style-type: none"> • an error occurs; • the machine is placed into the state in which the print drum can be pulled out; or • the print drum, master disposal box, or master making unit is loaded. • When this item is set to [ON], in addition to the above state, but also operation sounds for items such as keys and buttons, and confirmation sounds for the completion of an operation will occur. 	OFF, Limited, <u>ON</u>

■ Editor

This is a setting item for [Editor].

Setting item	Description
[Print Colors]	See the user's guide for the RISO Editor.
[Page Orientation]	

Registering Frequently Used Functions in the [Basic] Tab Screen [DirectAccess Entry]

You can register frequently used functions in the Direct Access Area in the basic screen.

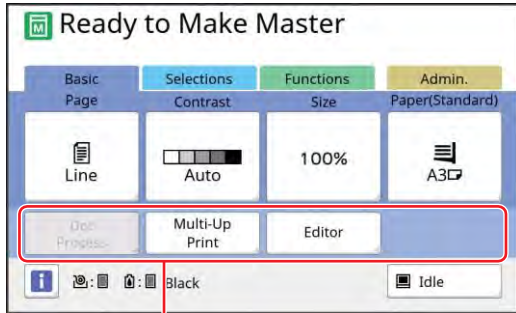

Direct Access Area

You can register a function to the Direct Access Area in the following modes.

- Master making mode
- Printing process mode
- Scan mode



BWhen an optional device is connected, some functions are automatically registered in the Direct Access Area.

BWhen [User Management] is set, the functions that are displayed in the Direct Access Area can be changed for each user.

(A 94 "Registering Frequently Used Functions for Each User [My Direct Access]")

1 Touch [DirectAccess Entry] in the [Admin.] screen.

2 Touch the mode tab in which you want to register a function.

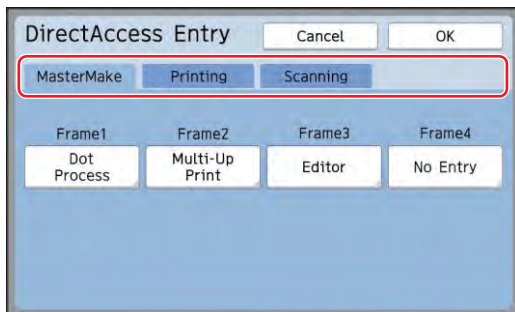

3 Touch the function button that you want to register.

You can also touch the button for which a function has already been registered to change to another function.

4 Touch the function name to be registered.



- Touch [For []] to change the display.
- If you do not want to register any function, touch [No Entry].
- You cannot touch a function name that has already been registered.

5 Touch [OK].
The [DirectAccess Entry] screen is displayed. When you want to register another function button, repeat steps 3 to 5.

6 Touch [OK].
The [Admin.] screen is displayed.

Registering Frequently Used Functions in the [Selections] Tab Screen [Selections Entry]

You can register frequently used functions in the [Selections] tab screen.



You can register the functions in the [Selections] tab screen for each of the following modes.

- Master making mode
- Printing process mode



When an optional device is connected, some functions are automatically registered in [Selections].

1 Touch [Selections Entry] in the [Admin.] screen.

The [Selections Entry] screen is displayed.

2 Touch the mode tab in which you want to register a function.

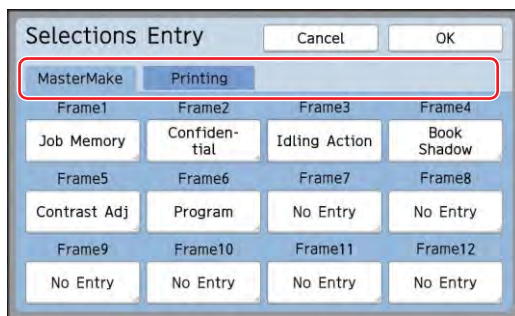

3 Touch the function button that you want to register.

You can also touch the button for which a function has already been registered to change to another function.

4 Touch the function name to be registered.



- Touch [For []] to change the display.
- If you do not want to register any function, touch [No Entry].
- You cannot touch a function name that has already been registered.

5 Touch [OK].

The [Selections Entry] screen is displayed. When you want to register another function button, repeat steps 3 to 5.

6 Touch [OK].

The [Admin.] screen is displayed.

Registering the Custom Size Paper [Custom Paper Entry]

When using paper other than the standard size paper (A 14), you need to register the paper size in advance.

You can select the registered paper sizes in [Paper Size] (A 55).

■ Paper size that can be registered

100 mm × 148 mm (3 15/16 inches × 5 13/16 inches) to 310 mm × 555 mm (12 7/32 inches × 21 27/32 inches)

- You can use papers up to a size of 310 mm × 432 mm (12 7/32 inches × 17 inches) on the standard paper receiving tray. When the optional Wide Stacking Tray is installed (A 172), you can use papers up to a size of 310 mm × 555 mm (12 7/32 inches × 21 27/32 inches). Papers may not be arranged properly depending on the paper type or paper size.
- For papers that are 436 mm (17 5/32 inches) or longer, this machine prints in extended paper mode (A 55).

Registering the paper size

1 Touch [Custom Paper Entry] in the [Admin.] screen.

2 Touch a button for which nothing has been registered.



3 Specify the paper size.

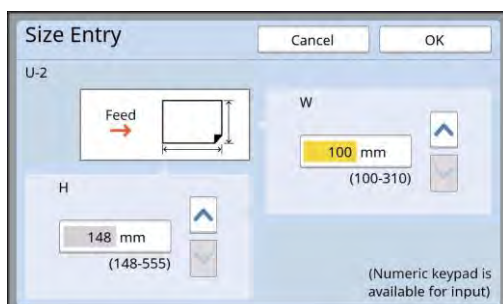

You can specify the paper size using either of the following methods.

- Entering a numeric value using the numeric keys.
- Touching [G] or [F].



B When you set [H] to any value from 436 to 555 mm (17 5/32 to 21 27/32 inches), the paper is called “extended paper”.

(A 55 “Using Custom Size Paper [Paper Size]”)

B To use extended paper, the optional Wide Stacking Tray is required.

4 Touch [OK].

The [Custom Paper Entry] screen is displayed.

Changing the paper size

1 Touch [Custom Paper Entry] in the [Admin.] screen.

2 Touch [Change].

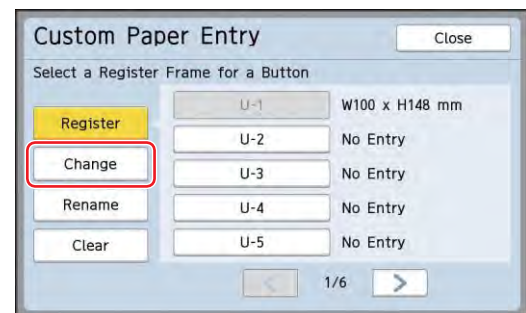

3 Touch the button of the paper that you want to change.

4 Change the paper size.

5 Touch [OK].

The [Custom Paper Entry] screen is displayed.

Changing the name of the paper size

1 Touch [Custom Paper Entry] in the [Admin.] screen.

2 Touch [Rename].



3 Touch the button whose name you want to change.

(A 24 "[Rename] screen")

4 Touch [OK].

The [Custom Paper Entry] screen is displayed.

Erasing the paper size

1 Touch [Custom Paper Entry] in the [Admin.] screen.

2 Touch [Clear].



3 Touch the button that you want to erase.

4 Touch [OK] in the confirmation screen.

The selected paper size is erased, and the [Custom Paper Entry] screen is displayed.

Connecting to the Network [Network Settings (IPv4)] [Network Settings (IPv6)]

To connect this machine to a network, perform settings such as the IP address according to the connection environment.

When connecting to the IPv4 network

Set this item when you allocate an Internet Protocol version 4 address to this machine.

- 1 Touch [Network Settings (IPv4)] in the [Admin.] screen.
- 2 Select a setting method.
Touch either [Manual Input] or [Use DHCP] according to the connection environment.

- 3 Enter a value.
You can enter a value into the active entry field. You can change the target for entry by using either of the following methods.

- Pressing the [↵] key
- Directly touching the entry field



Pressing the [C] key returns the value of the active entry field to "0".

- 4 Touch the [OK] key.
The [Admin.] screen is displayed.

When connecting to the IPv6 network

Set this item when you allocate an Internet Protocol version 6 address to this machine.

- 1 Touch [Network Settings (IPv6)] in the [Admin.] screen.
- 2 Select a setting method.
Touch either [Manual], [Stateless], or [Stateful] according to the connection environment.

- 3 Enter a value.
 - [Prefix]:
You can enter using the numeric keys.
 - Other setting items:
When you touch a button, the [Key Board] screen is displayed. Enter using the following steps.

- 1 Enter by touching the buttons on the screen.
You can also enter numbers using the numeric keys.
- 2 Touching the [OK] key displays the [Network Settings (IPv6)] screen.

- 4 Touch the [OK] key.
The [Admin.] screen is displayed.

Identifying the User [User Management]

“Authentication” means to identify the user of this machine by using the PIN code, etc., that is assigned to each user.
User identification enables individual user management and enhanced security.

It is necessary to set the following items in order to enable the authentication function.

- [Recognized by]
- [Management Level]
- [Create User]



BThe authentication function is disabled by default at the time of factory shipment as follows:

- CAny user can use this machine.
- CAny user can change [Admin.].

■ Authentication function

The authentication function is basically divided into “Machine authentication” and “ID print”.

Machine authentication

Before using this machine, it is necessary to perform the authentication operation (entry of PIN code, insertion of USB flash drive for authentication, or holding of IC card over reader).

Performing the authentication operation can limit the use of this machine to only the registered users. It can also limit the operation of [Admin.] to only the administrator.

It also enables the following functions:

- [My Direct Access] (A 94)
- [My Counter] for [Info] (A 137)
- [ID Counter Report] (A 96)
- [ID Print] in the scan mode (A 105)
- [ID Print Job] for [Storage] or [USB Job List] ¹ (A 66)

¹ The administrator can access the authentication data of any user.

ID print

If a user sets [ID print] for the printer driver, it is necessary to perform the authentication operation (entry of PIN code, insertion of USB flash drive for authentication, or holding of IC card over reader) before performing operations for the original data on this machine. Performing the authentication operation can limit the access to the original data to only the person who has set [ID print]. ²

(A 34 “Printing from Computer”)

(A 40 “Printing the Saved Original Data”)

² The administrator can access the authentication data of any user.

[Recognized by]

Select one of the following methods that is to be used for identifying the user.

- PIN Code
- USB Flash Drive
- IC Card (when the optional IC Card Reader is installed)



B Be sure to select the above setting first.

If you change [Recognized by], all of the user identification settings are erased including the settings for [Create User].

1 Touch [User Management] in the [Admin.] screen.

2 Touch [Recognized by].

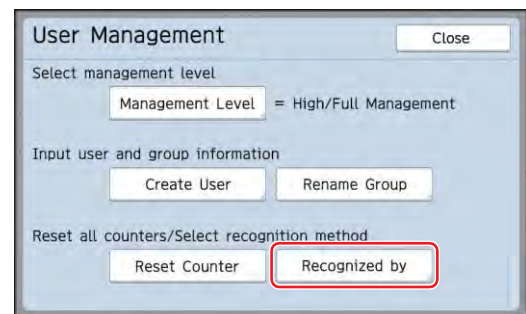

3 Touch the authentication method to be used.



B[IC Card] is displayed when the optional IC Card Reader is installed.

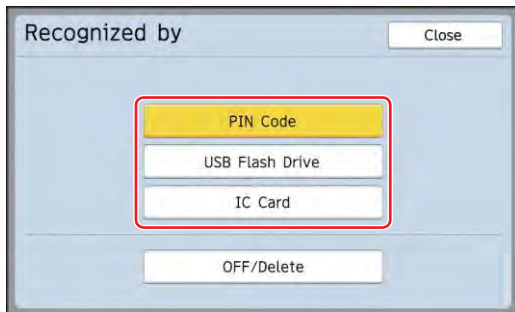

A confirmation screen is displayed.

4 Touch [OK].

[Management Level]

Set the type of authentication.



■ Set [Recognized by] in advance.

1 Touch [Management Level] in the [User Management] screen.

To display the [User Management] screen, perform steps 1 to 3 in [Recognized by] (A 122).

2 Touch the type of authentication method to be used.



■ [High/Full Management]

Both "Machine authentication" and "ID print" are available.

■ [Mid/ID Print Only]

Only "ID print" is available.

■ [Low/Admin Tab Only]

Neither "Machine authentication" nor "ID print" is available.

The operation of [Admin.] is limited to only the administrator.

3 Touch [OK].

[Create User]

Register the users who use this machine.



Set [Recognized by] in advance.

The number of users that can be registered varies depending on the [Recognized by].

[Recognized by]	Available "Authentication registration numbers"
[PIN Code] or [USB Flash Drive]	No.0 to 99
[IC Card]	No.0 to 499 *

* [ID print] (A 35) is available only for User No.0 to 99.

Those users are categorized into "administrator" and "general user".

What is "administrator"?

"Authentication registration numbers" are assigned to the users who have been registered in this machine. The user who has been registered for authentication registration number 0 is called "administrator". The administrator can use all of the functions of this machine.

Once the administrator is registered, the authentication function is enabled.



Authentication registration number

What is "general user"?

The users who have been registered for any numbers from authentication registration number 1 are called "general users". General users cannot enter the [Admin.] screen.

1 Touch [Create User] in the [User Management] screen.

To display the [User Management] screen, perform steps 1 to 3 in [Recognized by] (A 122).

2 Touch the authentication registration number to be assigned to the user.



The [Register] screen is displayed.



If no administrator is registered, you cannot register general users. Register the administrator first.



You cannot select numbers for which users have already been registered.

3 Register the information for authentication.

When using PIN code

Enter the PIN code using the numeric keys.

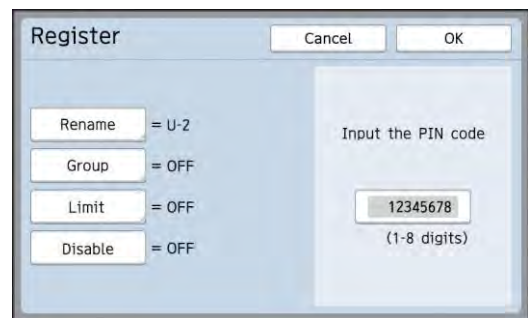

The entered number is displayed.

■ When using USB flash drive

Insert a USB flash drive that is to be registered for authentication.

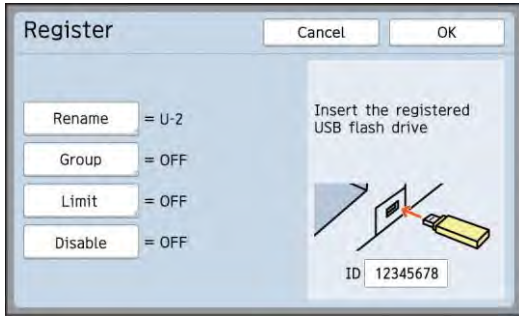

The number specific to the USB flash drive is displayed (you cannot change this number).

■ When using IC card

Hold the IC card to be registered for authentication over the reader.

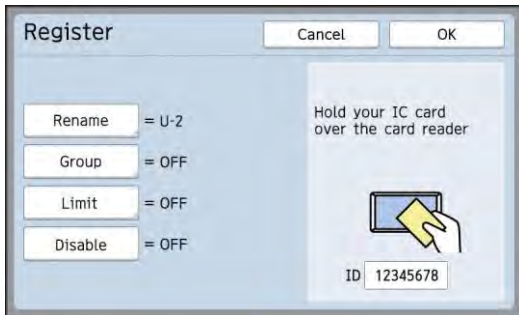

The number specific to the IC card is displayed (you cannot change this number).

4 Set the user information.

Set the following items as necessary.

■ [Rename]

You can change the user name. The name that is set here will be displayed in "USERNAME" in the CSV file that is saved in [ID Counter Report] (A 96).

(A 125 "Changing the user name")

■ [Group]

You can set the group (department, etc.) to which the user belongs. Once this item is set, the total count for each group is displayed in the CSV file that is saved in [ID Counter Report] (A 96).

(A 125 "Setting the group")

■ [Limit]

You can set the upper limit of the number of copies that the user can use for master making or printing.

(A 126 "Setting the upper limit number of copies that can be used")

■ [Disable]

You can prohibit the use of this machine by specific users.

(A 126 "Temporarily disabling the usage of this machine")

5 Touch [OK].

Remove the USB flash drive for authentication, if it is inserted.

When registration is complete, provide the following items to the user.

■ When [Recognized by] is set to [PIN Code]

- Authentication registration number
- PIN code

■ When [Recognized by] is set to [USB Flash Drive] or [IC Card]

- Authentication registration number
- USB flash drive for authentication or IC card



B The authentication registration number is required for using [ID print].

■ Changing the user name

1 Touch [Rename].

2 Enter the user name.

(A 24 "[Rename] screen")

3 Touch [OK].

The [Register] screen is displayed.

■ Setting the group

1 Touch [Group].

2 Touch the group that you want to set.



Blf no group is to be set, touch [OFF].

3 Touch [OK].

The [Register] screen is displayed.

■ Setting the upper limit number of copies that can be used

1 Touch [Limit].

2 Enter the upper limit number of copies for printing and master making.

Touch the entry field of [Limit T/C] or [Limit M/C], and then enter the upper limit number of copies using the numeric keys.

When the upper limit number of copies is set to 0, no limit is applied.



B In [Present T/C] and [Present M/C], the number of copies that the user has printed or the number of masters that the user has created up to the present are displayed, respectively.

B To clear the counter for [Present T/C] and [Present M/C], touch [T].

3 Touch [OK].

The [Register] screen is displayed.

■ Temporarily disabling the usage of this machine

1 Touch [Disable].

[Disable] turns on.



B To cancel the temporarily disabled state, touch [Disable] again.

B Administrator usage of this machine cannot be temporarily disabled.

Changing the User Information

1 Touch [Create User] in the [User Management] screen.

To display the [User Management] screen, perform steps 1 to 3 in [Recognized by] (A 122).

2 Touch [Change].

3 Touch the user that you want to change.

The [Change] screen is displayed.



B You can also change the information of the administrator.

4 Change the registered information.

Perform step 3 and the subsequent steps in [Create User] (A 124) as necessary.

Erasing the General Users

1 Touch [Create User] in the [User Management] screen.

To display the [User Management] screen, perform steps 1 to 3 in [Recognized by] (A 122).

2 Touch [Clear], and then touch the user that you want to erase.



B You cannot erase the administrator from this screen. To erase the administrator, disable the authentication function.
(A 127 “Erasing the Authentication Setting”)

3 Touch [OK].

Changing the group name

1 Touch [Rename Group] in the [User Management] screen.

To display the [User Management] screen, perform steps 1 to 3 in [Recognized by] (A 122).

2 Touch the group whose name you want to change.



3 Enter the group name. (A 24 “[Rename] screen”)

4 Touch [OK].

Clearing the Counter for All Users

You can clear [Present M/C] and [Present T/C] for all users collectively.



B Once you have cleared the counter, it is not possible to return to the status before the counter was cleared.



B To clear only the counter for a specific user, touch [T] as described in step 2 in “Setting the upper limit number of copies that can be used” (A 126).

1 Touch [Reset Counter] in the [User Management] screen.

To display the [User Management] screen, perform steps 1 to 3 in [Recognized by] (A 122).

2 Touch [OK].

Erasing the Authentication Setting

To disable the authentication function, erase all of the authentication settings including the registered administrator.



B Once you have erased the authentication settings, it is not possible to return to the status before the settings were erased.

1 Touch [Recognized by] in the [User Management] screen.

To display the [User Management] screen, perform steps 1 to 3 in [Recognized by] (A 122).

2 Touch [OFF/Delete].

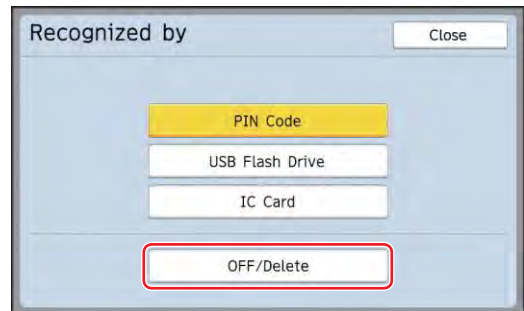

A confirmation screen is displayed.

3 Touch [OK].

All of the user authentication settings are erased and the authentication function is disabled.

Managing the Used Master [Protect]

After printing, the master that has been made is still loaded on the print drum (cylinder) in the print ready status.

When [Confidential] (A 93) is turned on, the master that has been made is discarded. Therefore, you can prevent improper printing of confidential documents.

However, as the discarded masters are accumulated in the master disposal box, there is a risk that the box could be removed by a third party with malicious intent.

In order to avoid such a risk, this machine features the [Protect] function.



B When [Protect] is set to [ON], the time that is required for switching to [Auto Sleep] (A 115) is fixed to one minute.

B When [Protect] is set to [ON], you cannot use [Renew Page] (A 76).

■ Operation when [Protect] is set to on

- After printing is complete, a confirmation screen that prompts you to execute [Confidential] is displayed.

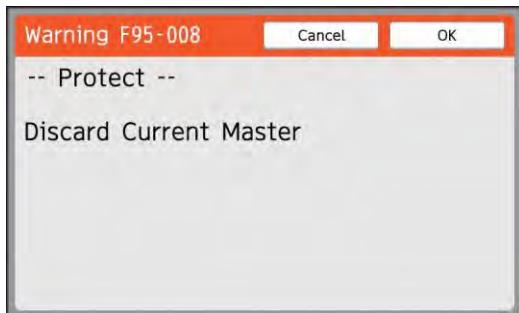

[OK]: Touch this button to discard the already made masters.

[Cancel]: Touch this button if you do not need to discard the master or you want to print further copies.

The confirmation screen is displayed in the following cases:

- When the [RESET] key is pressed.
- When the time that is set in [Auto Clear] (A 115) elapses.
- After restored from sleep mode.
- When the power is turned on.



B [Cancel] is not displayed in the following cases:

- C When a new print drum (cylinder) for which [Confidential] has not been executed is installed.
- C When this machine has been restored from sleep mode that was activated while a confirmation screen prompting you to execute [Confidential] was displayed.
- C When the power is turned on while a print drum (cylinder) for which [Confidential] has not been executed is installed.

- The master disposal box is locked so that it cannot be removed. However, you can remove the master disposal box if a master is jammed in the master disposal section or the master disposal box becomes full.



B The master disposal box can be locked with a padlock, etc., so that it cannot be removed by anyone except for the administrator. When locking, insert the padlock into the lock lever hole as illustrated below. (Purchase a commercially available padlock. The diameter of the hole for inserting the padlock is 7 mm [9/32 inches].)

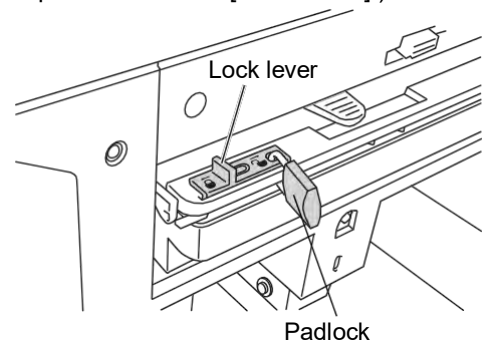

Setting [Protect]

1 Touch [Protect] in the [Admin.] screen.

[Protect] is set to [ON].

Canceling [Protect]

1 Touch [Protect] in the [Admin.] screen.

After the message "Please Wait a Moment" is displayed, [Protect] is set to [OFF].



Chapter 8

RISO Console

RISO Console

“RISO Console” is a function for remotely operating this machine using a Web browser. You can check the status of this machine and change the settings from a computer that is connected via a network.

Compatible Web browser

OS	Web browser
Windows	Internet Explorer 11 Microsoft Edge
Mac OS	Safari 6 Safari 7 Safari 8 Safari 9 Safari 10 Safari 11 Safari 12

Accessing RISO Console

1 Start up a Web browser.

2 Enter the IP address of this machine.

Entry example:

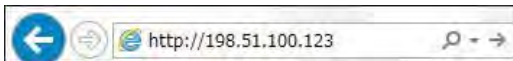

B For the IP address of this machine, contact your administrator.

3 Press the [Enter] key.

The [Monitoring] menu screen for the RISO Console is displayed.

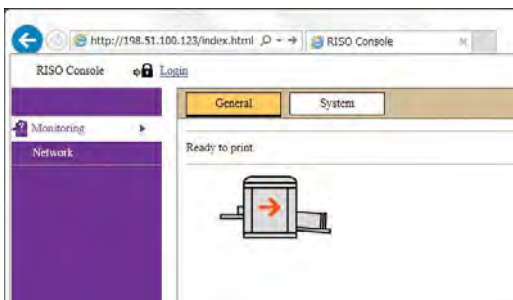

Logging in

In order to perform the following operations, it is necessary to log in to the RISO Console.

- Browsing the [Printer] menu screen
- Changing the settings on the [Network] menu screen (login is not necessary for browsing)

1 Click [Login].

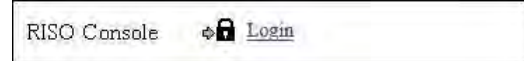

2 Enter [User name] and [Password].

[User name]

Enter “admin” (lower-case, single-byte characters).

You cannot change the user name.

[Password]

This is the password that has been set in the [User] tab screen (A131) on the RISO Console.

The password that was set by default at the time of factory shipment is “admin” (lower-case, single-byte characters).

3 Click [OK].

Logging out

1 Click [Logout].



When you log out, the user name display goes off and [Login] is displayed.

[Monitoring] Menu

You can check the status of this machine and system information, and also change the login password.

[General] tab screen

You can check the status of this machine.

Consumables Amount	Paper size	Paper finish
Standard tray	A3	Standard
Master		
Ink		

Disposal Box Space
Disposal Box

Drum Information	Size	Ink Color
Print Drum	A3	

■ Status of this machine

Shows a message such as [Ready to print.] or [Sleeping.]. If an error occurs in this machine, an error message is displayed.

■ Consumables Amount

[Standard tray]

Shows [Paper size] and [Paper finish] of papers on the paper feed tray.

[Master]

Shows the remaining amount of the masters that are set in this machine.

If the remaining amount is low, the remaining amount indicator blinks.

[Ink]

Shows the remaining amount of ink that is set in this machine.

If the remaining amount is low, the remaining amount indicator blinks.

■ Disposal Box Space

Shows the remaining amount of space in the master disposal box.

If the amount of space is low, the remaining amount indicator blinks.

■ Drum Information

Shows the size and color of the print drum (cylinder) that is set in this machine.

[System] tab screen

You can check the system information of this machine.

[System]	
Printer Name:	RISO SF9x50EII Series 000000
Model:	RISO SF9350EII
Serial No.:	00000000
MAC address:	00-00-00-00-00-00
Firmware:	RCCS 00.00.00

[Printer Information]	
Print Speed:	Level 3
Print Density:	Level 3
Resolution:	600 x 600 dpi
Copy Count:	38161
Occupied storage memory volume:	12.44MB
Free storage memory volume:	17.55MB

[Job Separator]	
Job Separator:	Unavailable

[Scanner mode]	
Scanning Level:	Auto
Originals on Auto Document Feeder:	Not installed
Mode:	Line

[User] tab screen

You can change the password for logging in to the RISO Console.

1 Click [Change password].

General	System	User
User name: admin		
Change password		

2 Enter a new password.

User > Change password
New password
<input type="text"/> - <input type="text"/> - <input type="text"/> - <input type="text"/> (0-16 characters)
Input again for confirmation.
New password
<input type="text"/> - <input type="text"/> - <input type="text"/> - <input type="text"/>
OK Cancel

3 Click [OK].

The [Done] screen is displayed.

4 Click [OK].

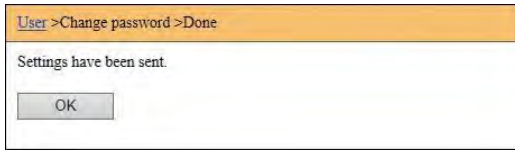

[Printer] Menu

You can check the original data on this machine and also change the folder name of [Storage].

[Active] tab screen

You can check a list of the original data that is currently being processed in this machine.



- Clicking the heading line ([Job name] [Owner] [Received]) changes the sorting order.
- You can select the number of items to be listed from [Show 50 items] and [Show 100 items].

[Storage] tab screen

You can check the original data that is stored in [Storage] on this machine.

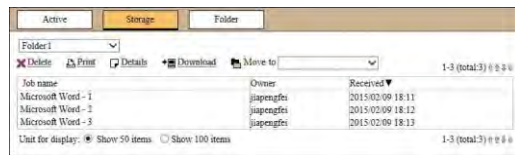

- Clicking the heading line ([Job name] [Owner] [Received]) changes the sorting order.
- You can select the number of items to be listed from [Show 50 items] and [Show 100 items].

■ [Delete]

Click the job name of the original data that you want to delete. The original data is highlighted. When you click [Delete], the highlighted original data is deleted.

■ [Print]

Click the job name of the original data that you want to print. The original data is highlighted. When you click [Print], the highlighted original data is printed.

■ [Details]

Click the job name of the original data for which you want to check the details. The original data is highlighted. When you click [Details], the detailed information of the highlighted original data is displayed. You can also change [Job name] and [Owner] of the original data.

■ [Download]

Click the job name of the original data that you want to download onto a computer. The original data is highlighted. When you click [Download] and perform the operation according to the instructions on the screen, the highlighted original data is downloaded onto the computer.



B You can only download the original data that is saved in the unique file format for this machine.

■ [Move to]

Click the job name of the original data that you want to move. The original data is highlighted. When you select the destination folder from the [Move to] menu, the highlighted original data is moved to the folder.

[Folder] tab screen

You can change the folder name of [Storage].

1 Click the folder whose name you want to change.

2 Enter a new folder name in the [Folder Name] field.

3 Click [OK].

The [Done] screen is displayed.

4 Click [OK].

[Network] Menu

You can check and change the settings that are related to the network connection of this machine.

When you click an item, the setting screen for the relevant item is displayed.

[Network setting] screen

This screen is used for the connection settings of this machine to the network.

Clicking [OK] updates the changes.

[SNMP Setting] screen

This screen is used for the SNMP (Simple Network Management Protocol) settings. Set in accordance with the network environment.

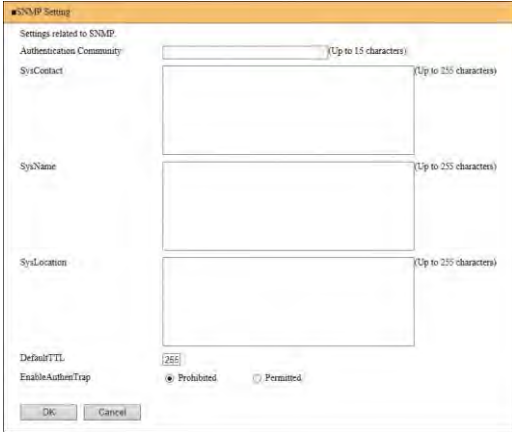

Clicking [OK] updates the changes.

[SMTP Setting] screen

This screen is used for the SMTP (Simple Mail Transfer Protocol) settings.

Perform the settings when using [E-mail] for [ID Counter Report] (A 98) and [Service Info. Mail] (A 100).

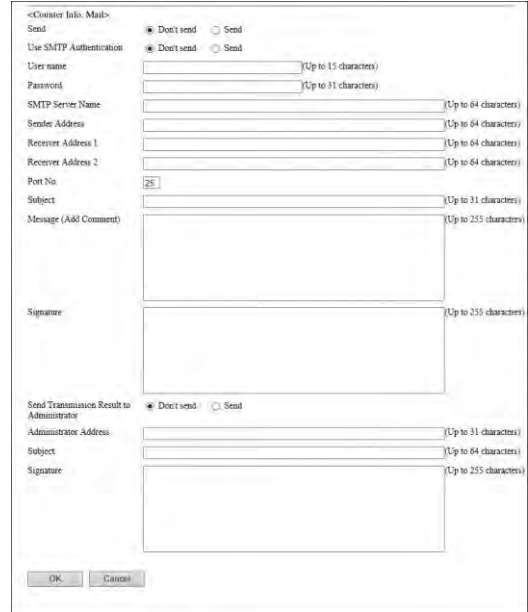

Clicking [OK] updates the changes.



B This screen may not be displayed depending on your system configuration. For more information, consult your dealer or authorized service representative.



Chapter 9

Replacing Consumables

Checking the Remaining Amount of Consumables

The information of the consumables is displayed in the status area of the basic screen.

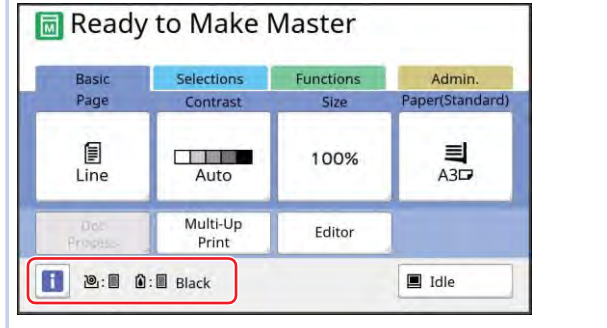

■ [i] icon

The color of the [i] icon shows the status of this machine.

Display	Description
(Blue)	This machine is operating properly.
(Yellow)	This machine is operating properly, but the function (remaining amount display, etc.) that requires the information from the consumables cannot be activated. (A 159 "When the [Consumables Information Input Wizard] screen is displayed")

■ Display of information on consumables

Display	Description
	Shows the remaining amount of the master roll that is set in this machine. BIf this machine could not acquire the information from the master roll, the remaining amount is not displayed and the icon blinks.

Display	Description
	Shows the color name and remaining amount of the ink that is set in this machine. BIf this machine could not acquire the information from the ink cartridge, the remaining amount is not displayed and the icon blinks. The color is indicated as [Black] or [Color]. (A 159 "When the [Consumables Information Input Wizard] screen is displayed")

You can check for more detailed information using the following steps.

1 Touch [i] in the basic screen.

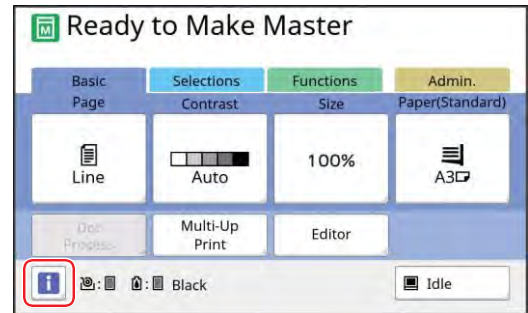

2 Check the displayed information.

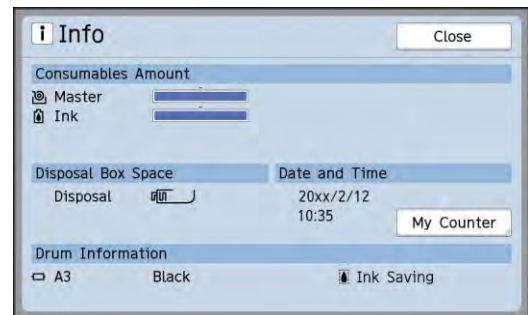

■ [Consumables Amount]

Shows the remaining amounts of the master roll and ink using the remaining amount indicators, respectively.



B If this machine could not acquire the information, the remaining amount is not displayed.

■ [Disposal Box Space]

Shows the remaining amount of space in the master disposal box with an icon.

■ [Drum Information]

Shows the size and color of the print drum (cylinder) that is set in this machine. When [Ink Saving] (A 52) is used for making the master on the print drum (cylinder), [Ink Saving] is displayed.

■ Date and Time

Shows the internal clock of this machine. You can adjust the clock in [Clock/Calendar] (A 114) under [Admin].

■ [My Counter]

Shows [My Counter] in the [I Info] screen if the authentication function (A 122) is set to on. Touching [My Counter] displays the [My Counter] screen.

You can check the counter of the currently authenticated users in the [My Counter] screen. (A 96 “Calculating the Total Number of Copies [ID Counter Report]”)

My Counter		Close
U-1 [G-1]		
Limit T/C	10,000	
Present T/C	6,511	
Limit M/C	10,000	
Present M/C	250	

Setting the Master Roll

If a master roll is depleted, a message is displayed and this machine stops. Set a new master roll in place.



B It is recommended to use products specified by RISO when replacing the master roll.

B Keep the power on while replacing the master roll.



B You can watch the procedure in the movie.



<https://www.youtube.com/watch?v=70PuCv4BxQo>

C The code may not be able to be read depending on the smartphone or tablet model. In such cases, go to the above URL.

C There are expenses such as communication costs when watching the movie.

C The movie may be cancelled without notice.

1 Open the front door.

2 Check that the [Master Making Unit Release Button] lamp is lit.

If the lamp is off, press [Master Making Unit Release Button] to light it up.

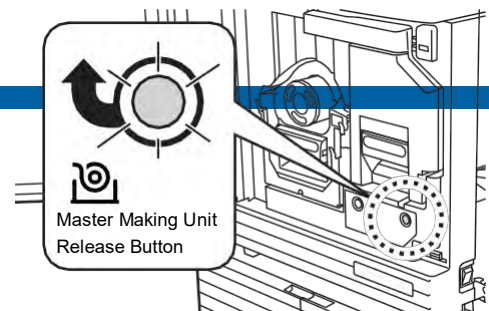

B When the print drum (cylinder) is pulled out, you cannot pull out the master making unit. Return the print drum (cylinder) to its original position, and then press [Master Making Unit Release Button].

3 Pull out the master making unit.

- 1 Grasp the master making unit handle and pull it to the front.

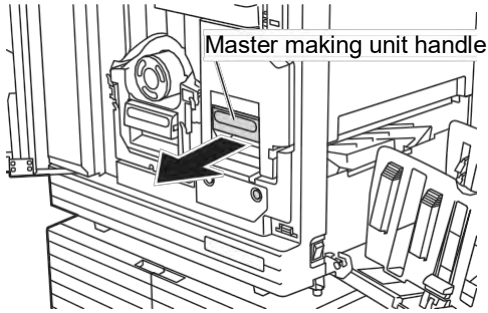

- 2 Pull out the master making unit slowly as far as it will go.

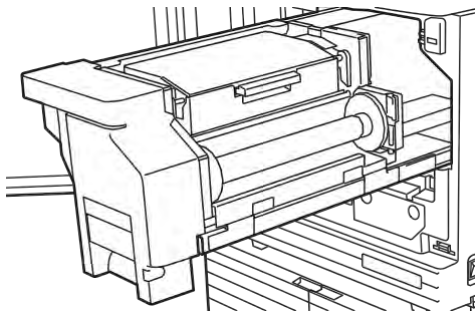

4 Open the master making unit cover.

While grasping the handle, open the master making unit cover.

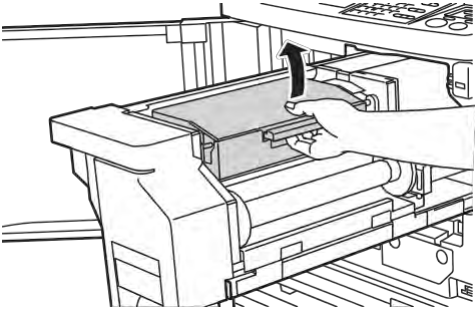

5 Open the master roll holder.

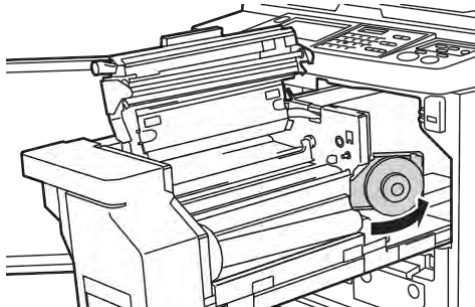

6 Remove the depleted master core.

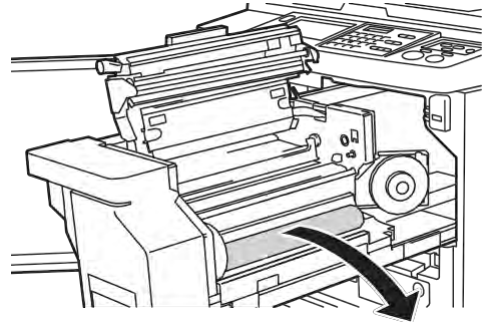

B Dispose of the depleted master core according to the disposal regulations of your local community.

(A 145 “Collecting and Disposing of Depleted Consumables”)

B Clean the thermal print head.

(A 148 “Maintenance”)

7 Set a new master roll.

Remove the package (transparent film) of the master roll. Set the master roll so that the [I] symbol is located on the left.



B Take care not to scratch the [I] section. If the [I] section is bent or cut at a perforation, the master roll will become unusable.

B Do not remove the tape yet.

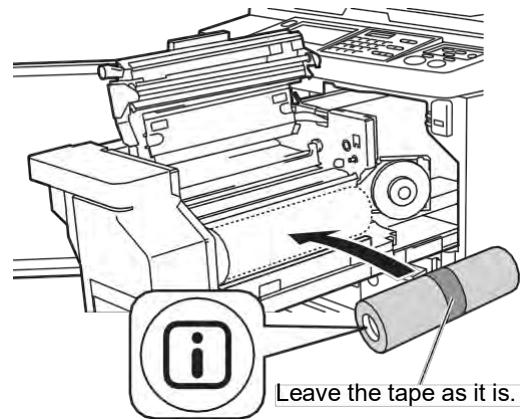

8 Close the master roll holder.

- 1 Close the master roll holder.

2 Remove the tape.

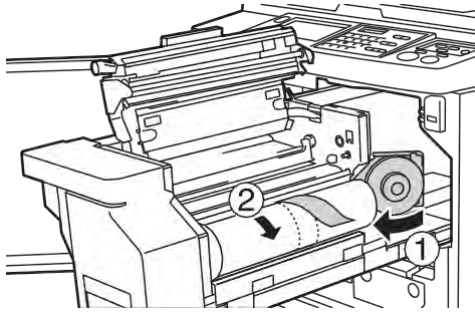

9 Insert the leading edge of the master roll under the master guide flap.

- 1 Insert the leading edge of the master roll under the master guide flap and advance it as far as it will go.
- 2 If the master roll is loose, turn the flange on the right toward the rear and rewind it.

Master guide flap

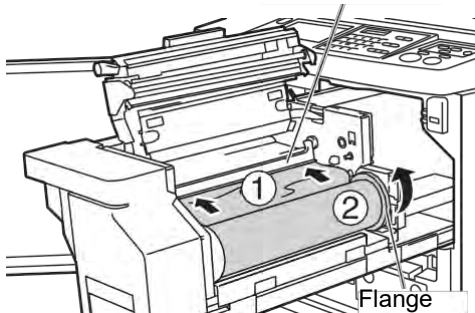

■ If you cannot insert the master roll

Insert the master roll using the following steps.

- 1 Turn the dial at the edge of the master guide flap toward the rear and raise the master guide flap.
- 2 Align the leading edge of the master roll to the line indicated by the arrow.
- 3 Return the master guide flap to its original position.

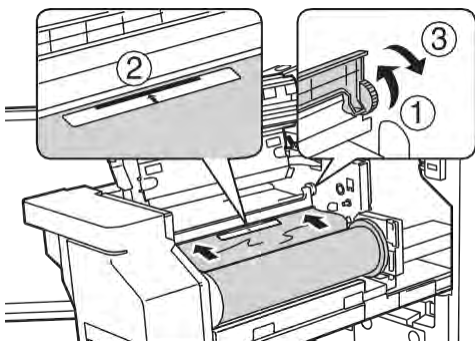

10 Close the master making unit cover.

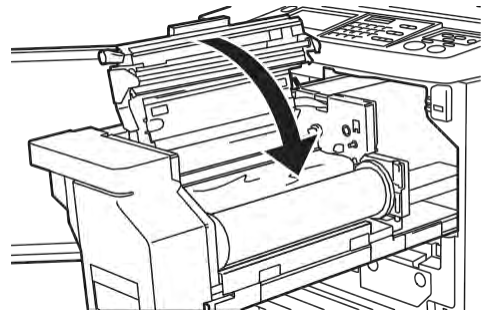

- ⚠ **B** When closing the master making unit cover, press the cover itself with your hands from above without holding the lever. Make sure to close it so that it does not open when you release your hands.

11 Return the master making unit to its original position.

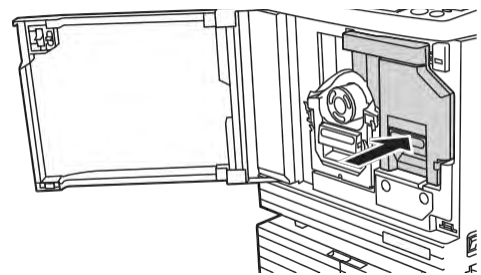

12 Close the front door.

Replacing the Ink Cartridge

When the ink is depleted, a message is displayed and this machine stops. Replace the ink cartridge with a new one.



You can watch the procedure in the movie.



<https://www.youtube.com/watch?v=9WBLunKij04>

The code may not be able to be read depending on the smartphone or tablet model. In such cases, go to the above URL.

There are expenses such as communication costs when watching the movie.

The movie may be cancelled without notice.



Caution

Ink may be left on the area around the print drum (cylinder). Take care not to smudge your hands or clothes with the ink.

Wash immediately with soap if you get ink on your hands, etc.



It is recommended to use products specified by RISO when replacing the ink cartridge.

Keep the power on while replacing the ink cartridge.

Replace with an ink cartridge of the same ink color. If you want to change the ink color, replace the entire print drum (cylinder). (A 143 “Replacing the Print Drum (Cylinder)”)

1 Open the front door.

2 Pull out the depleted ink cartridge.

- 1 Turn the ink cartridge counterclockwise.
- 2 Pull out the ink cartridge to the front.

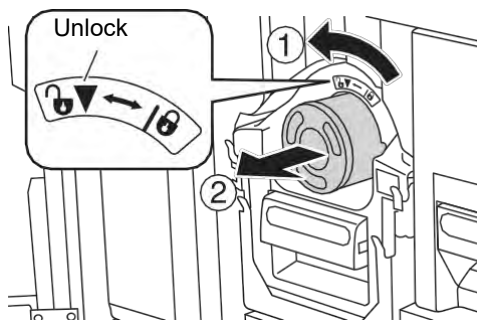

Dispose of the depleted ink cartridge according to the disposal regulations of your local community.

(A 145 “Collecting and Disposing of Depleted Consumables”)

3 Remove the cap of the new ink cartridge.

Turn the cap of the ink cartridge to remove it.

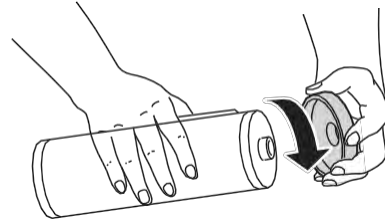

Do not touch or knock the edge of the ink cartridge.

Do not peel off or scratch the label that is attached to the edge of the ink cartridge.

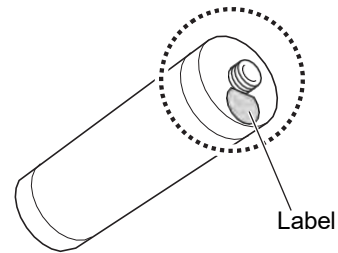

4 Set the new ink cartridge in place.

Align the arrow on the ink cartridge to the [Y] mark on the print drum (cylinder), and then insert the ink cartridge as far as it will go. (Locate the protrusion of the ink cartridge to the right.)

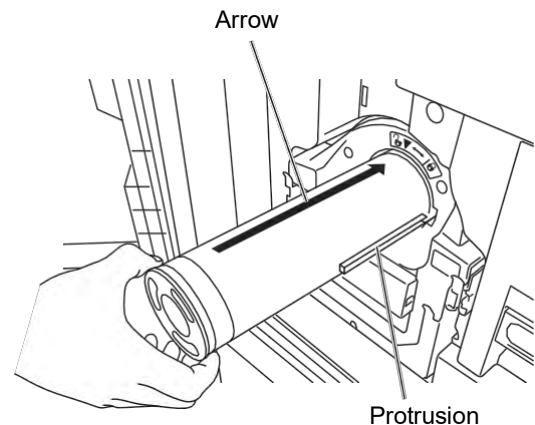

- !** Check the orientation of the ink cartridge carefully when setting it in place. Forcibly pressing it may result in damage.

5 Lock the ink cartridge.

Turn the ink cartridge clockwise to lock it.

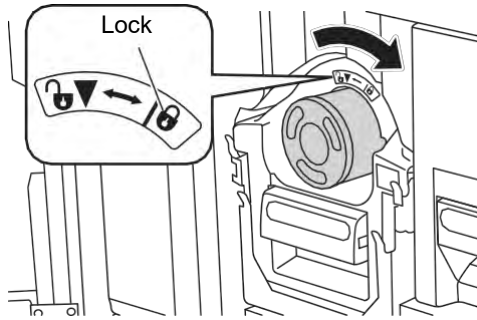

6 Close the front door.

Emptying the Master Disposal Box

Used masters are sent to the master disposal box. When the master disposal box becomes full, a message is displayed and this machine stops. Dispose of the used masters.



B Keep the power on while emptying the master disposal box.



B You can watch the procedure in the movie.



https://www.youtube.com/watch?v=eNyXo__RbmY

C The code may not be able to be read depending on the smartphone or tablet model. In such cases, go to the above URL.

C There are expenses such as communication costs when watching the movie.

C The movie may be cancelled without notice.



Caution

Wash immediately with soap if you get ink on your hands, etc.



B When [Protect] (A 128) is set to on, you can remove the master disposal box only when the following message is displayed.

C [Master Disposal Box is Full]

C [Master Jammed in Disposal Unit]

1 Unlock the master disposal box.

If the master disposal box is locked, slide the lock lever to the right to unlock it. (This operation is not necessary if the lock handle is not attached.)

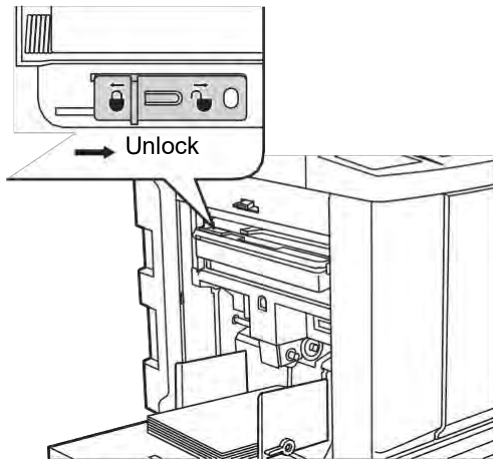

B If a padlock is attached to the master disposal box, contact your administrator and unlock it.

2 Remove the master disposal box.

Pull out the master disposal box horizontally while grasping the master disposal box handle.

Master disposal box handle

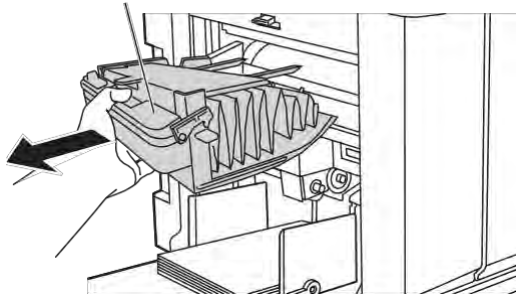

3 Dispose of the used masters.

Tilt the master disposal box to the front above a garbage box. Grasping the push-out handle drops the used masters.

Push-out lever

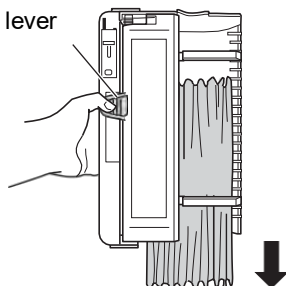

4 Set the master disposal box in place.

Insert the master disposal box as far as it will go.

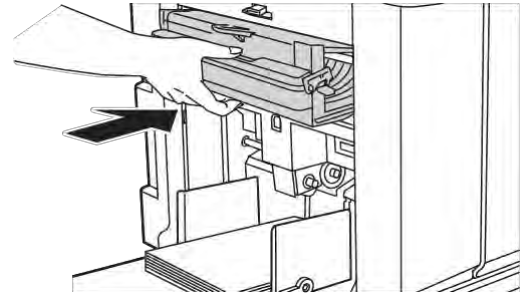

B Dispose of the used masters according to the disposal regulations of your local community. (A 145 “Collecting and Disposing of Depleted Consumables”)

B Normally, you can use this machine while the master disposal box is unlocked. Slide the lock lever to the left to lock the master disposal box as necessary. You can also attach the padlock (A 128).

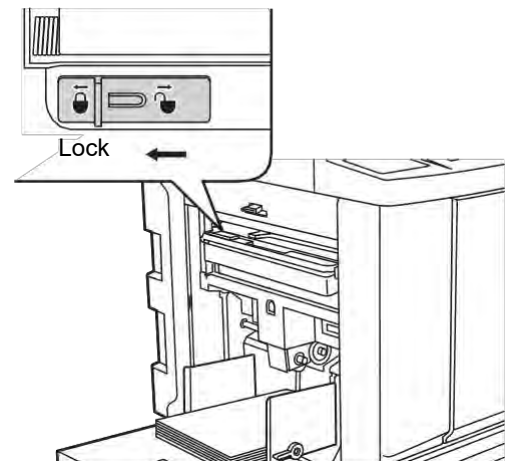

Replacing the Print Drum (Cylinder)

If you want to print in a different color, replace the print drum (cylinder). When you want to remove jammed paper inside this machine, you can also remove the print drum (cylinder).

Caution

- Ink may be left on the area around the print drum (cylinder) or the inside of this machine after the print drum (cylinder) unit has been removed. Take care not to smudge your hands or clothes with the ink. Wash immediately with soap if you get ink on your hands, etc.
- When you put your hands inside the main unit, take care not to touch any protrusions or edges of the metal plate. It may result in injury.
- Do not stand the print drum (cylinder) vertically. Doing so may stain the floor, etc.

-  **Use the dedicated print drum (cylinder) for this machine.**
(A 172 “Optional Accessories”)
- **Keep the power on while removing or replacing the print drum (cylinder).**
- **Store the replaced print drum (cylinder) horizontally in the print drum (cylinder) case.**

Removing the print drum (cylinder)

- 1 Open the front door.**
- 2 Check that the [Print Drum (Cylinder) Release Button] lamp is lit.**

If the lamp is off, press [Print Drum (Cylinder) Release Button] to light it up.

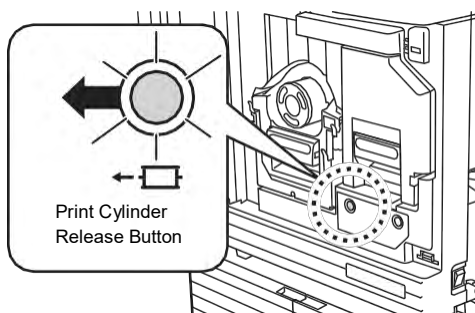

B When the master making unit is pulled out, you cannot pull out the print drum (cylinder). Return the master making unit to its original position, and then press [Print Drum (Cylinder) Release Button].

- 3 Pull out the print drum (cylinder).**
Pull out the print drum (cylinder) slowly as far as it will go while grasping the print drum (cylinder) handle.

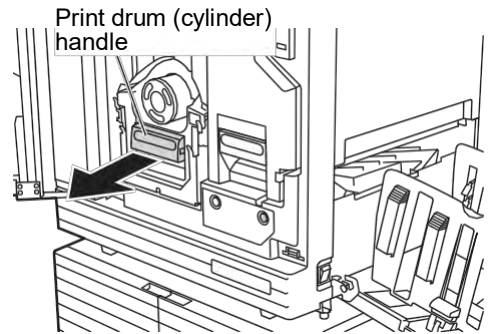

- 4 Remove the print drum (cylinder).**
Use both hands to lift the print drum (cylinder) straight up and remove it from the rail. Firmly grasp the blue handle section.

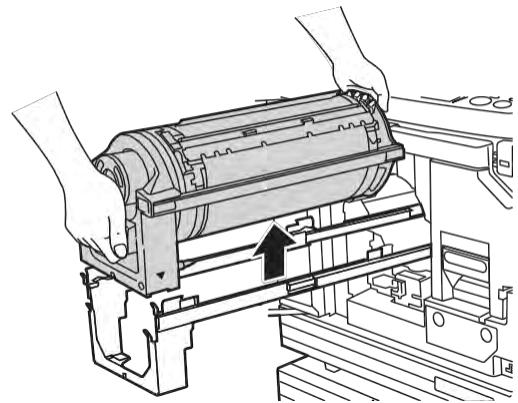

B Do not touch the connector on the print drum (cylinder). Neglecting this may result in a malfunction of the print drum (cylinder) because of static electricity or other factors.

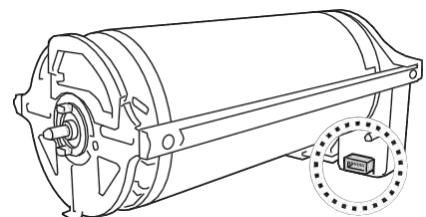

Installing the print drum (cylinder)

1 Place the print drum (cylinder) on the rail.

Align the [Y]mark on the print drum (cylinder) with the [Y]mark on the rail. Place the print drum (cylinder) on the rail horizontally.

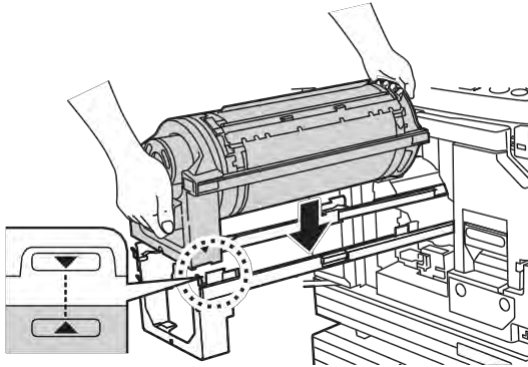

! If the print drum (cylinder) was manually rotated, be sure to return it so that the [Y] and [] marks align after the procedure is complete.

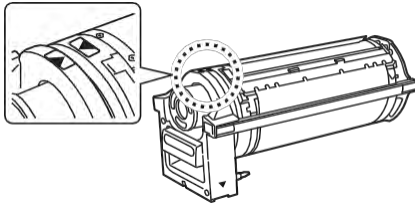

2 Return the print drum (cylinder) to this machine.

Push in the print drum (cylinder) slowly as far as it will go.

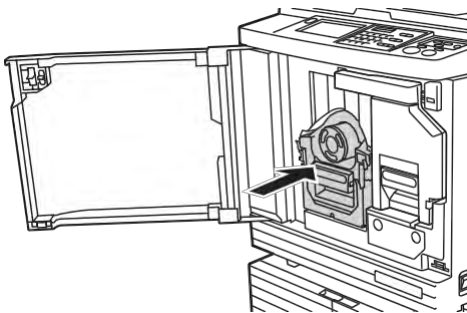

! When pushing in the print drum (cylinder), do not grasp the print drum (cylinder) handle.

3 Close the front door.

■ When you have changed the type of print drum (cylinder)

When you change the type of print drum (cylinder) between Ledger/A3 and A4/Letter, a confirmation screen is displayed. Confirm the type of the print drum (cylinder) using the following steps.



- 1 Touch the type of the print drum (cylinder) that you have set.
- 2 Touch [OK].

Collecting and Disposing of Depleted Consumables

Ink cartridge

- Dispose of the depleted ink cartridges according to the disposal regulations of your local community. If required, separate the specific components using the following procedures as a reference.

Parts	Materials
Ink cartridge and cap	Plastic (polypropylene or polyethylene)
Label	Plastic (metal included)
Ink	Plant oil, petroleum hydrocarbons, water, pigments

- Remove the label at the edge of the ink cartridge by peeling it off from the section indicated with the arrow in the illustration below, and then dispose of it separately.

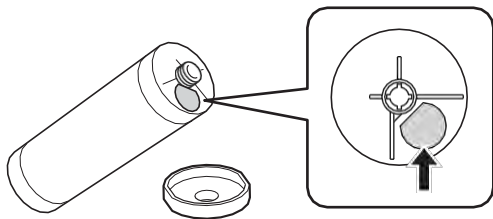

Caution

Ink may be left on the area around the edge of the ink cartridge. Take care not to smudge your hands or clothes with the ink. Wash immediately with soap if you get ink on your hands, etc.

Master core

- Dispose of the depleted master core according to the disposal regulations of your local community. If required, separate the specific components using the following procedures as a reference.

Parts	Materials
Core	Paper
Master roll	Plastic, Japanese paper
Cutout section marked with []	Plastic (metal included), paper

- A label that includes a metallic component is attached to the rear side of the section that is stamped with the [] mark. Tear along the perforation and dispose of it separately.

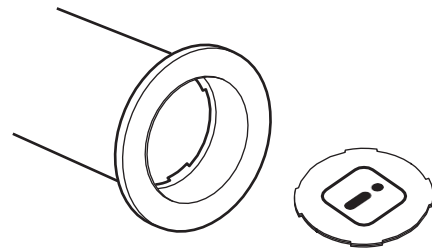

Used master

- Dispose of the used masters according to the disposal regulations of your local community. If required, separate the specific components using the following procedures as a reference.

Parts	Materials
Master roll	Plastic, Japanese paper (ink remains on the master roll)



B The master is made of carbon and hydrogen compounds. If it is fully combusted, it will turn into water and carbon dioxide.



Chapter **10**
Maintenance

Maintenance

The finish of prints may be stained or blurred if the thermal print head of the master making unit, parts such as the scanner glass and white sheet of the optional auto document feeder, or other parts are contaminated with dust, dirt, white-out, etc. We recommend that you perform maintenance periodically.



Caution

Do not perform any procedures (adjustment, repair, etc.) that are not described in this guide. When you want to adjust or repair, consult your dealer or authorized service representative.

Thermal print head

The thermal print head is a component that produces heat during master making and forms minute holes on the master. Clean it whenever the master roll is replaced.

Open the master making unit cover, and then gently wipe the thermal print head in the back of the unit several times with a soft cloth, etc.



Caution



Hot surface

Do not directly touch the thermal print head with your fingers. The thermal print head may be heated and cause burns.



B The thermal print head is extremely delicate. Avoid creating excessive impacts or scratches with a hard object.

B The thermal print head is susceptible to static electricity. Be sure to remove the static electricity charge that is accumulated in your body before cleaning.

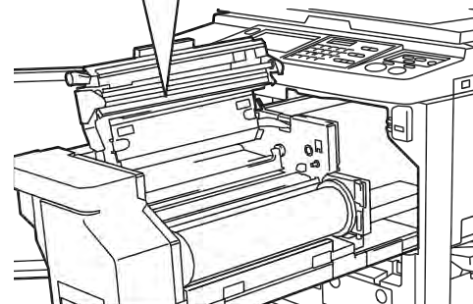
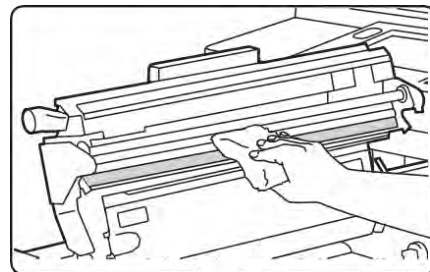

Exterior

Use a soft cloth to gently wipe the entire exterior periodically in order to protect the machine exterior from dust.



- B Plastic is used for the machine exterior. Do not use alcohol or solvent for cleaning.**

Normally, gently wipe off dirt on the touch panel with a dry cloth. If ink adheres to the touch panel, dampen a cloth with a small amount of cleaner and gently wipe it off.



- B Do not coat or spray the cleaner solution directly onto the touch panel. Doing so may result in malfunctions.**

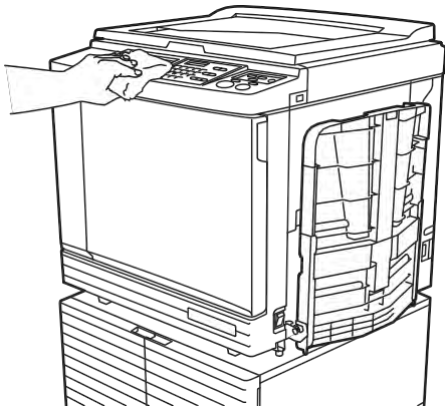

Glass platen and platen cover pad

If the glass platen or platen cover pad is stained, gently wipe it off several times with a soft cloth or tissue paper.



- B The glass platen is extremely delicate. Avoid creating excessive impacts or scratches with a hard object.**

Glass platen

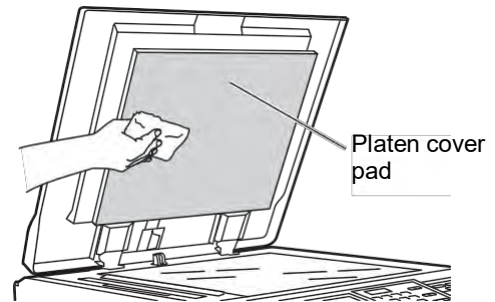
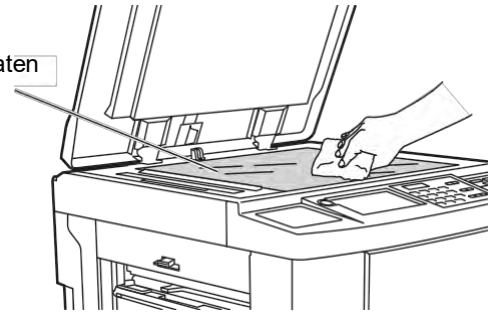

Platen cover pad

Optional Auto Document Feeder

Gently wipe any stains off the scanner glass and white sheet with a soft cloth or tissue paper.

- !** **B The scanner glass is extremely delicate. Avoid creating excessive impacts or scratches with a hard object.**

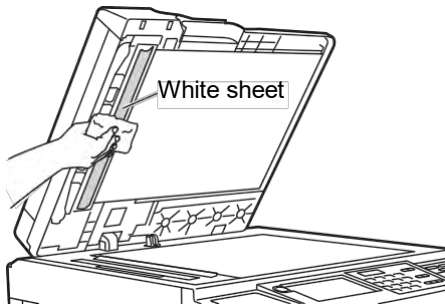
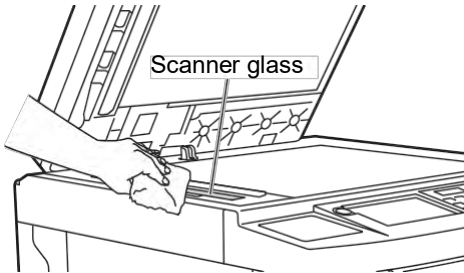

Pressure roller

The pressure roller is a component that presses a paper against the print drum (cylinder) unit. If the pressure roller is stained, smudged strips may appear on the back of papers.

Gently wipe the pressure roller several times with a soft cloth or tissue paper.

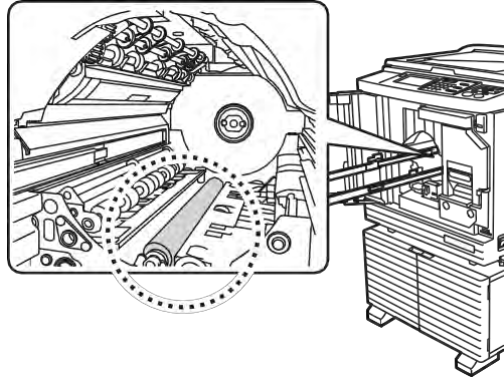

! Caution

- Be sure to turn off the power to this machine when cleaning the pressure roller.
- Ink may be left on the inside of this machine after the print drum (cylinder) unit has been removed. Take care not to smudge your hands or clothes with the ink. Wash immediately with soap if you get ink on your hands, etc.
- When you put your hands inside the main unit, take care not to touch the paper separation hook or master removal hooks. The sharp tips of these hooks can hurt your hands.



Master removal hooks

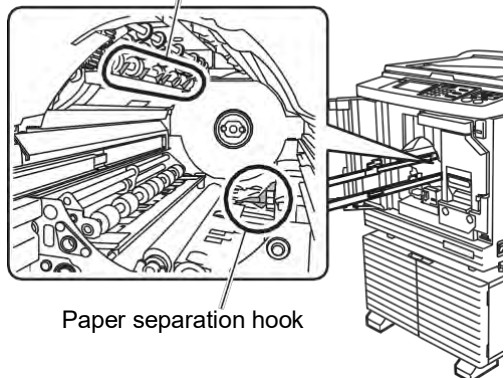

Paper separation hook



Chapter 11

Troubleshooting

When a Message Is Displayed

This section describes the troubleshooting procedure when an error message is displayed.



Caution

When you put your hands inside the main unit, take care not to touch any protrusions or edges of the metal plate. It may result in injury.

How to view the message

A troubleshooting procedure is displayed in accordance with situation.

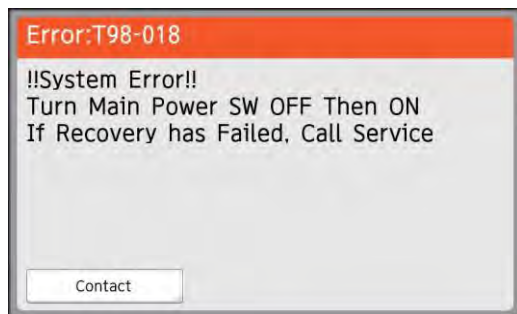

Code:

The code for the symptom are displayed.

Message:

The description of what is happening and the troubleshooting procedure are displayed.

An explanatory drawing may also be displayed.

Code*	Type	Description
T00-0000	Service call error	This type of error is displayed when an error that requires inspection and repair by an authorized service representative has occurred. Report the code of the error to your dealer or authorized service representative.
A00-0000	Master jam error	This type of error is displayed when a master is jammed.
B00-0000	Optional accessory error	This type of error is displayed when an error has occurred in any of the optional accessories that are currently connected.
C00-0000	Consumables error	This type of error is displayed when any consumables, such as ink and master rolls, are depleted.
D00-0000	Installation check error	This type of error is displayed when any of the sections is installed incorrectly.
E00-0000	Maintenance call error	This is displayed when battery replacement or periodic inspection by an authorized service representative is necessary. Report the code of the error to your dealer or authorized service representative.
F00-0000 G00-0000	Warning	This is displayed when the setting on the control panel does not conform to the condition of this machine.
J00	Paper jam error	This type of error is displayed when an original or paper is jammed.

* For "0" of each code in the above list, the specific number is displayed.

Example of message



The following provides a typical example of a message.

For anything that are not included in the following list, take an action according to the displayed message.

■ T00-0000: Service call error

Code	Message	Action
T25	!!Battery Replacement!! Call Service	Consult your dealer or authorized service representative and replace the battery. Press the [RESET] key to clear the error message.

■ A00-0000: Master jam error

Code	Message	Action
A01	Master Mis-Feed Pull Out Master Making Unit and Rewind Master Roll, then Reset Master in Place	Pull out the master making unit, and then set a master roll in place correctly. (A 137 "Setting the Master Roll")  If the rewound master roll is wrinkled or cut in a zig-zag manner, cut off the end of the master roll by using a cutter, etc., and then set it in place.
A02	Master Loading Error Pull Out Print Drum and Discard Master	1 Pull out the print drum (cylinder), and then remove the master on the print drum (cylinder). (A 143 "Replacing the Print Drum (Cylinder)") 2 Set the print drum (cylinder) in place again.
A04	Master Disposal Error Pull Out Print Drum and Discard Master	3 Press the [START] key.
A05	Master Jammed in Disposal Unit Pull Out Master Disposal Box and Remove Jammed Master	Take out the disposal box, and then remove the jammed master. (A 141 "Emptying the Master Disposal Box") If the error display does not disappear, consult your dealer or authorized service representative.
A06	Set SW on Standard Feed Tray is Activated Reset paper on Standard Feed Tray	Check for any obstacles under the paper feed tray or on the paper. If there are any obstacles, remove them.
A16	Master Remains on Print Drum Pull Out Print Drum and Remove Master	1 Pull out the print drum (cylinder), and then remove the master on the print drum (cylinder). (A 143 "Replacing the Print Drum (Cylinder)") 2 Set the print drum (cylinder) in place again. 3 Press the [START] key.
A17	System Error in Master Making Unit Take Out Master and then Close Master Making- Unit Cover	The cutter that cuts the master roll did not function properly. 1 Pull out the master making unit, and then remove the master roll. (A 137 "Setting the Master Roll") 2 Close the master making unit cover to clear the error. 3 Open the master making unit cover again, and then set the master roll in place.
A34	Master Not Set in Place Insert Lead Edge of Master into Master Entrance and Close Master Making Unit	Set the master roll in place correctly. (A 137 "Setting the Master Roll")  If the rewound master roll is wrinkled or cut in a zig-zag manner, cut off the end of the master roll by using a cutter, etc., and then set it in place.



■ B00-0000: Optional accessory error

Code	Message	Action
B29	Can not identify (USB hub)	A USB hub is set in the USB port of this machine. Set a USB flash drive that is usable for this machine. (A 13 “Method to use a USB flash drive”)
B30 B38 B39	Can not identify	Set a USB flash drive that is usable for this machine. (A 13 “Method to use a USB flash drive”)
B33	No IP Address Assigned to This Printer Contact Your Network Administrator	Set the IP address of this machine. (A 114 “[Network Settings (IPv4)]”) (A 114 “[Network Settings (IPv6)]”)

■ C00-0000: Consumables error

Code	Message	Action
C11	Expired Ink Replace Ink Cartridge	Replace the ink cartridge with a new one. (A 140 “Replacing the Ink Cartridge”)
C12	Expired Master Replace Master Roll	Replace the master roll with a new one. (A 137 “Setting the Master Roll”)
C13	Expired Ink & Master Replace them	Replace the ink cartridge and the master roll with new ones. (A 140 “Replacing the Ink Cartridge”) (A 137 “Setting the Master Roll”)

■ D00-0000: Installation error

Code	Message	Action
D02	Wrong-Type Print Drum Installed Replace with Correct Type	Set an appropriate print drum (cylinder) in place. (A 143 “Replacing the Print Drum (Cylinder)”)  Use the dedicated print drum (cylinder) for this machine. If other print drums (cylinders) are used, it may result in malfunctions or problems.
D04	Wrong-type Ink Cartridge Installed or Cannot Read Ink Info Replace Ink Cartridge or Contact dealer/Riso Office	Check that the type and color of the ink cartridge are appropriate. Set an appropriate ink cartridge in place.  Use the ink cartridge that is recommended by RISO. If other ink cartridges are used, it may result in malfunctions or problems.
		Check if the label at the edge of the ink cartridge has been peeled off or stained. The label at the edge of the ink cartridge contains the necessary information for printing. Set an ink cartridge in place on which an unstained label is properly attached. (A 140 “Replacing the Ink Cartridge”)

Code	Message	Action
D17	Wrong-type Master Installed or Cannot Read Master Info Replace Master Roll or Contact dealer/Riso Office	Check that the type of master roll is appropriate. Set an appropriate master roll in place. ! Use the master roll that is recommended by RISO. If other master rolls are used, it may result in malfunctions or problems.
		Check if the [] section of the master core is bent or cut. The [] section of the master core contains the necessary information for printing. Set a master roll in place that contains a [] section that is not bent or cut. (A 137 "Setting the Master Roll")
D45	Install Ink Cartridge	The ink cartridge may have not been installed properly. Remove the ink cartridge and set it again. (A 140 "Replacing the Ink Cartridge")

■ E00-0000: Maintenance call error

Code	Message	Action
E01	!!Low Battery!! Call Service	The internal battery of this machine is almost depleted. Consult your dealer or authorized service representative for battery replacement.
E02	!!Maintenance!! Call Service	Consult your dealer or authorized service representative for periodic inspection.

■ F00-0000/G00-0000: Warning



[Cancel] or [Continue] may be displayed on the screen.
To interrupt the operation, touch [Cancel]. Touch [Continue] to resume the operation.

Code	Message	Action
F01	No Master on Print Drum Make a New Master	After touching [Close], perform master making. ! If you leave the print drum (cylinder) with no master attached, the print drum (cylinder) will dry, and this situation may result in malfunctions. Be sure to perform master making or [Confidential] (A 93) and load a master on to the print drum (cylinder).
F02	Page Format is Larger than Paper Size !! Possible Ink Smudges on Prints !!	The paper that is currently set is smaller than the size of the master that has been made. Check the size of the paper and set an appropriate paper.
F04	Reached to the limit count Contact the administrator	The count has reached the upper limit of the preset number of masters to be created or number of printed copies. Please contact your administrator. (A 126 [User Management]-[Setting the upper limit number of copies that can be used])
F10	Page Format is Larger than Paper Size !! Possible Ink Smudges on Prints !! (Continue->PROOF Key)	The paper that is currently set is smaller than the size of the master that has been made. Check the size of the paper and set an appropriate paper. To continue outputting the proof copies, press the [PROOF] key.

Code	Message	Action
F28	The Paper Feed Setting Lever is set to "CARD". Check if the setting is consistent with paper in the Standard Feed Tray.	This screen is displayed when the paper feed setting lever is set to the position of [CARD] while [Paper Feed Adj.] (A 77) is set to [Auto]. Check the paper to be used, and then switch the position of the paper feed setting lever (A 28) as necessary.
F30	!! Possible Multiple Paper Feed !! Check Printed Copies	If double feeding (the feeding of overlapped sheets of paper) occurs, take the appropriate action by referring to the instructions on the following page. (A 169 "Papers are not smoothly fed from the paper feed tray.") If double feeding did not occur, touch [D-Check OFF], and set [D-Feed Check] (A 81).
F32	!! The Data Storage Area has Become Full !! Clear Old Storage Data	Touch [Storage], and then delete any of the unnecessary original data.
F33	The file size is too large to store on USB flash drive Change the USB flash drive or delete some files to make spaces	Touch [USB Job List], and then delete any of the unnecessary original data.
F34	!! The Number of Storage Data has Become Full !! Clear Old Storage Data in the Selected Folder	Touch [Storage], and then delete any of the unnecessary original data.
F51	INK Near expiration Use or replace soon	In order to use the ink cartridge under optimal conditions, use it within approximately 24 months after its manufacture date.
F56	MASTER Near expiration Use or replace soon	In order to use the master roll under optimal conditions, use it within approximately 24 months after its manufacture date.
F57	INK & MASTER Near expiration Use or replace soon	In order to use the ink cartridge and the master roll under optimal conditions, use them within approximately 24 months after their manufacture date.
F65	Auto Page Size Selection is Not Available for Irregular-Size Original Select Format Size to Store and then Restart	When a custom size original is currently set in place, touch [Format] (A 107), and then specify the size of the data to be saved.
		If the position of the original is shifted, set it back to the correct position.
F74	Printer Temperature is Low "High Speed" is Not Available	[High Speed] is available when the temperature in the print drum (cylinder) is 5°C (41°F) or higher. If the print drum (cylinder) is cool, increase the room temperature or print at speed [5] for a while, and wait until the print drum (cylinder) is sufficiently warm.
F85	! Scanning is Not Possible ! External Controller is not Connected or Processing Connection Check Cable Connection	Check that the optional RISO Controller IS300 is connected correctly.

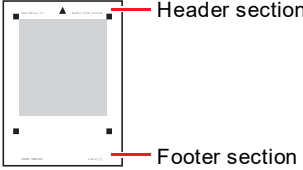
Code	Message	Action
F93	Check the Settings The Selected Reproduction Ratio will not fit the Max. Printing Area	Touch [Size] (A 53), and then change the magnification rate. You can also touch [Continue] without changing the magnification rate. However, a complete image may not be printed in this case, because the area outside “master making area” (A 16) is not included in master making.
F94 F95	-- Protect -- Discard Current Master	Touch [OK] to perform [Confidential] (A 93). (A 128 “Managing the Used Master [Protect]”)
F96	Please inform this message to your administrator Due date for ID counter report	Please contact your administrator to announce that the ID counter report day has arrived.  BUntil [Report Output] (A 96) is performed, a warning screen is displayed whenever the power turns on. If you do not want to perform [Report Output] for the current month, touch [Stop Reminder] under [ID Counter Report] (A 96).
G02	Decoding Paper Memory Print failed Check the position of the original	If the Paper Memory Original is not placed straight on the glass platen, it may not be scanned properly. Place the Paper Memory Original again. If the glass platen or platen cover pad is stained, the Paper Memory Original may not be scanned properly. Clean the glass platen and retry scanning the Paper Memory Original. (A 149 “Glass platen and platen cover pad”) If the Paper Memory Original is stained, wrinkled, or creased, or if the Paper Memory Original has writing in an undesignated area (A 65), this machine may not be able to properly scan the Paper Memory Original. We advise that the Paper Memory Original be printed again on a clean sheet of paper.
G03	The original is incorrect Set the following original	Confirm the following information printed on the paper memory original, and place the appropriate paper memory original. <ul style="list-style-type: none"> • Header section: Must match the page number/total number of pages and the conversion date and time that are displayed on the error screen. • Footer section: Must match your printer series. 
G10	!! Slip Sheet Sorting is Not Available with This Paper Size !! Replace with Paper of Proper Size	When you want to execute [Slip sheet sorting] (A 89), place paper of the following size. (Standard sizes) SF9350EII/SF5250EII A3p, B4p, A4p, or Foolscapp SF9450EII Ledgerp, Legalp, or Letterp (Custom sizes) 210 mm x 280 mm to 310 mm x 432 mm (8 1/4 inches x 11 1/32 inches to 12 7/32 inches x 17 inches) For custom size, select the desired paper size for [Paper Size] (A 55).





J00: Paper jam error

The location in which an original or paper is jammed blinks on the screen.

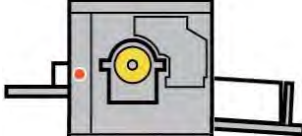
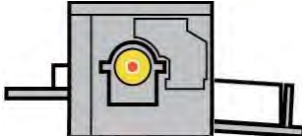

 BIn order to prevent a paper jam, use appropriate papers for printing. (A 14 "Printing papers")

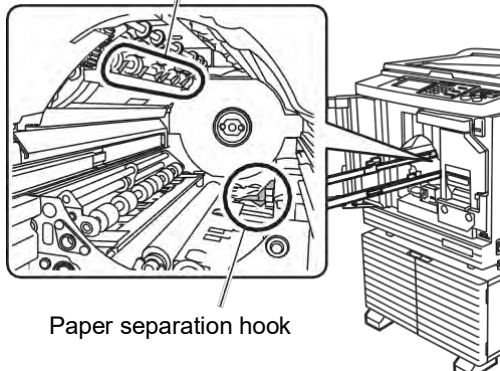
BWhen placing originals on the optional auto document feeder, use an appropriate original. (A 14 "Originals")

Error location	Action
<p>Optional auto document feeder</p> 	<p>Open the ADF cover, and then remove any jammed originals. Depending on the location of the jammed original, you can also remove it from the bottom of the auto document feeder by raising the platen cover.</p>
<p>Paper feeding side</p> 	<p>Check the paper feeding side and lower the paper feed tray, and then remove any jammed papers. If the error display does not disappear, press the [RESET] key.</p> <p>B Occasionally, switching the paper feed setting lever can prevent a paper jam. (A 28 "Setting up the paper feed tray and the paper")</p>
<p>Around the print drum (cylinder)</p> 	<p>Pull out the print drum (cylinder), and then remove any jammed papers. (A 143 "Replacing the Print Drum (Cylinder)")</p> <p> Caution</p> <ul style="list-style-type: none"> • Ink may be left on the areas near the print drum (cylinder) and the inside of the main unit after the print drum (cylinder) unit has been removed. Take care not to smudge your hands or clothes. Wash immediately with soap if you get ink on your hands, etc. • When you put your hands inside the main unit, take care not to touch the paper separation hook or master removal hooks. The sharp tips of these hooks can hurt your hands. <p style="text-align: center;">Master removal hooks</p>  <p style="text-align: center;">Paper separation hook</p> 

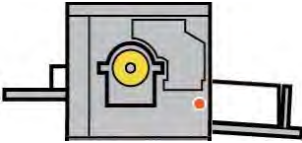
Error location	Action
Paper receiving side 	Check the paper receiving side and remove any jammed papers.

When the [Consumables Information Input Wizard] screen is displayed

In order to maintain the optimum printing conditions, this machine obtains the information from the consumables. If the information cannot be obtained, the [Consumables Information Input Wizard] screen is displayed. Enter an appropriate value.



B We assume no responsibility or liability for cases in which you use any consumables other than the consumables recommended by RISO. We are also unable to provide appropriate values for setting. If appropriate values for setting are unknown, we recommend that you adjust by changing values from [1] and on, while checking the print results at the same time.

B If the following operations are performed, the entered values will be erased. In this case, it is necessary to re-enter those values.

CThe power switch is turned off and then on again.



CThe [WAKE-UP] key is pressed while this machine is in sleep mode.

■ [Ink Information Input]

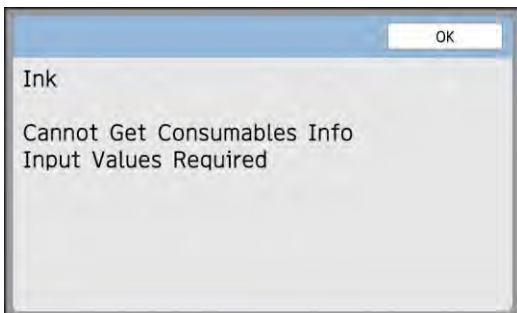
1 Touch [OK] on the following screen.

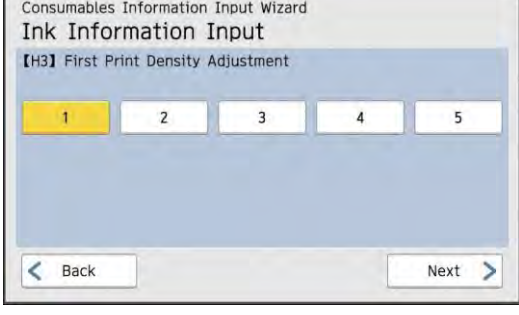
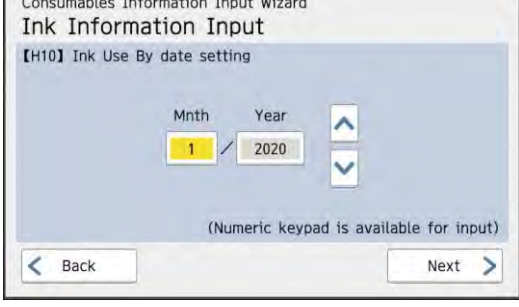

2 Set the items according to the following table.

Screen display	Description of setting	Value
	<p>[H1] Ink Color Setting Select the same color as the color of the print drum (cylinder) that is currently used.</p>	1:Black 2:Color
	<p>[H2] Print Density Fine Adjustment Select the value to obtain the appropriate print density according to the ink.</p>	1 (light) to 5 (dark)
	<p>[H3] First Print Density Adjustment Select the value to obtain the appropriate print density for the first print according to the ink.</p>	1 (light) to 5 (dark)
	<p>[H10] Ink Use By date setting Set the month and year to display the [F51] warning (A 156).</p>	Mnth: 01 to 12 Year: 2001 to 2099

3 When setting is complete, a confirmation screen is displayed. Check the value, and then press the [START] key. The basic screen is displayed.

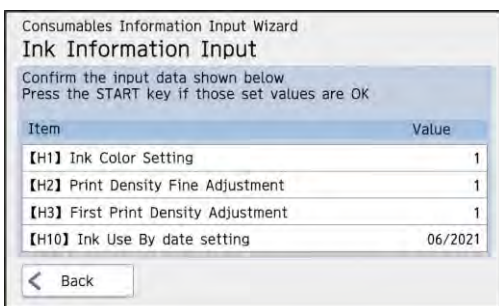

Item	Value
[H1] Ink Color Setting	1
[H2] Print Density Fine Adjustment	1
[H3] First Print Density Adjustment	1
[H10] Ink Use By date setting	06/2021

■ [Master Information Input]

1 Touch [OK] on the following screen.

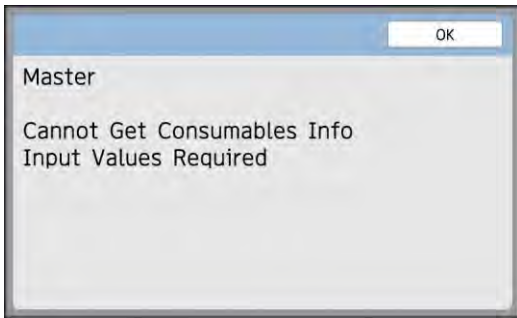

2 Set the items according to the following table.

Screen display	Description	Value
	<p>[H4] Master Density Select the value to obtain the appropriate master making density according to the master.</p>	1 (light) to 10 (dark)
	<p>[H5] Print Density Fine Adjustment Select the value to obtain the appropriate print density according to the master.</p>	1 (light) to 5 (dark)
	<p>[H6] First Print Density Adjustment Select the value to obtain the appropriate print density for the first print according to the master.</p>	1 (light) to 5 (dark)
	<p>[H11] Master Use By date setting Set the month and year to display the [F56] warning (A 156).</p>	Mnth: 01 to 12 Year: 2001 to 2099

- 3 When setting is complete, a confirmation screen is displayed.
Check the value, and then press the [START] key. The basic screen is displayed.

Consumables Information Input Wizard
Master Information Input

Confirm the input data shown below
Press the START key if those set values are OK

Item	Value
【H4】 Master Density	1
【H5】 Print Density Fine Adjustment	1
【H6】 First Print Density Adjustment	1
【H11】 Master Use By date setting	06/2021

< Back

Troubleshooting

Check the following table and take appropriate measures before consulting your dealer or authorized service representative.



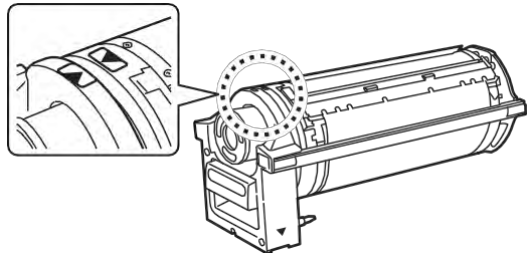

Caution

Do not perform any procedures (adjustment, repair, etc.) that are not described in this guide. When you want to adjust or repair, consult your dealer or authorized service representative.

Problem	Point to check	Action
Nothing is displayed on the touch panel even though the power is turned on.	Check if this machine is in sleep mode.	While the [WAKE-UP] key on the control panel is lit, this machine is in sleep mode. Press the [WAKE-UP] key to enable operations of this machine.
This machine does not start up when the power is turned on.	Check if the power is connected.	<ul style="list-style-type: none"> • Check the power cord for proper connection to both this machine and the electrical outlet. • Check if the commercial power breaker has tripped.
The paper feed tray cannot be closed.	Check if the feed-tray paper guides are fully widened.	Turn on the power and lower the paper feed tray to the bottom. Then, raise the lock handles for the feed-tray paper guides, widen the feed-tray paper guides up to the limit, and close the paper feed tray. (A 28 “Setting up the paper feed tray and the paper”)
	Check if the power was turned off before the paper feed tray was lowered to the bottom.	
The print drum (cylinder) cannot be placed into position.	Check if the print drum (cylinder) is rotated to the correct stop position.	<p>If the print drum (cylinder) was manually rotated, be sure to return it so that the [V] and [M] marks align after the procedure is complete.</p> 
	Check if the print drum (cylinder) is set correctly onto the rail.	Set the print drum (cylinder) correctly on the rail. (A 143 “Replacing the Print Drum (Cylinder)”)
An error message does not disappear even though an ink cartridge is set in place.	Check if the ink cartridge is set in place correctly.	After inserting the ink cartridge, turn it clockwise to lock it. (A 140 “Replacing the Ink Cartridge”)
	Check if the label at the edge of the ink cartridge is scratched or peeled off.	You cannot use an ink cartridge if its label is scratched or peeled off. Set a new ink cartridge in place. (A 140 “Replacing the Ink Cartridge”)

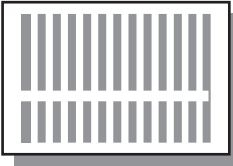
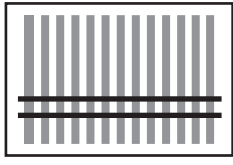
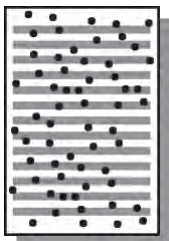
Problem	Point to check	Action
An error message does not disappear even though a master roll is set in place.	Check if the master roll is set in place correctly.	Set the master roll so that the side of the master core with the [■] mark is located on the left. (A 137 "Setting the Master Roll")
	Check if the [■] section inside the master core is bent or cut.	You cannot use the master roll if its [■] section is bent or cut. Set a new master roll in place. (A 137 "Setting the Master Roll")
The master disposal box cannot be removed.	Check if [Protect] is set to [ON].	When [Protect] under [Admin.] is set to [ON], you cannot remove the master disposal box. However, you can remove the master disposal box if a master is jammed in the master disposal section or the master disposal box becomes full. (A 128 "Managing the Used Master [Protect]")
	Check if the lock lever of the master disposal box is locked.	Slide the lock lever to the right to unlock it. If the master disposal box is locked, contact your administrator and unlock it. (A 141 "Emptying the Master Disposal Box")
The master disposal box cannot be set in place.	Check if the lock lever of the master disposal box is locked.	Slide the lock lever (A 142) of the master disposal box to the right to unlock it. Then, set the master disposal box in place.
There is no image on copies.	Check if the original is placed so that it faces up.	Place the original so that it faces down. (A 31 "Placement of Originals")
Closing the platen cover without setting an original automatically switches printing mode to master making mode.	Check if you forcefully closed the platen cover.	If an original is set and detected when the platen cover is closed in printing mode, this machine automatically switches to master making mode. However, forcefully closing the platen cover may cause this machine to incorrectly detect that an original is set even when there is no original. Close the platen cover gently.
A portion of the image is missing on printed papers.	Check if the glass platen is stained.	Wipe the glass platen with a soft cloth, etc. (A 148 "Maintenance")
	Check if any foreign objects are adhered to the master.	Pull out the print drum (cylinder) and check if any foreign object adheres to the master. If there is a foreign object, remove it. If a foreign object exists between the master and the print drum (cylinder), remove the master, and eliminate the foreign object. Then, set the print drum (cylinder) in place and perform the master making process again.
	Check if the paper size that was placed on the paper feed tray for master making is smaller than the size of the original.	The size of the master to be made is determined according to the size of the paper that is placed on the paper feed tray. Set the same size of paper on the paper feed tray as the original, and then perform the master making process.
	Does the size of the image to be printed exceed the maximum printing range of this machine?	The maximum printing area varies depending on the model. (A 16 "Maximum Printing Area") If the original is larger than the maximum printing area, reduce its size to make a master. (A 53 "Enlarging or Reducing the Size of the Original [Size]")

Problem	Point to check	Action
Blank lines are found on printed papers. 	Check if the thermal print head of the master making unit or the scanner glass of the optional auto document feeder is stained.	Wipe the thermal print head or scanner glass with a soft cloth, etc. (A 148 "Maintenance")
Lines are found on printed papers. 	Check if the scanner glass of the optional auto document feeder is stained.	Wipe the scanner glass with a soft cloth, etc. (A 148 "Maintenance")
The overall background of the printed papers is stained. 	Check if colored paper, such as newspaper, is used as the original.	Lighten the contrast in [Contrast] (A 50) and perform master making again.
	Check if the glass platen is stained.	Wipe the glass platen with a soft cloth, etc. (A 148 "Maintenance")
The edges of printed papers are smudged with ink.	Check if the size of the paper that was placed on the paper feed tray for master making is larger than the size of the original.	Set the same size of paper on the paper feed tray as the original, and then perform the master making process. The size of the master to be made is determined according to the size of the paper (the width of the feed-tray paper guides and the length of the paper) that is placed on the paper feed tray. If the size of the paper placed on the paper feed tray for master making is larger than the size of the original, the outside of the original is also included in master making. For this reason, if the platen cover is not securely closed, the edges of the original may be processed as shadows.
	Check if the feed-tray paper guides are fitted to the width of the paper during master making.	
	Check if [Max. Scan] is set to on.	If [Max. Scan] (A 56) is set to on, a master is made in the maximum printing area of the print drum (cylinder), regardless of the size of the original or paper. For this reason, if the platen cover is not securely closed, the edges of the original may be processed as shadows.
	Check if a corner of a thick paper, such as a postcard, scratches the master when it is being printed.	Perform master making again. Use papers that are suitable for this machine. (A 14 "Printing papers")
	Check if a considerable time elapsed for the master roll that was used after the previous master making.	Perform master making again.

Problem	Point to check	Action
<p>The back of the printed paper is smudged with ink.</p> 	<p>Check if the pressure roller is smudged with ink.</p>	<p>Remove the print drum (cylinder), and then wipe the pressure roller with a soft cloth, etc. (A 148 "Maintenance") If the print position deviates from the paper, this may cause the pressure roller to be stained with ink. Adjust the print position within the size of the paper.</p>
	<p>Check if the feed-tray paper guides are fitted to the width of the paper during master making.</p>	<p>When performing master making, align the feed-tray paper guides with the width of the paper. (A 28 "Setting up the paper feed tray and the paper") If the feed-tray paper guides are not aligned with the width of the paper, a master is made in a wider area than the paper size. As a result, ink adheres to the pressure roller outside the paper, and this may cause the ink to be printed on papers.</p>
	<p>Check if a paper that does not efficiently absorb ink is used.</p>	<p>As the next paper is fed before the ink dries, ink adheres to the back of papers. Take the following measures.</p> <ul style="list-style-type: none"> • Use papers that efficiently absorb ink. • Reduce the print speed. [Interval] (A 76) [SPEED] (A 72) • Decrease the ink density. [DENSITY] (A 73) [Contrast] (A 50) [Ink Saving] (A 52)
<p>Printed images are faint. Printed text is blurred.</p> 	<p>Check if printing was performed after the print drum (cylinder) was not used for an extended period of time.</p>	<p>If the print drum (cylinder) is not used for an extended period of time, ink on the surface of the print drum (cylinder) may dry. Printing in such a state may result in faint printing for the first few papers just after the printing has started. Press the [PROOF] key and print several papers before starting actual printing. By executing [Idling Action] (A 92) high print quality may be instantly achieved from the beginning of printing. This can reduce paper waste.</p>
	<p>Check if the original itself is faint.</p>	<p>Darken the contrast in [Contrast] (A 50) and make a master again. For originals written with a pencil, set [Image] (A 47) to [Pencil].</p>
	<p>Check if the temperature is low (below 15°C [59°F]) in the place where this machine is installed or ink cartridges are stored.</p>	<p>Use this machine in a location where the temperature is 15°C (59°F) or higher. For ink cartridges that have been stored in a location at low temperature, keep them in a location at a temperature of 15°C (59°F) or higher before using them. (A 9 "Installation location")</p>
	<p>Check if [Ink Saving] is set to on.</p>	<p>If a master is made while [Ink Saving] is set to on (A 52), the ink on printed papers is lighter than usual.</p>

Problem	Point to check	Action
<p>Although [Multi-Up Print] (multiple-original) was executed, nothing is printed on one side.</p> 	<p>Check if an original was placed while a message that asks you to place the next original was displayed.</p>	<p>If the specified time has elapsed before the second and subsequent originals are placed, master making automatically starts. Any sections that could not be scanned remain as margins. If the time is too short, change [Multi-Up Interval] (A 115) under [Admin.].</p>
	<p>Check if the [STOP] key was pressed while an original was being scanned.</p>	<p>If you press the [STOP] key while an original is scanned, scanning is interrupted. Do not press the [STOP] key until all of the originals are scanned.</p>
<p>The vertical print positions have been shifted.</p>	<p>Check if the vertical print position adjustment dial on the paper feed tray is set to the standard position.</p>	<p>Lower the paper feed tray, and then turn the vertical print position adjustment dial. After adjustment, check the print position on the proof copy. (A 74 “Adjusting the Print Position [PRINT POSITION]”)</p>
<p>Papers are loaded on the print drum (cylinder).</p>	<p>Check if the margin at the top of the printed paper is enough.</p>	<p>The margin at the top of the printed paper (leading edge in the paper output direction) must be at least 5 mm (3/16 inches). Lower the horizontal print position, and then print. If it is not possible to lower the print position, reduce the size of the original to allow enough margin and perform master making again. (A 53 “Enlarging or Reducing the Size of the Original [Size]”)</p>
	<p>Check if the printed paper has a wide solid portion at its top.</p>	<p>If a printed paper has a wide solid portion at its top (leading edge in the paper output direction), papers are more likely to stick to the print drum (cylinder). Set the original upside down and perform master making again. For this operation, it is convenient to use [Rotate] under [Renew Page] (A 76).</p>
	<p>Check if appropriate papers are used.</p>	<p>Use papers that are suitable for this machine. (A 14 “Size and weight”)</p>
<p>Curled printed papers are output.</p>	<p>Check if the paper grain (flow of the grain) is aligned with the paper feeding direction.</p>	<p>Place the paper so that its grain is aligned with the paper feeding direction. (A 15 “To prevent paper jams and paper feeding failures”)</p>
<p>The printed papers that have been output are not neatly piled up in the paper receiving tray.</p>	<p>Check if the positions of the receiving-tray paper guides and paper stopper are appropriate.</p>	<p>Fit the receiving-tray paper guides and the paper stopper to the paper size. For thick papers, slightly widen them. If you have adjusted the vertical position on the paper feed tray, shift the receiving-tray paper guides in the same direction. (A 29 “Setting up the paper receiving tray”)</p>
	<p>Check if the position of the paper-feed setting lever is appropriate.</p>	<p>Select the position of the paper-feed setting lever according to the paper type. (A 28 “Setting up the paper feed tray and the paper”)</p>

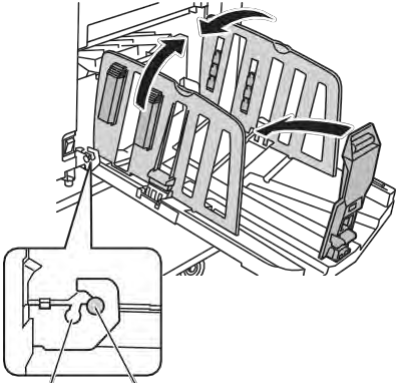
Problem	Point to check	Action
Printed papers go over the paper stopper of the paper receiving tray.	-	<p>Level the paper receiving tray using the following steps.</p> <ol style="list-style-type: none">1 Fold the receiving-tray paper guides and the paper stopper.2 Lift up the sides of the paper receiving tray with both hands, and then move the paper receiving tray shaft to position B of the bearing.  <p>B: When papers go over the stopper A: Normal position</p>

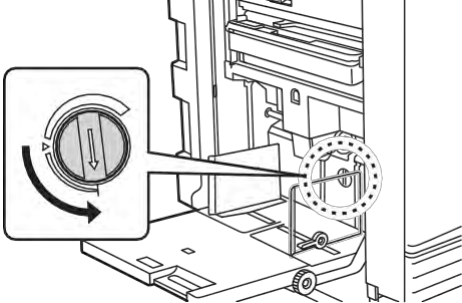
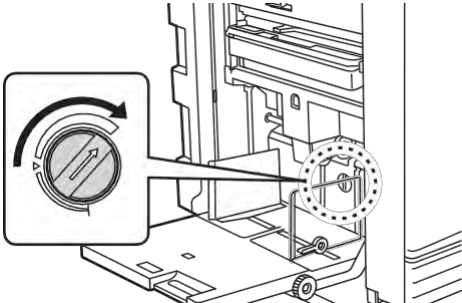
Problem	Point to check	Action
Papers are not smoothly fed from the paper feed tray. (Papers are skipped, or multiple sheets are fed)	Check if appropriate papers are used.	Use papers that are suitable for this machine. (A 14 "Printing papers")
	Check if the position of the paper feed setting lever is appropriate.	When using thick or slippery papers, switch the paper feed setting lever to the position of [CARD]. (A 28 "Setting up the paper feed tray and the paper")
	Check if the angle of the stripper plate is appropriate.	<p>Turn the adjustment dial for the stripper plate angle to adjust the angle of the stripper plate in accordance with the paper conditions.</p> <p>! Before the adjustment, be sure to remove any papers from the paper feed tray, and then confirm that the paper feed tray has lowered to the bottom.</p> <p>■ When papers are skipped Turn the dial counterclockwise.</p>  <p>■ When multiple papers are fed Turn the dial clockwise.</p> 
Check if [Paper Feed Adj.] is set properly.	Set [Paper Feed Adj.] (A 77) as necessary. For appropriate adjustment values, consult your dealer or authorized service representative.	
The printed paper is peeling, or the leading edge becomes wrinkled.	Check if the angle of the stripper plate is appropriate.	Turn the adjustment dial (see above illustrations) for the stripper plate angle to adjust the angle of the stripper plate.

Problem	Point to check	Action
An error message is displayed even though there is no paper jam.	Check if a lifted paper has been output.	The margin at the top of the printed paper (leading edge in the paper output direction) must be at least 5 mm (3/16 inches). Lower the horizontal print position, and then print. If it is not possible to lower the print position, reduce the size of the original to allow enough margin and perform master making again. (A 53 “Enlarging or Reducing the Size of the Original [Size]”)
	Check if this machine is exposed to direct sunlight.	The sensor may malfunction if this machine is exposed to direct sunlight. Shield the light using curtains, etc., in order to protect this machine from direct sunlight.
The print speed cannot be set to [High Speed].	Check if printing is performed in a cold location.	[High Speed] is available when the temperature in the print drum (cylinder) is 5°C (41°F) or higher. If the print drum (cylinder) is cool, increase the room temperature or print at speed [5] for a while, and wait until the print drum (cylinder) is sufficiently warm.
[Quick Master Making] cannot be used.	Check if a function that cannot be used concurrently with [Quick Master Making] is set.	If you set a function that cannot be used concurrently with [Quick Master Making], [Quick Master Making] is set to off. (A 53 “Shortening the Master Making Time [Quick Master Making]”)
Original data with multiple pages have been sent from a computer. Even though multiple copies are set for printing, this machine repeats master making one page at a time.	Check if the [Collate] option is selected in the printing dialog box on a computer.	Temporarily delete the original data that this machine has received. To delete the data, touch [Clear All] (A 23) in the basic screen. Deselect [Collate] in the printing dialog box on the computer, and then resend the original data to this machine. (A 34 “Printing from Computer”)
Even though the computer has sent the original data, this machine cannot receive it.	Check if the [Admin.] screen is displayed on the touch panel of this machine.	Touch [Exit] in the [Admin.] screen to switch to the basic screen.
Although the IP address of this machine is set, the setting changes to [Use DHCP] after the restart of this machine.	Check if the entered IP address is the same as that of another device on the network.	Set a unique IP address.
The display speed of the [Storage] list is slow.	Are there many original data items saved in the same folder?	Delete unnecessary original data or move original data to another folder. (A 66 “Managing the Saved Original Data [Storage], [USB Job List]”)



Chapter 12

Appendix

Optional Accessories

A variety of optional accessories are available to enhance the capabilities of this machine. To purchase the optional accessories, consult your dealer or authorized service representative.

■ Auto Document Feeder AF-VII

Feeds up to approximately 50 pages of originals automatically.

■ Color Print Drum (Cylinder)

Enables the print colors to be changed easily simply by replacing a print drum (cylinder). (Dedicated case included)

■ Wide Stacking Tray

A paper receiving tray that is applicable to paper sizes of up to 310 mm × 555 mm (12 7/32 inches × 21 27/32 inches).

■ IC Card Reader Activation kit RG

Enables individual user management and enhanced security with the use of IC cards.

To use IC cards, [Recognized by] (A 122) must be configured in [Admin.].

■ Job Separator IV;NIII

Enables easy separation of printed papers simply by inserting tape strips when using [Job Separation] function (A 89).

■ Card Feed Kit

A unit for stably feeding paper of the following range of weights.

100g/m² to 400g/m² (27-lb bond to 221-lb index)

■ Envelope Feed Kit

A unit for stably feeding envelopes.

■ RISO Controller IS300

A dedicated controller that enables this machine to be used as a network-connected PostScript 3 printer.

■ RISO Printer Driver for Macintosh

A printer driver that enables the use of this machine on Mac OS.

Specifications

Model	SF9450EII	SF9350EII	SF9250EII
Master Making Methods	High-speed digital master-making		
Master Making Time ¹ (When [Quick Master Making] is OFF)	- Approx. 19 seconds (Letter paper, short edge feed) - Approx. 17 seconds (Letter paper, long edge feed)	- Approx. 20 seconds (A4 paper, short edge feed) - Approx. 16 seconds (A4 paper, long edge feed)	- Approx. 20 seconds (A4 paper, short edge feed)
Master Making Time ¹ (When [Quick Master Making] is ON)	- Approx. 17 seconds (Letter paper, short edge feed) - Approx. 15 seconds (Letter paper, long edge feed)	- Approx. 18 seconds (A4 paper, short edge feed) - Approx. 14 seconds (A4 paper, long edge feed)	- Approx. 18 seconds (A4 paper, short edge feed)
Printing Method	Fully automatic printing		
Scanning Resolution	600 dpi × 600 dpi		
Printing Resolution	600 dpi × 600 dpi When [Quick Master Making] is set: 600 dpi × 400 dpi		
Original Type	Book (10 kg [22 lb] or less) or sheet		
Original Paper Weight	When auto document feeder is used: 50 g/m ² to 128 g/m ² (13-lb bond to 34-lb bond) (normal paper)		
Original Size	When glass platen is used: 50 mm × 90 mm to 310 mm × 432 mm (1 31/32 inches × 3 17/32 inches to 12 7/32 inches × 17 inches) When auto document feeder is used: 100 mm × 148 mm to 300 mm × 432 mm (3 15/16 inches × 5 13/16 inches to 11 13/16 inches × 17 inches)		
Maximum Scanning Area	297 mm × 432 mm (11 11/16 inches × 17 inches)		
Print Paper Weight	46 g/m ² to 210 g/m ² (12-lb bond to 116-lb index)		
Print Paper Size ²	100 mm × 148 mm to 310 mm × 432 mm (3 15/16 inches × 5 13/16 inches to 12 7/32 inches × 17 inches)		
Maximum Printing Area	291 mm × 425 mm (11 15/32 inches × 16 23/32 inches)	291 mm × 413 mm (11 15/32 inches × 16 1/4 inches)	251 mm × 357 mm (9 7/8 inches × 14 1/16 inches)
Paper Feed Tray Stacking Capacity	1000 sheets ³ (stacking height of 110 mm [4 11/32 inches] or lower)		
Paper Receiving Tray Stacking Capacity	1000 sheets ³ (stacking height of 110 mm [4 11/32 inches] or lower)		
Print Speed	6 levels: 60, 80, 100, 120, 130, and 150 (High Speed ⁴) sheets per minute		
Print Position Adjustment	Horizontal: ±15 mm (±19/32 inches) Vertical: ±10 mm (±13/32 inches)		
Image Processing Mode	Line, Photo (Standard / Portrait), Duo (Standard / Line / Photo / Shadow off), Pencil (Darker / Lighter)		

Print Reproduction Ratio	Type: mm Zoom (50% to 200%), Free, 100% reproduction ratio, Margin+ (90% to 99%), 4 levels of enlargement (163%, 141%, 122%, 116%), 4 levels of reduction (87%, 82%, 71%, 61%) Type: inch Zoom (50% to 200%), Free, 100% reproduction ratio, Margin+ (90% to 99%), 4 levels of enlargement (200%, 154%, 129%, 121%), 4 levels of reduction (78%, 65%, 61%, 50%)		
User Interface	Color touch panel		
Functions	Image, Contrast, Size, Paper Size Detection, D-Feed Check, Dot Process, Contrast Adj, Tone Curve, Multi-Up Print, Book Shadow, Top Margin Adj., Binding Margin Adj., Max. Scan, Ink Saving, Quick Master Making, Preview, ADF Semi-Auto ⁵ , Storage, Overlay, Print Speed Adjustment, Print Density Adjustment, Print Position Adjustment, Interval, Renew Page, Auto Page Renewal, Rotate, Special Paper Ctrl, Program, Slip sheet sorting, Job Separation ⁶ , Job Memory, Reservation, Editor, Idling Action, Confidential, My Direct Access, Meter Display, ID Counter Report, Proof Copy, Direct Printing, USB Job List, Paper Memory Print, Scanning Mode, Admin., Auto Sleep, Auto Power-OFF, Power-OFF Schedule, ECO mode, Protect, RISO iQuality System		
Color Change	Print drum (cylinder) replacement method		
Ink Supply	Full automatic (1000 ml/cartridge)		
Master Supply / Disposal	Full automatic (approx. 215 sheets per roll)	Full automatic (approx. 220 sheets per roll)	Full automatic (approx. 250 sheets per roll)
Master Disposal Method	Box type (compatible with vertical disposable type)		
Operating Noise	Max. 65 db (A) (when printing 100 sheets per minute in the operating position)		
Power Source	AC 100-240 V 50-60 Hz <3.4-1.6 A>	SF9350EII AC 220-240 V 50-60 Hz <1.6 A> SF9350EIIA • For Korea: AC 220 V 60 Hz <1.6 A> • For other countries: AC 100-240 V 50-60 Hz <3.4-1.6 A>	• For Korea: AC 220 V 60 Hz <1.6 A> • For other countries: AC 100-240 V 50-60 Hz <3.4-1.6 A>
Power Consumption	When optional accessories are not connected: Max. 300W (Ready: 20 W or lower, Sleep: 5 W or lower, Power-OFF: 0.5 W or lower) When optional accessories are connected ⁷ : Max. 315W (Ready: 30 W or lower, Sleep: 10 W or lower, Power-OFF: 0.5 W or lower)		
Dimensions (W×D×H)	When in use: 1415 mm × 670 mm ⁸ × 1065 mm ⁹ (55 23/32 inches × 26 3/8 inches ⁸ × 41 15/16 inches ⁹) When in storage: 780 mm × 670 mm ⁸ × 1065 mm ⁹ (30 23/32 inches × 26 3/8 inches ⁸ × 41 15/16 inches ⁹)		
Required Space (W×D×H)	1415 mm × 1240 mm × 1515 mm ⁹ (55 23/32 inches × 48 13/16 inches × 59 21/32 inches ⁹)		
Weight	102 kg (225 lb) ¹⁰		
Safety Information	Indoor type, pollution degree 2 ¹¹ , at altitudes of 2000 m or lower		
Optional Accessories	Auto Document Feeder AF-VII, Color Print Drum (Cylinder), Wide Stacking Tray, IC Card Reader Activation kit RG, Job Separator IV;NIII, Card Feed Kit, Envelope Feed Kit, RISO Controller IS300, RISO Printer Driver for Macintosh		

¹ Measurement value when set to 100% reproduction ratio.

- ² When the optional Wide Stacking Tray is installed, you can use paper up to a size of 310 mm × 555 mm (12 7/32 inches × 21 27/32 inches) by setting [Custom Paper Entry]. Depending on the paper type and paper size, papers may not be aligned properly.
- ³ When using the following weight of paper; 64g/m² to 80g/m² (17-lb bond to 21-lb bond)
- ⁴ If the temperature of the inside of the print drum (cylinder) is less than 5°C (41°F), [High Speed] is not usable.
- ⁵ Usable when the optional auto document feeder is installed.
- ⁶ Usable when the optional Job Separator is installed.
- ⁷ When all the following optional accessories are installed.
- Auto Document Feeder
 - Job Separator
 - IC Card Reader
- ⁸ The depth does not include the stabilizers for the dedicated rack.
- ⁹ The height includes the dedicated rack.
- ¹⁰ The weight does not include the ink, master roll, and rack.
- ¹¹ The pollution degree of the usage environment due to dirt and dust in the air. Degree “2” corresponds to a general indoor environment.

Notes

- The specifications and type of the product are subject to change without prior notice.
- Please note that due to improvements and changes to this machine, some images and explanations in this guide may not correspond to your machine.

Index

Numerics

[U] key.....	21
[+] key.....	21
[V] key.....	21
[I] icon	136
2 Up.....	60

A

[Active] tab screen.....	132
ADF Auto Process.....	112
ADF cover.....	20
ADF original guides	20
ADF original receiving tray	20
ADF Semi-Auto	64, 112
Admin.	110
Administrator.....	124
Authentication function.....	122
Authentication operation	43
Authentication registration numbers	124
Authentication screen	22
Auto Clear.....	115
Auto Document Feeder.....	20
Auto Idling.....	116
Auto Page Renewal.....	77, 116
Auto Power-OFF.....	115
Auto Process.....	25, 33, 35, 41, 64
[AUTO PROCESS] key.....	21
Auto Process Mode	112
Auto Sleep	115

B

Beep Sound.....	116
Binding Margin Adj.....	62
Blocked.....	23
Book Shadow.....	51

C

[C] key.....	21
Clear All	23
Clock/Calendar.....	114

Confidential	93
Consumables.....	12
Consumables Amount.....	136
Consumables Information Input Wizard.....	159
Contrast.....	50
Contrast Adj.....	49
Control panel	18
Copy Count Mail	116
Copy/Move	67
Create User	124
Custom Paper Entry.....	114, 119

D

Data-Map	23
Date and Time	137
DENSITY.....	73
[DENSITY] keys.....	21
D-Feed Check.....	81
DirectAccess Entry.....	111, 117
Directory.....	105
Disable.....	125
Display Adjustment	111
Display Priority.....	111
Displayed Language.....	111
Disposal Box Space.....	137
Dot Process.....	49
Double Feed Check	112
Drum Information	137
Duo	47

E

ECO mode.....	115
Editor.....	84, 116
Error.....	23
Error diffusion method	49
Error message	152
Ex. Reserve Period	115
Extended paper	55
External Controller	114

F

Feed tray ascent / descent button.....	18
Feed-tray paper guides.....	18
File Name.....	105
Fixed Scan Size.....	114
Folder Renaming.....	114
[Folder] tab screen.....	133
Format.....	107
Free.....	53
Front door.....	19

G

Gauge cover.....	51
[General] tab screen.....	131
General user.....	124
Glass platen.....	18
Group.....	125

H

High Speed.....	72
[HOME] key.....	21
[HOME] screen.....	22
Horizontal direction.....	74

I

IC Card.....	123
ID Counter Report.....	96
ID data.....	43
ID Print.....	106, 122
ID Print Job.....	43, 106
Idling Action.....	92
Image.....	47
Image Processing.....	112
Initialize Network.....	116
Ink cartridge.....	19
Ink Information Input.....	159
Ink Saving.....	52
Interval.....	76

J

Job Count.....	95
Job List.....	23, 35
Job list display.....	111

Job Memory.....	90
Job Separation.....	23, 89, 112
Jump Wing Control.....	81, 112

L

LAN port.....	18
Limit.....	125
Limit M/C.....	126
Limit T/C.....	126
Line.....	47
Logging in.....	130
Low/Admin Tab Only.....	123

M

Machine authentication.....	122
Management Level.....	123
Margin+.....	53
Margin-Plus Rate.....	114
Master disposal box.....	18
Master guide flap.....	19
Master Information Input.....	161
Master making.....	46
Master making area.....	16
[MASTER MAKING] key.....	21
Master making process.....	25, 64
Master making unit.....	19
Master making unit cover.....	19
Master making unit handle.....	19
Master Making Unit Release Button.....	19
Master roll.....	19
Master roll holder.....	19
Max. Scan.....	56
Maximum Printing Area.....	16
Memory card.....	38
Memory card slot.....	18
Message area.....	22
Meter Display.....	95
Metric/Inch Switch.....	111
Minimum Print Q'ty.....	116
[Monitoring] Menu.....	131
Multi-Page Mode.....	85
Multiple-Original.....	57
Multi-Up Interval.....	115

Multi-Up Print	56
Multi-Up Tickets.....	56
My Counter	137
My Direct Access.....	94

N

[Network] Menu	133
[Network setting] screen.....	133
Network Settings (IPv4)	114, 121
Network Settings (IPv6)	114, 121
Non-ID Print	106
Numeric display	21
Numeric keys	21

O

OFF/Delete	127
Offset.....	76
Output.....	67
Overlay	68
Owner	106

P

[P] key.....	21
Padlock.....	128
Page Orientation.....	116
Paper	55, 119
Paper arranger knob.....	19
Paper Eject Adj.....	78
Paper Ejection Adj.....	113
Paper Feed Adj.	77
Paper feed setting lever	18
Paper feed tray.....	18
Paper grain	15
Paper jumping wing.....	19
Paper Memory Print.....	64
Paper receiving tray.....	19
Paper Size	55
Paper Size Detection	114
Paper stopper.....	19
Password	130
Pause	23
Pencil.....	48
Photo	47

PIN code	122
Platen cover.....	18
Platen cover pad.....	18
Power switch	19
Power-OFF Schedule.....	115
Present M/C.....	126
Present T/C	126
Pressure roller	150
Preview	23, 63, 67
Print Colors.....	116
Print Density	73, 112
Print drum (cylinder).....	19
Print drum (cylinder) handle.....	19
Print Drum (Cylinder) Release Button.	19
[PRINT] key	21
Print Position	74
[PRINT POSITION] keys	21
Print Speed.....	72, 112
[Printer] Menu	132
Printing.....	25, 72
Printing area	16
Printing process	25, 64
Program	84
Proof copy	25
[PROOF] key	21
Protect.....	116, 128

Q

Quick Master Making	53, 113
---------------------------	---------

R

READY.....	23
Receiving-tray paper guides	19
Recognized by.....	122
Register marks.....	61
Rename.....	24
Rename Group	127
Renew Page	76
Report Output.....	96
Reproduction Size.....	112
Reservation	92, 115
Reserve Period	92, 115
Reset Counter.....	127

[RESET] key.....	21
RISO Console	130
RISO Printer Driver.....	13
RISO Utility Software	13
Rotate	67, 76

S

Scan Data Folder.....	113
Scanning.....	39, 104
Scanning Contrast.....	112
Screen printing method.....	25
SD card.....	38
SDHC card.....	38
Selections	111, 118
Service contact.....	111
Service Info. Mail	116
Set Date.....	97
Single Page Mode	84
Single-Original.....	56
Size	53
Skip Page.....	23
Slip sheet sorting	89
Slip sheet sort set.....	112
[SMTP Setting] screen	134
[SNMP Setting] screen.....	134
Special Paper Ctrl.....	77
SPEED.....	72
[SPEED] keys.....	21
Stabilizer	19
Standard ratio.....	53
[START] key.....	21
Start-Up Screen.....	111
[STOP] key.....	21
Storage	38, 40
Storage Retrieve.....	67
Storage Selection	68
[Storage] tab screen	132
Stripper plate adjustment dial	169
Supply contact.....	111
[System] tab screen.....	131

T

Thermal print head.....	19
-------------------------	----

Tone Curve.....	50
Top.....	14, 16
Top Margin Adj.	61
Total counter.....	95
Touch panel.....	21

U

USB flash drive.....	13
USB Job List.....	66, 68, 69
USB port.....	18, 19
USB print (Auto process).....	40, 42
User Management	115, 122
User name.....	130
[User] tab screen.....	131

V

Vertical direction	74
Vertical print position adjustment dial	18, 74
View edit.....	43

W

[WAKE-UP] key	21
---------------------	----

Z

Zoom.....	54
-----------	----

Notice for Republic of India

RISO complies with the e-waste (Management and Handling) Rules “e-waste Rules”.

What is the “e-waste Rules”?

The purpose of the “e-waste Rule” is to reduce waste and ensure Electrical Equipment is recycled at the end of life.

RISO declares our products comply with the “India E-waste Rule” and prohibits use of lead, mercury, hexavalent chromium, polybrominated biphenyls or polybrominated diphenyl ethers at or over a concentration of 0.1% by weight or at or over 0.01% by weight for cadmium, except for the exemptions set in Schedule 2 of the Rule.

You can't dispose of our used products as household waste. Used products contain many hazardous substances which may have a serious, detrimental effect on the environment and/or human health.

What does the crossed out wheeled bin symbol mean?

The crossed wheeled bin symbol indicates this product must be disposed of separately to household waste.



“e-waste Rules” shall apply to products including their components, consumables, parts and spares needed to function properly.

Who should I contact if I want more information about the “e-waste Rules”?

You should contact Riso India Pvt.Ltd.

Email: product-recycling@risoindia.com ; Tel : 0120-4721300

Notice for European Union Member States

RISO, the environment and the Waste Electrical and Electronic Equipment Directive "WEEE Directive"

What is the WEEE Directive?

The purpose of the WEEE Directive is to reduce waste and ensure Electrical and Electronic Equipment is recycled at the end of its useful life.



What does the crossed out wheeled bin symbol mean?

The crossed out wheeled bin symbol indicates this product must be disposed of separately to normal waste.

Please contact your RISO service agent for information about disposal.

What does the solid bar symbol mean?

The solid bar under the crossed out wheeled bin indicates this product was put on the market after the 13th August 2005.

Who should I contact if I want more information about the WEEE Directive?

You should contact your local RISO service agent for more information.



Please contact the following for supplies and service: